

The technology of tomorrow for general lighting applications.

Nov/Dec 2008 | Issue

10

LED System Simulation and Testing

Measurement Standards and Guidelines
LED Source Modeling
Simulating Device Thermal Performance

LED Encapsulant Epoxy Curing

free version
low resolution
view only



LIGHTING FOREVER

About Everlight Electronics

Everlight Electronics Co. Ltd is a leader in the design of LEDs, Display, Infrared and Optocoupler components serving various applications in the consumer, computing, automotive, telecommunication and industrial market segments. Everlight's visible LED portfolio consists of LAMPs, Flash LEDs, and SMD LEDs; Infrared portfolio includes both through-hole and SMD packaged standard and High Power Emitters, Phototransistor and Photodiode Sensors, Reflective and Transmissive Sensors. Everlight's exponential growth is the combined result of its well-engineered products, highly efficient in-house manufacturing facilities and extensive global supply chain.

Founded in 1983, Everlight is headquartered in Taipei, Taiwan, with operations in Asia, America and Europe.

For more information about the company and products, Please visit our website at www.everlight.com

The Professional Manufacturer of LED Industry



EVERLIGHT ELECTRONICS CO., LTD. www.everlight.com

• Taipei Headquarters
TEL: +886-2-22672000
E-Mail: spd@everlight.com

• America Office
TEL: +1-972-490-4008
E-Mail: salesmkt@everlight.com

• Europe Office
TEL: +49-721-824-473
E-Mail: info@everlight-eu.de

Innovative Illumination with LEDs



The 6th VDI conference about "Innovative Illumination with LEDs" took place in Düsseldorf, Germany on the 18th and 19th of November, 2008. VDI is the association of German engineers and the conference covered the actual market as well as technology trends in the LED lighting domain, also focusing on white LED developments. Leading experts from LED manufacturers and from lighting producers attended the two-day conference.

The white light LED applications show the highest market growth rate nowadays, but with \$325M USD (2007), only about 2% of the worldwide illumination business is covered by LED solutions. The market potential is very high, especially when considering the legal relegation of the inefficient incandescent lamps.

LED and lighting module manufacturers continuously improve white LED parameters. The reduction of binning classes is one big target. Besides the reduction of phosphor mixture tolerances, manufacturers selectively combine LED dies with a suitable phosphor carrier in their production process, to reach accurate CCT areas. In high-end applications like aerospace and automotive, the quality of the white light from LEDs is not sufficient yet. Even with binning optimization processes, color problems occur in combination with secondary optics because of unequal spectral distributions.

The efficiency values are continuously improving. LEDs with more than 100lm/W are available on the market in high volume, but the manufacturers pointed out that efficiency and CRI/CCT will remain a major contradiction in the development of white LEDs. The further improvement will go faster with high-current, high-power LEDs compared to the development steps in the lower-current area. But the efficiency values will also come into saturation within the next few years. Efficiency values of about 150lm/W @ CRI 80 can be seen as a next target value they are facing, but a lot of work has to be done to reach this goal.

The VDI conference clearly showed that the LED lighting is entering the illumination market and comes only from niche applications. Multi-Chip LED solutions for replacing the incandescent lamps or LED lighting modules, in which the LED technology is embedded in a system are forcing this fast development. On the other hand, there is still confusion in the market based on "incomparable" or insufficient figures from some LED manufacturers. This concerns the need for common measurement standards, but often missing data, like the lifetime of LEDs, regarding the reduction of the lumen output and the shift in color temperature or spectrum, should be included in datasheets.

In addition to the quality improvements of LEDs we should not forget to reduce the system costs, because today the pay-back time with a range from three to eight years is still too long for a real market breakthrough.

Innovative illumination with LEDs requires a system in which the LEDs, the primary and secondary optics, the electronic driver and supplies, the thermal management devices and last, but not least, the mechanics with its design, are carefully chosen. More and more the different system-components merge together, building complete innovative sub-units of lighting systems with the advantage of easy handling for the OEMs.

The development of these sub-units requires multi-domain approaches and therefore multi-domain tools to model and verify such LED lighting systems.

The November/December 2008 LED professional Review (LpR) issue highlights LED simulation and measurement topics showing how these methods can be applied to modern LED lighting systems.

We would be delighted to receive your feedback about LpR or tell us how we can improve our services. You are also welcome to contribute your own editorials.

Yours Sincerely,

A handwritten signature in black ink, appearing to read 'Siegfried Luger', written over a horizontal line.

Siegfried Luger

Publisher

Imprint

LED professional Review (LpR)

ISSN 1993-890X

Publisher

Luger Research e.U.
Institute for Innovation & Technology
dep LED professional
Rhombergs Fabrik
A 6850 Dornbirn, Austria / Europe
phone +43 5572 394 489
fax +43 5572 394 698
editors@led-professional.com
www.led-professional.com

Publishing Editors

Siegfried Luger
Arno Grabher-Meyer
Chrystyna Lucyk

Account Manager

Silvia Girardelli

Front-page picture

GaN based UV-LED testing
© FBH/schurian.com

Copyrights – Luger Research e.U.

The editors make every reasonable effort to verify the information published, but Luger Research e.U. assumes no responsibility for the validity of any manufacturers, non profit organisations or individuals claims or statements. Luger Research e.U. does not assume and hereby disclaims any liability to any person for any loss or damage caused by errors or omissions in the material contained herein, regardless of whether such errors result from negligence, accident or any other cause whatsoever. You may not copy, reproduce, republish, download, post, broadcast, transmit, make available to the public, or otherwise use of LED professional Review (LpR) content without the prior written permission from Luger Research e.U. – Institute for Innovation & Technology, Austria. ■



LED professional Review (LpR) – Subscription

LpR Digital Magazine – free version

- pdf download
- view only, low resolution
- private use

LpR Digital Magazine – full version annual subscription

- pdf download
- pictures and graphs in high resolutions, printable
- 6 issues
- access to all previous issues
- commercial use
- Euro 78.80

LpR Printed Magazine – annual subscription

- 6 issues
- Euro 158.40

Send E-mail to:

editors@led-professional.com

Next LpR Issue – Jan/Feb2009

- LED Electronics

Content

Editorial	p1
Imprint	p2
Product News	p5
Research News	p10
IP News	p12
Correction	p12

■ Characterization	
LED Lighting Technology Fundamentals and Measurement Guidelines by M. Nisa Khan, Ph.D., LED Lighting Technologies	p14
CIE 1964 Colorimetric Observer Chart Improves White Light Quality by Peter Pachlar, Tridonic Atco Optoelectronics	p16
White Light LEDs – Importance of Accepted Measurement Standards by Dr. Thomas Nägele; Instrument Systems GmbH	p22
The Role of Miniature Spectrometers for LED Measurements by Jorge Macho, Ocean Optics	p26
■ Technology	
LED Encapsulant Epoxy Curing Optimization by Bit Tie Chan, Avago Technologies	p30
■ Optics	
LED Source Modeling Method Evaluations by Mark Jongewaard, LTI Optics and Kurt Wilcox, Ruud Lighting	p34
Simulation and Optimization of Optical Systems by Dr. Norbert Harendt, IB/E OPTICS and Christoph Gerhard, LINOS Photonics	p40
■ Thermal Management	
Simulating Device Thermal Performance Using PLECS by Dr. John Schönberger, Plexim GmbH	p44
■ Annual LED professional Review (LpR) Article Index 2008	p46

Advertising Index

EVERLIGHT	p C2
OPTICAL RESEARCH	p 4
OSRAM	p 13
INSTRUMENT SYSTEMS	p 19
SAMSUNG	p 21
ROAL LIVING ENERGY	p 33
POWER VECTOR	p 33
EDISON	p 35
LED TAIWAN 2009	p 39
LED CHINA 2009	p 43
INTERNATIONAL RECTIFIER	p C3
TRIDONIC.ATCO	p C4

Optimize With LightTools

Design, Analyze, Optimize and Deliver

Model any illumination system with *LightTools*' powerful design, analysis, and optimization features.

Design

Interactive point-and-shoot ray tracing, extensive libraries of optical elements, seamless information sharing with CAD programs, and modeling of real-world optical effects—such as polarization, scattering, and color filter performance—are just a few of *LightTools*' comprehensive design features.

Analyze

LightTools' fast, reliable Monte Carlo ray tracing and full suite of simulation tools help you explore design alternatives, study light behavior, and identify and fix potential problem areas early in the product development process.

Optimize

LightTools' fully integrated illumination optimization capability automatically creates the best design within the design space. New features meet evolving industry needs.

Deliver

Deliver illumination systems that meet project specifications and schedules every time.

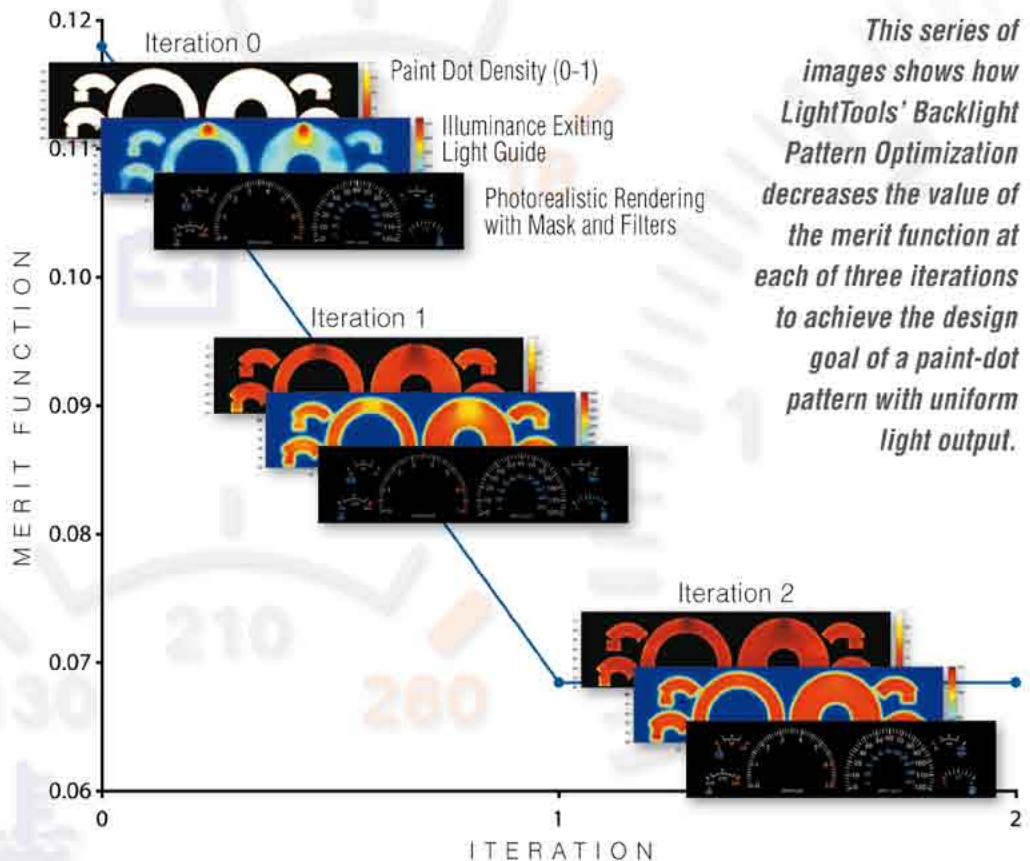

*This series of images shows how *LightTools*' Backlight Pattern Optimization decreases the value of the merit function at each of three iterations to achieve the design goal of a paint-dot pattern with uniform light output.*

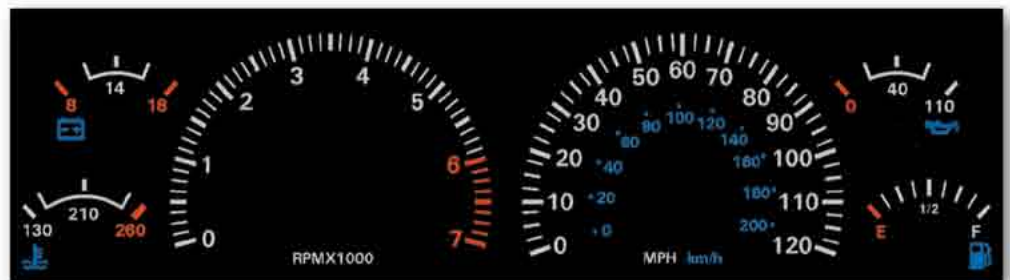

Final Result : Iteration 2

New Optimization Features

- **Backlight Pattern Optimization** for automatic design of backlight extraction patterns for LCDs, cell phone key pads, and automotive instrument clusters.
- **Parameter Sensitivity** analysis for selecting the best set of variables prior to system optimization.
- The **SolidWorks® Link Module** for dynamic linking of SolidWorks models to *LightTools*, where you can optimize optical elements, parts, and assemblies.

LightTools®

www.opticalres.com

OPTICAL
RESEARCH
ASSOCIATES

Corporate Headquarters: 3280 East Foothill Boulevard, Pasadena, CA 91107-3103 (626) 795-9101
Fax (626) 795-0184 **E-mail:** info@opticalres.com **Web:** www.opticalres.com
Offices: Tucson, AZ | Westborough, MA

Product News

Zenigata Line-Up: Sharp Introduces a New Series of High-Power LED

Right on time for *electronica*, Sharp introduces a new series of high-power LED modules for lighting purposes. With a lighting performance of up to 540 lumens, the new "Zenigata" modules make a direct leap into the category of the 60W equivalent lamps with a power consumption of only 6.7 watts. Thanks to the light yield of up to 80 lumens per watt (depending on the module), the LEDs from Sharp are amongst the front-runners today in the field of energy efficiency in LED lamps. In addition to their superb energy efficiency, 40,000 operating hours at an operating temperature of 80°C also ensure that the overall system costs stay low.

Divided into sixteen parallel-switched series of three, the modules of the 540 lumen series are built up in a matrix of 48 LED dyes that provide an overall light output of between 350 and 540 lumens, depending on the module. In contrast, the LED modules of the 280 lumen series consist of ten parallel-switched series of three with a total of 30 LED dyes. They provide a light output of 190 to 280 lumens. For both series (540 and 280 lumens), an aluminium-ceramic plate measuring 18 x 18 x 1.5 millimetres is used as a substrate. Already equipped with mounting drill holes it is possible to fix the modules securely to a suitable cooling element without great effort.

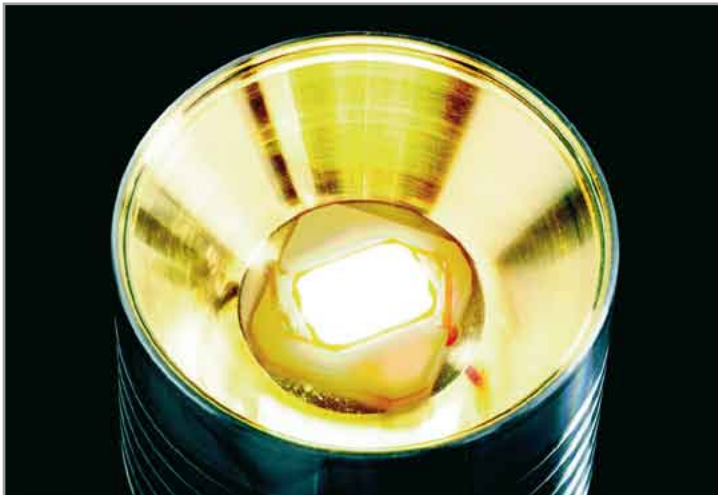

The Zenigata LED lighting module series, the core of Sharp's LED Lighting products

The colour temperature of the white light LED lighting module from Sharp lies within a range of 2,800 to 6,500 kelvins with the defining tones of "normal white light", "warm white light", comparable to a light bulb and two types of "high colour rendering white", attaining a CRI value of 90 and thus providing high colour veracity and detail fidelity. ■

Cree Announces Commercial Availability of XLamp MC-E

Cree, Inc. (Nasdaq: CREE), a market leader in LED lighting, announces the commercial availability of the XLamp(R) MC-E LED, the highest-lumen LED in the award-winning XLamp family.

The multi-chip XLamp MC-E retains the same 7mm x 9mm footprint as Cree's existing XLamp XR family LEDs while providing four times the light output of the existing XR-E; it is the highest lumen output commercially available for a package of this size. This powerful combination is designed to enable new applications and reductions in overall system cost compared to other LED packages. At 9.8W, the XLamp MC-E LED provides up to 790 lumens at 6000K and up to 605 lumens at 3000K.



The multi-chip XLamp MC-E retains the same 7mm x 9mm footprint as Cree's existing XLamp XR family LEDs

"Cree's XLamp MC-E LED is a lighting-class solution for applications that require high lumen output in a small footprint," said Norbert Hiller, Cree Vice President and General Manager for lighting LEDs. "Imagine the design implications for something like a street light, if you could reduce the size by roughly 75 percent without compromising on lumen output. Or consider the efficiencies that could be gained in an MR16 bulb application."

The MC-E has already been designed into a number of products and applications, as customers can benefit from increased design flexibility and reduced overall system cost over other, lower flux-output LED packages, without compromising on quality. ■

Avago Adds 3-Watt Moonstone to Portfolio

At the Electronica - Munich, Avago Technologies, a leading supplier of analog interface components for communications, industrial and consumer applications, announced the addition of the new 3-Watt high power Cool-White (ASMT-Mx20) and Warm-White (ASMT-Mx22) low-profile LEDs to its Moonstone family. Avago's ASMT-Mx20/-Mx22

surface-mount LEDs, which target designers of solid-state lighting applications, are capable of being driven at high currents with typical light output of 145 lumens (lm) of illumination to deliver one of the best output performances in the industry. These 3W LEDs are ideal for use in streetlights, architectural, portable, retail, and lighting applications.

Features:

- Long operating life
- Energy efficient
- High flux output: delivers 145 lm typical @ 700 mA drive current
- Electrically isolated heat sink is available
- Heat and UV-resistant silicone encapsulation
- ESD resistance: 16kV
- Moisture sensitivity level (MSL) 4
- Pb-Free and RoHS compliant



The 3-Watt Moonstone is pin-compatible to the whole Moonstone series

Avago's ASMT-Mx20/-Mx22 Moonstone LEDs offer a wide 120-degree viewing angle, good color and light output uniformity, and low thermal resistance to maintain long-term device reliability. Moreover, the low-profile design of these LEDs is ideal for use in applications where height is a constraint. The ASMT-Mx20/-Mx22 are compatible with standard surface-mount technology (SMT) reflow soldering processes and provide designers with easy handling and more flexibility during assembly. ■

ENFIS Launches World's Brightest LED Array

The world's brightest LED Enfis Quattro, which generates 12,000 lumens from a single LED Array, has been launched by Enfis, global leader in light engines and arrays. Introduced at PLASA 2008, it is composed of an LED array, optics, thermal management and electronics, and enables designers to get on the market faster. The light engine provides a stable, intelligent platform for the design, development, test, and manufacture of lighting systems.

Its unique combination of high-power, simple integration and smart array technology provides lighting designers with user-friendly, highly-efficient, high powered single and multi-colour light sources.

Enfis' arrays and light engines are available in four platforms: the QUATTRO, Enfis' premium high-output product; QUATTRO MINI (up to 5,000 lumens), the UNO PLUS (up to 1,400) lumens, and the UNO (up to 1,000 lumens). The QUATTRO Mini and UNO Plus are available either as single colour/white or as RGBA, RGBW or High CRI (Ra>90) variable CCT.

Enfis received prodigious interest during and after this year's PLASA 08 Show at Earls Court, London, particularly from those engaged in the development of complete lighting fixtures around a true, high power LED module, for Architainment, Entertainment and display lighting. ■

CeramCool® Optimized for 4W Cooling

The optimized geometry allows operation of a 4W LED at a maximum temperature of 60°C and reduces the temperature at the hot-spot by 6°C resulting in a significant reduction of stress on a critical component. This means the thermal resistance of the Rubalit ceramic assembly for an identical shape is 13% better than aluminum. With CeramCool® Alunit the improvement even reaches 31%. The new design is square in shape and comprises longer, thinner fins with a larger spacing.

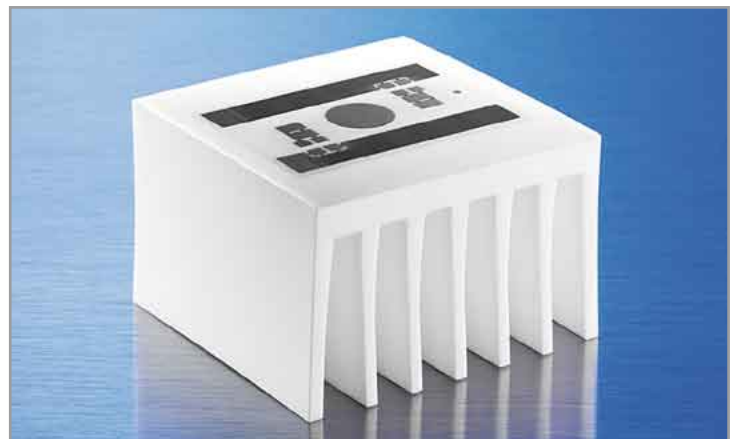

Optimized CeramCool® geometry for 4W cooling

The CeramCool® ceramic heat sink is an effective combination of circuit board and heat sink for the reliable cooling of thermally sensitive components and circuits. It enables the direct and permanent connection of components, such as high-power LEDs and ceramic heat sinks. In comparison to conventional systems that mostly have numerous layers (adhesives, insulating materials) and widely varying thermal expansion coefficients, the assembly process is reduced, the device is made smaller and thermal conductivity measurably improved. Long-term stability and system reliability increase. Also, ceramic is electrically insulating

per se and can provide bonding surfaces by using metallization pads. Customer-specific conductor track structures can also be provided. This turns the heat sink into a module substrate that can be densely populated with components. Individual forms can be manufactured and optimized according to customer specifications.

MCPCB for Achrice for the EU

GK Technik announced, that they have designed a new MCPCB, which fits the Achrice LED from Seoul Semiconductor, in the 230V-Version 322x and 323x.



Achrice MCPCB fits all lenses without modifications

"We have made a very careful, new design, to continue the VDE-, CE- and TUV proven design from SSC", states Mr. Juergen Krueger, co-founder of Fa. GK Technik. "The new aluminum MCPCB can be directly connected to 230V AC. With a creepage of 6.3mm, we address the needs of those customers who make very reliable and safe products."

The new MCPCB is a combined design. It contains the needed resistors and fits the available lenses of 26,5mm diameter. The shape is an octagon with a side-to-side distance of 35mm. It contains two holes for M3-screws. This new octagon MCPCB can be mounted together with all available lenses without modifications. The panel contains 30 pieces of this MCPCB. GK Technik also provides support for your own OEM-design. ■

New Copper LED Mounting Boards Accept Optical Solutions

Introducing copper mounting boards for Cree XR, XP, and MC-E LEDs and one new board for the Luxeon Rebel. Each board accepts a single LED and an optional 22mm optical package.



Copper mounting boards for Cree XR, XP, and MC-E LEDs, and Luxeon Rebel

AsianSignals released the first copper clad boards for the Luxeon Rebel a year ago, and through testing and use, customers are pleased to report that copper is outperforming aluminum clad boards. These boards are not only made from better thermal materials, but the LEDs are bonded to the underlying heat sinks with solder, rather than glue resulting in more solid heat transfer characteristics. The entire thermal pathway is metallurgically bonded. On aluminum MCPCBs, the LED thermal pathway is inhibited by two adhesive barriers. Additionally, dielectric layers can't compete with a copper path for thermal efficiency.

To further benefit the design, copper plated screw holes are strategically placed near the LEDs. The mounting screws facilitate heat sinking by creating an even "pressure line" right under the LED.

The 3oz copper top and bottom layers are gold plated for a beautiful finish. Drilling template are also available for these boards.

22mm optical lenses from LEDiL.com and Fraen may be used on these products; however, holes will have to be hand-crafted into the plastic lens holders so, that they can be adapted to the boards. ■

GK Technik Provides New Four-String HB LED Driver

Maxim Integrated Products (NASDAQ: MXIM) introduces the MAX16826 programmable, four-string high-brightness (HB) LED driver for white, RGB, and RGB-plus-amber LED configurations. Designed to enable the transition to green lighting technology in automotive applications, this device maximizes system flexibility and provides the lowest solution cost for backlight drivers.

The MAX16826 integrates a switching regulator controller; a 4-channel, linear current-source driver; an ADC; and an I²C interface. The I²C interface allows dynamic programming of the output voltage to maximize power efficiency; it also allows manufacturers to program LED currents for each string to accommodate LED binning variations, thereby reducing implementation costs.

Offering an unparalleled combination of configurability and performance, the MAX16826 is ideal for backlighting automotive infotainment displays, automotive display clusters, industrial and desktop monitors, and LCD TVs. It is also well-suited for adaptive front lights and low-/high-beam assemblies, as well as other solid-state lighting (SSL) applications. ■

Power Vector's New TRINITY 6™

Power Vector's new developed 240-watts LED Driver with improved dimming opportunities is currently available for prototype evaluation in limited quantities. UL and CE approved production units are targeted for January 2009.

Power Vector's New TRINITY 6™ LED Driver Dimmer combines Power Isolation with a 240-Watt power supply, Analog or DMX 512A Dimming and Constant Current outputs for driving and dimming LED fixtures. The TRINITY 6™ is able to drive and dim 6 LEDs per channel (up to 27 VDC and up to 72 LEDs). The product can drive 700Ma, 1A, and 1.4A LEDs and is ideal for high-powered applications in both architectural and entertainment applications.

TRINITY 6™ provides low-level dimming to 0.23 percent brightness. This feature is especially important for designers who use other lighting sources and require fluid dimming. Other products typically drop off at 10% leaving a harsh step at the low end of the dimming sequence.



Power isolated TRINITY 6™ LED Driver Dimmer

Power Vector is pleased to offer an Analog dimming option for the first time, for customers looking to dim their General Illumination or Monochromatic fixtures. Power Vector's simple solution enables a simple connection from a 0-10VDC Slide or Rotary dimmer to the TRINITY 6™ and then to the LED Fixture; no magic boxes, extra cabling, or extra costs. DMX is strongly recommended for color changing applications or where a large network installation are required. Power Vector's products follow the USITT DMX512A standard.

TRINITY 6™ is a completely enclosed, convection-cooled, fan-free, solution complete with mounting tabs, flying leads, and an input voltage of 115 Vac to 277 Vac. The unit provides output protection for

overvoltage, overcurrent, and short circuit protection. The unit also offers overtemperature protection, throttling back to 25% when ambient temperatures are exceeded. ■

Lagotronics: New DecaLED® Controller 3 Mini

Lagotronics introduces the new DecaLED® Controller 3 Mini. The DecaLED® Controller 3 Mini is designed for 24VDC led installations, in which the power and eight outputs of the DecaLED® Controller 3, or the high-amperage outputs from the DecaLED® Controller 4 aren't needed.



DecaLED® Controller 3 Mini

The DecaLED® Controller 3 Mini has a 100W PSU and two outputs with screw terminals. The DecaLED® Controller 3 Mini is ideal for installations in smaller venues in which fully RGB-lit led products are requested. More information on the DecaLED® Controller 3 Mini and the products that may be used in conjunction with the controller can be found on the dedicated product page.

The DecaLED® Controller 3 Mini offers a solution for dimming all 12VDC products. The DecaLED® Controller 3 Mini is ideal for installation in small and narrow service rooms. The controller 3 mini combines a driver with a 100W PSU.

The DecaLED® Controller 3 Mini is a small version of the DecaLED® Controller 3 and the lightest of all 24VDC controllers. The Controller 3 Mini is a professional LED controller for LED products with a 24VDC input. The DecaLED® Controller 3 Mini is suited for powering and dimming of all 24VDC LED products and can handle a maximum load of 6Amps, with a maximum of 3Amps per output. The controller is 243 x 150 x 73 mm and needs a input voltage of 230VAC. The DecaLED® Controller 3 Mini is delivered with a remote control and an external infrared eye. With these accessories and the dipswitches it is possible to select a diversity of standard programs, colours and effects. The Controller 3 Mini is also equipped with professional XLR 3 connector and screw terminals for DMX signals.

There are various accessories available for the DecaLED® Controller 3 Mini like starter cables, spare remotes, spare infrared eyes and the DecaLED® Setup Tool. ■

Eyeleds Launches New ,Outdoor Extreme'

Eyeleds International is happy to announce the official market release of the latest Product Innovation 'Eyeleds Outdoor Extreme'.

Eyeleds International offers ultra-slim, sustainable, 'plug-and-play' LED lighting solutions for application in both indoor and outdoor environments. The current product range is used in both end-consumer and professional projects for orientation, design and functional purposes.



The new, robust EyeLEDs 'Outdoor Extreme'

Considering the application of Eyeleds in outdoor environments, Eyeleds currently offers the successful Outdoor 'Basic' and Outdoor 'Professional' series. Current developments in especially the project market demand an even more robust LED lighting solution, thanks to the growing awareness of the added value of LED products for large-scaled landscape projects.

The new Eyeleds Outdoor Extreme is an innovative response to the market latest demand. The product is able to operate – as the product's name assumes – under extreme circumstances. Therefore, application in 'heavy' loaded projects, such as airports, traffic areas, squares, shopping areas, etc. pose no problem. ■

Advanced Lumonics: LED Bulbs

Advanced Lumonics introduces EarthLED ZetaLux a new, low cost, direct replacement LED Light bulb that uses only 7W. ZetaLux offers advanced features that make it ideal for use in general lighting applications.

Following the success of the EvoLux launch earlier this year, the EarthLED ZetaLux LED light bulb offers a price/performance ratio unmatched in the industry. The ZetaLux only consumes 7W yet offers performance comparable to a 50-60 watt light bulb. With a price of under 50 USD, the ZetaLux offers an unprecedented payback time of just over two years when operated eight hours per day.

ZetaLux is built upon the latest LED engine technology from CREE® allowing for amazing efficiency, high output and a new benchmark in Color Rendering Index (CRI) performance. CRI is a good way to determine the quality of light and its faithfulness to render colors correctly, EvoLux features a CRI of 75 for cool white and 80 for Warm White, making them exceptional for LED Light Bulbs.



The new 7W EarthLED ZetaLux delivers 450lm (Cool White), 350lm (Warm White)

The ZetaLux has been designed to the most exacting standards of any LED light bulb currently on the market. From its oversized aluminum heat sink to its flame retardant plastic, to its shatter-proof lens, the ZetaLux is built to perform safely and efficiently for over 50,000 hours. The ZetaLux's rugged design also allows it to perform under the harshest conditions including frigid -50 degree frost all the way up to scorching 180 degree heat and 95% humidity.

Advanced Lumonics is also announcing enhanced versions of their successful EvoLux line. All EvoLux bulbs now feature lumen outputs exceeding 1000 Lumens along with a higher CRI and even greater efficiency. These enhancements further cement the position of EvoLux as the most advanced direct replacement LED light bulb on the market today. The ZetaLux, along with the new enhanced EvoLux, will be among the first direct replacement LED light bulbs to achieve UL certification later this year, along with compliance with new DOE EnergyStar standards for LED lighting in 2009.

Both ZetaLux and enhanced EvoLux are available today from The EarthLED Store and Advanced Lumonics distribution partners.

The new ZetaLux and enhanced EvoLux join a fresh new lineup of EarthLED LED Lighting products for 2009 including:

TriSpectra 3 - The World's Most Powerful LED Based MR-16 Solution
DirectLED-HL - The First Direct LED Replacement for G4 Halogen Lamps
DirectLED-PL - The First Direct LED Replacement for PL Fluorescent Lamps
DesignoLux - LEDs Designed Specifically for Decorative Lighting
GrowLED - A Comprehensive Range of Affordable LED Grow Lights. ■

New Ocean Optics Light-Measurement Device

Jaz, from Ocean Optics, is a modular, handheld optical-sensing instrument now available for radiometric analysis of LEDs, flat panel displays, lamps and other radiant sources. With its small footprint and convenient

onboard display, Jaz is ideal for relative intensity measurements of incandescent, high-intensity discharge, UV curing and fluorescent lamps, as well as low-power sources such as LEDs and OLEDs.



Jaz provides full spectral analysis in a simple, handheld unit

Jaz is a family of stackable, modular and autonomous components that share common electronics and communications. Included in the Jaz stack is a CCD-array spectrometer that can be optimized for a variety of radiometric measurements and a microprocessor with onboard display. Unlike traditional light meters, Jaz allows users to capture, process and store full spectra without the need for a PC. Spectral data can be transferred to a laptop or desktop PC for additional post-acquisition processing, such as calculating colour temperature, spectral intensity and colour space values.

Jaz's Ethernet and battery modules offer unmatched portability. The Ethernet module has data storage capability via an SD card slot and allows users to connect to the Jaz unit via the Internet -- making remote measurements such as solar irradiance possible and enabling the creation of networked sensing modules. The Lithium-Ion battery module is rechargeable in the field via a solar cell or in the QC lab using the Power over Ethernet connection (100 Mbps, IEEE 802.3-compliant 10/100 single-cable), the USB 2.0 port or an external power supply. The battery module also has a power-conserving sleep mode for long-term measurements and two additional SD card slots for storing data.

"Jaz offers an attractive combination of spectral sensing power and handheld portability for all sorts of lighting measurements," says Mike Kayat, Ocean Optics Vice President of Sales & Marketing. "As energy savings and cost concerns help drive demand for more efficient LEDs and other types of lighting, the value of simple, convenient diagnostic instrumentation is magnified."

The Jaz platform also expands to include light sources (VIS-NIR or LED) and additional spectrometer channels. Jaz can be connected to fibre optic sampling accessories such as integrating spheres (for collecting emission with a 360-degree Field of View), cosine correctors (collecting with 180-degree Field of View) and optical fibres. An add-on holster accessory makes the Jaz wearable, freeing hands to manipulate sampling devices. ■

Research News

DOE Released New LED Reports

DoE recently released two reports on "LED Area Lights" and "Residential LED Lighting", as well as two new CALiPER Benchmark Reports. While the "Benchmark Reports" showed relatively poor results for the LED replacement lamps, the tested products for residential and for commercial lighting showed convincing results.

Commercial Garage LED Lighting Demonstration:

These results indicate very similar minimum light levels produced by Version 1 of the LED luminaires and HPS, and possibly slightly higher minimum light levels with Version 2 of the LED luminaires. All results were above the IES recommended level of 1 fc. More than half felt the LED luminaires provided more light than the HPS sources and a majority expressed a preference for the new fixtures when viewing the relamped area through a security camera. PNNL also calculated simple payback and found that Version 1 showed paybacks of 6.5 yrs at \$0.065/kWh and 4.1 yrs at \$0.11/kWh while Version 2 showed paybacks of 6.3 yrs at \$0.065/kWh and 3.9 yrs at \$0.11/kWh.

Residential LED Lighting Demonstration:

The LED downlight product drew 12W of power, reducing energy use by 82% compared to a 65W incandescent reflector lamp and by 84% compared to a 75W halogen reflector lamp. The LED undercabinet fixture drew 10 watts, cutting energy use by 83% to 90% compared to a halogen product, which was tested at two power settings – a low power setting that drew 60 watts and a high power setting that drew 105 watts. Paybacks on the LED downlights ranged from 7.6 years (assuming electricity cost of 11 c/kWh) to 13.5 years (at 5c/kWh) based on product costs of \$95 per LED downlight and three hours of usage per day. Paybacks on the LED undercabinet fixture in a new home ranged from 4.4 years (11c/kWh electricity) to 7.6 years (5c/kWh) based on product costs of \$140 per LED undercabinet fixture at two hours of usage per day.

Performance of Incandescent Lamps and LED Replacements:

Most manufacturers claim much too high values for their products. Very often the LED lamps that replace incandescent lamps produce only 10–60% of their claimed light output, while carrying claims such as "equivalent to a 25W lamp" or "replaces a 40W lamp" or "90% more efficient than a 60W lamp."

Performance of Halogen MR16 Lamps and LED Replacements:

MR16 LED replacement lamps were compared to 20W halogen lamps. Broad variations were observed in tested performance. Even the best performing LED replacement lamp doesn't reach the light output of the least efficient halogen lamp. DoE stated that in cases where lower light levels are desirable, LED MR16 lamps may provide a more efficacious alternative to halogen lamps. ■

Cree Achieves 161lm/W from a High-Power LED

Cree, Inc. (Nasdaq: CREE), a leader in LED lighting, announces it has achieved industry-best reported R&D results of 161 lumens per watt for a white power LED.

These results demonstrate Cree's continued commitment to deliver industry-leading performance through a constant focus on innovation and R&D. Cree's tests confirmed that the 1mm x 1mm LED produced 173 lumens of light output and achieved 161 lumens per watt efficacy at a color temperature of 4689K. The tests were conducted under standard LED test conditions at a drive current of 350mA, at room temperature.

"Cree is inventing, commercializing and delivering LED lighting innovations that aim to obsolete the energy-inefficient light bulb," said John Edmond, Cree co-founder and director of advanced optoelectronics. "Our advances in brightness and efficacy come from a focus on end-to-end innovation that can enable LED lighting to address growing numbers of lighting applications while saving energy, saving money and helping to protect the environment."

While this level of performance is not yet available in production LEDs, Cree continues to ship millions of 100+ lumen lighting-class XLamp® LEDs. ■

BASF and OSRAM Set New Standards for OLEDs

BASF and OSRAM Opto Semiconductors have developed a highly efficient white organic light-emitting diode (OLED): for the first time an OLED not only is able to achieve a light yield of over 60 lumens per watt (lm/W), but also, at the same time, meets the international Energy Star SSL Standard with regard to color requirements. Lighting efficiency on this scale had been achieved previously. Lighting efficiency describes the ratio of luminous flux given off by a lamp to the amount of power consumed; the greater the yield, the less energy is lost. However, up until now the color values of OLEDs have not been within the acceptable band for color coordinates around the Planck curve, as defined by the Energy Star SSL Standard. The color values of the new OLED are within this band – its light retains the white color at different levels of intensity.

By developing a white OLED with a high light yield, the two companies have completed a major step on the way towards commercial OLED lighting. In the development laboratories of Siemens Corporate Technology (OSRAM is part of the Industry sector of Siemens) highly efficient semiconductor materials from BASF Research were combined with standard materials – and thereby new standards set with regard to color coordinates and efficiency. BASF and OSRAM are conducting

research together within the framework of the "OLEDs for Applications on the Lighting Market" (OPAL) project. The OPAL project is being sponsored as part of the OLED Initiative of the German Federal Ministry for Education and Research (BMBF).



In the JIL, BASF OLED lab, it is the researchers' aim to develop OLED-based illuminants that consume only half as much electricity as conventional energy-saving lamps and have a longer life.

The new OLEDs contain phosphorescent metal complexes as emitter materials and customized complementary materials, which ensure optimum constancy of the color temperatures. That means that, owing to the use of new materials, the diodes are very color-stable even when there are variations in luminous intensity. The challenge now is to optimize the life of these OLED tiles, especially by stabilizing the blue emitters.

The Lighting Solution of the Future

However, OLEDs offer even more convincing advantages. Unlike conventional filament bulbs they do not become hot when emitting light and less energy is lost through radiated heat. The laboratory results show that the new OLEDs are five times as efficient as filament bulbs and up to 50 percent more efficient compared with standard low-energy lamps. OLEDs consume much less electricity than conventional sources of light, so consumers will in future be able to cut their electricity costs with OLEDs.

The experts at BASF are dealing with the material side of the OLEDs and, within the framework of the OPAL project, are developing the optimum component structures in partnership with Philips and OSRAM. BASF reached an important milestone in OLED research a few years ago. White light from OLEDs can best be obtained by combining red, green and blue light. For a long time there was no efficient source for deep-blue light. In 2003 BASF researchers laid the foundation for a phosphorescent blue emitter by developing a new class of materials based on an iridium complex. "Our aim is to develop stable blue phosphorescence emitters. Whilst the color coordinates and efficiencies of the new blue OLEDs are already outstanding, the service life still presents many challenges," explains Dr. Elmar KeBenich, OLED project manager at BASF Future Business GmbH. "If we manage to produce deep-blue stable emitters, that will open up the way for us to make white OLED light tiles with a light yield of more than 100 lm/W."

In future, organic light-emitting diodes will be suitable for general lighting as flat sources of light – for offices or as decorative lighting in stores. And they not only offer the potential of being considerably more economical than conventional low-energy bulbs in terms of electricity consumption, but are also capable of being used in a variety of ways as flat, transparent and, in future also, flexible sources of light. They will provide completely new opportunities in terms of design and performance – in part owing to newly developed semiconductor materials from BASF. "The challenge now lies with the process engineers to apply these high efficiencies economically to large active areas," says Dr. Karsten Heuser, OPAL Coordinator and Director OLED Lighting Technology at OSRAM Opto Semiconductors. ■

IP News

Sharp and Nichia Enter into LED and Laser Diode Patent Cross-Licensing Agreement

Sharp Corporation and Nichia Corporation have entered into a patent cross-licensing agreement covering LEDs and laser diodes.

This cross-licensing agreement grants each other the right to use inventions related to LEDs and laser diodes covered by the vast number of patents owned by the respective companies in Japan and in major countries.

LEDs feature long service life and low power consumption, and are increasingly expected to be the strongest candidate for the next generation of lighting devices. At present, LEDs have been adopted mainly for use in backlights for mobile phones and PDAs, but in the future, they are expected to gain acceptance not only for general illumination applications, but also for use in large numbers in the backlights of LCD TVs and for automotive lighting.

At the same time, laser diodes have long been the key device used in recording and playback of optical disks such as CDs and DVDs. Today, as HDTV images become increasingly familiar, demand is growing rapidly for blue-violet laser diodes as indispensable devices in recording and playback of terrestrial digital broadcasts, and for Blu-ray Disc recorders and players.

Sharp launched the development of LEDs in 1968 and began mass production in 1970. In addition, Sharp was the first in the world to begin mass production of infrared laser diodes for CDs in 1982, and in February of this year, initiated mass production of 250-mW, pulsed-output, high-power blue-violet laser diodes – one of the highest levels in the industry.

And now, by working toward the development of a vertically integrated business model based on these two devices, including LED lighting and Blu-ray Disc recorders, Sharp is aiming to create unique, one-of-a-kind products in the future that feature both devices at their core.

By entering into this cross-licensing agreement, Sharp and Nichia will be aiming to create even higher-performance LEDs and laser diodes, enabling the two companies to respond to rapidly expanding market demand. ■

SSC and TOE sign Cross License Agreement

Seoul enters into a cross license agreement with TOE Europe and its patent partners. Based on this agreement, Seoul enhances its flexibility in manufacturing LEDs.

Seoul Semiconductor Co., Ltd. ("SSC") today announced that SSC has entered into a cross license agreement regarding white LEDs using silicate system phosphors with TridonicAtco Optoelectronics GmbH ("TOE") and its patent partners.

Phosphors are indispensable materials to manufacture white LEDs. Especially, white LEDs incorporating silicate system phosphors are covered by a wide variety of patents and are significantly different from conventional LEDs using other phosphors.

Under the Cross License Agreement, SSC is in a very strong position to manufacture and sell its own white LEDs using silicate system phosphors as well as expand and accelerate relevant R&D activities.

Based on this agreement, SSC's white LEDs using silicate system phosphors can be covered by its patents and such license. ■

Correction

Optics

Optical Research Association points out, that in "**Microstructured Optics for LED Applications**" of the September/October 2008 issue, page 24, of *LED professional Review*, Mr. Davis mischaracterizes the optimization capabilities of the recent LightTools version when he writes that, "ASAP has a linear optimizer..., TracePro and LightTools have none."

In fact, LightTools does provide a fully integrated optimizer with 3D solid modeling features and algorithms especially developed to solve illumination design problems. The LightTools optimizer has been available to all users since 2005, when it was introduced in Version 5.2, and has been continuously upgraded and improved. ■

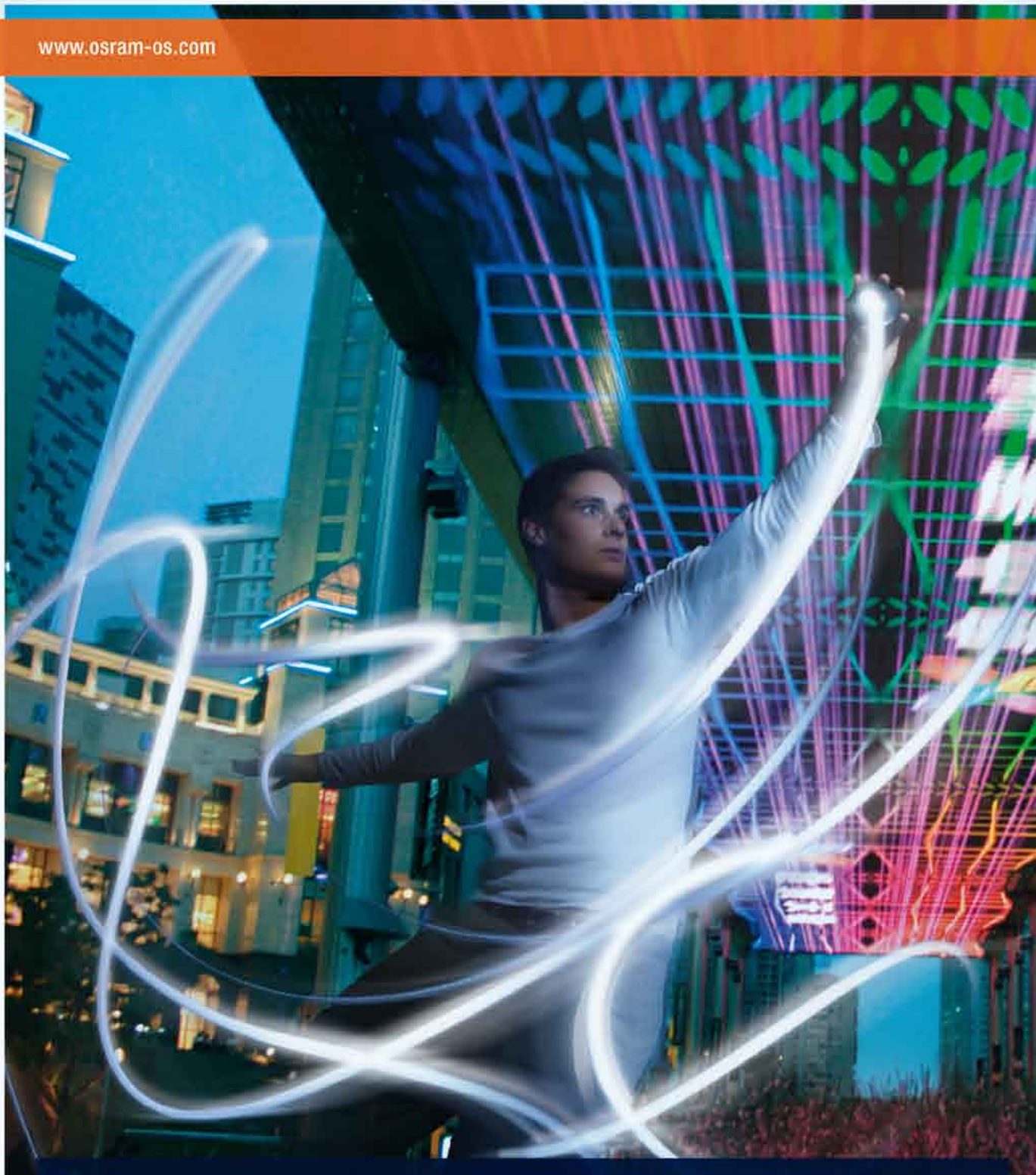

LEDs for General Lighting Solutions

OSRAM Opto Semiconductors empowers lighting solutions of today and tomorrow

Opto Semiconductors

OSRAM

Characterization

LED Lighting Technology Fundamentals and Measurement Guidelines

> M. Nisa Khan, Ph.D., President, LED Lighting Technologies

Advances in solid state lighting has been remarkable considering how fast their efficiency, light output and quality have improved in the past few years. Today the illumination and display industries have many diverse applications that are gaining acceptance because LEDs offer important energy savings; in addition, their flexible form factors, scaling, and attractive color combination capabilities offer many architectural and decorative lighting designs for residential and commercial buildings – both indoors and outdoors.

While these SSL capabilities are unique and promising, the industry nevertheless is at an early stage and many fundamental technology understandings still need to become more ubiquitous. Here I shall attempt to lay some groundwork on SSL efficacy limits, efficacy and CRI tradeoffs, and technologies for increasing efficacy, illuminance (the amount of light confined on a surface of a particular size), and product yield; In addition, I shall attempt to establish some photometric measurements and guidelines that could leap the LED lighting industry onward.

Efficacy and Efficiency

Luminous efficacy is a conventional measure of how efficient an electrical lighting element is. It is a measure of how much luminous flux is produced per unit of electrical input power and therefore is measured in 'lumen/watt' (lm/W). In contrast, luminous efficiency is given in percentages where both power units must be either in lumens or watts, depending on what efficiency one is interested in determining. If both power units are in watts, we get a complete idea of what percentage of electrical energy we have been able to convert to optical energy at one instant of time. This is very useful as the world now is more conscious about energy efficiency. However, when we need a certain amount of visible light for certain applications, it is helpful to know how many lumens are being generated per unit of electrical power, which then easily leads to how many total lumens we can get out of certain electrical wattage that goes into the lighting system. This is where efficacy is useful. But when we ask, for example, how much light is still available to us when a lamp is placed in a fixture where some light is being hindered by the fixture, we need to determine the luminaire efficiency which would then be defined by a ratio of two powers in lumens.

These concepts are important for all lighting in general. For SSL, the industry focus has been largely on increasing efficacy, which is only a part of what our concentration needs to be. Further, a basic understanding of overall end-end system efficiency can help determine theoretical and practical efficacy limits – very important boundaries of which we need to be mindful.

In order to determine the theoretical limit for efficacy for any lighting unit, one must first ask how lumens relate to watts, i.e., what is the watt equivalent of a lumen. One lumen (lm) is the equivalent of 1.46 milliwatt (mW) of radiant electromagnetic (EM) power at a frequency of 540 terahertz, or 5.40×10^{14} Hz, which corresponds to the middle of the visible light spectrum at around 555 nanometers (nm). An EM field power level of 1.46mW is rather small; for example, the radio-frequency (RF) output of a children's toy two-way radio is several times that amount.

Since, 1 lm = 1.46 mW, then 1 W = 685 lm at 555 nm.

Therefore highest efficacy theoretically attainable (i.e., 100% efficiency) is 685 lumens per watt – the output that would be obtained if all the input power were converted to green light at a 555 nm wavelength, the light wavelength to which the human eye is most sensitive. The maximum theoretical efficacy of any light source producing white light with its entire output power distributed uniformly with respect to wavelength within the visible region is only 200 lumens per watt. Thus, by concentrating the output wavelength of any light source near the 555 nm point, we can improve the efficacy beyond that possible with 'perfect' white light consisting all visible wavelengths with equal amount of power in each wavelength. The efficacy of average present-day fluorescent lamps is about 60 to 70 lumens per watt, although some high-end ones have higher efficacies.

Here are some examples of efficiency levels of various light sources:

Example 1: a typical incandescent light with 15 lm/W efficacy is about 2% efficient; 98% of input power goes to heat.

Example 2: an LED or CFL with 100 lm/W efficacy is about 14% efficient; 86% of input power still goes to heat.

In an incandescent lamp, typically 98% of input electrical power converts into radiant heat, whereas in a green LED with 70 lm/W for example, almost 90% converts into conductive heat, which must be removed from the LED chip for optimal performance.

Earlier we discussed that if we create a white light source where the input electrical power is uniformly distributed over all wavelengths in the visible spectrum, we would achieve the maximum theoretical efficacy of 200 lm/W; this is a white light source with perfect color rendering index (CRI)! It then follows that if we attempt to increase this theoretical efficacy from 200 lm/W by concentrating more light output power near the green region, the CRI would decrease. Thus, there is an inherent trade-off between efficacy and CRI for white light sources.

Figure1 is the CIE 1931 chromaticity diagram showing all the colors perceivable by the normal human eye; the point of equal energy line is shown near the center of the diagram.

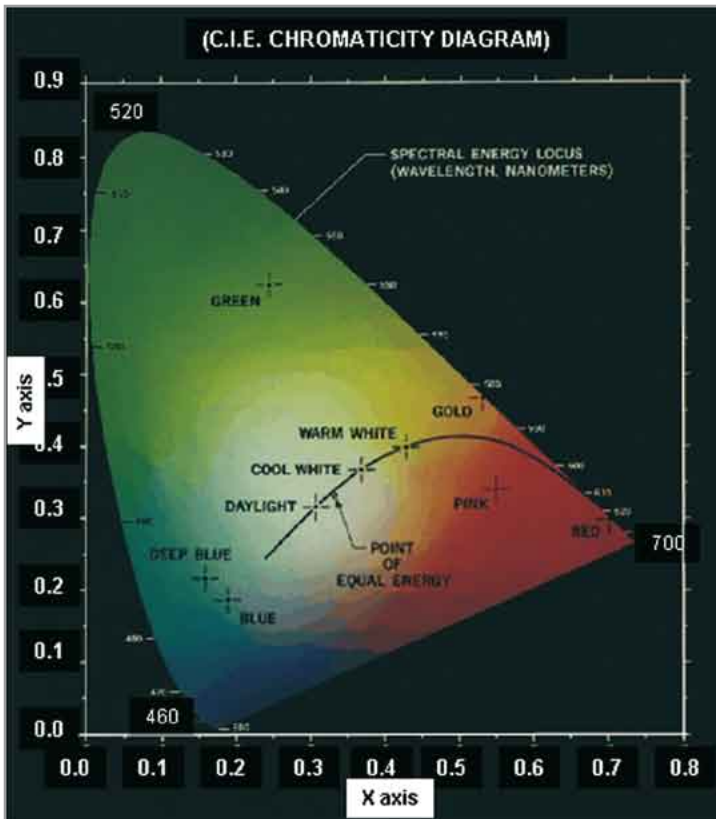

Figure 1: The CIE-1931 Chromaticity Diagram

LED Luminaire Efficacy

For conventional light sources, the lighting industry generally speaks of lamp efficacy and luminaire efficiency, because the lamp is detachable from the luminaire fixture. However in the case of LEDs, this is not always the case. When the LED light source is fully integrated with its luminaire, the efficacy must be that of the entire LED luminaire system and luminaire efficiency, known as

$$\text{luminaire efficiency (\%)} = \frac{\text{luminaire output (lm)}}{\text{lamp output (lm)}} \times 100 \quad \text{Eq. (1)}$$

no longer has any meaning. The LED luminaire efficacy depends on several types of efficiency factors; the product of all such factors yields the total SSL efficiency, η_T , from which one can estimate the LED luminaire efficacy. As such,

$$\eta_T = \eta_{\text{int}} \times \eta_{\text{ext}} \times \eta_{\text{dr}} \quad \text{Eq. (2)}$$

where η_{int} , η_{ext} , and η_{dr} are LED internal quantum efficiency, light extraction efficiency, and the driver efficiency respectively.

Let us now see how one can arrive at some credible practical limit of a white LED luminaire, assuming that the present-day core technologies can still be further enhanced.

Most white LEDs currently use blue LEDs combined with yellow or other-color phosphors. High power blue LEDs use either InGaN or AlInGaN as the active material.

The quaternary compound, AlInGaN has η_{int} of 50%. This internal quantum efficiency, which is the efficiency at which light is generated in the semiconductor via electroluminescence, is further reduced if the region where the electrical current passes through is not optimally overlapped with the active material region. This depends on LED device geometry, which in most current LED designs does not likely exceed 55%.

The amount of light coming out of the LED module is limited by η_{ext} , which depends on internal reflection and absorption by various surfaces and materials in the system including phosphor. Appropriate index matching and high-quality phosphor and semiconductor materials will improve the overlap integral of optical power transfer from the chip-encapsulation ensemble to the external region.

Finally, the efficiency of the driver, η_{dr} , which delivers the injected current into the semiconductor diode, limits the overall η_T .

At present, some of the best R&D white LEDs have been demonstrated with efficacies of about 125 lm/W. This is likely achieved with the following efficiencies from the factors described above:

$$\eta_T = \eta_{\text{int}} \times \eta_{\text{ext}} \times \eta_{\text{dr}} = (\text{AlGaInN:0.5})(\text{device geometry: 0.55})(\text{light extraction:0.7})(\text{driver:0.95}) = 0.182 \rightarrow 18.2\% \text{ efficient} \rightarrow 125 \text{ lm/W}$$

Several design enhancements and strong engineering optimizations on the overlap integrals may lead to the following scenario:

$$\eta_T = \eta_{\text{int}} \times \eta_{\text{ext}} \times \eta_{\text{dr}} = (\text{AlGaInN:0.5})(\text{device geometry: 0.9})(\text{light extraction:0.8})(\text{driver:0.95}) = 0.342 \rightarrow 34.2\% \text{ efficient} \rightarrow 234 \text{ lm/W}$$

The assumption made here is that lumen equivalency of one watt is taken from the green wavelength region, which is a good approximation when blue LEDs are used with yellow phosphors to generate white light. This exercise shows that we can expect the practical efficacy limit of white LEDs to be around 234 lm/W.

LED Performance and Yield Improvements

LED lighting efficacy, brightness, color quality and stability depend on many issues and the interdependency of these issues are quite complex. These depend on chip design, material quality, fabrication accuracy, robustness of packaging technologies, as well as the comprehensive mechanical, thermal, and optical design and engineering. Among these are material morphology and uniformity factors that largely contribute to the well-known compound semiconductor yield problem. High quality epitaxial growth of compound semiconductors on suitable substrates will help increase the product yield substantially. In order to make LED lights stable, manufacturers must perform firm burn-in, reliability, and accelerated aging tests at sufficiently high temperatures. Many of these technologies can be drawn from the vast work already done by the telecommunication lasers and LEDs, which are documented in numerous Telcordia (formerly Bellcore) requirements.

Even when white LEDs will operate at much higher efficacies than today, there will still be a significant amount of heat that must be removed from the chip because of the practical efficacy limit I discussed earlier.

This will require very effective thermal management in the module that must be achieved via elements with suitable thermal conduction properties and mechanical design for optimum heat flow. Development and implementation of these technologies will ensure very long lifetimes and will also provide more uniform products; this will substantially reduce binning requirements for LED luminaires that greatly concern the customers today.

Photometric Measurements and Guidelines

The SSL industry has made notable progress in establishing photometric measurements and guidelines in the past few years. The recent updates and releases of IESNA LM-79, LM-80 and ANSI/NEMA/ANSI C78.377 standards are a testament to such. The United States DOE also recently published a preliminary document, "Manufacturer's Guide for Qualifying Solid-State Lighting Luminaires," that outlines performance benchmarks for its 'Energy Star' criteria. The document lists DOE's certified facilities that conduct Energy Star qualification testing and details approval procedures.

LEDs have numerous applications in the lighting and display industries and therefore, many more standards and guidelines will need to be adopted in the near future. Since lighting and display products each provide distinctly different functions, primary purpose of the light sources need to be distinguished. A lighting unit needs to have certain amount of brightness, light distribution, and color properties because we need it to provide illumination in certain areas of interest so that we can effectively view other objects. In contrast, a display unit needs to have certain amount of brightness and color properties so that we can effectively view information on it, but it does not need to provide us illumination to view other objects.

Today we often see LED manufacturers and retailers tout 'super bright' LEDs for many types of luminaires. This is not always desirable from the user's standpoint because they will not stare at the luminaires, but will require that it provides light where they want them; users need enough light for specific applications, but do not appreciate too much light that can produce glare and discomfort and wastes energy. Therefore a luminaire must be bright enough as well as have proper optical radiation properties to illuminate areas of interest.

In order to design a luminaire, one must then design it for a certain level of brightness – the quantity known as luminance. Luminance is usually measured in nits, which is candela/square meter (cd/m²). A luminaire must be able to radiate certain amount of light to illuminate certain surface. An LED luminaire designer ultimately needs to measure the illuminance (the amount of light incident or confined on a surface) in lux or footcandles to ensure the desired amount of light hitting on a surface; lux is measured in lumen/square-meter (lm/m²).

To simplify things and considering only normal incidence, luminance and illuminance are related as the following: (Reference: IESNA TM-11-00)

$$E_v = \frac{L \times S}{D^2} \quad \text{Eq. (3)}$$

Where E_v is the illuminance, L is the luminance of the luminaire, S is the surface area of the luminaire, and D is the normal distance from the center of the luminaire to the center of the illuminated surface. This is the well-known inverse square relation that Swiss German physicist Johann Lambert (1728 – 1777) helped formulate in the 18th century.

Since many luminaire and lighting designers use 'feet' rather than 'meters' for spatial parameters, this equation is often written as:

$$E_v = \frac{L \times S}{10.76D^2} \quad \text{Eq. (4)}$$

In this equation, the measurement units are the following:

- L is in nits
- S is in square-feet
- D is in feet, and
- E_v is in footcandles.

Using this functional relationship, the following section exemplifies the importance of a new luminaire design that is more energy efficient and provides more light where the user needs it compared to the more popular designs seen today.

Example of an LED luminaire application – under cabinet lighting

Here I contrast two designs for an LED under cabinet luminaire that will demonstrate how to interplay brightness and size to achieve the desired illuminance at the counter top surface using less energy to produce more uniform illumination.

In Design A (Figure 2), the LED luminaire surface area is approximately 4.8 a.u. where a.u. is the arbitrary unit of square area. There are 40 discrete LEDs within this surface area. In Design B (Figure 3), the LED luminaire surface area is approximately 3.0 a.u. and there are 18 LEDs within this surface area.

Since the distance D is the same in both cases, in order to produce the same illuminance at the counter top (assuming only normal angle incidence), the following yields:

$$E_{vA} = \frac{L_A \times S_A}{D^2} = E_{vB} = \frac{L_B \times S_B}{D^2} \quad \text{Eq.(5)}$$

which follows that

$$L_A \times S_A = L_B \times S_B \text{ and hence } L_B = L_A \times \frac{S_A}{S_B} ;$$

Since $S_A = 4.8$ a.u. and $S_B = 3.0$ a.u., $L_B = L_A (1.6)$, meaning that the luminance in the Luminaire B group (3 luminaires) must be 60% more than that of the single Luminaire A. This implies that 18 LEDs in the Luminaire B group need to produce 60% more brightness to equal the brightness from 40 LEDs in Luminaire A. This means that the LEDs in Luminaire B need to have more than twice the brightness than the LEDs in Luminaire A.

The uniformity of light distribution in Design A is also much better and the LEDs will run more efficiently for a longer period of time compared to those in Design B.

The reader should note that the calculations in this example ignore the cosine dependence of illuminance as well as the full integration over the counter surface in order to make simple arguments; nevertheless, comparisons in the designs provide sufficient validity on an "average" basis.

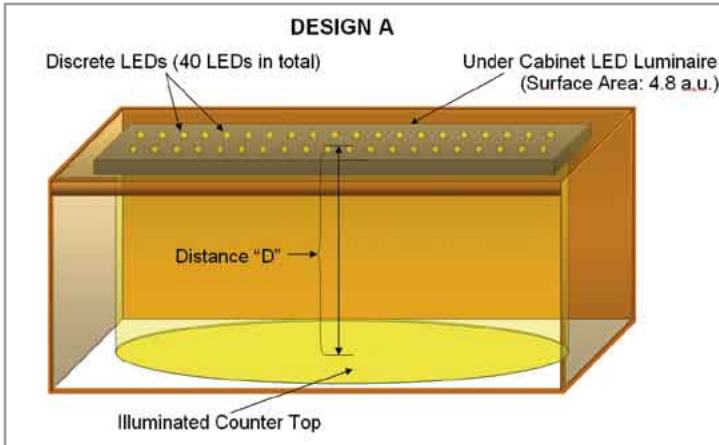

Figure 2: Design A Schematic showing a single luminaire of 4.8 a.u. surface area containing 40 LEDs

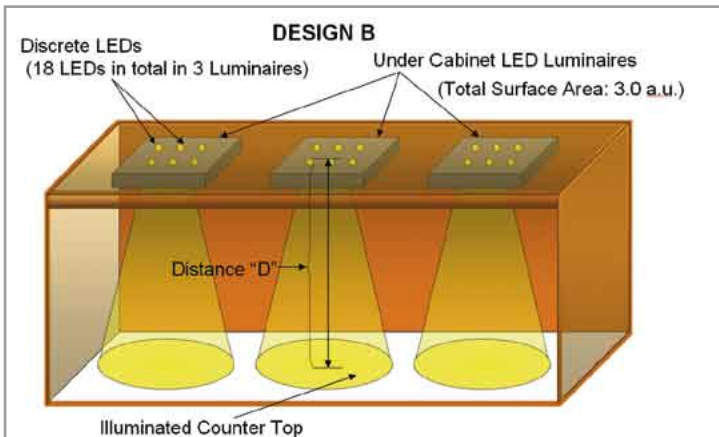

Figure 3: Design B Schematic showing 3 luminaires of 3.0 a.u. surface area containing 18 LEDs

There are many LED under-cabinet luminaires being offered by many retailers. Only a few resemble Design A, such as this one from Global Green Lighting shown in Figure 4.



Figure 4: Under cabinet light from Global Green Lighting retailer

However, most under cabinet luminaires available in retail today are discrete luminaires such as the ones in Design B; these typical under cabinet discrete luminaires of today as seen in the Figure 5 below is less effective in illuminating the counter top and they require excessive brightness to produce acceptable counter top illumination.



Figure 5: Typical under cabinet lights from most retailers of today

Conclusion

In this paper, I have presented some fundamental basics on SSL efficacy limits and discussed the essential efficiency factors that comprise the efficacy of an LED luminaire. I have also emphasized the such key constituents for SSL development as efficacy and CRI tradeoffs, and technologies for increasing efficacy, illuminance (light output), and product yield; in addition, I have provided a real-life example of an under cabinet luminaire design to demonstrate the importance of interplaying size and brightness of a luminaire to provide more light where the user needs it while being significantly more energy efficient. This groundwork is intended to help the current industry further establish relevant sets of photometric measurements and guidelines that could accelerate the advancement of the LED lighting industry. ■

CIE 1964 Colorimetric Observer Chart Improves White Light Quality

> Peter Pachlar, Tridonic Atco Optoelectronics

The most popular concept of phosphor-converted white LEDs relies on a mixture of blue LED light (a fraction of which is exciting green, yellow or red phosphors) and the phosphor emission to generate a broad white light spectrum. With the advent of a new generation of high brightness LEDs especially in the blue spectral range this white light technology gains maturity for a successful market penetration within the next years [1-4]. None the less, there are still major challenges ahead which on the one hand are originating from the specific demands of the markets and on the other hand from the perception of the white light quality. To quantify the latter the spectral properties of the LED emission are reduced to chromaticity coordinates that are derived from the colour sensitivity of the human eye. Generally, the industrial approach on LED chromaticity is based on the CIE 1931 standard observer chart albeit latter is known to pose the problem of an incorrect blue color matching function (CMF) in combination with the narrow band emission of the blue LED light [5]. Moreover, for some of the primary LED applications like the lighting of a white wall or the backlighting of signs and boards the alternative CIE 1964 supplementary standard colorimetric observer chart provides better results with regard to color perception of the LED light than the CIE 1931 standard does. This behavior is not that striking since the two charts diverge in the evaluation of visual perception and the CIE 1964 chart has been recommended [6] and proven [7] to be superior for visual color matching of fields having angular subtense of more than 4° at the eye of the observer.

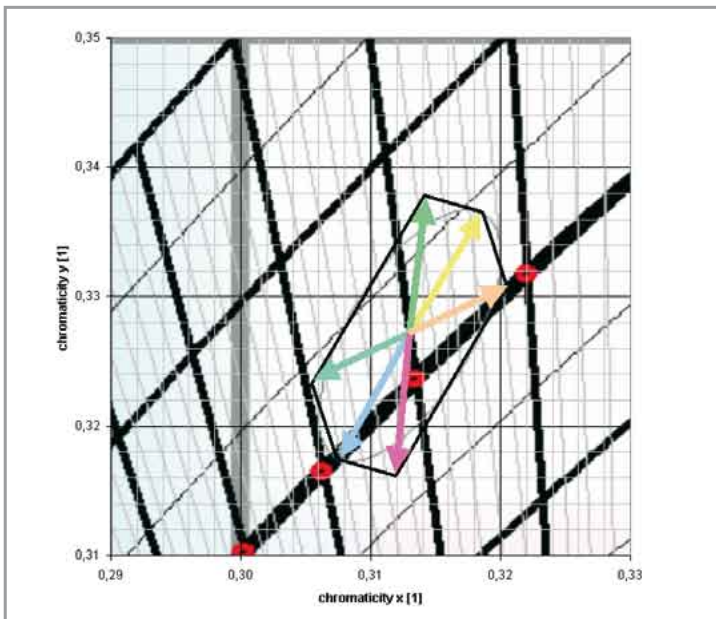

Figure 1: Standard tolerance window for TALEXX white LEDs having a correlated color temperature of 6500 K within the CIE1931 chart. The grey ellipse plotted in this image corresponds to a MacAdam step 5 ellipse

The black hexagon in Figure 1 depicts the tolerance window for TALEXX white LEDs having a correlated color temperature (CCT) of 6500 K within the CIE 1931 chart. The yellow – blue line indicates the actual spread of fabrication of individual LEDs (from a specific blue LED bin). For white LEDs matching the extremal points of this line an observer perceives some yellowish – bluish differences of the hue pertaining to side by side application of suchlike LEDs for the illumination of larger areas (e.g. a white wall) or backlighting of signs and boards. On the other hand, this conspicuity is much more pronounced along the other directions indicated within the tolerance window. For the green – pink line (the spread of fabrication typically matches about ¼ of the height of this distance) the intersections correspond to a MacAdam ellipse of step 6.6 while the intersections of the cyan – amber line roughly correspond to a MacAdam step 5 ellipse.

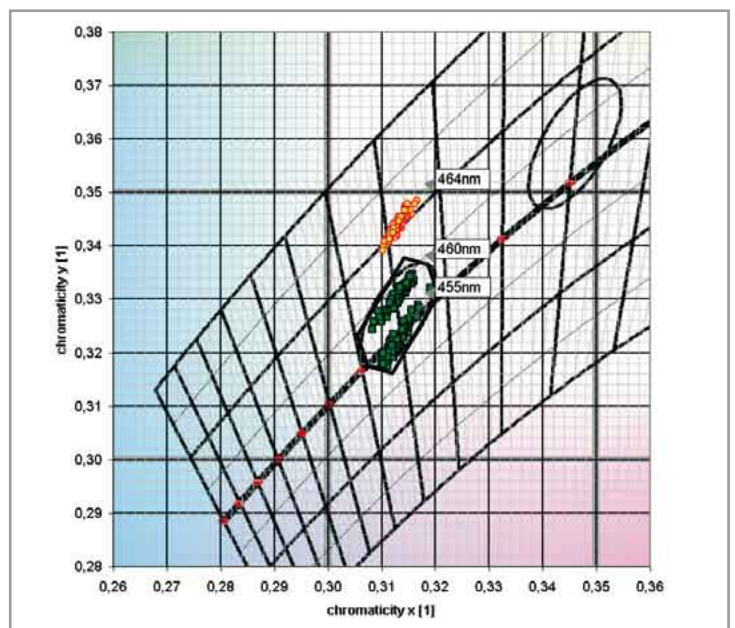
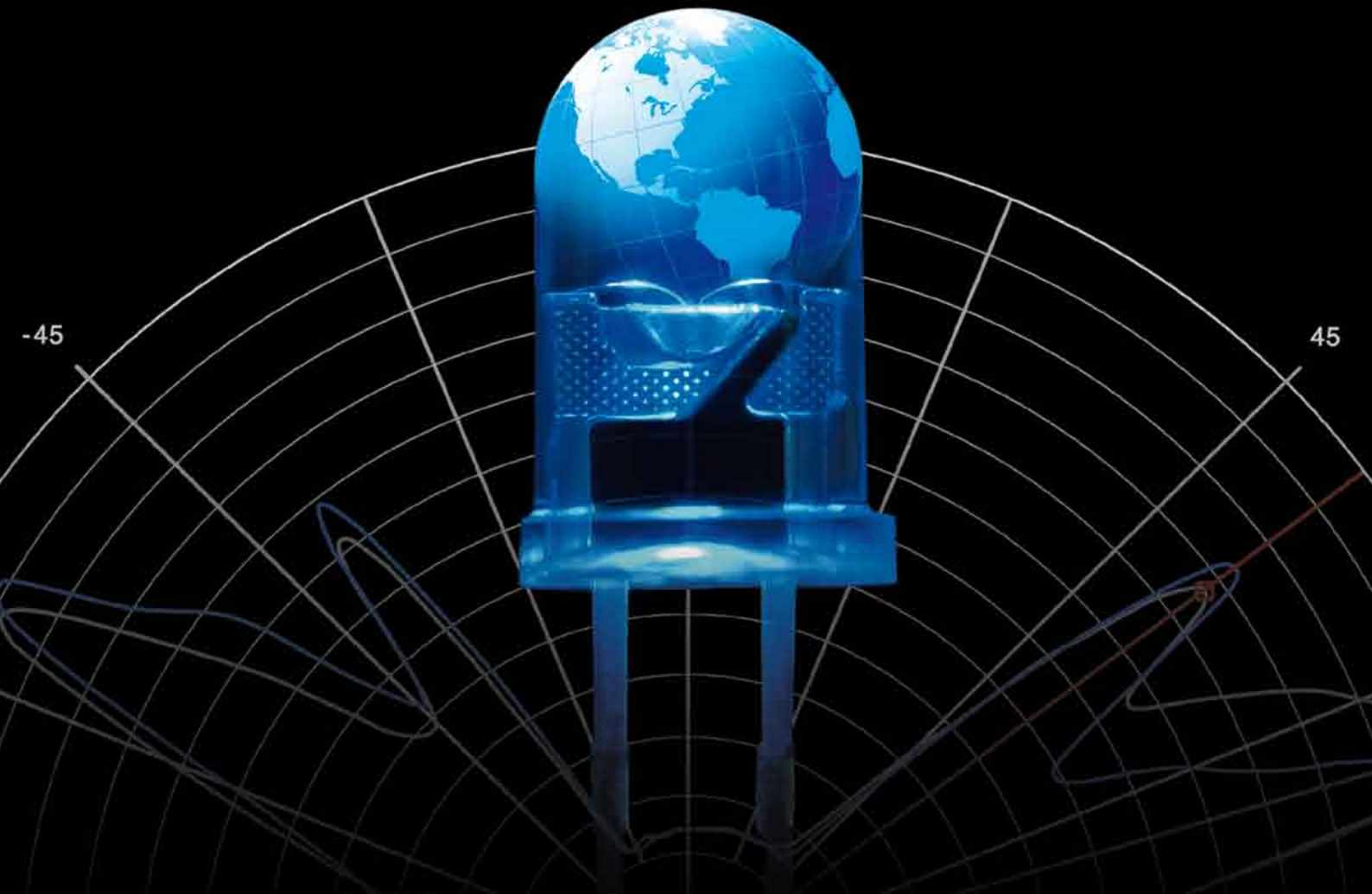

Figure 2: Impact of the variation of the mean blue dominant wavelength (for LED bins of 455, 460 and 464 nm) on the CIE x,y coordinates for the same amount and composition of colour conversion material

Figure 2 shows the impact of a variation of the mean blue dominant wavelength (for three different LED bins) on the CIE x,y coordinates together with the spread of fabrication. As shown in this figure, using only one type of colour conversion material for the individual LED bins of different mean dominant blue wavelengths results in diverse CIE chromaticity coordinates of the respective white LEDs, both for the x as well as the y coordinates. The standard process of TridonicAtco accounts for variation in wavelength of the blue LED bin by adjusting the amount and concentration of the colour conversion material. A combination of yellow and green phosphors and the adjustment of their fractions in dependence of the dominant wavelength allows one to counteract for the variation of the ycoordinates, while the variation of the x-coordinates can be easily counteracted by the overall phosphor concentration or the amount of colour conversion material. However, taking the CIE 1931 chart as a reference system for color matching may pose some problems regarding reality, especially for applications like the side by side illumination of larger objects.

We bring quality to light.



LED test & measurement solutions from the world leader

Instrument Systems continues to set the benchmark in LED metrology. Whether testing individual LEDs (standard or high-power), LED modules, or OLEDs - the global LED industry relies on us to engineer superior measurement equipment for high-speed production testing and high-performance R&D and QC applications.



Our instruments provide accurate and reliable results as per CIE recommendations and methods:

- Luminous flux [lm], luminous intensity [cd], and luminance [cd/m²]
- Chromaticity coordinates x,y,z and u'v'
- Color temperature and color rendering index
- Dominant wavelength and spectral data
- Spatial radiation pattern

 **Instrument
Systems**
light measurement

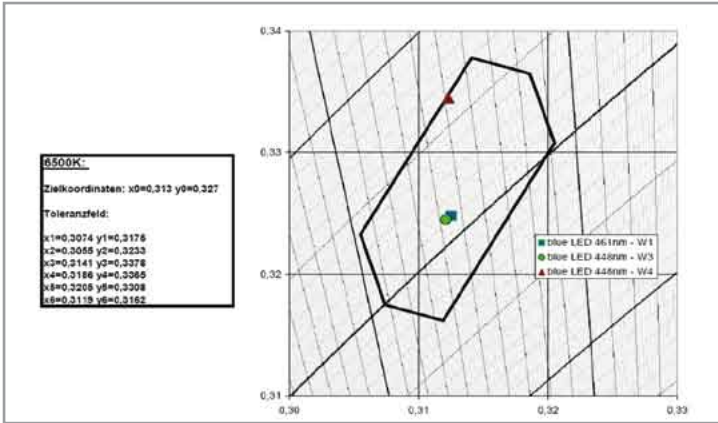

Figure 3: CIE 1931 x,y chromaticity coordinates for three LEDs that partially were fabricated from different bins of mean dominant blue wavelengths (461 nm and 448 nm)

Figure 3 shows the CIE 1931 x,y chromaticity coordinates of three white LEDs that partially were fabricated from different bins of mean dominant blue wavelengths (LED W1: 461 nm, LEDs W3 and W4: 448 nm). The corresponding emission spectra of the three white LEDs W1, W3 and W4 are depicted in Figure 4. Albeit the chromaticity coordinates of the LEDs W1 and W4 show a high diversity, especially with respect to the y coordinate, they were found to reveal similar subjective color perception by a number of test persons when these LEDs are mounted adjacent to each other and used for backlighting of signs or to illuminate white walls or milk glasses. As evident from a comparison of the LEDs W1 and W2, the lower the dominant wavelength of the blue LED bin the higher must be the value of the y coordinate in the CIE 1931 chart in order to achieve agreeing color perception for an observer.

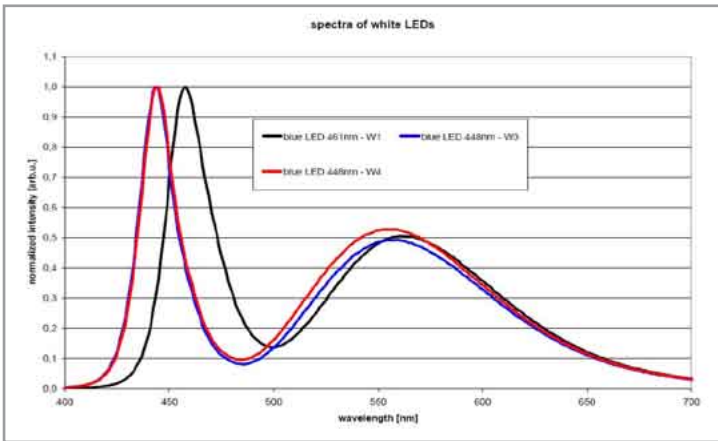

Figure 4: Emission spectra of the LEDs W1, W3 and W4 (see Figure 3)

On the other hand if the amount of color conversion material applied to the LEDs of different dominant blue wavelength bins was adjusted in order to achieve the same CIE 1931 x,y coordinates (LEDs W1 and W3), the subjective color perception was found to be different. If one opposes the white LEDs W1 and W3, which have the same CIE 1931 chromaticity

coordinates and which were fabricated from blue LEDs having dominant wavelengths of 461 nm and 448 nm, respectively, the hue of the LED pumped at 448 nm appears to be reddish in comparison to that of the LED pumped at 461 nm. Successively increasing the value of the y coordinate for the 448 nm LED reduces this difference till for a specific y value both LEDs have the same color perception (see Figure 3). Further increasing the y value of LED to even higher values reverses the perception for an observer: the 448 nm LED becomes comparably greenish while the initially comparable greenish 461 nm LED becomes comparably reddish. This means that with respect to the real world observation the calculation of the chromaticity coordinates according to the CIE 1931 chart reveals a totally contrary result: the chromaticity coordinates of the LEDs W1 and W4, which have an agreeing colour perception for an observer, show a strong deviation from each other. LEDs W1 and W3 have pretty the same x and y-chromaticity coordinates (see Figure 3), which means that a standard observer shouldn't be able to distinguish the color of the LEDs W1 and W3, a behaviour that is also in contrast to the experimental observation. On the other hand, Figure 5 depicts the corresponding chromaticity coordinates of the 3 LEDs within the CIE 1964 10° supplementary standard colorimetric observer chart. In total accordance with the experimental observation, in this chart the LEDs W1 and W4 have more or less congruent chromaticity coordinates, while especially the y- chromaticity coordinate for the LED W3 shows a significant deviation from that of the two other LEDs, which agrees with the noticeable deviation of the color perception of this LED by an observer.

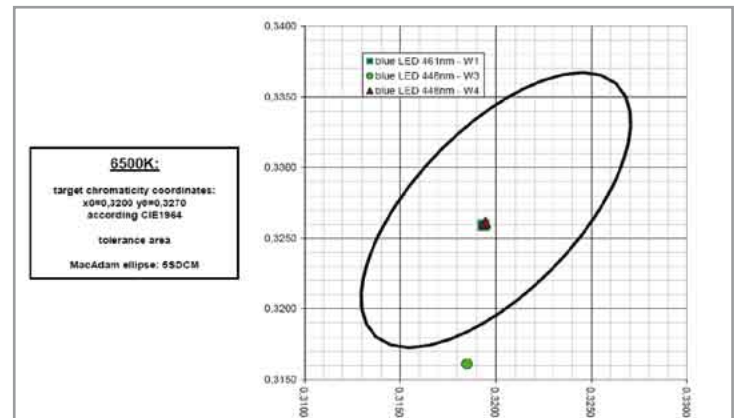

Figure 5: Chromaticity coordinates according to CIE 1964 chart for the three LEDs W1, W3 and W4

With regard to this, the CIE 1964 supplementary standard colorimetric observer chart turns out to be superior and more suitable than the CIE 1931 chart in order to evaluate the chromaticity of LEDs, in particular for illumination and signage applications. Therefore, the chromaticity assessment of TALEXX products will be further on handled on the basis of the large field CIE 1964 supplementary standard colorimetric observer chart in order to provide the costumers individual LEDs with best-in-class and reliable color matching and to guarantee LEDs that excel by the conformity of their visual perception. ■

References:

[1] E. F. Schubert and J. K. Kim, "Solid-state light sources getting smart" *Science* vol. 308, 1274 – 1278, (2005)
 [2] A. A. Bergh, "Blue laser diode (LD) and light emitting diode (LED) applications", *Phys. Stat. Solidi (a)* vol. 201, 2740 – 2754, (2004)
 [3] E. F. Schubert, J. K. Kim, H. Luo, J. Q. Xi, "Solid-state lighting – A benevolent technology", *Rep. Prog. Phys.* vol. 69, 3069 – 3099, (2006)

[4] M. R. Krames, O. B. Shchekin, R. Mueller-Mach, G. O. Mueller, L. Zhou, G. Harbers, M. G. Craford, "Status and Future of High-Power Light-emitting Diodes for Solid-State Lighting", *J. Display Technol.* vol. 3, 160 – 175, (2007)
 [5] Á. Borbély, J. Schanda, "Colour matching using LEDs as primaries", *Col. Res. & Appl.* 29, 360-364, (2004)
 [6] A. R. Robertson, "Colorimetry", *Rep. Prog. Phys.* 41, 469 – 510, (1978)
 [7] I. Nimeroff, "Field trial of the 1959 CIE supplementary standard observer proposal", *J. Opt. Soc. Am.* 54, 696 – 704, (1964)

SAMSUNG

ELECTRO-MECHANICS



We dream of a future full of bright colors. Through LED technology, this dream comes true. Samsung Electro-Mechanics provides a total solution with the world's best RF technology (Zigbee) and Power technology while managing the overall processes of LED Chip, Package, and Module technology. Samsung Electro-Mechanics leads the world of LED technology.

Middle Power



-5252 Warm & Cool White



-5252 R/G/B/A, RGB



-3228 Cool White



-3228 R/G/B/A, RGB

High Power



-1W Warm & Cool White, R/G/B



-2W Warm & Cool White



-3W Warm & Cool White

Side View



-0.4T/0.5T/0.6T

www.sem.samsung.com

- U . S . A - Steve Byun (sbyyun@samsung.com, +1-949-797-8054)
- Europe - Logan Yang (wjoon.yang@samsung.com, +49-6196-66-7240)
- A s i a - Hank Lee (hank.lee@samsung.com, +65-6833-3217)
S.C.Lim (schin.lim@samsung.com, +65-6833-3220)
- C h i n a - Tony Yoo (tony.yoo@samsung.com, +86-0755-8608-5550)

SAMSUNG
ELECTRO-MECHANICS



White Light LEDs – Importance of Accepted Measurement Standards

> Dr. Thomas Nägele, Instrument Systems GmbH

The breathtaking development of white light LEDs in recent years has led to significant market potential for a range of brand new applications. The high efficiency of these LEDs now means that solutions for room lighting, automotive headlights and backlighting for LCD displays can be realized. The advantages of their reduced energy requirements are apparent - for example, the running time of battery operated devices such as mobile phones and notebook computers can be extended considerably.

For general room lighting, the ability to vary the color temperature of a LED lamp allows new lighting designs. In automotive applications, the reduced energy requirement helps to reduce petrol consumption and CO₂ emissions. Moreover, their long lifetime minimizes service requirements for headlights - i.e. the LEDs will in all probability outlive the lifetime of the car itself. And lastly, the technical characteristics of LEDs also bring significant advantages for adaptable headlight technology when compared to conventional forms of lighting. All of these aspects additionally mean that these developments in automotive safety may also find application in a wider market.

Attaining and maintaining the necessary regulatory lighting standards still represents challenges for LED manufacturers, and much research is currently being made into methods to reduce and control the varying quality inherent in the production process. Indeed, the proper characterization of the light emission parameters forms an important aspect of the quality control process. However, this characterization, in particular for white light LEDs, is as a consequence of their optical properties somewhat complicated.

Optical Properties of White Light LEDs

The intercomparability of measurement results is influenced by a variety of factors. Both the fundamental technology underlying the structure of the LED itself and the measurement system used for characterization can play a decisive role. In order to ensure precise measurement of the LED emission, spectroradiometers have now become the preferred tool of choice over photometers and colorimeters. Spectroradiometers achieve better accuracy by obviating the need for optical filters and by making a computational calculation for the photometric and colorimetric parameters.

Inherent properties of the LEDs directly resulting from the manufacturing process also influence the measurement results. White light LEDs, usually comprising a blue emitting LED-chip coated with a yellow emitting phosphor, are particularly difficult to manufacture with consistent characteristics. Furthermore, well known factors such as burn-in time, operating temperature, aging behavior, etc., each make their own contribution to the emission performance of the LED.

Dependence on Temperature

Above all for modern high-power LEDs, proper thermal management and the operating temperature of the LED play a critical role in terms of reproducibility of operation. The energy density in such devices is considerably higher than that for conventional LEDs, resulting in the generation of significantly more heat. Continuous operation of high-power LEDs remains a major technical challenge, as varying temperature can be responsible for changes in the emission spectrum.

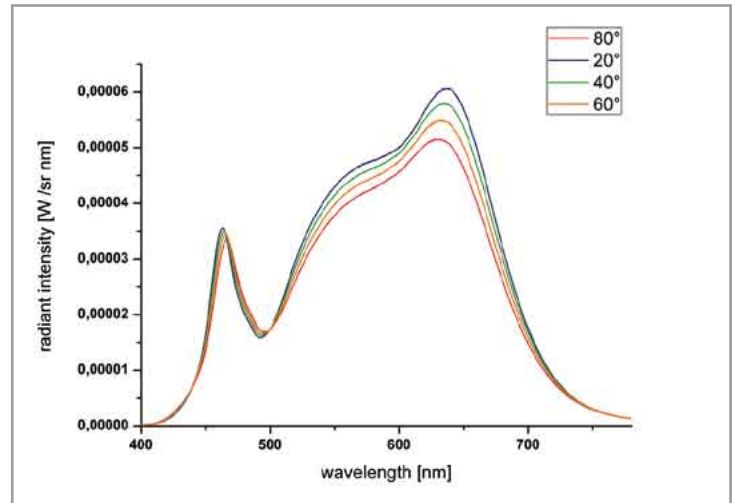

Figure 1: Dependence of the spectral emission of white light LEDs on temperature

Figure 1 illustrates the spectral dependence of an LED emitting warm white light over a temperature range from 20° to 80°C. Generally, in order to maintain a constant and uniform impression of brightness and color in continuous operation, the heat generated in high-power LEDs must be effectively dissipated. For characterization purposes, however, unambiguous indication of the thermal behavior of an LED is best gained through active cooling, for example through the use of a Peltier element, thus allowing examination of the LED at predetermined temperatures. As can be clearly seen in Figure 1, for increasing temperature the blue emission peak shifts to longer wavelengths and the total emission intensity decreases (the latter effect being typical of LEDs in general). These spectral and intensity changes also cause an alteration in the perceived color. In all industries associated with light emission, perceived color has long been described by the concept of color temperature. Table 1 below shows the calculated effective (i.e. nearest) color temperature for the LED emission illustrated in Figure 1.

Operating Temperature [°C]	Color Temperature [K]
80	3222
70	3203
60	3187
50	3173
40	3161
30	3151
20	3144
10	3141

Table 1: Change in the color temperature T_n for changing operating temperature of a white light LED

Between 20° and 80° C, the effective color temperature is shifted considerably and leads to a significant change in the perceived color. This property of white light LEDs is especially problematic in general lighting applications and hinders the development of qualitative high-grade products.

An additional issue is visible during the burn-in process for LEDs. That is, as long as thermal equilibrium has not yet been reached, the electrical and optical characteristics of the LED also undergo change.

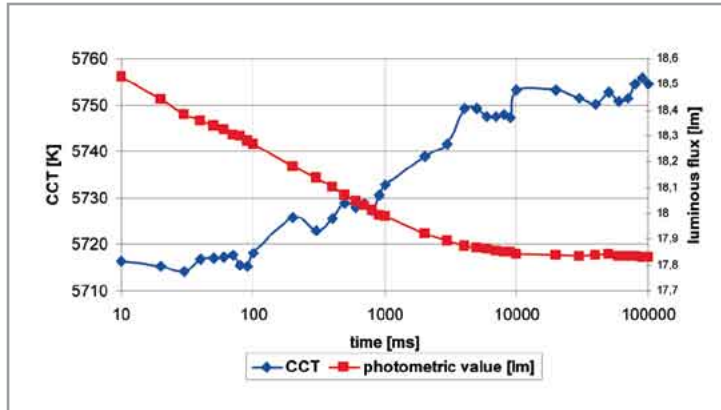

Figure 2: The red squares show the dependence of the total irradiance of a white light LED after switching on, the blue squares show the changing color temperature T_c

Figure 2 illustrates the burn-in process of a white light LED stabilized to 40°C - the photometric luminous flux (black squares) of the LED falls over a period of 10 seconds, while at the same time the effective color temperature rises (white squares). This relatively long stabilization phase must be accounted for if comparison of measurement data is to be made, i.e. measurements made in the production environment can differ from those made under stable laboratory conditions.

The final production step for LEDs is the optical characterization and the subsequent sorting into so-called BINS. Typically, this measurement and classification process occurs 20 to 30ms after the LED is switched on, even if the LED has not yet been thermally stabilized. Nonetheless, the specifications given by the manufacturer in the data sheet usually correspond to this type of production environment measurement. Customers receiving the LED must then often perform their own measurement under stable conditions in order to appropriately characterize the LED for the intended use.

Spatial Radiation Pattern

In order to properly determine their color temperature, the spatial radiation pattern of white light LEDs has to be considered. Contrary to single color LEDs, the perceived color of a white light LED can change as a function of the emission angle. This is a direct consequence of the nature of the technology utilized by the manufacturer to coat the blue LED-chips with phosphors. Differing standards among manufacturers mean that this change can amount to more than 1000 K.

Using a combination of goniometer and spectroradiometer, the luminous intensity distribution and the color temperature can be measured over the spatial radiation pattern of a white light LED. Figure 3 depicts these measurements for both a modern high-power white light LED and a standard 5mm LED.

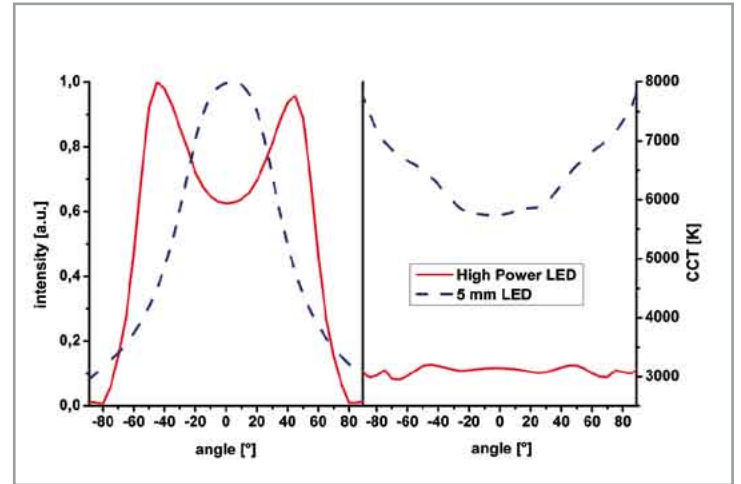

Figure 3: Spatial radiation pattern and color temperature of the emission of white light and standard LEDs, measured at a distance of 250mm

The luminous flux of high-power LEDs is usually measured with an integrating sphere, alternatively the averaged luminous intensities ILED-A or ILED-B. With an integrating sphere, the measured spectrum is integrated over the entire emission hemisphere, whereas a simple luminous intensity measurement only gathers light over a narrow solid angle. If the color temperature is determined under conditions for measuring ILED- B, the result is different to that obtained with an integrating sphere (table 2).

	Color temperature high-power LED [K]	Color temperature 5mm LED [K]
ILED B	3145	5748
Integrating sphere	3112	6804

Table 2: The effective color temperatures for both LEDs as determined from measurement conditions appropriate to that for an integrating sphere and for ILED-B

Were the discrepancy for the measured effective color temperatures of a white light LED as apparent as that for the standard LED (table 2), the measurement geometry used to determine the specifications would have to be indicated appropriately in the data sheet.

Aging of white light LEDs

Modern high-power LEDs require a relatively long burn-in phase until little or no further change occurs over time. The aging process of a 1W white light LED over a time period of 2000 hours is shown in Figure 4 [1].

Over this time frame not only the brightness varies, but also the spectral distribution. During the aging process, the effective color temperature changes by several 100K from 6900 to 6200K.

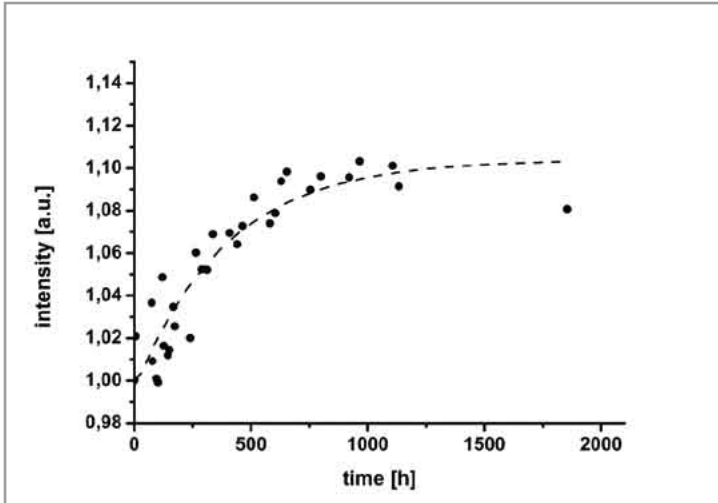

Figure 4: Aging of a high-power white light LED

Lighting manufacturers have to take this behavior into account at the design stage of the product in order to ensure that there are no quality issues associated with degradation of performance. Intelligent feedback and control of the LED over its entire lifetime is one solution to this problem.

Measurement Technology

As highlighted above, spectroradiometers have now become the standard for the measurement of the optical parameters of LEDs. Compared to currently available photometers and colorimeters, spectroradiometers obviate the need for the spectral filters that, through tolerances in the manufacturing process, are often not spectrally matched to the tristimulus curves. However, the optical performance of the spectrometer is also a determining factor for the validity of the measurement result. Two critical parameters are the spectral resolution and the suppression of stray light.

Spectral Resolution

In general, the spectral resolution of a spectrometer can be determined by measuring laser light whose spectral linewidth is much smaller – the resulting “full width half maximum” of the spectrum then corresponds to the spectral resolution of the spectrometer.

For broad-band continuous light sources such as halogen lamps, the spectral performance of a spectrometer has no recognizable influence on the measurement. However, for narrow-band LED sources, insufficient spectral resolution can artificially broaden the measured emission spectrum and thus lead to falsification of the color values.

The emission from white light LEDs usually consists of a relatively narrow band of blue emission superimposed on the spectrally broad emission of the coating phosphor. For proper determination of the effective color temperature, it is important to know the exact height and width relationship for the blue component of the light relative to that of the spectrally broader yellow phosphor. If the spectral resolution

of the spectrometer is too low, the blue range can be falsely represented. Just as for a laser line, the measured blue spectrum of the LED is broadened and the peak reduced. In contrast, the broader, yellowish component of the phosphor emission is not affected. The net result however is a change to the overall spectrum.

The effect that the spectrometer resolution can have on a measurement is illustrated in table 3. The same LED was measured using a spectrometer with variable resolution.

Spectral resolution [nm]	Photometric Integral [cd]	Color Temperature [K]
1	0.877	5699
2	0.875	5695
5	0.872	5692
10	0.873	5676

Table 3: Dependence of the effective color temperature on the spectral resolution

While the photometric value remains more or less unchanged, the effective color temperature shifts by 24 Kelvin. In order to guarantee sufficient accuracy for the measured color coordinates, the spectral resolution of the spectrometer should generally be in the range of 2 to 3nm.

Stray Light

In addition to the spectral resolution, the stray light performance of a spectrometer also plays a critical role for the correct measurement of color coordinates for white light LEDs.

The exact determination of the stray light behavior of a spectrometer over the entire spectral range normally requires the use of a tunable laser source in a complex measurement scheme [2]. However, with help from a halogen lamp and a suitable 450nm long pass optical filter, the stray light suppression afforded by a spectrometer for broad-band light sources can be adequately assessed. Figure 5 shows measurement of the filtered light from the halogen lamp for 3 different spectrometer types – 2 array spectrometers and a double monochromator. The former achieve 2.5 or 3.5 orders of magnitude for stray light suppression, the double monochromator significantly more.

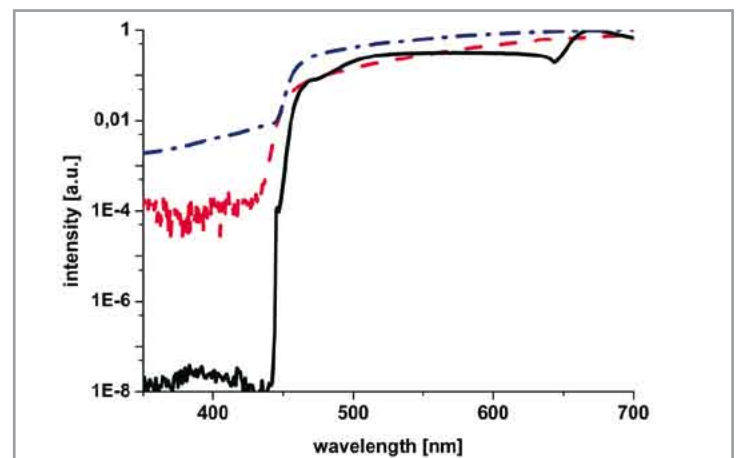

Figure 5: Stray light suppression for different spectrometers for filtered light from a halogen lamp: double monochromator (black), array spectrometer #2 (blue), array spectrometer #1 (red)

In the case of spectroradiometers, these are usually calibrated with the use of halogen lamps with broad-band emission. A common standard, available from almost all national laboratories, is a 1000W FEL lamp with a color temperature of approx. 3100 K.

Halogen lamps have the disadvantage that the emission energy in the blue spectral range only reaches roughly 10% of that at 800nm. The total signal measured per wavelength interval during the calibration process is the sum of the light from the halogen lamp in that same interval plus the stray light component. Insufficient stray light suppression in the blue can thus lead to erroneous values in this region of the calibration file. For the array spectrometer #1, the stray light contribution around 430nm amounts to almost 5%, while that for the reference double monochromator is negligible due to its superior stray light suppression.

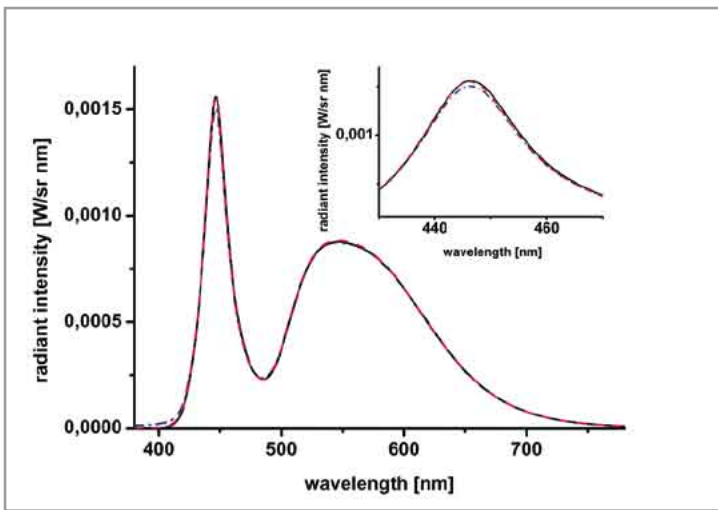

Figure 6: Spectrum of a white light LED measured with three calibrated, but different spectrometers

The effect this can have on measured values for white light LEDs is seen in Figure 6. The spectrum from the same LED as in Figure 5 is recorded by the same 3 spectrometers using coupling optics corresponding to those required for ILED-B measurements. For the array spectrometer #2 (the one with the highest stray light contribution), the blue spectral peak is noticeably smaller than for the other two spectrometers. Normalization of the actual measurement values is made through use of the calibration file, but the erroneous values in the blue spectral region within this file lead to wrongly normalized data in this part of the spectrum.

The color coordinates and the color temperature are affected directly (see table 4), while the photometric values are not.

Spectrometer	Photometric Integral [cd]	x-coordinate	y-coordinate	Tn[K]
Double Monochromator	51.9	0.3169	0.3425	6209
Array Spectrometer #1	52.1	0.3173	0.3444	6186
Array spectrometer #2	51.8	0.3181	0.3453	6138

Table 4: Effect of the stray light suppression of the different spectrometers on the color values

Summary

As the key light source for the future, white LEDs represent a major challenge for optical measurement methods. Factors directly affecting the light source itself, such as operating temperature, the burn-in phase, aging behavior, etc., have to be analyzed and specified properly in order to ensure good reproducibility of the measurements. Furthermore, proper optical parameters for the measurement system also determine whether characterization of LEDs can be made accurately and reproducibly. Differing measurement geometries for the very same LED can also lead to entirely different results. All of these factors have to be accounted before proper internationally comparable quality standards can be established. ■

References:

- [1] Dr. Adrian Mahlkow; O.U.T e.V.; private communication; May 2008
 [2] Yuqin Zong et al; NIST; Simple spectral stray light correction method for array spectrometers, Applied Optics, Vol 45, No 6; Feb. 2008

The Role of Miniature Spectrometers for LED Measurements

> Jorge Macho, Director of Technical Service, Ocean Optics

Fiber optics miniature spectrometers use significant technological advancements derived from the semiconductors industry (detectors), fiber optics, computers and electronics. A decade and a half ago the "primal stew" combining these technologies resulted in a simple device that revolutionized the use of spectroscopic techniques beyond the realm of research laboratories, projecting spectroscopy into the field, industry and even outer space. These light measuring devices have progress from mere technological oddities to trustworthy analytical instruments with great value due to their small finger print, competitive features and low cost.

Miniature spectrometers measure the interaction of light with matter and provide important information in fields that can go from Emission spectroscopy, to find poisonous lead in toys, to Fluorescence spectroscopy used to determine the amount of chlorophyll of crops to determine optimal harvest time. All over the world, these "photonic engines" are the foundation of handheld spectrometers, process control systems or stand-alone units for materials analysis, chemicals identification, optical sensors and other innovative devices. The fiber optic based spectrometers are capable of detecting spectral information ranging from 150 to 2500 nm or more by properly designing the optical bench and selecting the best available detectors. Latest designs can provide the users with resolutions as good as 0.02 nm.

Today we are witnessing another photonics revolution; the advent of LED's as reliable light sources for a large number of applications, going from accurate light sources for life saving medical devices to mega sized screens used in concerts or skyscrapers for entertaining and advertising. The vintage days of LEDs as useful light indicators for electrical device's power status has dramatically changed thanks to the appropriate combination of available state of the art technology, energy conservation trends and low cost of mass production. This emerging multibillion-dollar market requires appropriate standardization of important parameters and characterization techniques in order to appropriately define the industry's baseline. The LED users are requiring repetitive and accurate parameters for emission wavelengths (peak and dominant), color measurement (as related to the human viewer) and power and light flux (inherent and as compared with traditional lighting). Thereby the LED manufacturer, the systems integrator and the final user should use the same measuring devices, standard operating procedures and reference materials to avoid conflicts and streamline the technology behind the LED market.

One of the most important features of an LED is its capacity to emit light at certain wavelength which in time will define its color as interpreted by the human eye. A commonly used scientific definition of color states that is a visible perception dependant spectral energy distribution, interaction of light with the illuminated sample and the spectral response related to the wavelength. How human brain can determine these three parameters accurately is obviously unknown and only highly complicated mathematical models try to accurately define color.

Color a human subjective discernment is now one of the more challenging LED's characterization issues resulting in a LED dedicated "jargon" inherited from other fields and that deal with terms such as: color coordinates, color temperature, dominant/complementary wavelength and very important CRI (Color Rendering Index) and CCT (Correlated Color Temperature). LED characterization becomes more complicated by combining the aforementioned parameters with other lighting industry commonly used measurements such as candelas or luminous intensity (power emitted directionally), foot-candles or Lux (luminous emittance), watts/cm² (irradiance), lumens (perceived power of light) or watts (power).

Traditionally light emitting devices such as light bulbs, fluorescent lights and other use photometers to characterize their optical output. Photometers utilize broadband detectors and optical filters as a way to simulate the spectral luminous efficiency of human eyes. On the other hand, spectroradiometers are devices that can be calibrated to characterize radiant energy as a function of wavelength. The actual photometric values are directly calculated from the measured spectrum with no simulations or mathematical models involved.

In summary, a radiometric measurement results are reported in power units while photometric results are a function of spectral luminous efficiency.¹

Miniature spectrometers have the unique characteristic of being able to work in both worlds. The can be used as photometer with the appropriate filters and algorithms through software and as spectroradiometers in conjunction with light collecting devices such as integrating spheres cosine correctors and others. In the later case, a radiometric calibration of the system is required to achieve the accurate and repetitive radiometrically measurements of LEDs.

Another consideration of prime importance for the characterization of LEDs is their requirement for stable current and voltage. Since LEDs are semiconductors that convert electricity into light trough the appropriate management and design of solid-state doping of the silicon material base to create p-n junctions. The "cold" light emitted by these devices uses electrical energy in a very efficient way since most of the luminous energy radiates in the visible spectral range. In order to maximize the

light emitting efficiency of the LEDs the drive current should be carefully controlled. If the current is too high throughout the chip's junction heat will be generated, not only affecting the LED's efficiency to "convert" electrons into photons but also will damage the crystalline structure of the LED die. If this happens light will not be generated in the overheated and damaged sections creating the so-called "darkling defects".

Miniature spectrometers size and flexibility advantages come into play once again due to their capacity to be controlled by an external computer that can synchronize the spectral acquisition with electrical current management through customized software. This feature proves to be an excellent tool not only for laboratory applications, but also for LEDs manufacturing purposes by providing spectral input and control capabilities to PLC systems. Some examples of these industrial applications are shown in two different industrial sourcing machines in Figure 2. These sorting machines can analyze more than 8,000 pieces per hour. The optical engine behind these devices measures and processes individual LED spectral data within 10 to 50 milliseconds. The instrument's computer quickly processes spectral information; analyzing data for dominant and peak value wavelength, CIE color and irradiance (lumens). Based on these results, the sorter then transports each individual bulb to the appropriate collection bin for storage. Even under rigorous 18-hour workdays, the miniature spectrometers spectrometer are capable of maintaining consistent speed and accuracy.

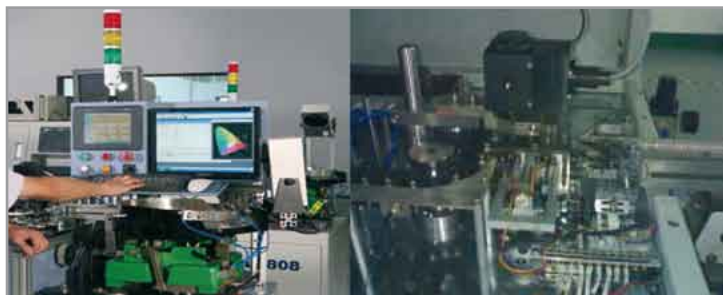

Figure 1: CCD-array miniature spectrometer accurate color measurements in this LED sorting machines

The rapid development of the aforementioned industrial applications of miniature spectrometers is just part of the demand, from different industrial markets, for optical-sensing instrumentation that is more versatile and adaptable than ever, which has challenged technology suppliers to provide rugged, reliable and customized solutions with mass production economics.

Industry is constantly looking for ways better manage their supply chains, reduce waste from off-specification product, increase yields n manufacturing, and build value in the brand or selling of their products. Small savings or subtle

improvements often drive the difference between organic growth and merely surviving. Certainly this idea is not new, techniques such as photometry, visual inspection, and even spectroscopy, such as FT-IR,

are commonly employed by some manufacturers for process control. Unfortunately, there are typically two major disadvantages with these applications: cost and "rigidness of implementation." Purchase and maintenance of equipment is costly, so only the most critical processes employ such systems. The rigidness of implementation refers to the fact that once the equipment is installed, it often is difficult and expensive to change, modify and maintain. Modularity permits dynamic configuration by the user - i.e., conversion of optical and mechanical and is ass simple as screwing and unscrewing spectrometers, light sources and sampling optics foe easy and cost effective modifications and maintenance of the equipment. Furthermore, the miniature spectrometers dependence on the use of optical fibers to collect the light from the sample is also one of their main advantages compared with other larger and complicated spectrometers. Optical fiber can transport light over great distances and around corners, virtually bringing the spectrometer to the sample. The notion of commercially viable fiber-based spectroscopy dates at least to the early '80s, with large fiber optic spectrophotometer developed by Guided Wave, Inc., which was used in chemical, petrochemical and other process industries. Such flexibility of the light analyzing system obviously permits installation on production lines, in process streams, and in injection-molding machines and other LED manufacturing processes besides final product sorting and characterization.

An important advantage of miniaturized spectroscopic systems is that the same exact system can be use in a laboratory for research purposes and scale up to production floors almost instantaneously with no detrimental effects to the results and final application. In Figure 2 we show a typical system for LED optical characterization. The system includes a CCD miniature spectrometer, optical fiber, controlled LED power supply and light collecting fixture, an integrating sphere in this example.

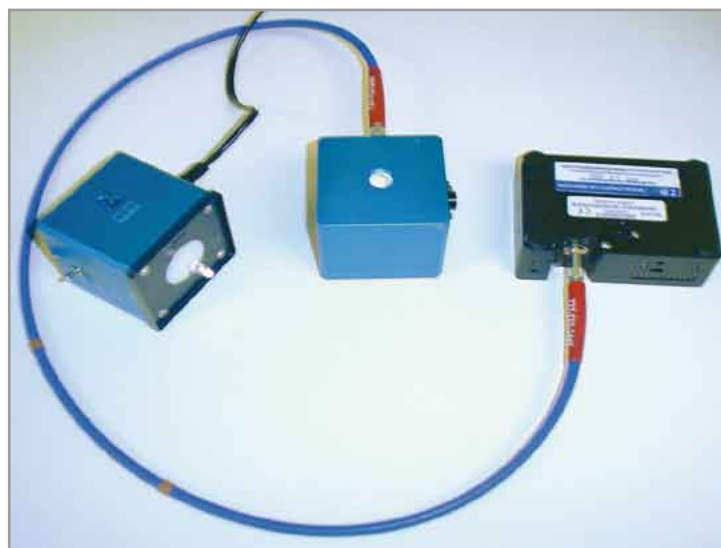

Figure 2: Typical LED characterization set-up with controlled NIST traceable power supply (left), integrating sphere (center) and fiber coupled miniature spectrometer (right)

In the same fashion, the software utilized by the fiber-coupled spectrometer can be customized to be used in a PLC process control system or a sorting machine like the ones previously mentioned. In Figure 3 we show the radiometric results of a white LED. White LEDs are one of the more challenging characterization situations since this lighting fixture will be the ones with the broadest market once their fabrication and light characteristic tuning provide a cost effective option for household illumination and take over the incandescent and fluorescent light bulbs.

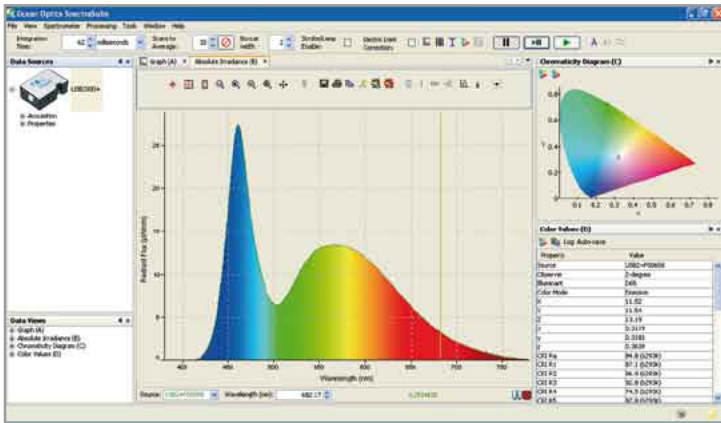

Figure 3: White LED characterization radiometric results, showing spectral features of wavelength (nm) vs. Radiant Flux ($\mu\text{W}/\text{nm}$) as well as the chromaticity diagram and several options for color values

The role of miniature spectrometer in the LED market place does not end with the characterization of the final products but it also plays an important part on the development and characterization of LED's raw materials, from the diodes materials to the phosphor coatings, lenses and other materials ²⁻⁵.

Modularity permits dynamic configuration by the user -- i.e., conversion of optical systems from transmission to reflection or fluorescence, for example, is as simple as screwing and unscrewing spectrometers, light sources and sampling optics from the fibers to which they're attached.

Optical fiber also permits applications not easily implemented with standard optical sensing techniques, such as the measurement of diffuse reflection from solid surfaces. This application requires the exclusion of specular reflection (light coming from an equal but opposite angle to the detector field of view) and is typically accomplished -- as in the case of an integrating sphere -- by removing a port, or by mounting the illuminator and spectrophotometer at different angles (45° and 90°). Using optical fiber, it is possible to overlap the illumination and detection fields in a small, easily deployed reflection probe. When the probe is positioned at 45° to the surface, only diffuse reflection is sensed. At 90°, diffuse plus specular reflection is sampled. In addition, the sampled area can be made larger or smaller by changing the sample-to-probe distance. Spot sizes as small as the characters on this page can be measured. The same optical fiber reflection probes can be used to measure thin films by interferometry as shown in Figure 4 which a

system specially designed for this purpose and commonly use to characterize coatings used in LED lenses and windows. Once again, the heart of this device is a miniature spectrometer, light source and customized software as shown in Figure 5.



Figure 4: Thin film characterization system, utilizes interferometry and special software to measure thin film thickness directly in large samples or in small samples by adapting the fibers probes to a microscope

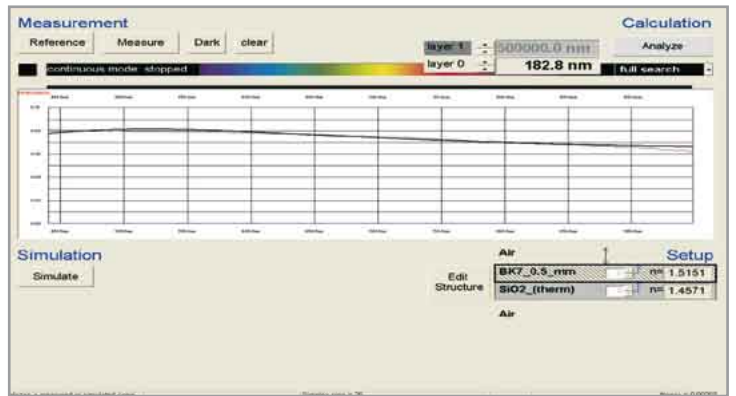

Figure 5: Thin film thickness measurement of a silicon film on a glass substrate

Again, the size and flexibility of the devices makes them suitable for scale up applications and with the appropriate accessories the systems are used in vacuum chambers for monitoring real-time thin-film deposition at the laboratory or on industrial environments.

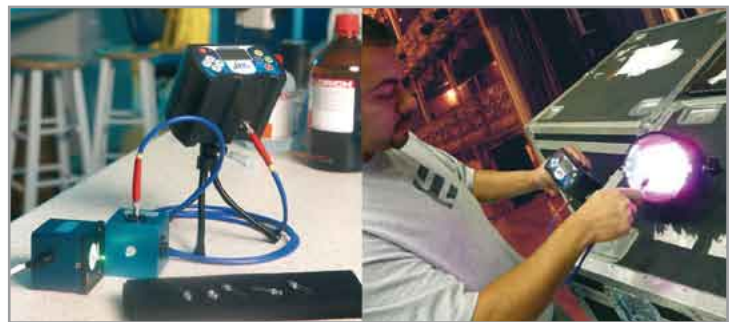

Figure 6: Portable spectrometer measuring single LEDs(left) that will be used for entertainment light fixtures as the one shown at a concert hall on the right photograph

LEDs started as low intensity low quality lighting options derived as scientific curiosities of the semiconductor industry research and development efforts. Miniature spectrometers had their roots in the same semiconductor field that paved the road for the development of

efficient detectors originally designed for the telecommunications industry. These two innovative photonic fields that developed from an industry that is now considered commoditized have the potential to develop new and interesting applications thanks to the relentless advances of related technologies.

All the advances in spectroscopy of the last decade -- the breakthroughs in optics, detectors and fibers -- could be the tip of the iceberg. Today, there are spectral sensors that are very small, consume little power and have built-in communications protocols and electronics that allow it to "talk" over the Internet. This spectrometer-as-Web appliance could have an enormous impact on research, industrial and field measurements, with implications for everything from how we combat the outbreak of disease all the way up to provide us with better entertaining options such as TV sets, OLED screens or architectural illumination. The same device that is used to measure single LEDs in a laboratory and then transferred to fine-tune the illumination provided by an LED spot fixture at a concert hall can be used to characterize the Red and NIR LEDs used to monitor oxygen in blood at hospital patients. These smart and innovative portable spectrometers will standardize the spectrometric measurements that control the production of LEDs and OLEDs at the manufacturer's plant with the portable spectrometers that will be used to confirm the quality of such LEDs at their final use and destination. The final user, from hospitals to automotive dealership repair shops would be able to negotiate their require LED's parameters based on the same spectrometer, which will be calibrated and customized by the LED manufacturer for their customer's use. Using the "same ruler" for the same measurement at remote places. A good example of this concept is shown in Figure 6 where a JAZ® portable spectrometer is used to characterize the LEDs that ended out being part of an LED light fixture used at a concert hall. On the same principle spectrophotometric devices such as the "Color Bug"®, featured in Figure 7, which can provide measurements for color (CIE 1931; x,y,z) and luminance values Lux/fc communicating the results wirelessly to an iPhone® or iPod® devices.



Figure 7: Handheld spectrophotometer with the latest advances in wireless communications and compatibility with other common handheld devices such as the iPhone

Photonics markets such as the LED industry and the miniature spectroscopy markets value ease of use, convenience, timesavings, quality and continuous innovation. What will distinguish top industrial photonic systems providers is the ability to rapidly develop application-specific systems. Specifically, spectroscopy-based devices like the ones mentioned in this publication provide the framework for such systems. Portable, independent and "smart" instruments that have all the advantages of spectroscopy --including multi-channel capability -- plus features like a microprocessor and onboard display that eliminate the need for a PC; stackable, autonomous instrument modules that make it simple to customize the system to changing application needs; and Ethernet connectivity for remote operation. That's a lot of functionality required around one core spectroscopy technology. Just as the functionality expected around LED based lighting and devices. ■

References:

- 1) Measurement of LEDs, Commission Internationale de L'Eclairage, CIE 127:2007 2nd Edition.
- 2) P.Thiyagarajan, M.Kottaisamy and M.S.Ramachandra Rao, J.Phys.D:Appl. Phys. 39 2701-2706
- 3) Xueying Wang, Hai Lin, Changmin Liand Setsuhisa Tanabe, Meas. Sci. Technol. 18 1348-1352
- 4) P. Thiyagarajan, M. Kottaisamy, and M S Ramachandra Rao, Material Research Bulletin, 42-4, 2007, Pages 753-761
- 5) J. Park, Growth and Characterization of GaN and AlGaN Thin Films..., Dissertation for North Carolina State University, 2005.

Technology

LED Encapsulant Epoxy Curing Optimization

> Bit Tie Chan, Avago Technologies - Optoelectronic Product Division

Cured epoxy polymer is a thermoset plastic that is created by combining a resin made of chains of epoxide rings with an appropriate hardener. Epoxy hardeners are not catalysts, and their specific reaction with the resins greatly contributes to the ultimate properties of the cured epoxy resin system. The curing profile of the mixed resin and hardener also affect the properties of the resulting cured material. The specific characteristics required of a cured epoxy depend on the application.

This article presents an approach to optimizing the curing profile of the optical grade resin-hardener system used to encapsulate a surface-mount PLCC-2 (plastic leaded chip carrier - two lead) LED package. Following the initial experimental results, the samples were subjected to thermal cycling tests to validate the performance of the recommended optimum curing profile.

Introduction

Epoxy resins, widely used in insulators in electrical and electronic applications, offer great versatility in properties and cures. These resins can be cured at ambient or elevated temperatures, depending upon the choice of curing agents. In the two-part formulation, the resin and hardener are mixed immediately before the encapsulating application. The cure kinetics and the glass transition temperature (T_g) of the cured system are dependent on the molecular structure of the hardener (the glass transition is the temperature where the polymer goes from a hard glasslike state to a flexible state). The physical characteristics of the epoxy resin system that influence the behavior of hardeners include atmospheric temperature, curing temperature and relative humidity. In many cases, more than one step is recommended for curing epoxy used for encapsulation. The first curing step determines the properties of the cured epoxy, and a relatively low temperature is usually recommended to reduce the internal stress. The second (or sometimes third) step in curing is used to enhance the adhesion bond between the epoxy and the substrate. The second step curing temperature is usually 10°C to 20°C higher than that used for the first curing step.

The curing profile recommended by the epoxy supplier might not be the optimum for a specific application. It is crucial to determine the optimum profile and mix ratio for the particular application to ensure the optimal performance of the cured epoxy. This article presents work that has been done to determine the optimum curing profile and mix ratio of a bisphenol A resin and anhydride hardener system used in surface-mount technology (SMT) LED packages. A PLCC-2 (Plastic Leaded Chip Carrier

- two lead) package was used as the vehicle in this study (Figure 1). This package has a substrate made up of a molded plastic reflector sitting on top of a bent lead frame. The die is attached within the reflector cavity and the cavity is encapsulated using the epoxy blend.

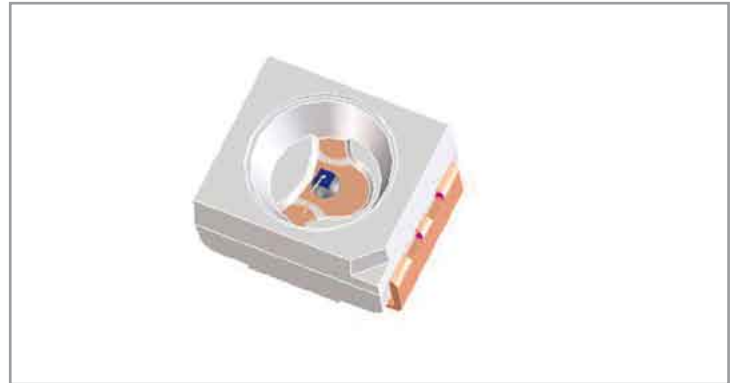

Figure 1: Subject PLCC LED Package

First, the isothermal cure kinetic of the specific epoxy resin was examined to study the catalyst kick off temperature and the maximum curing temperature. The pre-cure temperature can be predicted from the initial catalyst kick off temperature, and the maximum cure temperature helps to determine the post-cure temperature. Next, the epoxy resin was soaked at different combinations of temperature and time to determine the optimum post-cure duration. An internal stress analysis of the cured epoxy was then performed at different pre-cure durations to finalize the optimum curing profile. Finally, the samples were subjected to a thermal cycle test after moisture soak at 85°C/60% relative humidity (RH) to validate the performance of the recommended optimum curing profile.

Experimental Approach

Methodology

Differential scanning calorimetry (DSC) experiments were performed on the liquid epoxy resin using a Perkin Elmer Pyris 6 DSC instrument to investigate the cure behavior of epoxy. In the two-part formulation, the components are mixed right before the encapsulating application occurs. The mix ratio recommended in the technical datasheet was used in this study. The DSC sample size was in the range of 10-14 mg. The DSC scan was performed between +30°C and +250°C at a constant heating rate of 10°C/minute to investigate cure behavior of the resin. The glass transition temperature (T_g) is also determined using the Pyris 6 DSC, with the same scanning rate.

To obtain the thermal transition characteristic of the epoxy resin after curing, a dynamic mechanical analysis (DMA) was performed using a Perkin Elmer Pyris 7 DMA instrument in single cantilever beam mode. The DMA scan was performed between +30°C and +250°C at a constant heating rate of 5°C/min. To obtain data on the dimensional change of the epoxy, a thermomechanical analysis (TMA) was performed using the penetration mode, and scanned from +30°C to 250°C at a constant heating rate of 5°C/min.

Isothermal cure kinetic

Displayed in Fig. 2 are the DSC isothermal cure curves for the epoxy resin at different isothermal temperatures. The epoxy resin was heated from +30°C to +250°C at a constant rate of 10°C/min. at +110°C, +120°C, +130°C, +140°C and +150°C. As shown in Fig. 2, exothermic reaction peaks at +110°C and +120°C were not detectable. This implied that the catalyst reaction was not started at these temperatures. The catalyst started to kick off at +130°C, as denoted by the small peak in Figure 2. The maximum curing reaction was observed at +150°C. This explanation was supported by the glass transition temperature (Tg) measurement in the second DSC scan. In Appendix 1, a significant uncured peak was observed at +110°C and +120°C. The extent of cure (cure percentage) is calculated by:

$$\frac{\Delta H \text{ of uncured epoxy} - \Delta H \text{ of uncured peak of cured epoxy}}{\Delta H \text{ of uncured epoxy}} \times 100\%$$

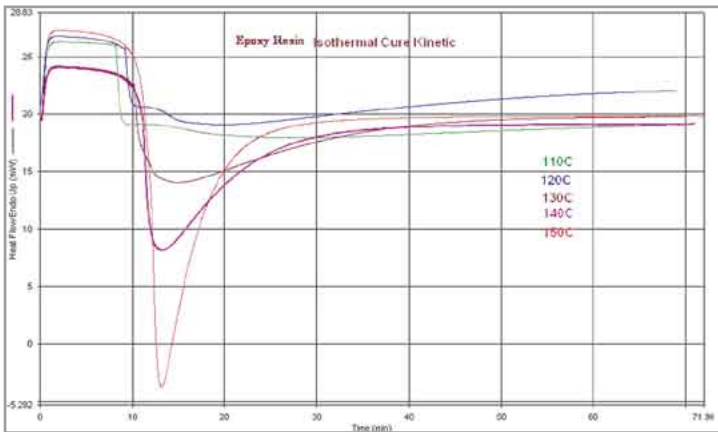

Figure 2: DSC isothermal cure curves for epoxy resin

Table 1 summarizes the percentage of cure and glass transition temperature (Tg) at different temperatures. The table shows that +110°C +120°C can be ruled out as pre-cure temperatures due to the presence of high degree of uncured reaction.

Note: Uncured ΔH = 410.88J/g from the liquid DSC thermogram

Temp. °C	ΔH of uncured/ J/g	% cure
110	107.565	73.8%
120	26.672	93.5%
130	9.694	97.6%
140	0	100.0%
150	0	100.0%

Table 1: Percentage of cure vs. temperature

Soak time study

Five samples that were cured at different temperatures (+110°C / +120°C / +130°C / +140°C / +150°C) were then subjected to cure at soaking time of two, four, six and eight hours to figure the optimum cure condition. The pre-cure and post-cure condition was then be derived from this study.

Table 2 and Figure 3 summarize the Tg of this study. The values for Tg at +130°C, +140°C and +150°C are equally stable over time. This is in line with isothermal cure kinetic study results where the catalyst starts to kick off at +130°C. As suggested by the isothermal cure kinetic study, this epoxy resin reaches the maximum cure at +150°C. Hence, a post-cure temperature of +150°C was identified as optimum. The glass transition temperature was stable from four to eight hours of curing at a temperature above +130°C. Hence, a five-hour curing time was recommended for the post-curing duration. Based on this study, +150°C for five hours was then identified as optimum post cure condition, and was used in the subsequent study to determine the pre-cure condition.

Temp (°C)	Cure Time (hr)		
	2	4	8
110	97.6°C	109.1°C	112.7°C
120	113.5 °C	121.0°C	125.2°C
130	125.4°C	126.6°C	127.8°C
140	127.8°C	128.1°C	128.5°C
150	129.8°C	129.9°C	131.1°C

Table 2: Glass Transition Temperature (Tg) of epoxy resin soak time study

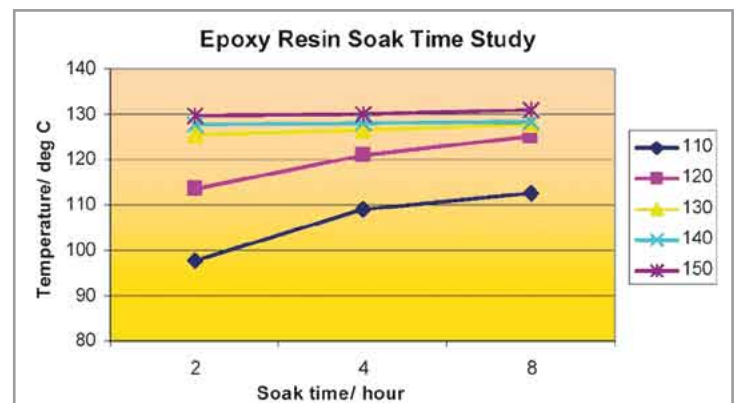

Figure 3: Glass Transition Temperature (Tg) of epoxy resin soak time study

Determining pre-cure conditions

Pre-cure temperature is an important indicator for the reactivity of the resin mixture. The higher the pre-cure temperature, the higher the Tg. Too low a pre-cure temperature leads to low resin reactivity, and the polymer cross-linked structure cannot be fully formed. This causes risks to reliability, such as the potential for broken bond wires. Too high a pre-cure temperature gives high reactivity to the resin mixture and the potential to build up high internal stress in the epoxy network. This affects reliability by yielding the possibility of cracks or delamination.

Thermo-mechanical properties of this epoxy resin under three different pre-cure conditions as listed below were then studied to determine the optimum pre-cure profile for PLCC package.

- pre-cure: +135°C for 0.5 hr and post-cure: +150°C for 5 hrs
- +135°C for 1 hr and 150°C for 5 hrs
- +135°C for 2 hr and 150°C for 5 hrs

Table 3 and Figure 4 summarize the thermo-mechanical properties of the epoxy resin at different pre-cure conditions. The results suggests that +135°C/ 1 hr and 150°C/ 5 hrs represents the optimum curing profile, with lower internal stress compared to +135°C/ 2 hrs and 150°C/ 5 hrs. Curing at 135°C/ 0.5 hr and +150°C/ 5 hrs was out of consideration as the percentage cure after the pre-cure stage was <95%. The potential for the material to absorb moisture is high if the percentage cure is too low as the cross-linking was not completely formed.

pre cure	post cure	T _g /°C	CTE / ppm/°c		Cure %	
			CTE1	CTE 2	after pre-cure	after post-cure
135°C/0.5H	150°C/5H	134.4	69	157	81.2%	100%
135°C/1H	150°C/5H	135.4	69	159	97.8%	100%
135°C/2H	150°C/5H	136.4	73	100	100.0%	100%

Table 3: DSC and TMA results on epoxy resin at different pre-cure condition

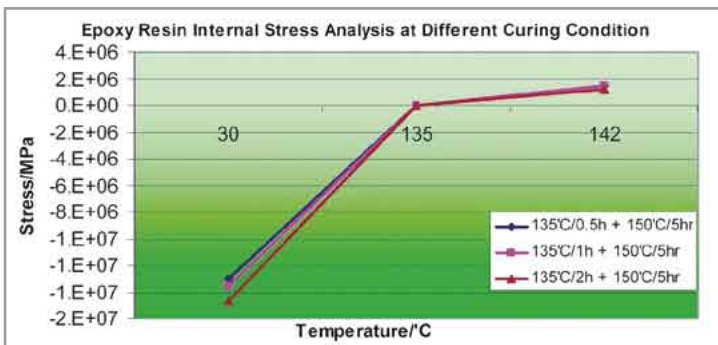

Figure 4: Internal stress on epoxy resin under different pre-cure conditions

Reliability Results and Discussion

Thermal stability of epoxy resin over time (process)

In order to further validate the thermal stability of the product at different process after curing with the recommended profile, i.e. 135°C/ 1 hr and 150°C/ 5 hrs, the T_g from a few evaluation lots that were built at different times was taken after each process of PLCC-2 packages. As displayed in Fig. 5, the T_g change was within 5°C from after the curing process to after three IR reflow cycles. It can be concluded that the package is stable over time (processes).

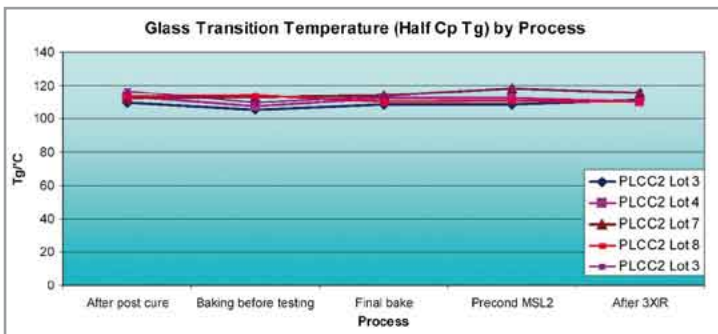

Figure 5: Change of glass transition temperature (T_g) over time (processes)

Reliability test results

Table 4 summarized the reliability test result the epoxy resin that cured with the recommended profile at 135°C/ 1 hr. and 150°C/ 5 hrs in temperature cycle (-55° C to +100°C), wet hot storage life test (85°C/ 85% RH) and wet hot operating life test (WHTOL 85°C/ 85% RH) after preconditioning at 85°C/ 60% RH for 168 hrs. All three tests pass up to 1000 hours. This further revealed that the recommended profile is optimum for the PLCC-2 packages under this study.

Test	Test Point	Result
MSL2 (85°C/60% RH) + 3xIR + TMCL -55°C/ +100°C	1000 hrs	Pass
MSL2 (85°C/60% RH) + 3xIR + WHTSL (85°C/85% RH)	1000 hrs	Pass
MSL2 (85°C/60% RH) + 3xIR + WHTOL (85°C/85% RH, 20 mA)	1000 hrs	Pass

Table 4: Summary of reliability results

Conclusion

This study illustrated approaches that can be used for LED encapsulant epoxy curing profile optimization. The results clearly show that the evaluation results support the theory and hypothesis and it provides promising results to the actual performance. Thermal stability over time and the epoxy internal stress are the main considerations in optimum curing profile determination. The optimum curing profile is crucial to establishing long term package reliability. ■

Acknowledgment:

The author would like to thank Margaret Tan Kheng Leng for providing the support and information needed to write this article.

References:

- [1] W. J. SiChina, Better Isothermal Cure Kinetics Studies Using Power Compensation DSC, Perkin Elmer Instruments
- [2] W. J. SiChina, Characterization of Epoxy Resin Using DSC, Perkin Elmer Instruments

Appendix:

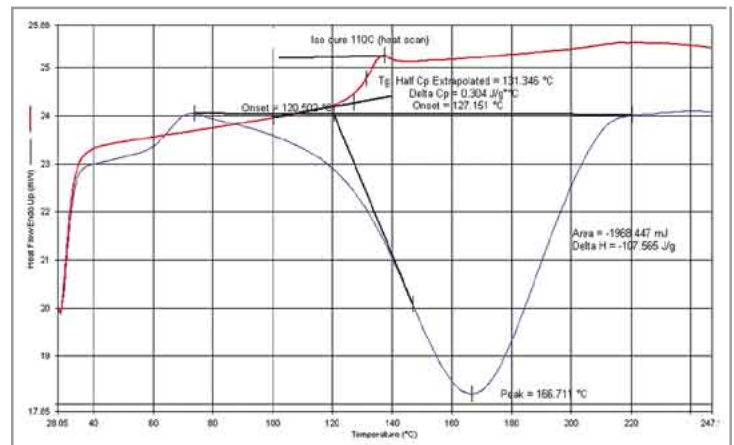

Fig. 1: Isothermal Cure: 110 °C

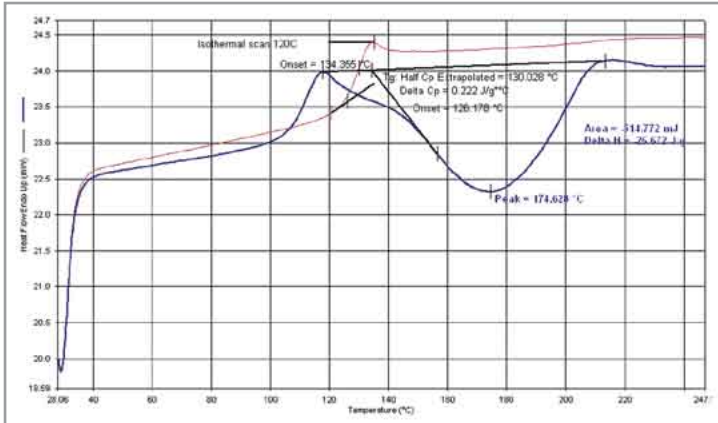

Fig. 2: Isothermal Cure: 120 °C

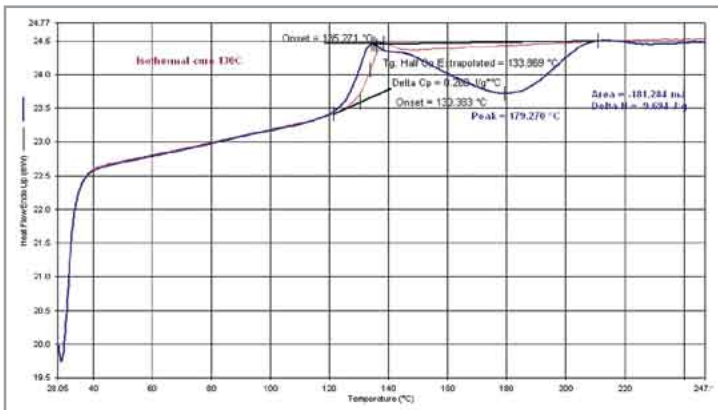

Fig. 3: Isothermal Cure: 130 °C

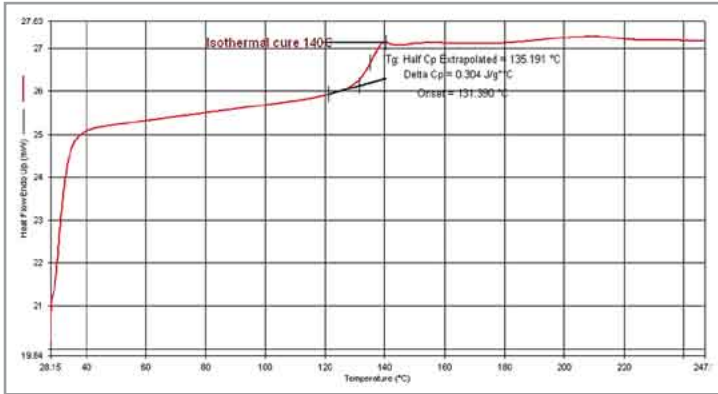

Fig. 4: Isothermal Cure: 140 °C

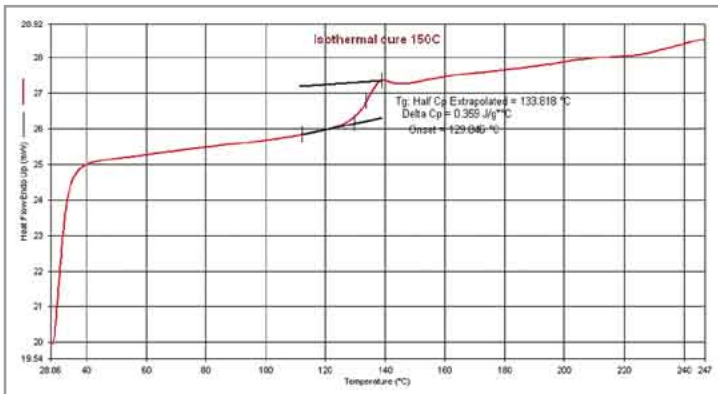

Fig. 5: Isothermal Cure: 150 °C

The Power Behind SMART LED Lighting

LED DRIVERS
LED MODULES
CUSTOM POWER SOURCES & CONTROL ELECTRONICS
EVOLUTIONARY POWERING SCHEMES
COMPLETE PACKAGES

ROAL
living energy

ROAL's Solid State Lighting products unlock the true benefits of LED based lighting and reduce the time to market with integrated high performance electronics, short design cycles and low cost manufacturing services. High brightness LEDs convert electricity into visible light. We do the rest.

POWER VECTOR
ENGINEERED LED POWER

IRIS • TRINITY • LED DRIVER/DIMMERS

DIMMABLE LED POWER SOLUTIONS
3-IN-1 LED DRIVER/DIMMER • POWER ISOLATION • ANALOG OR DMX512A • CONSTANT CURRENT

TRINITY 6 LED Driver Dimmer™

- 240 watts: 87% efficiency
- Unique dimming technology (patent pending)
- Superior low level dimming
- Class 2 outputs
- Analog dimming (0-10vdc) option
- DMX512A USITT Compatible dimming option
- 12, 9 and 6 channels (700mA, 1A, and 1.4A) Constant Current outputs
- DMX and Analog daisy chainable

IRIS LED Driver Dimmer™

- 86 watts: 80% efficiency
- Unique dimming technology (patent pending)
- Superior low level dimming
- Class 2 outputs
- DMX512A USITT Compatible option
- 8, 6, 4, 3, and 2 channels (350, 500, 700mA, 1A and 1.4A) Constant Current outputs
- DMX daisy chainable

www.powervector.com • info@powervector.com • Tel: 1-888-LED-3IN1 (533-3461)

Optics

LED Source Modeling Method Evaluations

> Mark Jongewaard, Director of Engineering, LTI Optics; Kurt Wilcox, Engineering Manager, Ruud Lighting

Producing accurate simulations of LED based optical systems requires accurate source models. This means the source models must not only produce the correct distribution of light in a far field measurement, they must also produce the correct near field behavior since secondary LED optics are often employed in very close proximity to the LED. Accurate simulations are vital to the design process especially with lens optics commonly used on LEDs given the high cost and long lead times for lens tooling. The data presented in this paper is a direct result of the lessons learned by one manufacturer about the importance of simulation accuracy.

Overview

3 main source modeling methods¹ can be used, having a very different approach:

Type 1 - Luminance data that is based on calibrated digital images taken from viewpoints all around the source. There is no geometry included with this type of source model. The image data is used to create 3D rays representing the initial emanation of light from the source. Figure 1 shows one of many images taken of an LED. The image was viewed in Radiant Imaging's ProSource™ software.



Figure 1: Calibrated Image of LED

Type 2 - Goniometric intensity distribution with source geometry and surface luminance data. This type of model distributes ray emanation points across the luminous surfaces of the source geometry considering the relative luminance values of the various source surfaces. The ray directions are determined by the intensity distribution assigned to the source, which is generally a measured far field distribution.

Type 3 - Self-generated intensity distribution resulting from detailed source geometry and luminance data. An example of the source model geometry for the Seoul Semiconductor P4 LED in Photopia's source library is shown in Figure 2. This type of model uses the luminance data for the LED chip itself to generate initial rays, which then interact with the surrounding primary optical components such as reflectors and lenses. This type of model creates the most accurate representation of the source behavior, that is to say the most accurate 3D ray emanation points and directions, since it replicates the actual light paths from the chip out of the primary optics.

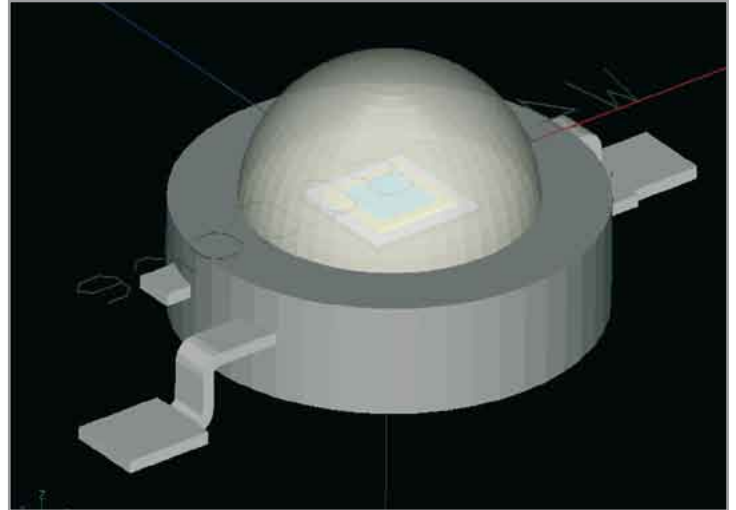

Figure 2: Type 3 Source Model Geometry

As previous work¹ documents, Type 1 & 2 source models have a limited range of applications in which they can be used before loss of accuracy is experienced. The purpose of this article is to present 3 case studies that compare the use of these 2 source model types to show their relative performance. This is very important in cases where a designer has both types of source models available for a given LED and needs to know which type will produce more accurate results for their project. Furthermore, it is important to understand the expected level of accuracy when only a Type 1 source model is available.

Type 1 models are commonly used for LEDs since many LED manufacturers distribute 3D ray sets built from the digital images and as a result, many optical software products do not see a need to create separate Type 3 models. While several companies offer services to measure the digital images, the results in this paper are based on image data measured by Radiant Imaging. Type 3 models are commonly used only when they are provided in the source library distributed with the optical software.

To illustrate the differences in the way rays are generated between a Type 3 and 1 model, Figures 3 and 4 show the CREE XR-E LED model which is included in the Photopia software library. The left side of each image shows the light field inside the LED while the right side shows the source geometry. In the Type 1 model, the geometry is only for reference as it is not part of the model. The location of the LED chip is near the top of these images, just above the bright region of light in the Type 3 model image.

Edixeon® ARC Series

High Power LEDs

- High Performance
- High Quality
- Reflow Compatible

Edixeon® ARC series, a production-ready, 100lm packaged light source. Driven at 350mA, It is the first of its kind to truly achieve luminous efficacy over 100lm/W at cool white LED (CCT: 5,000K~10,000K).



Cool White :

1LS5 350mA 100lm/W

3LS5 700mA 170lm/W

Edixeon® _Federal Series

Small Type SMT LEDs

- Size : W 4.5 × D 3.0 × H 1.8 mm
- Reflow Compatible
- Moisture Sensitivity : JEDEC 1

Edixeon® F series, a small type SMT LED, 80lm packaged light source. Driven at 350mA, Edixeon® F Series is a compact and surface mount power LED with an exceptional luminous flux output. Its miniature structure brings freedom to designers for shaping new generation of lighting fixtures.

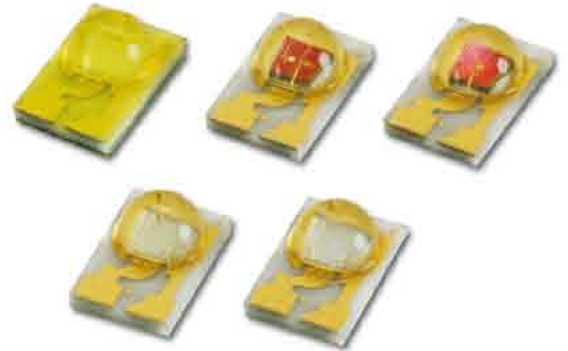

Cool White :

350mA 80lm

700mA 136lm



www.edison-opto.com.tw
service@edison-opto.com.tw



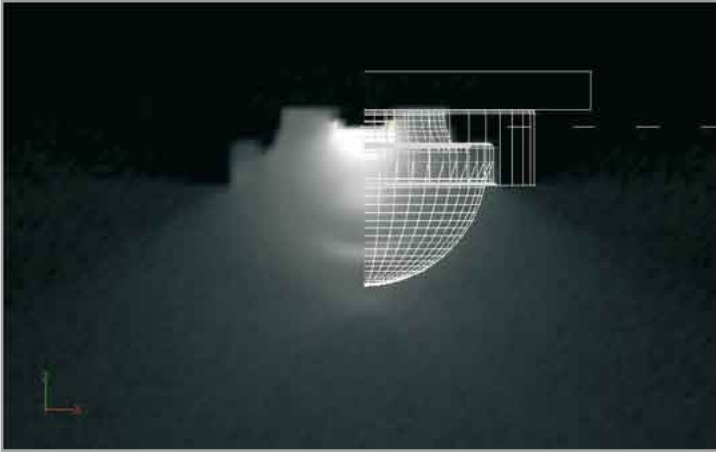

Figure 3: Type 3 Source Model

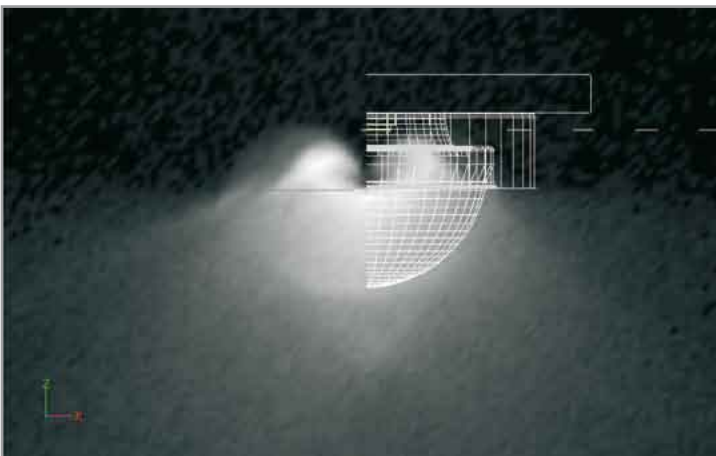

Figure 4: Type 1 Source Model

Artifacts in the light field as a consequence of the specific methods used to create the 3D ray emanation points in the Type 1 model are clearly seen in Figure 4. The light field is generated in a region well in front of the actual chip location. To understand why such artifacts are present, one must understand how the 3D rays are generated from a set of digital images. The digital images are collected from many viewing angles around the source. These 2 dimensional images all center around some reference point on the source. For this LED, that reference point is in the center of the metal ring, near the base of the glass dome. From this set of 2D image data, 3D emanation points are determined. As seen in Figure 1, precise data is available in the plane of each image so the local X & Y values for a ray point can be determined, but no data is explicitly known about the 3rd dimension, essentially the Z value of the ray out of the plane of the image. The software that creates the 3D ray sets provides various geometric surface options to which the 3rd dimension can be mapped. Figure 4 uses the "undefined" option since it is often used in the ray sets distributed by the LED manufactures, which makes it a good reference for these case studies.

Case Studies

These case studies use data collected by BetaLED™ during the development of their NanoOptic™ LED outdoor area lighting lens optics. The data includes measured luminous intensity distributions along with simulations using both Type 1 and Type 3 source models in Photopia. The optics were measured at Independent Testing Laboratories, Inc. (ITL) in Boulder, Colorado, USA. The simulations used lens geometry that was scanned from the physical as-built parts. This is important since the as-built parts did not always perfectly match the intended design, which removes a potential source of difference between measured and simulated performance.

Case 1 – Roadway Type 5 Distribution Lens (Wide round pattern optic with a gel filled gap between LED and lens)

Figure 5 shows very significant beam deviations between the measured (blue) and simulated (red) data for the Type 1 model, especially in the higher angle range. This is a critical part of the beam on this type of optic since the goal is to direct as much light as possible just below the cutoff angle of 80 deg. If the simulations are under predicting these values, then the optimization of the optic will be misdirected. The Type 3 model plots in Figure 6 show closer correlation to the measured data, especially in the higher angles. The lower angles do deviate from the measured data, but generally follow the same trends in the beam pattern.

Case 2 – Roadway Type 5 Distribution Lens (Wide round pattern optic without gel)

The differences between the Type 1 and Type 3 model performance are not as great as in the first optic, but the Type 1 model in Figure 7 does show an upward shift in the beam angle and significantly more light directly below the luminaire. Accurately predicting the peak vertical angle in the intensity distribution is another critical issue in this type of lens. Figure 8 shows more accurate overall beam shapes as well as peak beam angles.

Case 3 – Medium Beam Lens (With a gel filled gap between the LED and lens)

This case illustrates how the differences between the 2 model types remains significant when a gel is used between the LED and lens even in a much narrower beam distribution. The higher intensities seen in the central part of the beam using the Type 1 model in Figure 9 result from the extra lumens that were not directed to the higher angles in the distribution where they belonged. The Type 3 model results shown in Figure 10 show a much closer beam shape at the full range of angles in this distribution.

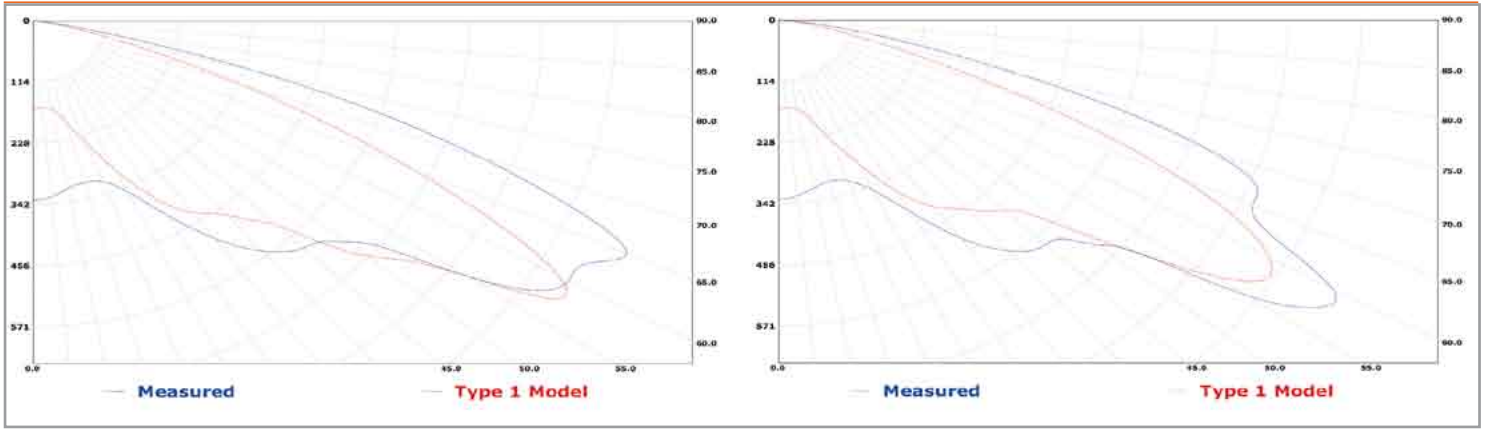

Figure 5: Type 1 Model Simulations: polar candela plots along chip (left) and diagonal to chip (right)

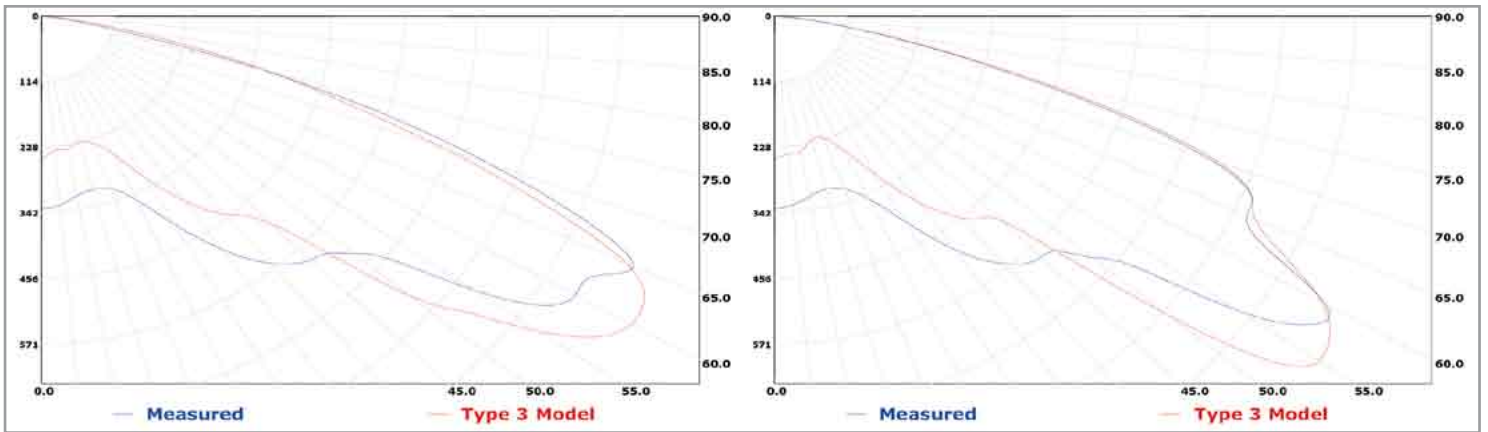

Figure 6: Type 3 Model Simulations: along chip (left) and diagonal to chip (right)

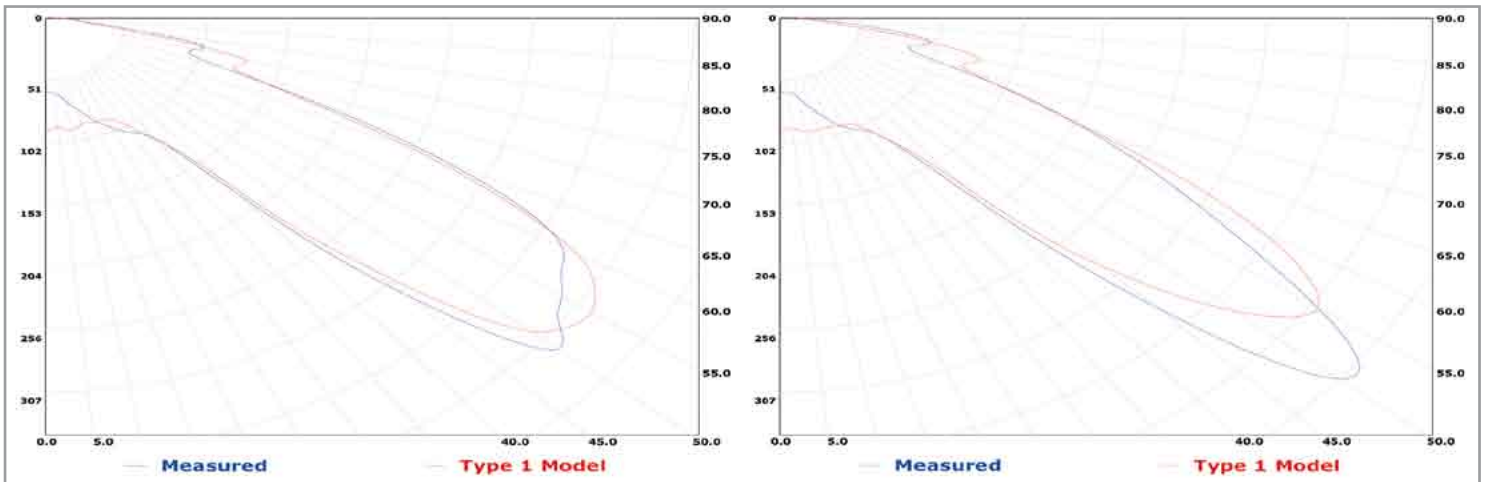

Figure 7: Type 1 Model Simulations: polar candela plots along chip (left) and diagonal to chip (right)

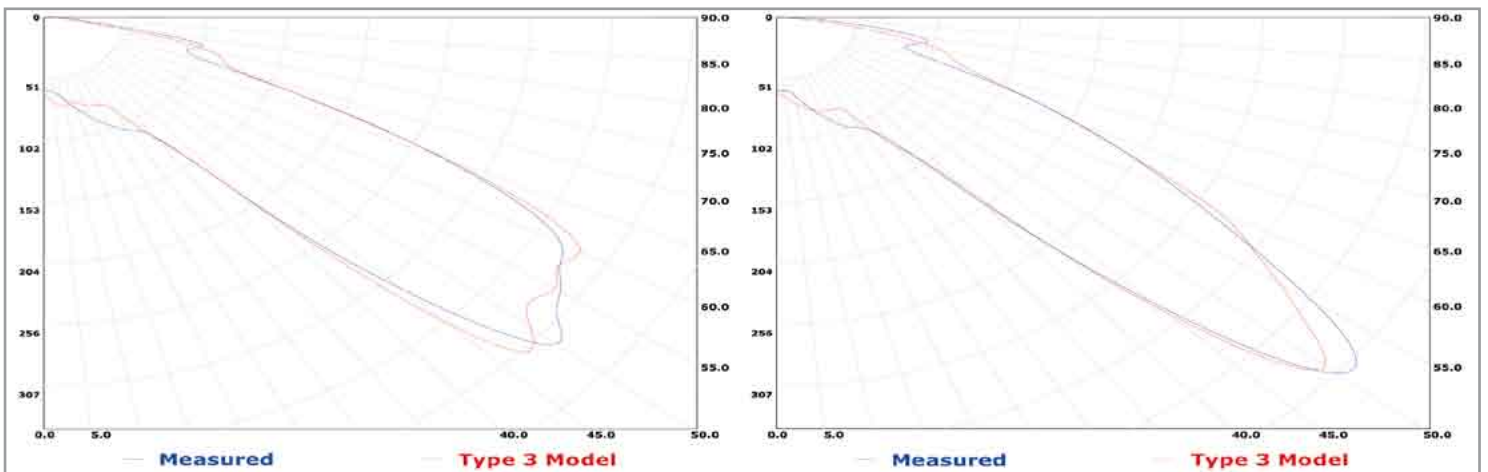

Figure 8: Type 3 Model Simulations: along chip (left) and diagonal to chip (right)

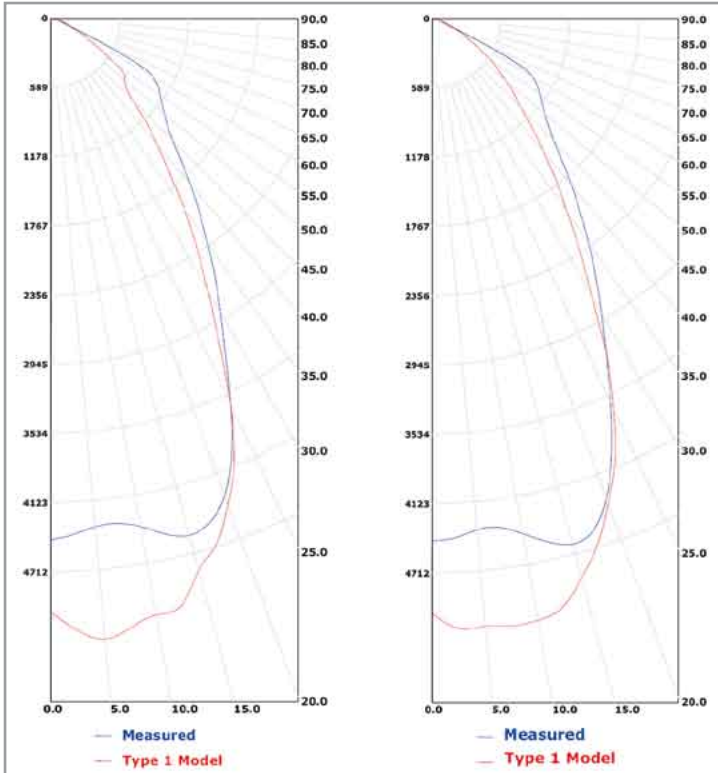

Figure 9: Type 1 Model Simulations: polar candela plots along chip (left) and diagonal to chip (right)

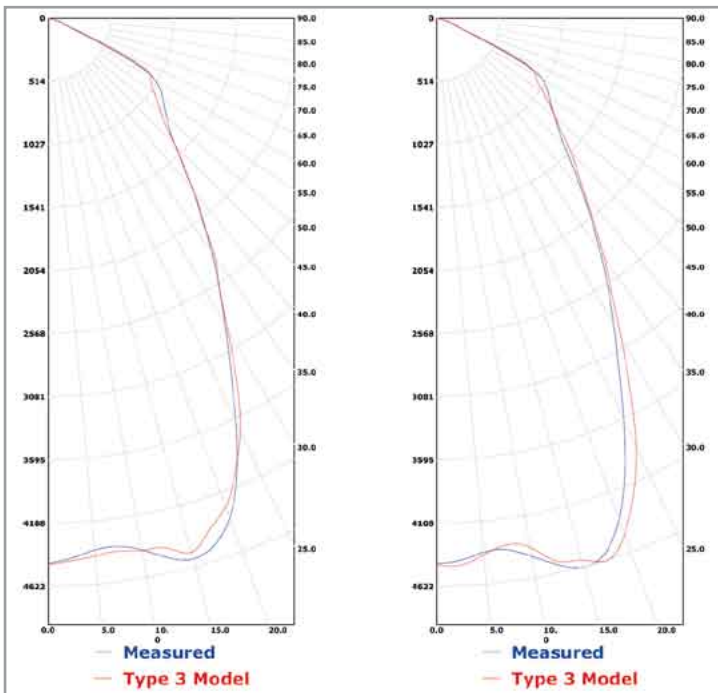

Figure 10: Type 3 Model Simulations: along chip (left) and diagonal to chip (right)

Summary

The 3 cases presented illustrate that there are significant differences in simulated results depending on the source modeling method used. These results show that a Type 3 model more closely matches the measured performance than the Type 1 model for both wide and medium beam lenses. The differences are greatest when an index matching gel is used between the LED and lens. The main reasons for this are that in addition to the challenge Type 1 models have in creating accurate 3D ray emanation points, all of their digital images showing the luminous view of the source are measured in air. When a gel is used between the LED and the lens, light never exits from the LED primary lens into air so the measurements are inappropriate. Since Type 3 models include the lens geometry, the material can simply be changed to account for the glass / gel interface instead of glass / air.

The 2nd set of data shows that the Type 1 model fares better when there is no gel, yet it does not outperform the Type 3 model. Wider beam optics are more sensitive than narrower beam optics to exactly how much light is directed onto each part of the lens. As the beam gets narrower, more light is directed to the same angles in the beam and differences in the amount of light sent to each part of the lens between the simulation and physical reality become less important. It should also be noted that other 3D ray emanation point geometry mapping options were tested such as mapping the points to a sphere and the results did not vary significantly from those presented here.

Given a choice between Type 1 and Type 3 source models for the same LED, a Type 3 model will likely produce more accurate results, especially as the beam gets wider. If gels are used between the LED and lens, then Type 1 models should not be used since the measurements on which they are based is not appropriate for this situation. ■

The logo for the 2009 LED Lighting Taiwan exhibition. It features the word 'LED' in large, stylized letters where the 'L' is red, the 'E' is green, and the 'D' is blue. To the right of 'LED' is the year '2009' in a similar color scheme. Below 'LED' is the word 'LIGHTING' in a smaller, white, sans-serif font. Below 'LIGHTING' is the word 'Taiwan' in a large, white, sans-serif font with a black outline. The entire logo is set against a background of a glowing blue and white light pattern.

LED照明展 LED Lighting Taiwan

The 5th Int'l LED Lighting Exposition
<http://www.optotaiwan.com>

June 11-13, 2009

TWTC Nangang
世貿南港展覽館

Exhibits

- **LED Lighting Fixture**
Indoor, Outdoor, Specialty
Decorating, Landscape, Architecture, Garden
Control System & Accessories
- **LED Applications**
Automotive Lamps, Backlight, Display Board, Traffic Signal, IrDA, etc.
- **Package / Module**
Lamp, Dot Matrix, Cluster, SMD, etc.
- **Epi Wafer, Chip**
- **Materials**
Substrate, Ingot, Phosphor, Lead Frame, etc.
- **Processing Equipment**
Wafer (MOCVD, Mask, Etching)
Assembly (Dicing, Bonding, Packaging)
Testing (Prober, Aging)

Organizer



財團法人光電科技工業協進會
Photonics Industry and Technology Development Association
台北市10093羅斯福路二段九號五樓
5F, No.9, Roosevelt Road, Sec.2, Taipei 10093, Taiwan
Tel: 886-2-2351-4026 Fax: 886-2-2396-8513

Simulation and Optimization of Optical Systems

> Dr. Norbert Harendt, Project Manager Illumination Design, IB/E OPTICS; Christoph Gerhard, Product Manager/Optics, LINOS Photonics

Due to the rapid further development, Light Emitting Diodes (LED) have become a well-established alternative to classic incandescent lamps. LED feature numerous advantages such as high luminous efficiency (up to 110 lm/W) and a high switching speed. Thus, LED can be used for a variety of applications, already replacing filament bulbs in headlights, operating mode displays and traffic lights. In addition, LED are used for lots of analytical and medical methods, varying from distance measurement to spectroscopy and polymerization of materials by UV irradiation. However, by reason of LED's directional characteristics, simulating and optimizing optical systems and illumination systems that contain LED light sources requires sophisticated design software. In this paper, we present the simulation and optimization of such an optical system. In this connection, the TracePro suite of optical and illumination design software was used in combination with the optimization tool OptiBelPro.

Simulation and Optimization Software

The design software TracePro is a versatile software tool for modeling the propagation of light in imaging and non-imaging opto-mechanical systems. The 3D models can be directly created or imported from a lens design or a CAD program. This makes it possible to design systems where optical elements can be extended to the very boundaries of the mechanical surroundings, as shown in Figure 1.

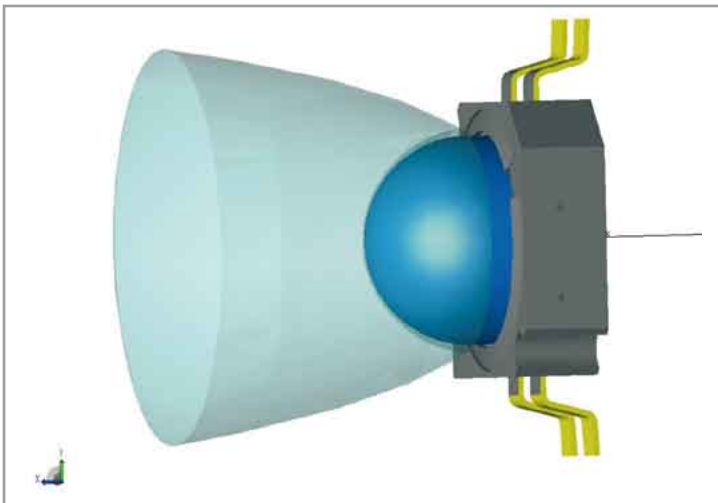

Figure 1: Representation of a LED Package with a TIR Lens in TracePro

These models can then be provided with different properties such as absorption, reflection and transmission, fluorescence and scatter. Furthermore, grid, surface and file sources can be modeled in this vein. For this purpose, measured data of particular LED can be imported and

applied to the solid model. In addition, the so-called Surface Source Property Utility [1] allows converting manufacturer's data sheets to light source properties by importing given values for spectral distribution and polar radiation pattern distribution, as shown in Figure 2.

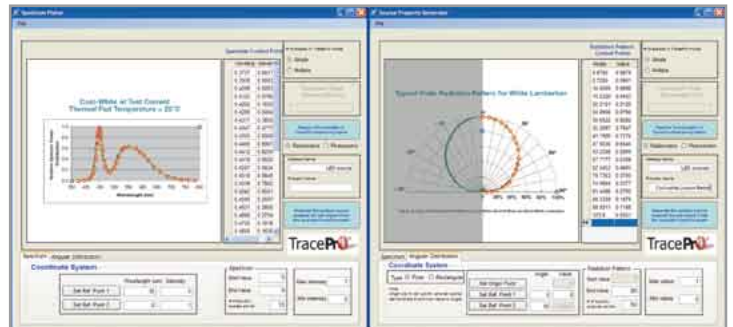

Figure 2: Surface Source Property Utility for importing spectral distribution and polar radiation pattern distribution

Hence, TracePro allows modeling and simulating optical systems containing LED and analyzing light distributions, stray light, scattered light and aperture diffraction, throughput, loss, system transmittance, flux or power absorbed by surfaces and bulk media, light scattering in biological tissue, fluorescence and birefringence effects of such systems.

To be suitable for illumination design on the other hand the design software has to provide automated system optimization, since illumination systems are usually designed to meet certain requirements. Maximized efficiency is one prominent example, maximized uniformity of irradiance distribution another one. Therefore OptiBelPro – the non-linear optimization module for TracePro – gives access to gradual modifications of the weightings between intensity and uniformity targeted optimization. Since OptiBelPro is tied to TracePro using its programming interface Scheme, the designer can implement every thinkable way of changing the model or calculation of merit value, which makes this tool extremely powerful.

Defining a Variety of Optimization Aims

The design of an illumination system with the highest possible efficiency in terms of maximized irradiance on the target surface is often one of the easy tasks. This allows reducing the number of rays to be used in simulation, which results in rather short optimization cycles. Switching to maximization of uniformity on the other hand results in optimizations with increased time consumption, since this involves calculation of a higher number of rays. The irradiance map of an illumination system designed for maximized efficiency (as illustrated in Figure 3) often lacks any uniformity, whereas maximized uniformity is often bound to poor efficiency.

Going from a single setting on intensity or uniformity weighting to a mixture of both, an increase in uniformity can be achieved with a gradually controllable loss in intensity, as shown in Figure 4.

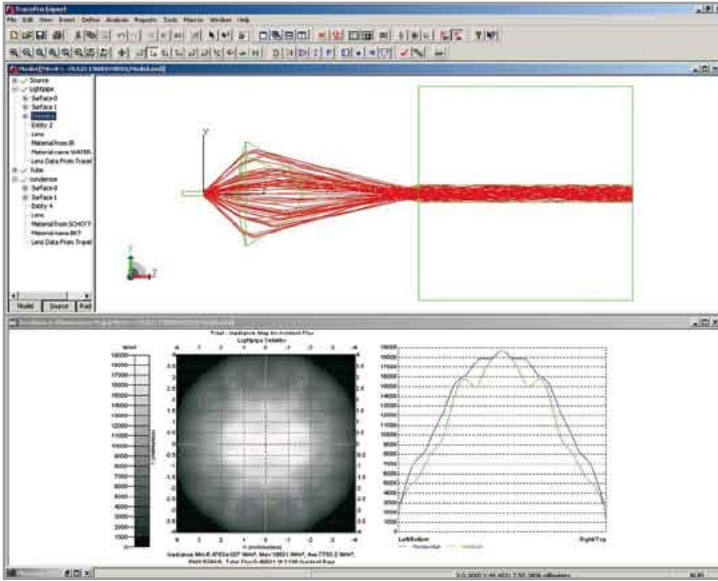

Figure 3: Example of a system optimized for maximum efficiency

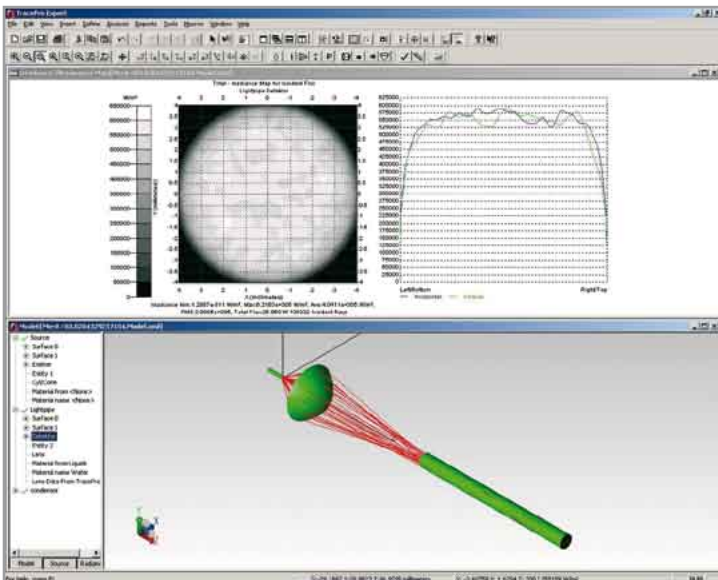

Figure 4: Result for Optimization on uniformity with slight respect to intensity added

The list of additional features contains freely definable model parameters together with optimization toggle and boundary settings, multiple target optimization, controlled interrupt and resume capabilities and comfortable logging abilities. Since the extension of the theoretically infinite list of model parameters may result in very long optimization cycles, one can have a set of intermediate models and irradiance maps saved to be reviewed without interruption of the optimization process.

Especially OptiBelPro's ability of multiple target optimization is an interesting feature for illumination designers, since this provides an easy approach to customized irradiance distributions. Figure 5 shows an example. Five target surfaces are configured in such a way that an optimization will produce a horizontal line of maximized intensity with vanishing intensity at the vertical axis. The modeling of more complex irradiance distributions is also possible

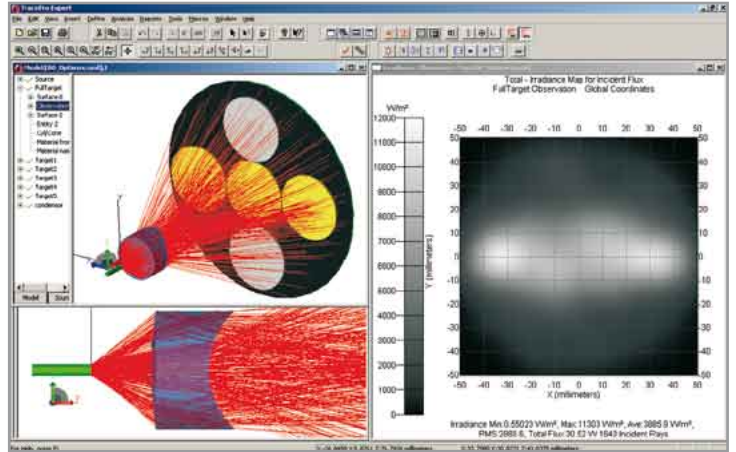

Figure 5: Example of multi target configuration setting up a horizontally line of irradiance

Practical Example: Zoom Lens Design

The design of a zoom lens for illumination purposes is an example of a task going far beyond simple analysis of intensity and/or uniformity on just one target surface. Because of the high luminous efficiency of LED they are prone for assembly of small lightweight illumination devices. Variable characteristic of light output is one of the prominent requirements targeted to such a device. Using TracePro and OptiBelPro this goal can be achieved with respect to the demands a customer will make on it.

Zoom lens design requires the possibility of simultaneously optimizing different configurations. With OptiBelPro it is possible to define multiple configurations in one model. A zoom lens, as shown in Figure 6, needs at least two different configurations: one representing the spot irradiation, which contributes to the merit value calculation by the total intensity achieved in a comparably small target area only. The wide angle configuration is characterized by a mixture of mainly uniformity weighting and a small intensity weighting for a large target area.

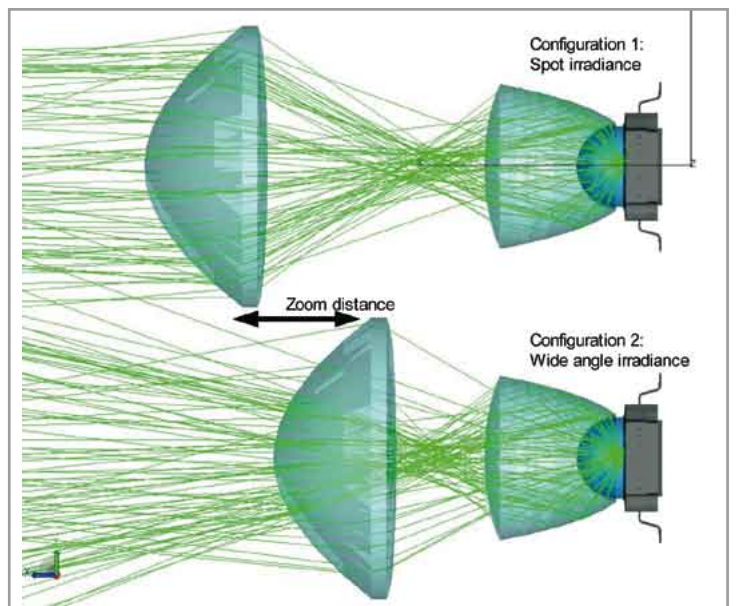

Figure 6: Example of two-element LED zoom configuration

Since production costs are often the main concern for such a system, a reasonable setup consists of one TIR lens in front of the LED and one focusing lens, which position can be varied in order to achieve the switch between spot and wide angle irradiation characteristic. Both lenses have to be made out of plastic, since this will provide the desired combination of low production costs and total aspherical surface design for all lenses involved.

Since non-linear optimization is an art, which can produce absurd results, one needs to have a good starting point, which means to start with a very limited set of model parameters, a weighting fixed to intensity maximization only and a profound idea of the most effective boundary conditions. Starting with just two plane sheets of plastic and a vast amount of model parameters had never lead to a good system design.

A reasonable starting point for the zoom lens delivered an optimized configuration with a zoom range between 9° and 35° illumination angle, an efficiency of 72% for the spot configuration and 82% for the wide angle configuration, as shown in the Figures 7 and 8.

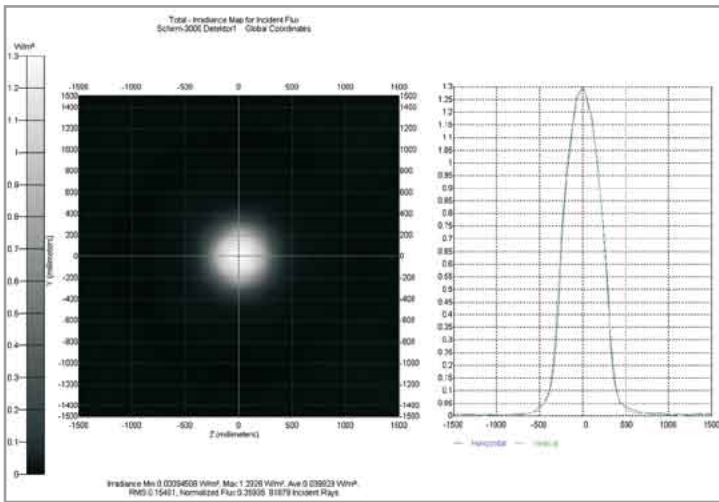

Figure 7: The irradiation map of spot configuration shows an efficiency of 72% and a viewing angle of 9°

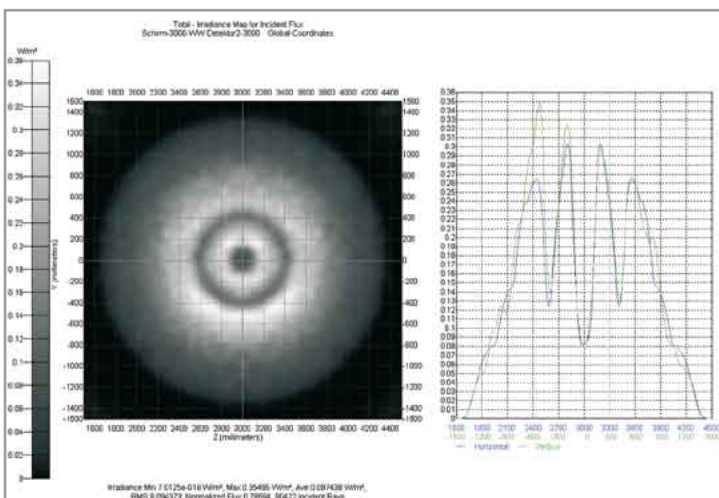

Figure 8: The first irradiation map of wide angle configuration shows an efficiency of 82% and a viewing angle of 35°

The uniformity of the wide angle configuration looks not optimal, since uniformity is often a trade-off between efficiency and uniformity. Using OptiBelPro's fine grained control to shift the weighting gaining more influence on uniformity a final configuration could be achieved. While leaving spot irradiance untouched uniformity for the wide angle configuration is increased with an efficiency reduction of 4% only. The most severe disturbances of uniformity, the center spot and ring, have vanished, as Figure 9 shows. Since the customer requested a smooth drop of irradiance at the edge of the irradiance map, the achieved configuration was acceptable. If a customized design task could cover an increase in system costs generated by a rising number of lenses and complexity of mechanics, the uniformity can surely be optimized even more by introducing additional lenses in the system.

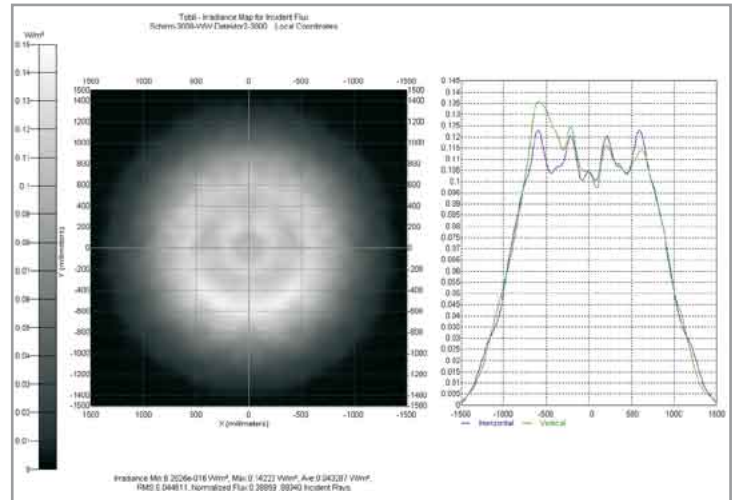

Figure 9: Optimized irradiation map of wide angle configuration shows an efficiency of 78% and a viewing angle of 35°

Conclusion

The combination of TracePro and OptiBelPro provides a mighty and flexible tool for every designer of opto mechanical illumination systems. The feature of automated system optimization saves time and effort in development and gains quality and compliance with the specifications. The possibility to fine grain the balance of intensity and uniformity weightings enables the designer to remain within the restrictions of the design specifications while extending the quality of the irradiance achieved. Limitations of the standard configuration can be pushed away since OptiBelPro allows for vast feature extension because of the mighty macro interface of TracePro. Finally, the ability to model actual LED packages either by real ray sets or by radiation distribution patterns provides even more advantages to an optical designer of LED based illumination systems. ■

References:

[1] "Model and Predict the Performance of LEDs for Solid State Lighting - Accurately and Quickly", Technical Note, Lambda Research Corporation 2007



LED CHINA 2009

— The Leading Global Event for LED Application

Time : February 28 to March 3, 2009

Venue : China Import and Export Fair Pazhou Complex, Second Phase (Guangzhou)

Please go to www.LEDChina-gz.com for more details.

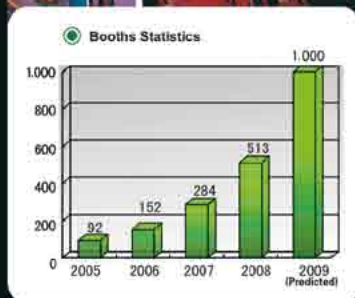

Analysis of LED CHINA (2005 - 2009)

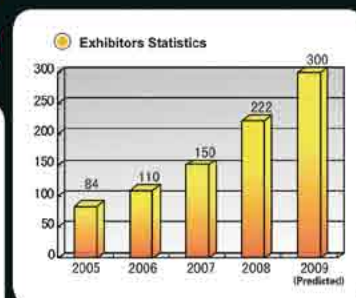
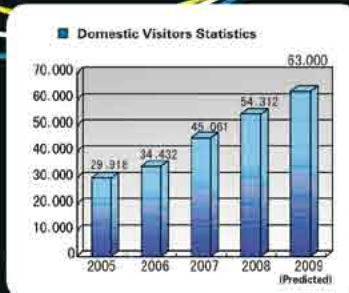
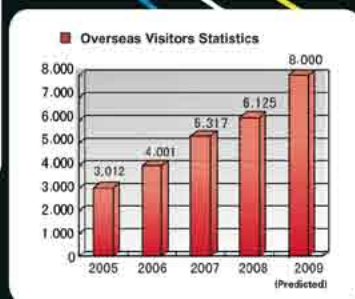

In 2009, the show anticipates gathering **300 exhibitors** taking up to **20,000 sq.m.** Exhibition space. **Don't miss it!**

Concurrent Activities

- LED Application Forum
- NEON SHOW 2009
- SIGN CHINA 2009

Entrance is free of charge. The online Visitor Pre-registration will start on October 13th, 2008. **Register now!**

Please contact us for details:
Trust Exhibition Co., Ltd.
 Tel: +86-20-3810 6261, 3810 6263
 Email: LED@TrustExhibition.com

Fax: +86-20-3810 6200
 Website: www.LEDChina-gz.com



Thermal Management

Simulating Device Thermal Performance Using PLECS

> Dr. John Schönberger, Plexim GmbH

In many industries, power electronic engineers face increased pressure to design converters that push the envelope in realms of efficiency, size and performance. For such highly-constrained applications, multidomain simulation tools are useful for taking into account factors such as thermal and EMI performance, which may impinge on the final design. One such simulation tool, PLECS, has inbuilt thermal domain modeling capabilities which permit the thermal behavior of a circuit to be simulated alongside the electrical circuit. In this article, the thermal modeling capabilities and simulation approach offered by PLECS will be explained. A case study, in which the temperature rise of a MOSFET in a flyback converter-based LED power supply is simulated, will be presented to demonstrate the application of the thermal modeling technique.

Thermal simulation using PLECS

PLECS is a circuit simulation toolbox for Simulink that is well suited for simulations of switching electrical systems that comprise both an electrical circuit and control system. The hallmark feature of PLECS is its use of ideal switches and its piecewise linear approach to solving switched electrical systems. Rather than simulating switching transitions using a small simulation time step and non-linear component models, PLECS uses ideal switching events. After each switching occurrence, PLECS immediately jumps to the new operating point by forming a new set of circuit equations. This approach permits the use of a larger time step and the simplification of component models. The end result is that electrical simulations are fast and robust. Although PLECS was originally designed as an electrical circuit simulator, its simulation capabilities have been extended to the thermal domain. One-dimensional modeling of thermal structures and simulation of thermal power flows is possible through the use of PLECS' thermal library.

A thermal simulation is created in PLECS by adding loss information to electrical component models and by defining the thermal network between the loss-producing components and the environment. The key component in the thermal network is the heatsink. Unique to PLECS, this component is a uniform temperature surface that is the link between the electrical and thermal domains. Losses from all components mounted on the heatsink are automatically injected into the thermal network.

Switching and conduction losses are defined for components by extending the standard electrical component models. Switching losses are defined by creating a 3-D lookup table in which the losses are defined as a function of junction temperature, blocking voltage and conducting current. The lookup tables are created by the user using an inbuilt visual editor. During a simulation, switching energy loss values are obtained from the lookup table after each switching instant. This

lookup table-based approach adopted by PLECS is much faster when compared with the alternative method of calculating the losses from the current and voltage waveforms across the device. The alternative approach requires detailed physical device models in conjunction with a small simulation time step, resulting in slow simulations.

Conduction losses are defined in a similar manner to switching losses. A 2-D lookup table is defined in which the forward voltage drop is characterized as a function of junction temperature and conducting current. During each simulation time step, the conduction loss is calculated by multiplying the device's forward voltage drop with the conducting current.

Switching frequency	42 kHz
Duty cycle	11 %
Transformer leakage inductance	2.06 mH
Input voltage	325 V
Load current	700 mA
Rth case-heatsink	23K/W

Table 1: Converter Parameters

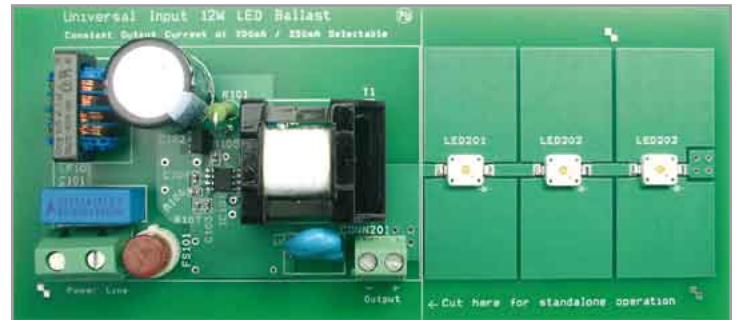

Figure 1: Flyback converter LED supply - Fairchild FEB228 evaluation board. Switching MOSFET is mounted underneath the PCB

During an electrical-thermal simulation, interaction occurs between the electrical and thermal domains. Component losses are computed in the electrical domain and the results are fed to the thermal circuit. With each update of the thermal circuit, the junction temperatures are fed to the electrical circuit in order to account for the temperature dependency of the component losses.

Case Study

To demonstrate the thermal modeling capabilities of PLECS, the temperature rise of the FCD4N60 MOSFET in a single-switch flyback converter for an LED supply was simulated. The results are compared with experimental measurements. The flyback converter, shown in Figure 1, converts a rectified 230 Vrms mains input into a constant DC current output of 700 mA for supplying a load of three series-connected LEDs. The converter parameters are shown in Table 1.

Simulation Model

The electrical simulation model is designed to replicate the conditions experienced by the MOSFET in the target circuit. The PLECS circuit schematic is shown in Figure 2 with the FCD4N60 MOSFET mounted on the heatsink in order to collect the conduction and switching losses.

Due to the static operating point of the converter, several simplifications were made to the electrical circuit. The input rectifier stage was replaced with a 325 V DC bus and the current control loop was omitted. The simulation model operates in open loop current control mode, regulating the peak voltage across the 1Ω current sense resistor to 0.4 V. It should be noted that the switching logic for the current controller is not shown in the circuit schematic because this is modeled in the Simulink worksheet that hosts the PLECS circuit.

To complete the simulation model, thermal loss information was added to the MOSFET. Lookup tables were added to the MOSFET model to account for the turn-on and turn-off losses. The loss values used, shown in Table 2, were obtained from experimental measurements taken at 27°C and 100°C. To obtain the measurements, the MOSFET was mounted on a separate heatsink with thermal glue. The thermal resistance of the heatsink structure was approximately 23 K/W.

Temperature	Turn on loss (μ)	Turn off loss (μ)
27°C	2.475	1.444
100°C	5.984	1.918

Table 2: Switching loss measurements for the FCD4N60 MOSFET

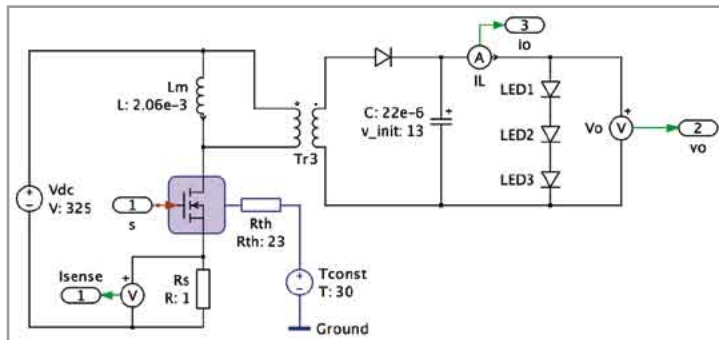

Figure 2: Combined electrical thermal simulation of a flyback converter using PLECS. The heatsink, shown in purple, automatically aggregates the MOSFET conduction and switching losses and injects the losses into the thermal circuit

Therefore the thermal impedance in the simulation model was set to this value. The thermal capacitance, not given in the heatsink datasheet, was assigned to a small value of 0.2 mJ/K in order to allow the heatsink and MOSFET temperatures to converge rapidly to their final values. In practice, the thermal capacitance would be larger but the actual value is unimportant since the purpose of the simulation is to obtain the final temperature differential.

The conduction losses were modeled by configuring the drain-source resistance of the MOSFET to an average value of 1Ω as recommended by the datasheet. The load, consisting of three Luxeon LXX2 1A LEDs, was modeled by adding a forward voltage drop and on resistance value to an ideal diode model. Each LED was assigned a forward voltage drop of 3.1 V and an on resistance of 0.6Ω such that the forward voltage drop at 1 A matches the typical datasheet value of 3.7 V.

Results

The results, which show the temperature rise of the MOSFET case compared with the ambient temperature, are given in Figure 3. The experimental results show that the case temperature at the beginning of the experiment is 27°C. The case temperature rises to 35°C by the end

of the experiment; however, the ambient temperature also rises by 3°C making the final temperature differential 5°C.

For the simulation results, the final ambient temperature of 30°C is used as the starting case temperature. At the end of the simulation run, the MOSFET case temperature is 34.3°C, or 4.3°C above the ambient temperature.

The simulation results show a good approximation of the experimental measurements. The temperature difference obtained with the simulation model is 4.3°C, or 14% lower than the experimental results. It should be noted that the temperature of the simulation model converged to its final value within 20 ms whereas the experimental system took approximately one minute to converge. The reason for this discrepancy is the thermal capacitance of the heatsink model was deliberately reduced in size to shorten the simulation time. If a more realistic value is needed to replicate the experimental system, it should be noted that PLECS includes a steady state analysis tool that iterates rapidly to the final steady state solution without wasting minutes or hours of simulation time.

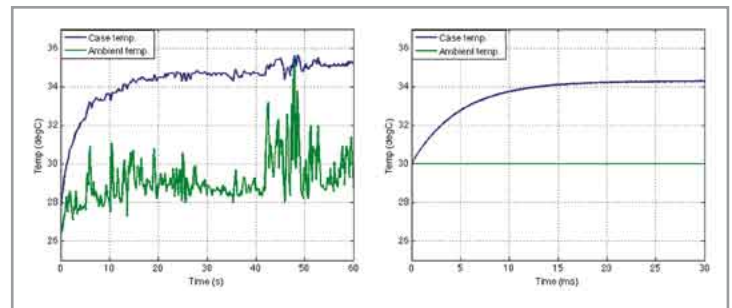

(a) Experimental results

(b) Simulation results

Figure 3: Experimental and simulation results showing the temperature rise of MOSFET case compared with the ambient temperature

Conclusion

This article has explained the principles of simulating combined electrical and thermal circuits using PLECS and has demonstrated the validity of the PLECS approach to this problem. PLECS uses a lookup tables to account for switching losses, simplifying the switching transitions and maintaining a fast simulation speed. The unique heatsink concept also permits simple coupling between the electrical and thermal domains.

As an example, a thermal model of a single MOSFET switch in a flyback converter was presented and the simulated increase in case temperature showed close correlation with actual experimental measurements.

More complicated thermal structures and circuits can be implemented using PLECS, including hierarchical component models and thermal circuits with multiple heat flow paths. One important point holds true regardless of the simulation complexity. The results are only as accurate as the data supplied and the validity of the electrical model. ■

Acknowledgements:

The author would like to thank Michael Weirich and Marcus Schmeidl from Fairchild Semiconductor Europe for supplying the MOSFET switching loss data and Siegfried Luger from Luger Research for his collaboration during the project.

Annual *LED professional Review (LpR)* Article Index 2008

Application

High Tech for Time Square's New Years Eve Ball by Jason Harris Koonce, e:cue Lighting Control	LpR05 - Jan/Feb 2008	p9
LED-Systems in Shoplighting by Andreas Siegmund, OSRAM GmbH	LpR06 - Mar/Apr 2008	p14
Interview with Jason Bruges - Jason Bruges Studio by Siegfried Luger, LED professional	LpR06 - Mar/Apr 2008	p15
Interview with Klaus Vamberszky - Zumtobel Lighting by Siegfried Luger, LED professional	LpR06 - Mar/Apr 2008	p16
Forethoughts on LED Breakouts in Signage by M. Nisa Khan, Ph.D., LED Lighting Technologies	LpR 07 - May/June 2008	p16
Integrated, Exergy-Efficient Office Solution Requires LED General Lighting by Dr. W. Werner, Dipl. Ing. F. Theßeling, Prof. Dr. H. Leibundgut, ETH Zürich	LpR 07 - May/June 2008	p18
City of Kelowna Goes Green with Solar-Powered Area Lighting by Anthony Tisot, Carmanah Technologies Corporation	LpR 08 - July/Aug 2008	p16
Solar LED Street Lighting by S. Block, OSRAM OS, G. Walch, F. Jungwirth, EPS soltec, and A. Grabher-Meyer, LED professional	LpR 08 - July/Aug 2008	p18
Progress in LED and OLED Display Technologies by M. Nisa Khan, Ph.D., LED Lighting Technologies	LpR 09 - Sept/Oct 2008	p14

Characterization

Visual Perception Issues of LED Applications by Ingrid M.L. Vogels, Pieter J.H. Seuntjens and Dragan Sekulovski, Philips Research Europe	LpR05 - Jan/Feb 2008	p12
Measurement of LEDs by Yoshi Ohno, Cameron Miller, and Yuqin Zong, National Institute of Standards and Technology	LpR05 - Jan/Feb 2008	p17
Integrating Sphere Applications for LED and Solar Cell Measurements by Sid Rane, SphereOptics	LpR 08 - July/Aug 2008	p24
Standards Set for Energy-Conserving LED Lighting NIST/DoE	LpR 08 - July/Aug 2008	p27
LED Lighting Technology Fundamentals and Measurement Guidelines by M. Nisa Khan, Ph.D., LED Lighting Technologies	LpR 10 - Nov/Dec 2008	p14
CIE 1964 Colorimetric Observer Chart Improves White Light Quality by Peter Pachlar, Tridonic Atco Optoelectronics	LpR 10 - Nov/Dec 2008	p16
White Light LEDs - Importance of Accepted Measurement Standards by Dr. Thomas Nägele; Instrument Systems GmbH	LpR 10 - Nov/Dec 2008	p22
The Role of Miniature Spectrometers in the LED Revolution by Jorge Macho, Ocean Optics	LpR 10 - Nov/Dec 2008	p26

Technology

High Performance Multi-Color LEDs in Chip-On-Board Technology by Oliver Kückmann and Jörg Hannig, PerkinElmer Elcos GmbH	LpR05 - Jan/Feb 2008	p22
White Light LED Technology with Increased Efficiency and Variable CCT by Erwin Baumgartner, Lumitech GmbH	LpR05 - Jan/Feb 2008	p26
LED Binning: A Process to Watch by Joe Mazzochette, Lamina	LpR05 - Jan/Feb 2008	p30
Discontent Led to Lumiramic Phosphor Technology by Steve Landau, Philips Lumileds	LpR05 - Mar/Apr 2008	p18
Improvements in Solid State Lighting III-V Semiconductor Production by Dr. Rainer Beccard, AIXTRON AG	LpR05 - Mar/Apr 2008	p20
Photonic-Lattice Technology by Christian Hoepfner, Luminus Devices	LpR 07 - May/June 2008	p20
Evolutionary LED Packaging for Increased Flux Density by Jason Posselt, LedEngin Inc.	LpR 07 - May/June 2008	p24
Nano-Patterned Sapphire Substrates Improve Performance of GaN-LEDs by Haiyong Gao, et al, Semiconductor Lighting Technology Res. and Dev. Center	LpR 08 - July/Aug 2008	p28
LED Efficacy: A Matter of Die Structures by Arno Grabher-Meyer, LED professional	LpR 08 - July/Aug 2008	p29

Increasing Light Extraction Efficiency of GaN LED Chips by Song, Mi Jeong, Ph.D.; Leniachine, V; Jeong Wook, Lee, Ph.D.; Samsung Research	LpR 08 - July/Aug 2008	p34
A Status on Solar Cell Technology by Anil Sethi, Flisom AG	LpR 08 - July/Aug 2008	p41
LED Encapsulant Epoxy Curing Optimization by Bit Tie Chan, Avago Technologies	LpR 10 - Nov/Dec 2008	p30
Optic		
Optics design for Colour Mixing LEDs by Dr. Andreas Timinger, OEC AG	LpR05 - Mar/Apr 2008	p24
Microstructured Optics for LED Applications by Arthur Davis, Reflexite Optical Solutions Business	LpR 09 - Sept/Oct 2008	p18
Review of SMS Design Methods and Real World Applications by Oliver Dross et al., Light Prescriptions Innovators LLC	LpR 09 - Sept/Oct 2008	p33
Plastic Optics Enable LED Lighting Revolution by Tomi Kuntze, LEDIL Oy	LpR 09 - Sept/Oct 2008	p41
LED Source Modeling Method Evaluations by Mark Jongewaard, LTI Optics and Kurt Wilcox, Ruud Lighting	LpR 10 - Nov/Dec 2008	p34
Simulation and Optimization of Optical Systems by Dr. Norbert Harendt, IB/E OPTICS and Christoph Gerhard, LINOS Photonics	LpR 10 - Nov/Dec 2008	p40
Driver		
High Efficiency 200W LED Ballast by Dr. Michael Weirich, Fairchild Semiconductor GmbH	LpR05 - Mar/Apr 2008	p28
Driving RGB High Power LEDs by Ulrich Kirchenberger and Pavel Koutensky, STMicroelectronics	LpR05 - Mar/Apr 2008	p32
High-Brightness-LED Control by Peter Green, International Rectifier	LpR05 - Mar/Apr 2008	p34
Parallel LED Luminous Flux Variation by Ed Wenzel, STMicroelectronics	LpR 07 - May/June 2008	p28
Low Noise in LED Driver Circuits by Roger Alm, Melexis	LpR 07 - May/June 2008	p30
Designing with High Efficient LED Driver for LED Lighting by Chih-Yu Wu, Macroblock	LpR 07 - May/June 2008	p33
Comparison Between Continuous (DC) and PWM LED Driving Modes by Laurent Massol, Arno Grabher-Meyer and Siegfried Luger, LED professional	LpR 07 - May/June 2008	p34
Solar Driven LED Systems by Peter B. Green, International Rectifier	LpR 08 - July/Aug 2008	p44
High Efficiency Power Supply for LED Street Lighting Illumination by Luca Salati, STMicroelectronics	LpR 08 - July/Aug 2008	p48
New Drive Circuit Supports Wide DC Input and Output Range by Bernie Weir, ON Semiconductor	LpR 09 - Sept/Oct 2008	p44
Simple and Accurate Constant Current Sensing for Non-Isolated LED Drivers by John S. Lo Giudice, STMicroelectronics	LpR 09 - Sept/Oct 2008	p47
Reliability Test of LED Driven by PWM Technique by B. J. Huang et al., National Taiwan University	LpR 09 - Sept/Oct 2008	p49
Module		
Improved LED Modules for General Lighting Market by Christoph Cox, VS-Optoelectronic	LpR05 - Mar/Apr 2008	p38
Thermal Management		
An In-Depth Look at Active Cooling Thermal Management: Synthetic Jet Technology by Mick Wilcox, Nuventix	LpR 07 - May/June 2008	p36
Simulating Device Thermal Performance Using PLECS by Dr. John Schönberger, Plexim GmbH	LpR 10 - Nov/Dec 2008	p44
Methodology		
TRIZ Introduction by Siegfried Luger, LED professional	LpR05 - Jan/Feb 2008	p33

"Showcase Your Products ..."

... and reach the decision makers and
industry leaders in LED lighting worldwide!

LED professional Review (LpR) Editorial Calendar 2009

Issue	Main Feature	Reservation by	Files by	Publication date
Jan/Feb	LED Electronics	Dec 23, 2008	Dec 31, 2008	Jan 30, 2009
Mar/Apr	LED Applications & Lighting Systems	Feb 20, 2009	Feb 27, 2009	Mar 31, 2009
May/June	LED Thermal Management	Apr 23, 2009	Apr 30, 2009	May 29, 2009
July/Aug	LED Light Generation	June 23, 2009	June 30, 2009	July 31, 2009
Sept/Oct	LED Primary & Secondary Optics	Aug 24, 2009	Aug 31, 2009	Sept 30, 2009
Nov/Dec	LED Testing, Simulation & Manufacturing Equipment	Oct 23, 2009	Oct 30, 2009	Nov 30, 2009

subscribe@info-led-professional.com

SUBSCRIBE

www.led-professional.com



Publisher

Luger Research
Institute for Innovation & Technology
dep LED professional
Rhomberts Fabrik
A 6850 Dornbirn, Austria | Europe
phone +43 5572 394 489
fax +43 5572 394 698
editors@led-professional.com

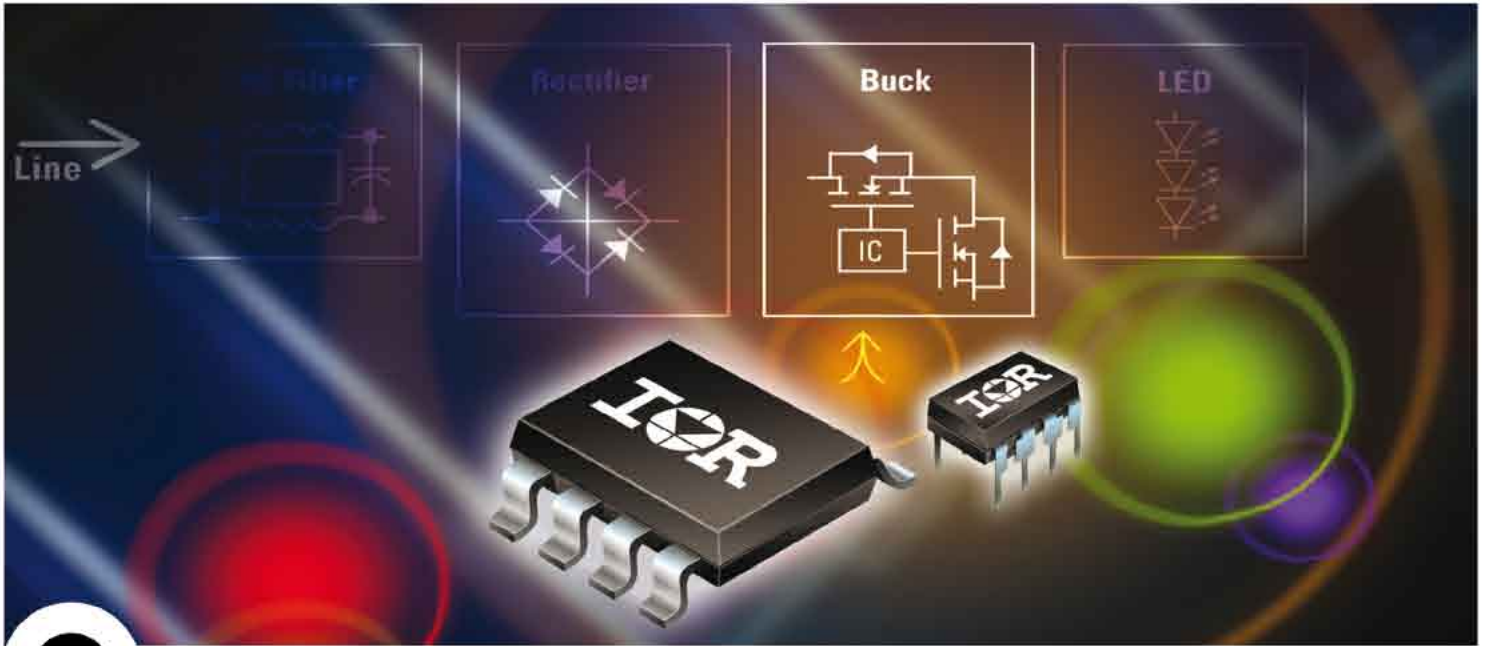

Precise, Reliable, High Brightness LED Driver ICs

For Constant LED Current Regulation

Part No.	Package	Voltage	Load Current Regulation	Micro-power Start-up	Deadtime	Frequency
IRS2540PbF	DIP8, S08	200V	+/-5%	<500 μ A	140ns	<500kHz
IRS2541PbF	DIP8, S08	600V	+/-5%	<500 μ A	140ns	<500kHz

IR's high-brightness LED driver IC's, adapt and compensate to LED parameter variations to enable a highly accurate and inherently stable design.

Features

- 200V or 600V control IC in compact 8-pin DIP or SO package
- Incorporates continuous mode, time-delayed hysteretic buck regulator
- External high-side bootstrap circuit delivers frequencies up to 500kHz
- Micro-power startup of less than 500 μ A
- 140ns deadtime for continuous current regulation
- Auto restart, non-latched shutdown and PWM dimmable capability

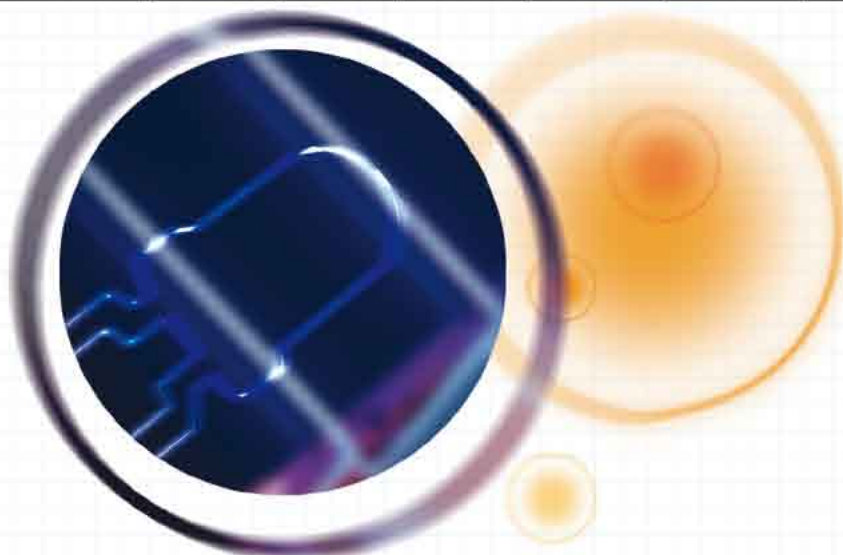

For more information call +33 (0) 1 64 86 49 53 or +49 (0) 6102 884 311

or visit us at <http://www.irf.com/lighting>

International
IOR Rectifier
THE POWER MANAGEMENT LEADER

TALEX

The next dimension in lighting technology.

www.tridonicatco.com



Seerestaurant Rorschach, Schweiz

High quality of light, high efficiency, more colour, greater dynamics – and all with exceptional economy. With TALEX from TridonicAtco you have greater control over light. For architecture and object lighting, for illuminated signage and emergency lighting, for traffic systems and for industrial applications. As a pioneer of chip-on-board technology and dynamic lighting, TridonicAtco has developed TALEX for maximum life and perfect output. See for yourself – at www.tridonicatco.com

a world of bright ideas®

TRIDONIC.ATCO

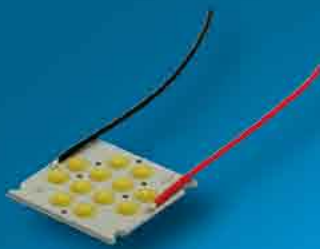

TALEXeos P216



TALEXengine



TALEXconverter



TALEXcontrols



TALEXprofile and TALEXlens



TALEXchain P515