

**LED**  
professional

[www.led-professional.com](http://www.led-professional.com)

ISSN 1993-890X

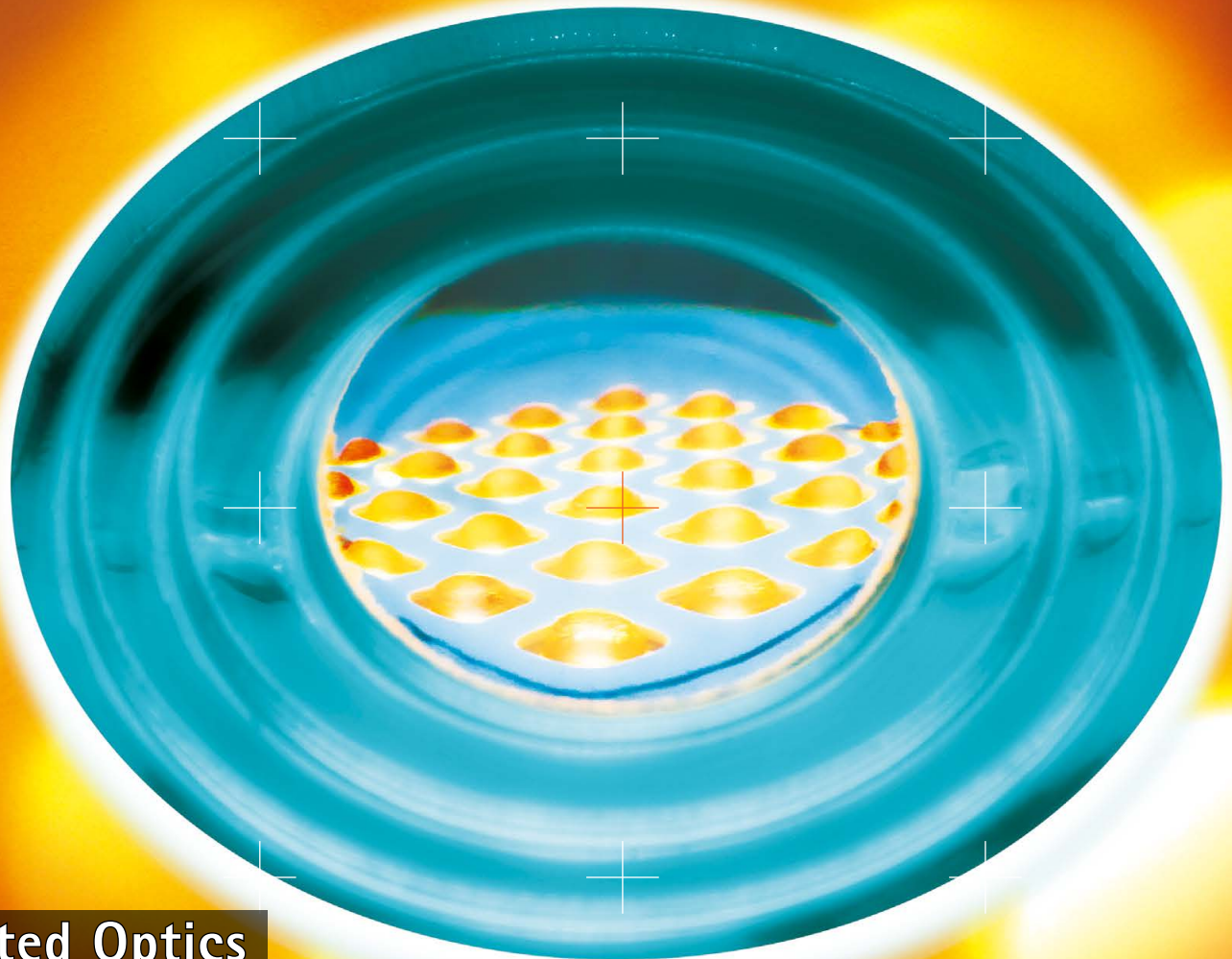
# Review

LpR

*The leading worldwide authority for LED & OLED lighting technology information*

Mar/Apr 2013 | Issue

**36**



**Printed Optics**

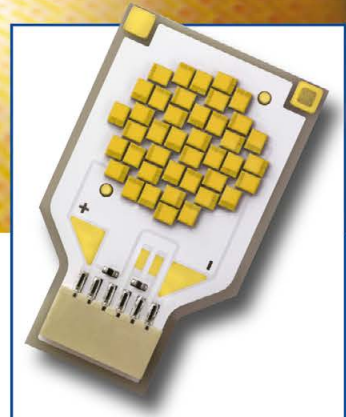
**LED Light Bulb Technology**

**Material Parameters of Optical Encapsulates**

**Emission Characteristic & Efficiency**



## Twice the light, half the size and all the sparkle. Brilliant.



When you need a brilliant light source that delivers maximum punch, adds richness with deeply saturated colors and crisp, defining shadows that make your subject sparkle. You need Philips Lumileds LUXEON® S high lumen density array. LUXEON S LEDs deliver the highest quality of light and industry-leading punch for high center beam intensity and uniformity and are ideal for retail, architectural and entertainment applications that require precise light beam control.

LUXEON S LEDs' unparalleled quality of light and efficacy rival and exceed that of Halogen and CDM lighting. Maximized flux density with a small optical source gives you extremely compact reflectors and intense narrow beam spots. The LUXEON S on-board connector and NTC, together with its 1000-8000 lumen packages, will simplify your design, reduce testing and get you to market faster.

[www.philipslumileds.com/LUXEONS](http://www.philipslumileds.com/LUXEONS)

**PHILIPS**  
**LUMILEDS**



## Challenge - Electronics

The change from traditional light sources to LEDs is, in many ways, a big step. Manufacturers have to adapt their product portfolio and lighting designers and installers have to figure out how the new light source will behave. A lot of research, studies and tests are being done to gain more knowledge when it comes to dealing with semiconductor light. By the end of this decade there will be significant improvements that are concentrated on the parameters and implementation of the LED.

This development is very important but the really big challenge, when looking at lighting installations in general, is ELECTRONICS.

The reason for this is that the weakest element in a system limits its overall performance. The life-time of electronic drivers is mainly determined by the use of electrolytic capacitors. The temperature degradation of these components will often reduce life-time under real conditions below the 50,000 hours that are expected of LEDs. In addition, the failure rates of the electronic modules, consisting of 50 to 100 single components, are not equal to the failure rates of single LEDs or LED strings.

Electronics are even being challenged on a system level. The number of electronic ballasts for fluorescent lamps that can be connected to a circuit breaker is well defined. The problem is that the inrush or start-up currents are much higher now and those limits don't correspond properly with the electronic LED drivers. Electronic ballasts demonstrate "soft" switch-on behaviour due to the filament heat up and ignition process – which takes up to one second. LEDs, on the other hand, can go from zero to full load immediately and the circuit breakers will fail.

There is a lot room for improvement when it comes to electronics for LEDs and OLEDs. We need long-lasting, high-performance electronics, which are adapted to the needs of the semiconductor light sources. This is true on both at component and system level.

Miniaturization is also very important. This is a requirement for improved form-factors and higher temperature robustness. "Driverless" is one way to go, but we have a lot of applications where specific drivers are also needed.

Electronics could end up being an important limiting factor for modern LED and OLED lighting systems. Although it is a big challenge, it is also a great opportunity for innovative future concepts.

Before closing, I would like to announce that a strategic cooperation has been made between Luger Research e.U./LED professional and Assodel/Tecnoimprese for providing extended services to you. Established in 1983, Assodel now has more than 200 members representing 95% of the component suppliers in Italy.

All the best and have a good read!

Yours Sincerely,

A handwritten signature in blue ink, appearing to be 'S. Luger', written over a horizontal line.

Siegfried Luger

Publisher, LED professional  
Event Director, LpS 2013

# Content

■ Editorial	p 1	COMMENTARY	p 4
Imprint	p 60	News - PROJECTS	p 6
		News - PRODUCTS	p 10
		News - RESEARCH	p 28

■ <b>STANDARDIZATION</b>	p 30
Labeling and Certification Testing Issues by Arno Grabher-Meyer, LED professional	

■ <b>INTERVIEW</b>	p 34
Optics Production Technology for Customizing LED Luminaires by Siegfried Luger & Arno Grabher-Meyer, LED professional	

■ <b>TECHNOLOGY</b>	p 40
How Silicones are Evolving to Meet the Growing Needs of the LED Lighting Industry by F. de Buyl, M. Beukema and K. van Tiggelen, Dow Corning	

■ <b>CHARACTERIZATION</b>	p 46
The Influence of LED Emission Characteristics on the Efficiency of Lighting Systems by Roland Schulz, Osram Opto Semiconductor	

■ <b>APPLICATION</b>	p 52
An Economical Omnidirectional A19 LED Light Bulb by Chen-Peng Hsu, Industrial Technology Research Institute (ITRI)	

## Advertising Index

Philips-Lumileds	C2
Epistar	p 3
Bicom Optics	p 5
Recom	p 7
Everlight	p 11
Honglitronic	p 13
dilitronics	p 15
China Int. Optoelectronic Expo	p 17
LedLink	p 19
StellarNet	p 21
Lambda Research	p 23
euroLED	p 25
Instrument Systems	p 27
Refond	p 29
Telcona	p 33
LightFair International	p 33
Lackwerke Peters	p 37
Recom	p 37
Intertek	p 39
Signcomplex	p 45
Edison Opto	p 49
LED Lighting Taiwan	p 49
LightFair International	p 51
Bodo's Power Systems	p 55
LED Expo Thailand	p 59
LpS 2013	C3
Future Lighting Solutions	C4



# EPISTAR

## Actualize LED Potential

### EPISTAR Chip Inside = Quality

[www.epistar.com](http://www.epistar.com)



Headquarters  
EPISTAR Corporation  
5 Li-hsin 5th Road, Hsinchu Science Park,  
Hsinchu 300, Taiwan  
T +886 3-567-8000 F +886 3-579-0801  
[sales@epistar.com.tw](mailto:sales@epistar.com.tw) [www.epistar.com](http://www.epistar.com)

China Sales Office  
Luxlite (Shenzhen) Corporation Limited.  
21F, Sunshine Golf Building, Shennan Road,  
Futian District Shenzhen 518040, China  
T +86 755-3335-5666 F +86 755-3335-5777  
[sales168@luxlite.cn](mailto:sales168@luxlite.cn) [www.luxlite.cn](http://www.luxlite.cn)



### Uwe Hock

Uwe Hock received his graduate engineer degree in electro technique / telecommunication from the University of Darmstadt in 1995. He joined Vestel Germany in 2012 with the focus on setting up and developing LED lighting business in Germany, Switzerland and Austria. Before that he worked at Sharp Microelectronics Europe for over 8 years; the last 4 as Manager of Lighting Business for Europe. His first LED related activities began at the end of 2007 in the areas of Sales & Marketing and Business Development for the emerging HB-LED market. Previous to that, he worked in the microelectronics industry for 10 years in various Sales & Marketing positions at companies like AT&T Microelectronics.

## WHAT IS THE NEXT WAVE IN LIGHTING – IS IT PURELY TECHNOLOGY?

Diversity makes lighting an exciting business. On the one hand you find people earning money with OLED doing one-off designs, then you have multi-billion Euro companies keeping their market share and reducing their workforce. How can this happen and what is next?

Looking at lighting through “semiconductor glasses” shows that the market needs to be faster, have extremely efficient “concept to production” cycles, as well as permanent cost reductions and increased flexibility by decreasing product lead-times, using platforms like Zhaga and managing stock efficiently.

This may work in B2B business for big complexes or factories with longer project lead-times, but it is almost impossible with regards to B2C business. Can an LED retrofit bulb be designed, qualified, produced and sold within a maximum of 6 months, in order not to become technically outdated? Maybe, but it also depends on attractiveness, price range and value to the customer as well as sales channels and market awareness. A delay factor could be the complexity of qualification and warranty and the fact that an LED is not only a component, but a complete system. As a result, very few companies can successfully produce LED bulbs for an extended period of time. Even the entry of Asian giants won't change things dramatically.

Most European lighting companies work in the B2B environment and don't have the capacity, resources or financial backing to take on things like designing or researching. They can't work within a 6-12 month development cycle, produce goods themselves, or wait for readymade products to be shipped from the Far East. They are repeatedly turning to lower cost European companies or EMS manufacturers for quick production.

In other high-tech businesses like TV or automotive, Eastern European countries like Poland and Turkey are expanding their concept from EMS to OEM. Especially Turkey, with its highly skilled work force, growing population and

stable, low salaries, has close relationships with many Western European countries!

A Turkish OEM electronics manufacturer, Vestel, with a turnover of over €5 billion has recently become the biggest producer of TVs for Europe. They have an annual capacity of 18 million pieces and an excellent reputation when it comes to quality and price. Just imagine: no tax and fast delivery times! This makes time to focus on core strengths like customer relations, product specification or market knowledge. Portfolios can be expanded quickly with ready-made, flexible luminaires that are custom made by a nearby manufacturer. Vestel and some other companies have started offering OEM services in the area of LED lighting.

From a technology point of view, I see an increase of innovations in area and linear lighting. Traditional ceiling tiles with T5/T8 tubes and traditional linear strip solutions will be replaced by flexible and fluid light. Point light sources like spot and track lights or downlights already achieve great color stability and uniformity with remote phosphor technologies. Ceiling lights are rather static and a 1 to 1 tube replacement remains a challenge, making little use of the technical advantages of semiconductor light. LED manufacturers should explore this market further while OLED need to improve in the areas of performance and lifetime while reducing costs to an acceptable level for mass markets.

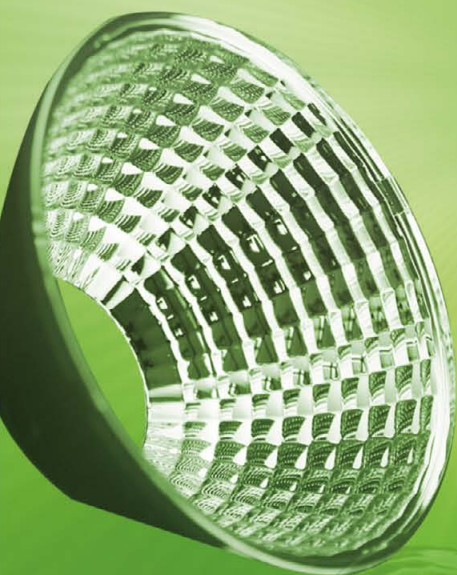
What is the next wave in lighting?

It may be production efficiency (see Lean Management in Automotive with increasing variations, higher automation, but smaller quantities or outsourced production). In the area of technology it will be new technologies in linear and area lighting (like OLED or flexible LED light solutions).

In the end, creativity and relationships decide who the market winners are. Fortunately, lighting is about emotions and people, not only money and technology. ■

U.H.

# Employing the latest in injection molding technology



Reflector



Multi lenses



Candle lamp lens

Come to us for the latest in high-end lenses. Our factory boasts cutting-edge injection technology – machines sourced from Toshiba and Fanuc in 2010. They allow us to make molds with temperature accuracy of  $\pm 0.5^{\circ}\text{C}$ . And our molds can be used over 600,000 times. Production is monitored by eight engineers with eight years of experience. Call us today to get started.

## **Bicom Optics**

Bldg. B4, Xinjianxing Industrial Park, Fengxin Rd.,  
Gongming, Shenzhen, Guangdong 518100, China

Tel: (86-755) 8203 3578 • Fax: (86-755) 8203 3711

E-mail: [sales@bicomoptics.com](mailto:sales@bicomoptics.com)

[www.bicomoptics.com](http://www.bicomoptics.com)

ISO 9001:2008   ISO 18001   ISO 14001   TS16949



# LED Hotel Lighting Saves \$138K a Year

Carved into a granite cliff in the North Okanagan in close proximity to Vernon, British Columbia, Sparkling Hill Resort is celebrated for its organic and modern flair—notably its creative use of \$10 million in Swarovski Crystal elements that provide an atmosphere of calm and serenity. Setting its sights on newly engaging, more energy-efficient LED hotel lighting, the European-influenced resort and wellness center recently specified 2,500 GE LED replacement lamps for its award-winning facility. The switch means an annual 828,000 kilowatt hours (kWhs) energy reduction at Sparkling Hill and will equate to \$1.3 million in total lighting cost savings over 10 years.



Carved into a granite cliff in British Columbia, Sparkling Hill Resort is celebrated for its modern flair and creative use of Swarovski Crystal

### A crystal clear choice:

Incorporated throughout Sparkling Hill, Swarovski Crystal creations - designed exclusively for Sparkling Hill by the famous Austrian crystal company - emulate the coolness of waterfalls and warmth of fireplaces, emanating light and vibrancy to spaces with their extraordinary brilliance, purity, and absolute precise cut. Optimizing this synergy of light, water and other decorative elements with the effects of new illumination was, according to chief engineer Wolfgang Hoppichler, the foremost concern of Swarovski Crystal.

Sparkling Hill engaged GE and Brite-Lite, a British Columbia-based lighting and electrical wholesaler, to better understand the best way to showcase the crystals. It was recommended that 50-watt halogen bulbs be changed to 7-watt PAR20 LED and 12-watt PAR30 LED replacement lamps -

products of GE ecomagination™ - in guest suites, penthouses and dining venues as well as meeting and activity rooms, among other areas, throughout the resort.

### Sparkling savings:

Following the installation of 2,200 PAR20 LED and 300 PAR30 LED replacement lamps, Sparkling Hill reduced its annual electricity use by 828,000 kWhs - a nearly \$66,300 hotel lighting cost savings based on an \$0.08 kWh rate and 24 hours of operation a day. Maintenance expense, meantime, has sharply fallen at the resort where staff had replaced 2,500 halogen bulbs a year on average.

“We were changing 10 to 20 bulbs every day just to keep up,” Hoppichler said. “Since the swap we’ve replaced only five LED lamps in less than two years.”

Including purchase, labor and disposal costs, Sparkling Hill is now spending \$68,000 less in annual upkeep thanks to longer-lived lighting technology. Totalling electricity, maintenance and related lighting expenses combined, operating costs have fallen by \$138,000 a year at the resort, or a projected \$1.3 million over 10 years.

### Rebates accelerate returns:

GE and Brite-Lite also helped Sparkling Hill fund its LED hotel lighting upgrade - guiding the resort to qualify for rebates from the local utility company for each LED lamp installed. Factoring for the purchase price of the new LED replacement lamps, project payback was achieved after only three months.

Sparkling Hill was named one of 11 “Trendsetting” hotels by Fodor’s Travel in its 2012 “Top 100 Hotels in the World” rankings. ■



After changing 10-20 halogen bulbs a day, during the past two years, Sparkling Hill has only had to replace five GE LED lamps



The LED lighting upgrade included new lamps in guest suites and penthouses



# LED



## SPECIFICATIONS:

- 3 WATT TO 150 WATT
- CONSTANT CURRENT AND CONSTANT VOLTAGE
- OUTPUT CURRENT FROM 350MA TO 8300MA
- OUTPUT VOLTAGE UP TO 56VOUT
- UNIVERSAL AC INPUTS (INCLUDING 277VAC)
- DIMMING AVAILABLE: TRIAC AND 0-10V
- EFFICIENCIES UP TO 91%
- WATERPROOF ENCLOSURE AVAILABLE (IP67)
- EXTENDED WARRANTY
- UL8750 CERTIFIED

[WWW.RECOM-LIGHTING.COM](http://WWW.RECOM-LIGHTING.COM)

# DRIVERS

**RECOM**  
LIGHTING

## Intelligent LED Illumination Concept for an Exclusive Room Atmosphere

dilitronics GmbH makes the rooms of the recently opened SCALA Turm Hotel (a 4-star hotel) shine dazzlingly: The experts of the high-tech company in Jena, Germany developed a sophisticated illumination concept for the second tallest hotel in Germany based completely on LED technique and digital control components. Light stripes integrated into ceilings and walls can produce a broad color spectrum, allowing for room atmospheres according to one's individual wishes. By implementing the dilitronics company's complete package, which includes drivers for dimming and controlling the colors as well as the power supply units and luminaires, the SCALA Turm Hotel can count on a modern and, at the same time, energy-saving system of illumination.

Light plays an important role in the SCALA Turm Hotel: Due to the almost complete glass construction of the exterior walls and of the transparent walls of the bathrooms within the individual hotel rooms, the rooms are flooded with light.

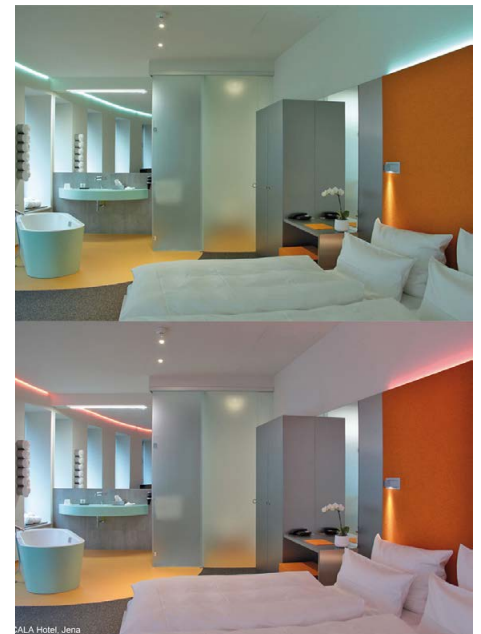
The complete illumination is controlled by Digital Addressable Lighting Interfaces (DALI). The respective DALI components allow individual light intensities and atmospheres to be saved and activated. Thanks to the efficient controlling abilities of the LED luminaires, the DALI systems made by dilitronics can also offer an enormously high energy-saving potential.



**Stylish and bright rooms are the result of the new lighting concept of the SCALA Turm Hotel**

Due to its intelligent illumination concept, dilitronics creates an impressive spatial experience. Rooms as well as corridors can be immersed in numerous RGB light scenes that are selectable according to one's individual preferences and current light conditions. A special highlight is the simulation of a sunset mood in the exclusive junior suite called the "Aqua Large-Room". The cozy atmosphere can be particularly enjoyed in the free-standing bathtub.

Due to the well-conceived use of an intelligent LED illumination system, dilitronics has successfully managed to create natural lighting conditions completely in keeping with the architectural concept. At the same time, the innovative technique is masterfully hidden in the background, allowing for the showcasing of an airy and floating room atmosphere. ■



**LED lighting allows for change in the appearance of the luxury suites of the SCALA Turm Hotel**



**The new LED lights emphasize the atmosphere in the SCALA restaurant with its breathtaking view**

## Contemporary Lighting Art by Zumtobel

After having been closed for more than 10 years, the *Kunstkammer* was presented to the public again on March 1, with the explicit goal of making the history of the Habsburg collection and its most important figureheads known to an interested contemporary audience. The highest conservation requirements, content-related didactic criteria, but also emotional factors played an equally essential role for the new presentation of the *Kunstkammer*. Yet, the 2,200 exhibits included in the collection could not be more different in nature: among the highlights are outstanding works of the goldsmith's art, such as the famous *Saliera* by Benvenuto Cellini, first-rate specimens of sculpture, such as the *Krumau Madonna*, masterly bronze statuettes, filigree ivory objects, but also precious clocks, games and scientific instruments.

Zumtobel has developed a customised LED lighting solution in order to obtain a highly differentiated, gentle and effective illumination of the various objects on display. "The point was literally to present the objects in the best possible light. All exhibits are originals, and each of them has its very special aura that we want visitors to be able to feel and experience," says Sabine Haag, General Director of the *Kunsthistorisches Museum*.



**With the Starbrick, Zumtobel was able to make an essential contribution ensuring the state-of-the-art presentation of this unique collection by providing a very special lighting solution**



**One of Austria's most important cultural projects is the reopening of the *Kunstkammer* (Chamber of Art and Natural Wonders) in Vienna**

At the heart of the lighting solution is the *Starbrick*, a Zumtobel Masterpiece developed in collaboration with Danish-Icelandic artist Olafur Eliasson. Boasting unpretentious elegance and multi-functionality, the *Starbrick* is the only representative of contemporary art and cutting-edge technology in these rooms of the museum that were opened for the first time in 1891. The installation includes a total of 51 *Starbrick* assemblies consisting of four modules each, especially designed for illuminating the unique and sensitive works of art. Additional direct light is ensured by integrated *Supersystem* spotlights and indirect light is provided by a *Panos Infinity* module, while one of the *Starbrick's* surfaces that is directed downwards doubles as emergency lighting. "Due to the height of the ceiling, we had to increase the levels of light intensity, but the original shape of the *Starbrick* remained unchanged. Taking the historical rooms into particular consideration, a highly specific *Starbrick* assembly was created, so that the modules work like a picture, like stars in the sky," explains Olafur Eliasson.

In addition to LED *Supersystem* spotlights mounted on the walls, single *Supersystem* spotlights were also installed in the showcases. Especially in the showcases, each of them a highly sensitive closed system, the benefits of LED technology can be fully exploited. Thus, light-emitting diodes not only

boast a long service life and high energy efficiency, combined with reduced maintenance cost, but also ensure an effective and at the same time gentle presentation of the exhibits. Moreover, the light colors can be individually matched to the colors and materials of the exhibits, so that they can unfurl their full charm and allow visitors to experience them authentically.

"Illuminating this significant and unique collection in a contemporary way has been a special project for us. In collaboration with architects, designers and Olafur Eliasson we managed to develop a lighting solution that is in line with the new concept of the *Kunstkammer*, meeting the most demanding conservation requirements and providing the best light for an unrestricted enjoyment of art," says Reinhardt Wurzer, Director International Projects, Zumtobel Lighting.

### About the *Starbrick*:

Four individual works of lighting art, the Masterpieces, have been created in close cooperation between Zumtobel and international architects, designers and artists. The *Starbrick* is a versatile lighting module. Its basic structure is a cube, on whose six surfaces additional cubes have been placed at an angle of 45°. These additional cubes serve as connectors to combine several *Starbrick* modules. ■

## LUXEON S - Highest Lumen Density and Best Center Beam Candle Power

Philips Lumileds introduced LUXEON S, its second generation illumination-grade multichip emitters which offer twice the lumen density of existing solutions - an R9 value that exceeds 80 and has 50 percent better Color over Angle variation over existing solutions.



**Delivering over 50 lumens per square millimeter, Philips Lumileds' new offer enables faster design of luminaires with on-board connector, NTC, and 1000-8000 lumen output**

Because of the challenges in creating a small footprint with tight beam angles and high lumen density, luminaire designers have had to deal with large optics and limited lumen levels. With LUXEON S, luminaire designers have more flexibility and can achieve beam angles in the 8 degree range in a compact design, with light levels that rival traditional CDM light sources. This flexibility enables never-before-possible Center Beam Candle Power (CBCP) of over 50,000 candela.

"With a lumen density that is twice that of available solutions, the LUXEON S can offer light outputs as high as 8000 lumens at half of the optical size, enabling LED approaches to replace traditional ceramic discharge metal-halide (CDM) lamps in spotlight and architectural applications," said Orson Lo, Director of LUXEON S products for Philips Lumileds. "Relative to CDM lamps, LUXEON S-based lamps offer comparable efficacy of 90 lm/W but with instant-on operation, better color consistency and four times the expected lifetime at 60,000 hours."

The new emitters feature correlated color temperatures of 2700 K and 3000 K with a CRI of 80 or 90, as well as CCTs of 3500 K, 4000 K and 5000 K at CRI of 80. In the 90 CRI products, R9 value exceeds 80, making them ideal for applications requiring exceptional color renderings. ■

## Edison Opto's New EdiPower II HM and CA Series Exert the Advantages of COB

In view of the market trends, the Taiwanese leading LED lighting manufacturer, Edison Opto, launched all series COB products, such as 7~35 Watt high efficacy EdiPower II HR series and 3.5~30 Watt high brightness HS series in 2012. They also recently unveiled the EdiPower II HM series and CA series for different operating powers and different colors.



< EdiPower II HM



EdiPower II CA >

**While the HM series is based on a mirror-like MCPCB, the CA series is based on a ceramic substrate**

The 9~60 Watt EdiPower II HM series is based on the mirror-like MCPCB which features excellent reflectivity and luminous efficacy. Under 700 mA, it can reach 3200 lm in cool white (equivalent to 126 lm/W). In addition, Edison Opto's 3.5~7 Watt EdiPower II CA series is based on the ceramic substrate which can provide better thermal dissipation performance. Under 4 Watt (200 mA), EdiPower II CA series can reach 385 lm in warm white with CRI 80. Because the mirror-like MCPCB and ceramic substrate both contain no silver, EdiPower II HM series and CA series can free from the appearance of sulfuration. Consequently, it increases the reliability of EdiPower II HM and CA series.

The high performance COB products can be applied in many fields such as LEDs light bulb, down lights, track lights, residential lighting and commercial lighting fixtures. Last year, Edison Opto introduced many high lm/\$, high efficacy and more energy-efficient products. Looking into 2013, Edison Opto will continue its innovative spirit to develop new products which can satisfy the market demands. ■

## Sharp's New Mini ZENIGATA LEDs with a Round Light Emitting Surface

Compared to previous models the round form of the light emitting surface (LES) of the new product generation of Sharp's Mini ZENIGATA LEDs is new. Due to their circular LES, modules of type GW6BxxxxHED have qualities similar to a high-performance point light source. In contrast to earlier models and to conventional multipoint light sources, they require simpler optics. The narrow dimensions combined with the small, round LES enable a high degree of flexibility in design even for compact lights with an extremely narrow dispersion angle, as is especially required for down-lights / spotlights.



**Sharp's new Mini ZENIGATA is set apart by its round light emitting surface that simplifies the optical design of lights**

The base for the new Mini ZENIGATA LEDs continues to be a substrate of technical ceramic (Aluminium oxide Al<sub>2</sub>O<sub>3</sub>) with dimensions of 15 mm x 12 mm x 1.6 mm. Mechanically, the new modules are fully compatible - not only with earlier models but also within the different performance classes. As a result, they can be easily integrated into existing designs, and luminaire manufacturers are able to develop luminaire series with the same lighting housing in different performance- and brightness classes based on the new Mini ZENIGATA COB LEDs.

The new generation includes five different series: the 6 W, 7 W, 9 W, 12 W and 15 W. The different series differs concerning forward voltage and current. The 12 W version is available in two configurations: One driven with a forward current of 320 mA at 36 V and the other with a current of 640 mA at 18 V.

The color temperatures of the new white light LED arrays are within the 2,700 to 5,000 Kelvin range. ■



#### 45-21S Series (3020)

- Package: 0.2W PLCC-3
- Efficacy: >113lm/W (3000K CCT)
- CRI: >80
- Thermal Resistance: 50°C/W



#### 62-217D Series (5630)

- Package : 0.5W PLCC-2
- Efficacy : >93lm/W (3000K CCT)
- CRI : >80
- Thermal Resistance : 22°C/W



#### XI3535 Series (3535)

- Package : 1.0W EMC
- Efficacy : >105lm/W (3000K CCT)
- CRI : >80
- Thermal Resistance : 20°C/W



Structures and materials depend on demand of client.



## The Right LED for The Right Application



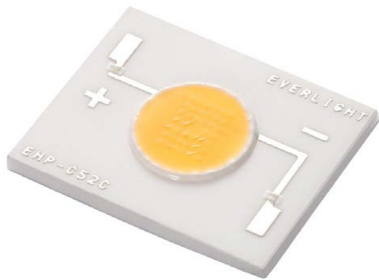
EVERLIGHT 3020S 0.2W, 5630D 0.5W and XI3535 1.0W LEDs are your new choices for indoor lighting applications. They offer highly competitive cost versus performance, new lead frame technology, and LM80 testing to match all your needs with different package sizes and power consumptions. EVERLIGHT offers a total solution to fulfill all demands with "The Right LED for the Right Application".

For more information, please visit: [www.everlight.com](http://www.everlight.com)

# EVERLIGHT

## Everlight Announces New Series of LED Components

At Lighting Japan 2013, Everlight showcased their most updated and brand new series of high efficiency and brightness LED packages for general lighting, automotive and iR sensor applications. Everlight brought up the concept of "The Right LED for the Right Application," in order to provide the best performance and quality for different applications.



Besides the COB LED series, Everlight showed new compact sizes of 2323 and 3535 type, Ju Series and a 3020S series of LEDs

For general lighting applications such as A60 light bulbs, directional and Omni-directional lights, PAR lights, candle lights, light tubes etc., Everlight represents the most updated series of highly efficient LED lighting packages including the new 3020S series. The high brightness PLCC packages can be driven up to 30mA or 60mA, new compact sizes of 2323 and 3535 series with high brightness and Ju Series, the COB LED series with multiple sizes and power consumptions. At Everlight users can easily find the most suitable LED for their fixture designs. Moreover, Everlight's High, Mid/Low Power LED and COB LED packages has adopted the LM80 test. Furthermore, Everlight also unveiled their powerful, bright and economic (superb \$/lm) LED series in a compact package. ■

## Philips Sets New Mid-Power LED Standard with LUXEON 3535L

Philips Lumileds' LUXEON 3535L family of mid-power LEDs offers 165 lm/W at cool white and 150 lm/W at warm white, the highest efficacy available for the category on the market. The LUXEON 3535L supports ENERGY STAR® certification requirements.



**Philips Lumileds' new LUXEON 3535L claims to have the highest efficiency in its class**

"Our LUXEON 3535L mid-power LED offers luminaire and lamp manufacturers unique flexibility by combining industry-leading efficacy and lumen maintenance with a wide range of CCTs and CRIs to help them achieve the right light quality for their application. The ability of the LUXEON 3535L to meet ENERGY STAR® requirements at 105°C and 150mA puts it ahead of all competitive parts in the market," said Khim Lee, director of mid-power products at Philips Lumileds.

To provide lamp and luminaire manufacturers with maximum flexibility, LUXEON 3535L mid-power LEDs are available across a full range of CCT (2700 K – 6500 K) and CRI (70, 80 and 90 CRI) combinations. The LUXEON 3535L is already being widely used in retrofit A19 bulbs, TLEDs, and several office, indoor area lighting and retail applications. ■

## Sharp EU Presents New Mega ZENIGATA LEDs with 108 lm/W

The newest generation of Mega ZENIGATA LEDs from Sharp shines with a luminous efficiency of up to 108 lm/W in standard use. The new LED arrays are available in four different performance classes: 15 W, 25 W, 35 W and 50 W.



**Sharp's new Mega ZENIGATA series features increased efficiency of up to 108 lm/W and increased luminous flux up of to 4780 lm**

The 50 W arrays require a forward voltage of 50 V and are designed for a constant current of 950 mA. In this way, they achieve a luminous flux of up to 4780 lm. With increased energy input of up to 1500 mA, the brightness of the 50 W COB LED may be trimmed to 6930 lm.

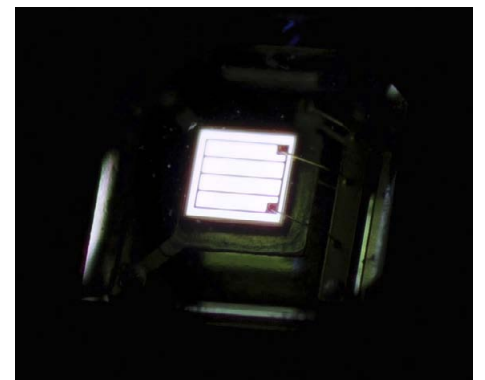
The smaller siblings are specified for a forward current of 400 mA, 700 mA and 950 mA, respectively, with a forward voltage of 37 V and thereby achieve a luminous flux of 1600 lm, 2700 lm and 3600 lm respectively. The forward current input may be increased, allowing maximum brightness of 2480 lm to be obtained with the 15 W series, 3780 lm with the 25 W series and 4680 lm with the 35 W series.

Sharp's Mega ZENIGATA LEDs continue to be based on a thermally highly conductive substrate from technical ceramics (Aluminium oxide Al<sub>2</sub>O<sub>3</sub>) with dimensions of 24 mm x 20 mm x 1.8 mm and a round light emitting surface (LES) with a diameter of 17 mm.

Overall, the MegaZENI LED COB LEDs are characterized by high light quality and high performance in a compact form. ■

## SemiLEDs Announces EV-LED Family with Improved Efficiency

SemiLEDs announced its recent improvements in both epitaxial quality and chip process to its EV family of LED chips. These improvements allowed a 10% increase in blue chip brightness and 8% decrease in forward voltage (Vf) during mass production, enabling its clients to achieve over 130 lm/W with cool white and 110 lm/W with warm white at 350 mA.



**SemiLEDs improved efficiency and power capabilities of the EV LED product family which was released in June 2012**

With Enhanced Vertical (EV) technology, SemiLEDs was able to increase brightness and lower defects with its new advancements in Epitaxial and Process Technology. Production monitoring showed an increase of 10% in the brightness distribution and improved leakage current yield. The EV technology not only increased the luminous output, but it also enabled a down shift of Vf, increasing the efficiency by 6–8% at 350 mA.

“We are excited about the improvement. Our RD efforts have paid off to further strengthen SemiLEDs position in the LED market” said Trung Doan, Chairman and CEO of SemiLEDs.

These improvements make SemiLEDs chips suitable for demanding directional applications such as street lighting, tunnel lighting and indoor retail lighting. ■

## A Breakthrough in the World of OLEDs - Tridonic LUREON REP

At the beginning of 2013, Tridonic landed a big breakthrough with OLED modules for professional lighting. Available in series, the new lighting module from the OLED module LUREON REP product range achieves a luminous flux of more than 100 lumens, at dimensions of 99 x 99 mm<sup>2</sup> for the first time. In addition, LUREON REP achieves a system efficiency of over 50 lm/W in neutral white.



**At 4000 K, LUREON REP achieves over 50 lm/W and more than 100 lumens, at dimensions of 99 x 99 mm<sup>2</sup>**

The square OLED module LUREON REP module will be available from mid-March with a color temperature of 4,000 K, featuring extremely high levels of luminous emittance (up to 12,000 lm/m<sup>2</sup>) and luminance (4,000 cd/m<sup>2</sup>). It goes without saying that the new modules are also incorporated into Tridonic's converter solutions.

**Use in professional lighting applications:** “With LUREON REP we managed to achieve a major breakthrough in the world of OLEDs. A new performance category of OLEDs has been defined at more than 50 lm/W and high brightness levels, so that now we are able to implement professional lighting applications for the first time,” explains Jörg Amelung, Managing Director of Tridonic's OLED division. Moreover, excellent color rendering (CRI > 80), an extremely low color angle shift ( $x, y \leq 0.005$ ) and low color tolerance (MacAdam 4) add up to establishing the OLED lighting module also on the professional market. Due to a module thickness of less than 3 mm, the OLED module is ideal for use in free-standing and pendant luminaires. ■

## Xicato's XSM 3000 LED Module - More Efficient and Brighter

Xicato, a leading developer of LED modules for retail, hospitality and architectural environments, recently announced the latest addition to its XSM family of products. A 3,000 lumen module that is easily implemented into new or existing spot and general illumination applications. In addition to retaining Xicato's quality of light characteristics, all XSM products share a common footprint, mechanical connections and optical aperture, so it's easy for lighting manufacturers to offer a portfolio of solutions by simply changing modules. There's no need to re-engineer reflectors or fit to expand a range of luminaires. The new XSM module is designed to replace a 35 W ceramic metal halide lamp and deliver superior color consistency initially and over time.

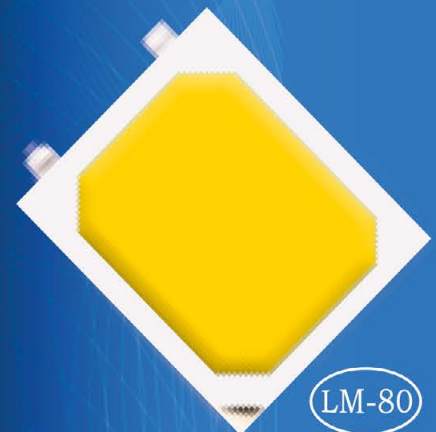


**Xicato's new XSM module offers increased efficacy and is designed to replace a 35W ceramic metal halide lamps**

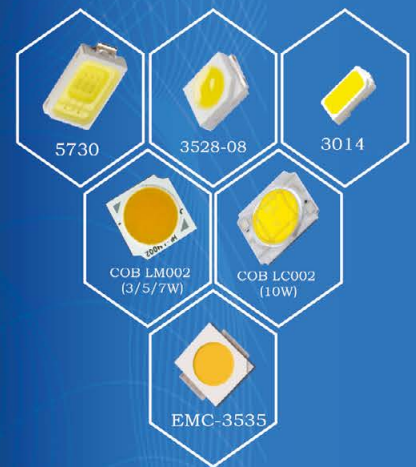
## First Choice for Light

Approved IES LM-80 6,000-hour test

➤ **Exhibition: LED CHINA 2013.**  
1-4 Mar. 2013, hall 10.3-C02.



2835



Guangzhou Hongli Opto-Electronic Co., Ltd.

Address: Airport High-Tech Industrial Zone,  
Jingu South Road (Intersection of Xianke 1st  
Rd), Huadong Town, Huadu Dist.,  
Guangzhou, China

Tel: +86-20-8673 3333 ext 3033

Fax: +86-20-8673 3883

E-mail: sales@honglitrionic.com

www.honglitrionic.com

Become our distributor, your right choice.



**HONGLITRONIC**  
鸿利光电

The Leading Manufacturer of White Light LED in China.

“The new XSM module uses our phosphor and packaging innovations to achieve great efficiency that supports energy and cost reductions while retaining ease-of-use for our OEMs,” said Thor Scordelis, manager of global product marketing at Xicato. “XSM 3000 does this without sacrificing quality of light or the “future-proof” approach of our product family.” ■

## Carclo Offers Light Engine for Street Lighting Application

The S class street lighting module is the first product in a line of full LED solutions to be launched in the Carclo LED light engines range. It is the direct result of market demand for LED lighting systems that allow our end customers to specify Carclo optics designs without the need for bespoke development of the associated electronics, thermal and mechanical systems.



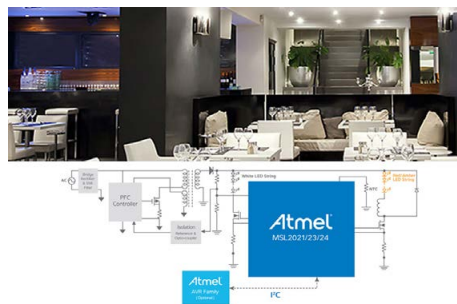
**Carclo takes the first step towards going from an optics manufacturer to an integrated LED module manufacturer**

The module uses the Carclo S class free-form optic combined with high efficiency and high output LEDs in a fully sealed and thermally optimized assembly. The module has been developed and tested by the Carclo group company Wipac Ltd, who has over 10 years of experience in the design and supply of high power LED lighting systems to the European automotive industry. This expertise has allowed us to create a product that sets new standards for full system efficiency, build quality and reliability.

Alongside market leading product quality, we are also committed to providing accurate “real-world” performance data to ensure the installed performance, energy savings and lifetime of our products fully meet customer expectations. ■

## Unique Two-channel LED Drivers for High CRI Professional and Consumer Lamps

Atmel® Corp., a leader in microcontroller (MCU) and touch solutions, announced three new two-channel solid state lighting (SSL) LED drivers that provide accurate color control for two-color LED light engines. In addition, the LED drivers deliver the most efficient power management, with the lowest component count, for high CRI LED lamps.



**MSL2021/23/24 devices deliver high light quality for warm white high color rendering index (CRI) LED lamps with industry’s most efficient power management and lowest component count**

Ideal for applications including general lighting, residential and commercial lighting, architectural lighting, and mood lighting, LED drivers consist of the Atmel MSL2021, MSL2023, MSL2024; all can be accompanied with an Atmel AVR microcontroller (MCU) or ARM processor-based MCU for a complete system solution in a variety of luminaires and lamp configurations.

**The new MSL2021/23/24 LED devices have several distinct advantages when compared to existing LED drivers:**

The devices drive one dominant LED string with a linear controller and one color LED string with a low-side buck controller to achieve the target CCT coordinate, and replicate the color spectrum to attain a high CRI. The devices have a look-up table in the EEPROM so designers can program accurate profiles to follow a desired CCT compensation curve, lowering the overall bill of materials cost. The linear controller for white LEDs in the device family adaptively controls the headroom of any AC/DC or DC/DC, isolated or non-isolated topology, while external MOSFETs give designers the flexibility of choosing LED currents and LED string lengths. In addition, there are several dimming options and I2C interface for additional flexibility and control. ■

## Commercial Lighting and Wireless Lighting

iWatt Inc. debuted an innovative digital AC/DC LED driver platform designed to address cost, performance and operating life in commercial and wireless solid state lighting (SSL) systems. The first device in this new platform, the iW3630 is a two-stage, Flickerless™ LED driver with output power up to 45 W and is believed to be the first SSL LED driver with a built-in 0 V to 10 V dimming interface for commercial lighting ballasts. It also supports a PWM digital dimming interface for wireless SSL applications.



**iWatt claims their new driver IC iW3630 to be first to work with 0 V to 10 V dimming systems, without the need for additional driver circuitry because of its built-in isolation transformer driver**

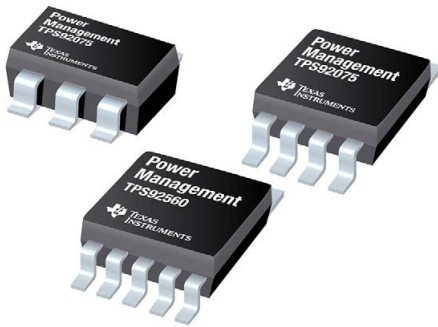
The highly integrated design of the iW3630 enables a 30% to 40% savings in bill of materials (BOM) cost compared to competitive solutions in 0 V to 10 V applications and, unlike alternative solutions, it maintains an extremely high power factor (PF) even at loads down to 20% of full load. It also offers a low total harmonic distortion (THD) of < 15%, to meet stringent global energy regulations, along with a built-in over-temperature protection (OTP) and de-rating function to improve the predictability and reliability of system operating life.

In both commercial and wireless applications, the built-in over-temperature protection and derating function means there is no need for additional components to control heat. Plus, iWatt’s patented PrimAccurate™ primary-side control technology eliminates the need for a secondary-side regulator and optical feedback isolator, while EZ-EMI® technology simplifies EMI filtering to further minimize the external component count. This combination of on-board functions results in a typical BOM of less than 70 components using the iW3630 compared to often more than 100 components needed using conventional SSL LED drivers. It also reduces the overall solution size and improves reliability. ■



## TI's New LED Drivers to Simplify Retrofit Light Bulb Design

Texas Instruments Inc. introduced the industry's smallest off-line, phase-dimmable, constant-current lighting controller and an easy-to-use lighting driver that simplify the retrofit of a variety of LED bulbs. The TPS92075 controller and TPS92560 driver reduce component count and solution size while improving compatibility with legacy lighting controls.

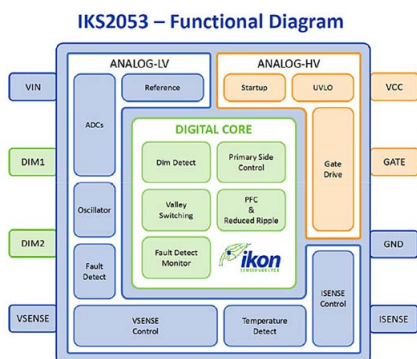


The TPS92075 and TPS92560 join TI's LED driver portfolio for retrofit bulbs that includes the LM3445, LM3447, TPS92310/11/14, LM3444 and LM3401

The TPS92075 is designed for phase-dimmable, offline AC/DC LED lamp and downlight applications. Offered in a very small 6-pin TSOT package, it achieves power factor correction above 0.9 while delivering smooth, flicker-free dimming when used with conventional wall dimmers. The TPS92560 is intended for use in low-voltage AC or low-voltage DC LED lamp applications such as MR16 and AR111. It uses a proprietary input current control method, which improves compatibility with electronic transformers. ■

## Ikon Semiconductor Unveils Digital Controller Technology for Solid-State Lighting

Ikon Semiconductor presented a digital controller Integrated Circuit (IC) technology for the dimmable LED retrofit market. The new technology is designed to meet cost and performance standards for today's LED lighting products, while also enabling greater design simplicity for bulb manufacturers and OEMs. Central to the IC's value is an innovative digital architecture that eliminates costly components – a benefit that reduces the form factor and improves reliability.



The key for Ikon Semiconductors' efficient and cost effective driver concept lies in the digital core of the IC with its sophisticated control algorithms

The IKS2053 is the first product in a series of novel, high-performance, single-stage controllers. The solutions easily match the efficiency of comparative two-stage architectures, but with up to 25% less components.

### LED Lighting

Perfectly adapted to your requirements

**dilitronics LED controller:**  
**Real quick-change artists**

- generate dynamic light
- reduce energy consumption
- create atmosphere and light comfort

[www.dilitronics.com](http://www.dilitronics.com)

**NEW:** <http://shop.dilitronics.com>

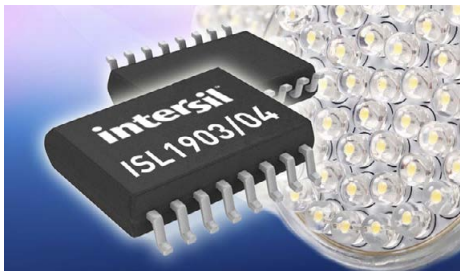
With broad dimmer compatibility and a compact size, Ikon Semiconductor's IC offers a better fit for LED bulb retrofits than larger, more complex solutions currently available. During Q2/2013 Ikon Semiconductor will present several interesting reference designs.

Commenting on the new technology, Conor McAuliffe, Ikon Semiconductor's CEO said, "Today, lighting accounts for nearly 20 percent of the world's electricity consumption. Largely driven by global legislation, inefficient legacy bulbs are steadily being replaced by energy-efficient lighting sources. LED lighting is the dominant replacement technology. Retrofit momentum is high, which presents a substantial market opportunity for Ikon Semiconductor. Added to this, our advanced dim-detect engine enables broad dimmer compatibility – an essential feature in a market saturated with disparate dimmer products. Our digital solutions represent a significant breakthrough for the solid-state lighting market."

A key advantage of the Ikon Semiconductor's digital technology is that it eliminates the need for opto-couplers and electrolytic capacitors – standard components that add complexity to the module and can hinder reliability. This is made possible by the proprietary digital control algorithms in Ikon Semiconductor's single-stage design. Moreover, the solution allows OEMs to decide the optimum trade-off between the amount of PFC (power factor correction) they need and the amount of ripple the design can tolerate. This capability simplifies the design process for bulb manufacturers, and relieves a further cost burden. ■

## Intersil's Latest Single Ended Buck LED Driver Controllers to Reduce Cost

Intersil Corporation has introduced two new LED driver controllers that deliver the industry's highest efficiency and dimming performance in industrial and commercial lighting systems.



**Intersil's ISL1903&1904 provide great dimming capability for isolated and non-isolated AC mains LED lighting applications**

The ISL1903 and ISL1904 are high-performance, single-ended buck and flyback LED driver controllers that support single-stage conversion of the AC mains to a constant current source with power factor correction (PFC). Designed for isolated and non-isolated power applications, the ISL1903 supports buck converter topologies. The ISL1904 supports isolated flyback as well as non-isolated SEPIC and Boost topologies. They operate in CrCM to allow near zero-voltage switching, maximizing both efficiency and magnetic core utilization.

Both devices deliver near-universal dimmer compatibility. Additionally, they can be used in DC or AC input LED ballasts and in universal AC mains input LED retrofit lamps.

## STM Introduces World's First Universal Lighting Controller

STMicroelectronics introduced the world's first programmable digital controller. It is specifically optimized for lighting and power-supply applications. The new STLUX385 (Masterlux™ platform) simplifies the design of traditional power-conversion topologies, enabling faster development of innovative domestic, commercial and public lighting systems.



**ST's STLUX385 is based on an advanced STM8 core with 16MHz and offers all relevant features for up-to date lighting controls**

The key to the new possibilities for improving the performance of LED, fluorescent and HID (High-Intensity Discharge) lighting systems is the STLUX385's combination of a proven, cost-effective STM8 microprocessor core and a unique set of peripherals aimed at simplifying the design of the lighting power supply and digital control of the lights. Depending on factors such as the lighting technology used, the input power source (AC or DC), dimming requirements and safety or reliability issues, many different types of power conversion and control topologies are required in the current and emerging lighting applications and the STLUX385 is the first device able to address all of these via a single programmable chip.

The STLUX385 achieves this goal primarily by integrating six specially-designed peripherals called SMED (State Machine, Event-Driven) circuits that interact with each other and with external signals via a programmable switching matrix to control the power delivered to the lighting elements. In addition to the specific application signals, the SMEDs can process external commands to turn the lights on/off or set the dimming level, diagnostic signals such as open or short circuit detected, or inputs from sensors in applications where the lighting is designed to adapt to ambient conditions.

In addition to the six SMED peripherals, the STLUX385 also integrates a hardware DALI (Digital Addressable Lighting Interface) peripheral. Digitally controlled lighting is the key to energy saving in building and outdoor lighting installations and the DALI protocol is now in international use across the lighting industry. The STLUX385 is compatible with wired or wireless communications, simplifying the installation in large indoor and outdoor areas and reducing maintenance costs. ■

## New Sensor and Signal Conditioner from JENCOLOR

MAZeT GmbH presents new JENCOLOR products for measuring tasks in the fields of colorimetry and LED light. The new products include the MTCSiCF color sensor for photometry and colorimetry, the MCDC04 sensor signal amplifier with an I<sup>2</sup>C interface and the MTCS-INT-AB3 sensor board for light applications.



**MAZeT's MTCSiCF color sensor (left) and MCDC04 signal conditioner (right) are the optimum combination for photometry and lighting control applications**

### MTCSiCF color sensor:

The MTCSiCF color sensor in its space-saving QFN16 housing (4 x 4 x 0.9 mm) is the latest member of the true color sensors family with XYZ filters. The sensor allows for the precise measurement of the color of materials, liquids or light in accordance with CIE1931/DIN5033. The sensors are well-suited to all applications that require an optimum ratio between price, overall size and colorimetry precision. At the same time, the human eye is used as the quality standard for the precision of color determination and colorimetry.

### MCDC04 signal conditioner:

The programmable signal conditioner IC facilitates an input signal resolution of up to 16 Bit and ensures a high synchronization of the channels across the working temperature range. The combination of the MTCSiCF color sensor with the MCDC04 is excellently suited for many photometry and light control applications.

### MTCS-INT-AB3 evaluation kit:

The MTCS-INT-AB3 evaluation kit is based on two ASSPs, which have been specially developed for tasks in LED light control. The MTCSiCF true color sensor implements colorimetry in accordance with the CIE1931 standard. The MCDC04 signal conditioner IC is an analog-digital converter with electricity input, a high bandwidth and I<sup>2</sup>C output. Both components are supplemented by the power supply. The board is perfect for OEM color sensor solutions in the Luv/Lav color space. ■

## Compact LED Driver with Wide Input Voltage Range from RECOM

With the launch of the new RACD20/277 series, RECOM Lighting extends its broad product portfolio of LED drivers to include modules with a stable 20 Watt output power and a universal input voltage range of 90 VAC to 305 VAC. Thus, they are suitable for global use.



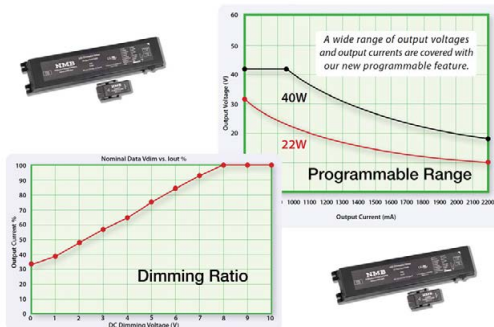
**RECOM's new RACD20/277 series with its compact design can be installed in applications with limited space**

The series is available in four variations with constant output currents of 350mA, 500mA, 700mA or 1050mA. All modules comply with the IP66 and provide standard active power-factor correction for a clean sine wave power without interfering harmonics, therefore ensuring "clean" light. The LED drivers provide input-to-output isolation of 3750VAC and impress with their very compact, slightly rounded shape. The modules have a size of 80 x 74 x 26.5mm, so they can be installed in applications with limited space.

The RACD20/277 family is fully certified according to the European safety regulations EN61547-1 and EN61347-2-13 as well as UL1310 Class B and UL8750. They also comply with EMC directives EN55015 Class B, EN61000-3-2 Class C and FCC Part 18 Class B. The series is suitable for use in industrial, commercial and residential sectors in both indoor as well as outdoor applications. The drivers are designed for reliable, durable operation and come with a five year warranty. ■

## NMB Introduces New 22~40W Programmable LED Driver

Flexibility and a smart design mark NMB's new programmable 22~40 W LED drivers. One single driver, covers output currents of 700 to 2200 mA. A simple programming function that offers the user the ability to program the driver's output current, based on specific requirements of their application, a 0~10 low voltage dimming feature, as well as IP66 and comprehensive protection, all surround the new design.



**The use of the CLSD005 Programming Box plus NMB's LED Driver Set-up Application Software allows programming of the CLSD Series Drivers current**

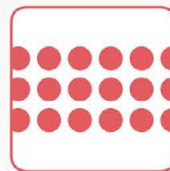


15th anniversary 2013  
1999-2013



**15<sup>TH</sup>**

**CHINA INTERNATIONAL OPTOELECTRONIC EXPO**



**A 360° View of the LED Industry**

- Materials & Components
- Packaging & Modules
- Lighting & Display
- Manufacturing & Testing Equipments

**SEPTEMBER 4-7, 2013**

SHENZHEN CONVENTION & EXHIBITION CENTER · CHINA

CONCURRENT EVENTS:



OPTICAL COMMUNICATIONS EXPO



LASERS INFRARED APPLICATIONS EXPO



PRECISION OPTICS EXPO

For more information, please visit:

**WWW.CIOE.CN**



**CHINA INTERNATIONAL OPTOELECTRONIC EXPO**

**CHINA INTERNATIONAL OPTOELECTRONIC EXPO OFFICE**

Add: Room 607, East Block, Coastal Building, Haide 3rd Road, Nanshan District, Shenzhen, Guangdong, 518054, China

Tel: +86 755 8629 0891 Fax: +86 755 8629 0951

E-mail: international@cioe.cn

The flexibility of this design is the ability to re-program the driver to adapt to changes in design requirements. Utilizing the practical programming kit (available separately), which includes a clip on programming unit and a USB cable, the desired output current levels can be easily preset or adjusted as your application develops. A simple online Windows based utility, accessible from NMB's web site, is available for one click programming, making this feature readily effective when designing or installing a complete space or maintaining an array of light sources. The designer or maintenance engineer has the ability to utilize the same programming kit to program as many drivers as necessary. ■

## IST All-in-One iDrive® Uno CV for Dimming Applications

Integrated System Technologies Limited announces the launch of the iDrive® Uno CV: a smart, single channel constant voltage LED driver, which is a perfect multi-protocol solution for applications where precision 8- or 16-bit dimming control is required.



**IST's iDrive® UNO CV: A multi-protocol, single channel dimmable LED driver**

When compared to the equivalent products of a leading competitor, the iDrive® Uno CV significantly outperforms on every level. The Uno CV offers an all-in-one protocol solution supporting DSI, DMX, DALI and RDM interfaces and operates at twice the current output, meaning the installer only requires one Uno CV driver for every two of the rival products, leading to significant installation cost savings. The Uno CV also operates at an exceptionally high output power (216 W) whilst offering superior safety features (short circuit, over voltage and over temperature protection) and the flexibility to operate with any PSU. ■

## Two New Power Vector LED Power Supplies

LumaStream introduces the Power Vector LED supplies THEA 56 and THEA 90. Both products feature an Auxiliary 12 V voltage source for active cooling. THEA 56 additionally includes a NTC that allows thermal feedback from a thermistor for active temperature control of the LED module and is also available with a 5 V auxiliary output upon request.



**While the THEA 56 is in serial production, the THEA 90 is available as an engineering sample**

THEA 56: 56 W constant current driver for powering and dimming high power LED arrays in the range of 1400 mA to 2100 mA. With its output voltage range from 10 to 28 Vdc is a good match for the 8x8 Bridgelux RS LED arrays or similar LED arrays.

THEA 90: 90 W constant current driver for powering and dimming high power LED arrays in the range of 2100 mA to 2800 mA.

The 2800 mA model with an output voltage range from 25 to 31 Vdc is a good match for the 10x10 Bridgelux RS LED arrays or similar LED arrays.

The 2100 mA model with an output voltage range of 27 to 42.8 Vdc is a good match for the new Bridgelux VERO LED arrays or similar LED arrays. ■

## New DC to DC LED Drivers from TRP

Thomas Research Products has introduced two new DC to DC LED Driver product lines. The LDC Series of DC to DC LED drivers are designed for smaller applications. The first offering is 25 W. Several different models are available, in constant-current and constant-voltage versions. Building on TRP's expertise and experience in LED Drivers, these units offer the same high quality, performance and long life as their existing driver lines.



**TRP adds one 25 W and one 60 W DC/DC LED driver to its broad range of LED driver products**

The LEDDC Series of drivers offers the flexibility of DC or AC input, allowing them to be utilized in a wider variety of applications. Initial availability includes 25 W and 60 W models, in constant-current (fixed or dimmable) and constant-voltage versions.

Like all LED drivers available from TRP, these products are designed for high quality, long life, high efficiency and cost-competitiveness. ■

## Ultra-Slim ArchiLume LED Driver Series from ERG Lighting

The ArchiLume Series of LED drivers from ERG Lighting has the slimmest 100 W drivers on the market for illumination applications requiring an elegant look with smooth, flicker-free dimming and constant voltage output up to 100 watts with very low ripple.



**ERG Lighting's ArchiLume LED drivers are ideal for applications such as architectural lighting**

Available in two versions - E100W24V and E100W24V-D - both are made and supported in the USA and have safety approvals for the US & Canada with a 5-year warranty. They provide universal input with minimum power factor correction of 0.90 and maximum total harmonic distortion of 20%. The E100W24V-D features onboard dimming with no flicker, no flashing, and ultra-smooth dimming all the way down to less than 1%. Both drivers measure 17.36" x 1.33" x 1.25" (441 x 34 x 32 mm). ■

# Modules & Optical Components With Diversified

❖ **LL01ED-AJMxxR18**  
D x H (mm) 35.2x7.8  
FWHM 24° 38°  
For Edipower II VF23,  
Citizen CLL010

❖ **LL01CT-AMXxxR18**  
D x H (mm) 44x11.8  
FWHM 55°  
For Citizen CLL010

❖ **LL03CR-EKxxL06**  
D x H (mm) 35x9  
FWHM 40° 60°  
For Nichia 183A

❖ **LL01ED-AQHxxL02**  
D x H (mm) 44x14.1  
FWHM 38° 45°  
For CREE XML-EZW

❖ **LL01ED-ABYxxL02**  
D x H (mm) 44x14.1  
FWHM 24°  
For CREE XML-EZW

❖ **LL03LU-BDOxxL06**  
D x H (mm) 35x11.6  
FWHM 15° 25°  
For CREE XBD

❖ **LL01ED-ASAxxL**  
D x H (mm) 90.6x22  
FWHM 12° 24° 38°  
For Citizen CLL030,  
CREE CXA2520

❖ **LL01CT-ALOxxR18**  
D x H (mm) 90.6x23.2  
FWHM 24° 38° 45°  
For Citizen CLL030  
Sharp GW5DLA

❖ **LL01ED-ALJxxR18**  
D x H (mm) 91.5x23.2  
FWHM 24° 38° 45°  
For Edipower II EPSx-HRBF,  
CREE CXA2520, CXA2530

❖ **LL01CR-APT220**

**PAR 38**

❖ **LL01ED-ABXxxL06**  
D x H (mm) 75.8x25  
FWHM 24° 38°  
For CREE MTG,  
Sharp GW5BMR,  
CREE CXA1512

❖ **LL01CT-ALNxxR18**  
FWHM 38° 45°  
D x H (mm) 75.8x20.3  
For Sharp GW5BMR  
Citizen CLL020

❖ **LL01ED-ALAxxR18**  
D x H (mm) 75x20.3  
FWHM 24° 38°  
For EdipowerII EPSx-HRB8,  
CREE CXA1512

❖ **LL01CR-APT240L**

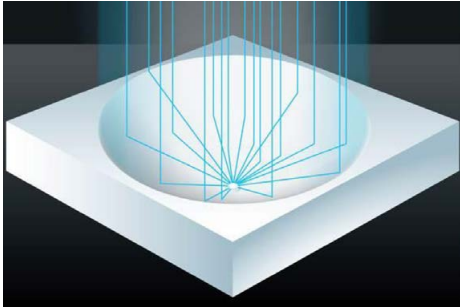
**PAR 30**

❖ **LL01CR-APT260L**

**Omni-Dirctional Bulb**

## Two Super-Reflective Thermx® PCT Grades for SSL

Ticona, the engineering polymers business of Celanese Corp., introduces a new generation of Thermx® polycyclohexylene-dimethylene terephthalates (PCT) that deliver outstanding properties required in LED packages found in display backlight and general lighting.



**Both Thermx® LED fiber filled, super-white polycyclohexylene-dimethylene terephthalates (PCT) compounds deliver outstanding initial reflectance and reflectance stability**

“Ticona scientists have developed two high performance super-white grades of Thermx PCT that meet the challenging requirements of LED reflectors, especially for high brightness, medium-power LEDs,” said Ruth Castillo, Thermx PCT and Vectra® / Zenite® LCP global business director - Ticona. “Thermx PCT provides superior color and reflectance stability under heat and light compared to commonly used high temperature polyamides.”

Thermx LED 0201 and Thermx LED 0201S are fiber filled, super-white PCT compounds. They withstand the demanding LED requirements for reflector resins with regard to heat and light stability - high initial reflectance; high reflectance stability under heat and light; excellent silicone adhesion; excellent processability; excellent mechanical properties; surface mount technology reflow capability; and low moisture absorption. This LED product family meets the optical and mechanical properties as well as the process requirements for specific applications.

In addition to possessing the desirable chemical resistance, processability, and dimensional stability of engineering polyesters, such as polyethylene terephthalates (PET) and polybutylene terephthalates (PBT), Thermx PCT provides added heat resistance, making it particularly well suited for demanding automotive and electrical/electronics applications. ■

## Larisa - LEDiL's New Miniature Optics Family

Small in size but high in efficiency. This versatile lens family is based on a convenient 10x10 mm footprint. Uniform size makes clustering easy and installation clips help mounting on to the PCB.



**Ultra compact but still very efficient, that is what LEDiL's Larisa series optics aim to be**

Larisa family features a comprehensive range of beam angles from real spot to extra wide, including oval. It has very good efficiency considering its size, exceeding in the range of over 80%.

Larisa family comprehensively supports different LEDs from all of the largest LED manufacturers, including Cree, Nichia, Philips Lumileds and Osram. ■

## Fraen Announces the Release of their New F3S Streetlight Optics

Fraen Corporation's Optics Division announced the release of their new line of F3S streetlight optics. The F3S streetlight series is offered in IESNA Type I, Type II and Type III lighting distributions and is compatible with a number of LEDs including Cree XTE, XPE, XPE2, XPG, XPG2; Philips Lumileds LUXEON R, Rebel, Rebel ES; Seoul Z5P, Z5M; and Osram Oslon SSL 150 and Oslon Square.



**The F3S lens is made of UV stabilized, optical grade polycarbonate**

Built around a common 2 x 6, one inch on center lens layout, the F3S series offers a highly flexible and scalable optical solution for a wide range of street lighting applications. Designed for ease of assembly, the F3S streetlight panel features locating pins for alignment, slots for screw attachment and a gasket groove to aid in designing for IP65 certification.

Constructed of optical grade, UV stabilized polycarbonate; the F3S lens panel delivers excellent weather and impact resistance in a UL94 V2 rated material. All F3S streetlight optics are REACH and RoHS compliant. ■

## HELENA – Precision Fresnel Optics Family

LEDiL's New Fresnel lens - HELENA - is an excellent example of precision engineering. The molding tool has been engineered to exacting standards using Diamond turning methods. This production method produces some of the highest quality optics in the world and allows Ledil to manufacture to an accuracy of a hundredth of a millimeter, thus giving great control of the light.



**HELENA's height accuracy of a hundredth of a millimeter which is achieved by special tooling guarantees excellent control of the light**

There are 2 variants - the HELENA-A is designed for a maximum intensity peak, giving good on axis candela values. HELENA-B is manufactured with some pillow texturing on the top side of the lens to widen and smooth the light fractionally.

HELENA is designed to work with Philips Lumileds LUXEON K series LEDs and it produces 22° beam angle. The HELENA has been designed to sit very close to light source this allowing compact fixture design. ■

## Carclo Introduces “Archimedes” & “Newton”

Carclo Optics has introduced 2 new families of reflectors – one new product is a high bay reflector, the other a large source reflector. Both of which have samples readily available.



**Carclo’s latest products are a high bay reflector and a large source reflector**

### “Archimedes” High Bay Reflectors:

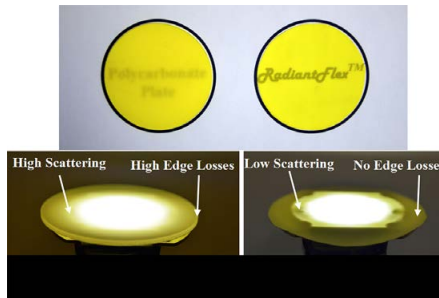
The new range of High Bay Reflectors are compatible with a wide variety of LEDs. Through our industry leading in-house design team, the ‘Archimedes’ family provide even illumination across the floor. There are medium and wide beams available in single and quad array variants. Attachment configurations include taped, glued, clipped or screwed.

### “Newton” Large Source Reflectors:

The 2<sup>nd</sup> reflector range that is being launched by Carclo Optics is a new Large Source Reflector family – also compatible with a wide variety of LEDs with different beam angles and fixing solutions available. The faceted reflector design ensures the ‘Newton’ Large Source Reflector provides smooth beams in both medium and wide angles. It is also compatible with the TE Connectivity® System. ■

## High Performance Flexible Phosphor Sheet

PhosphorTech is proud to introduce RadiantFlex™, a new revolutionary patent-pending flexible phosphor sheet for solid-state lighting and display applications. This product offers unparalleled flexibility, not just in terms of its physical properties, but also the infinite possibilities and high durability that it offers the LED packaging and luminaire designer.



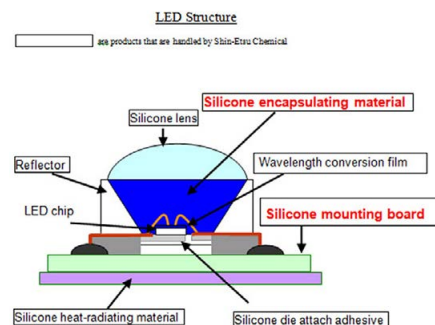
**RadiantFlex™ standard sheets, which are offered in a size of 8 x 11 inches, are used to demonstrate the advantage in scattering performance and edge losses compared to conventional remote phosphor**

PhosphorTech claims their newly invented and patent-pending RadiantFlex™ to be more efficient than other remote phosphor products because of reduced edge losses and a minimum of scattering losses.

The thin (10X thinner than conventional remote phosphor) and light (12X lighter than conventional remote phosphor) product is user customizable to different shapes and virtually any color and therefore allows new designs and lighting creations. ■

## High Refractive Index Silicone from Shin-Etsu

Shin-Etsu Chemical Co., Ltd. announced that it has developed new silicone material products for high-brightness LEDs. The new LimpidSi LPS-3600 Series is a high-reliability silicone encapsulating material and the LED Tiger SG Series is silicone-based mounting board that has superior thermal stability and laser resistance. These new materials will be used for lighting devices and for backlighting for LEDs. Shin-Etsu will begin sample shipments mainly for these applications.



**The high refractive index of 1.55 helps to improve the brightness of HB-LED packages by 3%**

# A Universe of Light Measurement Solutions



## LED Measurement Systems

StellarNet offers a complete line of portable, low cost LED test and measurement systems covering the 200-1700nm range. All instruments are NIST calibrated to measure the absolute intensity, with a selection of low cost integrating spheres ranging from 2" to 12" in diameter. These systems offer rugged, high performance measurements by utilizing shock-proof enclosures and permanently aligned optics to suit all your LED measurement needs, including QC and R&D applications.

- Irradiance (watts/m<sup>2</sup>, μwatts/cm<sup>2</sup>)
- Luminous Flux & Luminance
- Illuminance (lux)
- Radiant Flux (watts)
- Color Temperature (CCT)
- Color Rendering Index (CRI)
- Dominant Wavelength & Purity
- Chromaticity coordinates x,y



813.855.8687 | www.StellarNet.us

**The LimpidSi LPS-3600 Series of silicone encapsulating materials for LEDs**

The LimpidSi LPS-3600 Series is a product that simultaneously realizes a high refractive index and low gas permeability. These are strong characteristics of phenyl silicone, and superior thermal stability and laser resistance, which, in turn are strong characteristics of dimethyl silicone.

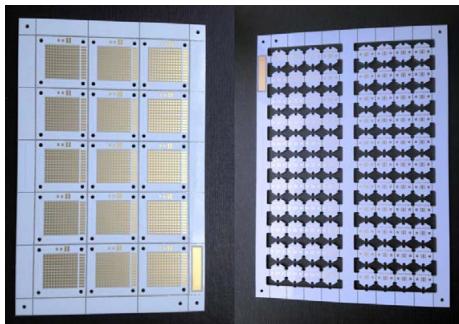
The refractive index of this new product is 1.55 nd25. This is the highest refractive index among any of the high-reliability silicone encapsulating material products on the market. With this new product, the brightness of LEDs is improved by 3% over that of conventional LEDs.

**The LED Tiger SG Series of silicone-based mounting boards for LEDs**

The LED Tiger SG Series is a silicone glass laminate used as a mounting board, which is mounted under the LED's light-emitting device. It has superior thermal stability and laser resistance and has the characteristic that even though it is exposed for a long time under high-brightness light-emitting conditions no degradation of the LED's brightness occurs. ■

**Cambridge Nanotherm - Industry-Leading Metal-Backed PCBs**

Cambridge Nanotherm has launched Nanotherm™ MBPCB (Metal-Backed Printed Circuit Board), the culmination of two years of innovative development using Cambridge Nanotherm's ceramic dielectric technology. This has resulted in an innovative thermal management material, with a dielectric thermal conductivity of 7 W/mK, which is able to significantly reduce LED die temperatures.



**The Nanotherm™ PCBs promise to reduce LED temperatures by as much as 20°C compared to other MBPCBs**

The company's core IP exists in its unique process for converting aluminum into alumina (Aluminum Oxide [Al<sub>2</sub>O<sub>3</sub>]). This process allows the surface of an aluminum plate to be converted into a layer of alumina – which acts as a dielectric. A range of standard Printed Circuit Board fabrication techniques can then be used to apply circuitry onto the nano-ceramic dielectric layer.

"The ceramic layer has a bulk thermal conductivity of 6-7 W/mK and can be applied in thicknesses as low as 10 micron, resulting in a thermal resistance as low as 0.012°Ccm<sup>2</sup>/W." explained Dr. Pavel Shashkov, the CEO and Founder of Cambridge Nanotherm.

Independent testing of the Nanotherm™ MBPCB, in LED lighting applications, has shown that it offers a 20% reduction in substrate thermal resistance over some of the best available metal-backed PCBs. In back-to-back comparison testing with other metal-backed PCBs, LED temperatures were seen to be reduced by as much as 20°C, thus allowing designers to increase component density and power or give longer lifetime guarantees. ■

**SinkPAD Unveiled Best Thermal Management Star PCBs**

SinkPAD is announced availability of SinkPAD Star PCB for the new Luxeon-T and the Cree MK-R LEDs. You can come reserve your samples by visiting our website.



**LED on SinkPAD star**



**Luxeon-T**



**Cree MK-R**

**Lighting Innovator, Ian Osborn, calls these Star-PCBs the "The Fastest Heat Moving Technology on the market"**

The new thermal management printed circuit boards are a complete and effective solution to the challenges faced by the solid state lighting industry, specifically those with high power LED PCB applications.

Thermal Comparative Test results from customers continue to validate the SinkPAD™ MCPCB as an innovative technology in thermal management of LEDs.

SinkPAD™ conducts heat out of the LED system (LED cooling) by creating a direct thermal path between the LED and the surrounding atmosphere, which eliminates thermal resistance of the dielectric material in a traditional IMS PCB or MCPCB. SinkPAD™ still uses a dielectric, but this dielectric isolates the metal base electrically and leaves it thermally connected. ■

**Molex LED Array Plastic Interconnection Technology**

Molex Inc. announces a new development in LED array holder technology with integral electrical, mechanical and optical connectivity for optimal performance and to simplify design integration for lighting manufacturers.

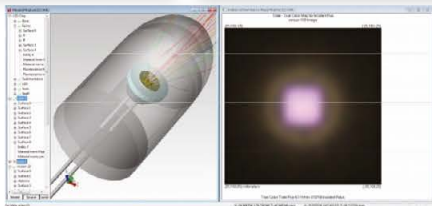
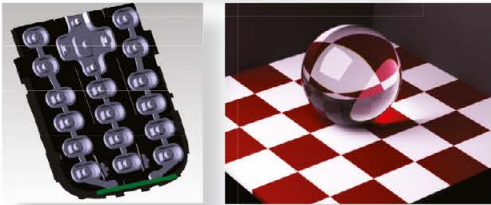
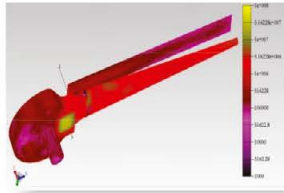


**The industry's first integrated plastic interconnection system from Molex enables easier, faster and more flexible application of LED arrays**

Existing LED arrays represent a challenging compromise between the LED array metal printed circuit boards or ceramic substrates being small enough to minimize costs and deliver the optical performance required while also providing electrical, mechanical and optical attach features to make them easier to use in a lighting system. The new technology from Molex transfers the connectivity and ease of use features from the LED array metal or ceramic substrate to a separate plastic body substrate, allowing for improvements in thermal, optical and mechanical interconnect functionality. This plastic body substrate can be combined with the LED array package in a number of ways to provide an array top side surface with multiple connection choices.



# TracePro - The Most Productive LED Illumination Design Software



## Create Optimal Systems Faster Using TracePro's Newest Design Tools!

- ▶ **Lit Appearance** – Verify the lit appearance of your design from any eye and target position with TracePro's rendering algorithms
- ▶ **3D Irradiance/Illuminance Maps** – Visually check light propagation on every part and surface for power, CIE, or true color before manufacture
- ▶ **3D Interactive Optimizer** – Use the new built-in sketch utility to create any type of CAD geometry, raytrace interactively to create the best initial design, digitize in target criteria, and control every step of the interactive optimization process



Try TracePro free for 30 days  
[www.lambdares.com/trials](http://www.lambdares.com/trials)

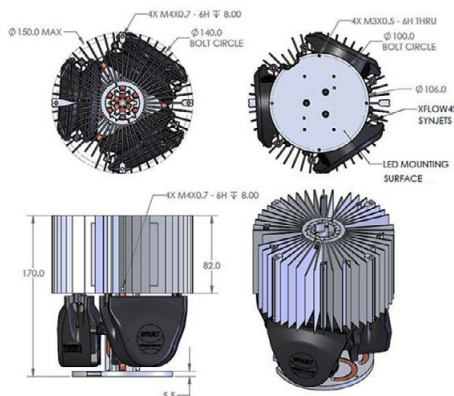
[www.lambdares.com](http://www.lambdares.com) • [sales@lambdares.com](mailto:sales@lambdares.com) • 978.486.0766 Phone • 25 Porter Road, Littleton MA 01460

This new technology, co-developed with Bridgelux, Inc., has been incorporated into the recently announced Vero array product family from Bridgelux. The interconnect technology is expected to make future LED array products easier to integrate and more cost effective, enabling lighting OEM's to reduce system costs, decrease time to market and to improve the reliability of LED luminaires they design. These advances include thermally isolated solder pads, an integral Molex Pico-EZmate™ header, and improved mechanical attach and optical reference features, all while maintaining a very low profile. The solder pads are designed to make direct soldering easier and more robust than soldering to current array packages made of materials such as aluminum or ceramics. The Pico-EZmate connector header option enables a solder free electrical interface and options for field service and replacement.

The plastic body, interconnect technology builds on technology from Molex that is used in consumer electronics and other high volume markets. Molex will offer a broad range of UL approved Pico-EZmate mating harness products for a robust interconnection system that is easy and cost-efficient to implement with the entire Vero product range. ■

## Nuventix Presents its New Industrial LED Cooler R150-170

Nuventix, Inc. introduced its flagship high bay product the LED Cooler R150-170, in answer to the ever evolving cooling needs of the LED industry. Built with the company's patented SynJet technology, the new high bay LED cooler is 33 percent smaller and 60 percent lighter than passive cooling equivalents used in industrial high bay fixtures, and is easy to fit into pendant form factor designs.



**The new Nuventix industrial SynJet LED Cooler R150-170 can be equipped with up to three SynJets for maximum performance to handle a thermal wattage of up to 154W**

The modular solution can be used independently as a stand-alone heatsink or with up to three SynJets, enabling flexibility in design and cooling and allowing for an entire line of low bay and high bay luminaires with the same form factor. Due to its heat pipes and the SynJet air transfer, the R150-170 has exceptional heat spreading and can cool up to 20,000 lumens in a round shape design. The efficiency of this design allows for the use of low cost compact LED arrays running at high currents without sacrificing color quality, brightness, or lifetime.

The R150-170 high bay solution reduces the total cost of ownership of the LED system by maintaining thermal performance over the life of the system, saving on maintenance costs for end-users. Customers will also realize more than 30 percent energy cost reduction from fluorescents and more than 40 percent from 400-watt metal halides.

LED lighting manufacturers will also realize substantial cost savings with the R150-170 SynJet solution. Because of the R150-170 cooler's advanced thermal spreading and heat transfer capabilities, lighting manufacturers will be able to use smaller, less-expensive LED arrays and still achieve high color quality and lumen output. ■

## Fischer Elektronik - New WLPK Heat Conducting Paste

Fischer Elektronik's new innovative WLPK heat-conducting paste meets the requirements of the market for a heat-conducting paste with high thermal conductivity (10 W/mK).



**Fischer Elektronik's WLPK Heat-conducting Paste series is filled into 3, 5 and 10ml plastic syringes**

The ceramic-filled, silicon free heat-conducting paste consists of a synthetic polymer and enables quick as well as effective heat dissipation in a temperature range of -60°C to +150°C. The paste does not harden, dry out or melt under normal application conditions and, furthermore, is not subject to any special storage requirements. For ease of application, the WLPK Heat-conducting Paste series is filled into 3, 5 and 10ml plastic syringes as standard. Other package sizes and types can be supplied in accordance with specific customer specifications. ■

## DSM Launches Stanyl ForTii LED LX Solution

DSM has introduced Stanyl® ForTii™ LED LX, an LED (Light Emitting Diode)-specific grade of Stanyl ForTii high temperature polyamide with halogen-free flame retardant grades as a material solution for LED packages.



**DSM's Stanyl ForTii LED LX solution for LED packages provides excellent UV resistance and is capable of high power densities**

High-flow Stanyl ForTii LED LX is a mineral-filled grade, and its excellent UV resistance sets a new standard for LED packages. Stanyl ForTii LED LX delivers a good reliability performance over time and, more specifically, high initial reflectivity, as well as excellent mechanical strength.

Its high flow properties make it suitable for use in high cavity tools. This enhanced reflectivity of Stanyl ForTii has an immediate effect on the LED package light output and enables LED suppliers to improve their key specifications.

Stanyl ForTii LED LX outperforms competitive PPAs thanks to its specific polymer structure. High reliability and LED lifetime are further enabled through its excellent adhesion to silicones and epoxy encapsulates as well as the metallic lead frame, avoiding chip degradation due to moisture or air diffusion through interfacial delamination phenomena. ■

## LSCG Launches A19 Definity™ LED Lamps

Lighting Science Group Corporation® (LSCG) launched revolutionary "Edison inspired" A19 and GP19 LED lamps as a direct replacement for traditional general purpose lighting. Created with the most advanced thermal materials available, these lamps are unmistakably lighter and more efficient, while less expensive, than ever before. These LED-optimized lamps truly replicate the form, weight and function of the incandescent Edison-shaped bulb that is most familiar to residential consumers and professionals alike.



**LSG introduces DEFINITY™ Professional bulbs for 40 & 60 W replacement**

The Definity Professional A19 LED lamp achieves superior performance with up to 71lm/W and is easily dimmable down to 5%. Performance is achieved with a reduction in raw materials and an innovative heat sink design comprised of advanced CoolPoly® material resulting in superior thermal management with lighter weight.

The Definity Professional GP19 LED lamp utilizes lightweight aluminum and cutting-edge design to optimize the performance and aesthetics. The GP19 LED lamp achieves ENERGY STAR equivalency performance comparable to a 40W lamp with the increased efficiency and life that can only be provided by LED technology. The GP19 Led lamp also tops 80 lm/W and is also down to 5%. ■

## ENERGY STAR® Qualified Frosted A Type LED Lamp

Ideal for usage in downlights, pendants, sconces, desk lamps and chandeliers, MaxLite unveils the 11-watt LED A Type Frosted Lamp featuring outstanding efficacy and lumen life maintenance, which has been added to the ENERGY STAR® list of qualified products. The versatile, fully dimmable lamp performs well in a broad range of residential and commercial applications where energy savings and minimal maintenance are preferred.



**All LEDs in the new MaxLite 60W equivalent replacement lamp are matched for color and CRI to ensure consistency and quality**

The LED A Type saves up to 90 percent in energy while replacing a 60-watt incandescent lamp. The LED lamp delivers a substantial efficacy of 72 lumens per watt that directly correlates to the ENERGY STAR® program's objectives of helping save money by reducing energy costs and protecting the environment.

The lamp's LEDs are matched for color and CRI to ensure consistency and quality. Lumen maintenance is greatly enhanced by the housing, which is a proprietary design that acts as a heat sink to provide thermal heat conductivity and maintain a low junction temperature, resulting in a cool operation, long lumen life and better performance. ■

24th - 25th June 2013 , The ICC, Birmingham, UK



Visit Europe's key event for the Science and Technology of LEDS



**Show Highlights:**

High profile, technical conference programme  
Over 100 exhibitors expected from all over the world  
Network with a vast number of industry professionals  
Catch up on all the latest in LED innovations



Conference from £199 + VAT  
Exhibition Free to Attend  
Gala Dinner from £65 +VAT

Register now at [www.euroLED.org.uk](http://www.euroLED.org.uk)

Contact the team: Michelle Cleaver or Katie Fulcher on +44 (0)121 250 3515 or [info@euroLED.org.uk](mailto:info@euroLED.org.uk)



## SSC and Verbatim Introduce MR16 Replacement Lamps

To address market requirements for LED lamps that more closely approximate the characteristics of halogen lighting, Verbatim will launch a new range of LED products based on Seoul Semiconductor's "nPola" technology.

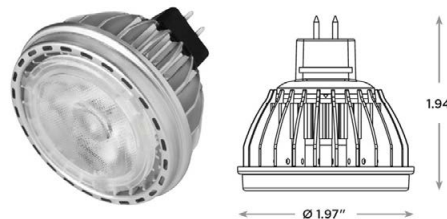


**Verbatim's new MR16 replacement lamps use SSC's nPola technology**

Verbatim's initial launch of nPola halogen LED lamps will focus on the MR16 form factors, with a primary target of 50 W MR16 halogen equivalency. The combination of high light output and beam characteristics that closely resemble halogen lamps will allow lighting designers and contractors to adequately replace halogen lighting. ■

## Cree Announces LM16 LED Lamp

Using up to 80 percent less energy and designed to last up to eight times longer than traditional 50-watt halogen MR16 lamps, the Cree® LM16 LED Lamp delivers a new standard in LED lighting. The new lamp can deliver payback in less than 12 months and provide years of consistent color quality and lumen output. The high-performance LM16 LED Lamp delivers the industry's best center beam candlepower for 25° beam angles.



**Cree's new LM16 LED lamp fits the geometrical specifications for MR16 halogen lamps exactly and delivers up to 620lm @ 9W**

The new LM16 LED Lamp not only matches the performance, appearance and ANSI form factor of the traditional halogen lamp, but also works with a broad range of transformers and dimmers to seamlessly replace it in existing

systems. Embedded protective dimming circuitry and intelligent thermal software in combination with the innovative Cree fanless housing design help deliver a long lifetime of quality and performance.

The Cree LM16 50-watt halogen equivalent delivers 620 lumens (consuming only 9 W) and the 35-watt halogen equivalent delivers 425 lumens (consuming only 7 W). The new lamps are designed to provide a minimum of 25,000 operating hours, reducing the need to replace lamps. The 50-watt equivalent is dimmable to five percent on a broad range of dimmers and transformers. The new Cree LM16 LED Lamp is available in three beam angles, including 17° spot, 25° flood and 40° wide flood.

"The technology and performance of the new Cree LM16 LED Lamp demonstrates Cree's commitment to accelerate the adoption of LED lighting," said Greg Merritt, vice president, marketing, lighting at Cree. "Optimizing each design element – optics, drivers, thermal management and our proprietary lens design, Cree continues to develop new LED technology that is energy-efficient and provides outstanding performance and value to our customers." ■

## Pro-Lite Introduces New Innovative Lux-Meter

Pro-Lite Technology Ltd. announced the release of the portable SL-3101 photometer which measures both photopic and scotopic illuminance and also automatically computes the S:P ratio of the light source under test.



**Pro-Lite Technology's new portable luxmeter offers both metering of photopic and scotopic illuminance**

Using two sensor heads connected to a single portable meter, the SL-3101 provides a more meaningful measure of the effective illuminance of light sources under low light level conditions. The measurement of scotopic lux and the ratio of scotopic to photopic illuminance are of growing importance in many applications, in particular in the assessment of the visual effectiveness of street lighting. The measurement of S:P ratio is called for in the BS 5489-1:2012 Code of Practice for the Design of Road Lighting and in the ILP's Professional Lighting Guide, PLG 03 (2012). Used to measure spectral response following the standard CIE scotopic and photopic observer functions, the SL-3101 is one of the most innovative meters currently available. ■

## New Benchtop Multi-Point Analyzer

Precision sensor manufacturer Micro-Epsilon has launched a series of bench top multi-point measurement systems that enable faster, easier inspection of LEDs. The colorCONTROL MFA series starts with a basic version that offers five measuring channels. The colorCONTROL MFA-5 is extremely compact and can verify the color, intensity and color temperature (in Kelvin) of up to five LEDs simultaneously. The measuring system is modular and so can be extended by adding extra MFA-E modules in batches of five channels, up to a maximum of 20 modules.



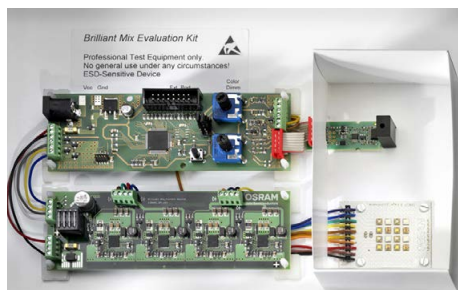
**Micro-Epsilon's new bench top multi-point measurement systems are intended to enable faster, easier inspection of LEDs**

The MFA is suitable for a wide range of applications, including LED tests (binning), indication and displays, front panels, dashboard sequence tests, self-luminous object inspection. The MFA series is suitable for all manufacturers and developers of LED luminaires, including architectural and street lighting, and LED lighting for automotive interiors.

The MFA series can be used as a bench top system for inspection of LEDs or as an online, automated test system. The MFA series is also supplied with set up and configuration software as standard. ■

## Brilliant Mix Universal Controller for Fast Evaluation

The Brilliant Mix LED color mixing concept from Osram Opto Semiconductors is now even easier to control thanks to the new Brilliant Mix Universal controller from Elec-Con technology. The controller is available in a standard version – with or without a sensor – and in a customized version. It can be adapted to current building systems standards, such as DALI, KNX and EIB. The controller concept has been developed as part of the LED Light for you network.



**Osram's Universal Controller enables the user to implement Brilliant Mix applications quickly and easily without needing any special control know-how**

A highly usable standard product is now available in the form of the Universal Controller. The controller has a modular structure, in other words the controller unit, driver and sensor are separate components. This gives luminaire designers greater flexibility because the components do not have to be arranged next to one another or on top of one another but can be placed anywhere. The standard driver has four channels so that individual LEDs – for example in different colors – can be controlled individually. Multiple drivers can be connected to a controller to improve performance.

The modularity of the controllers means that different versions can be produced - a standard version without a sensor, one with a sensor, and various customized versions of different shapes and sizes. The sensor enables the required brightness and color location to be controlled in accordance with a preset customer-specific value. This ensures, for example, that all the luminaires in a room have the same light color. It is also possible to adjust the LEDs throughout their lifetime so that different rates of aging among LEDs of different colors do not have an adverse effect on the overall effect of the light. Dieter Bauernfeind, Managing Director of Elec-Con technology is extremely pleased: "The modularity of the system makes it easy for us to meet specific customer requirements and supply relatively small production runs."

What all the versions of the controller have in common is that they make it easier to use the Brilliant Mix concept and speed up the implementation of lighting solutions. Thanks to the Universal Controller in combination with the drivers, the light engine and the sensor module it is no longer necessary to have special control know-how. Brilliant Mix applications can therefore be put into practice quickly, easily and therefore economically with efficient use of resources.

"True to the purpose of our network, namely to offer our customers simple solutions, we have developed the Universal Controller in cooperation with our partners," added Sebastian Lyschick, responsible for LED Light for you (LLFY) at Osram Opto Semiconductors. Also involved in the development, in addition to the LED manufacturer, were Infineon Technologies, Elec-Con technology and MAZeT. ■

We bring quality to light.



Putting LEDs in the right light.

**SSL solutions from the world leader in LED measurement**



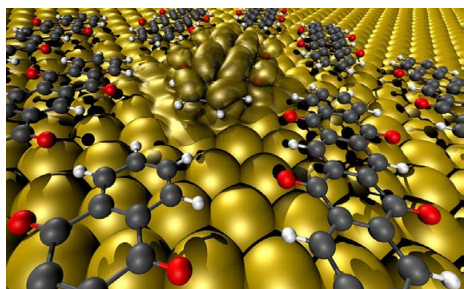
Instrument Systems set the benchmark in LED testing with high-performance spectroradiometers for photometric and colorimetric measurements. Now we present another breakthrough in Solid-State Lighting with our new goniophotometers and integrating spheres.

**Find out more about our innovations for SSL:**  
[www.instrumentsystems.com/ssl](http://www.instrumentsystems.com/ssl)

 **Instrument  
Systems**  
light measurement

## Contact between Carbon Compounds and Metals

Organic electronics has already hit the market in smartphone displays and holds great promise for future applications like flexible electroluminescent foils or solar cells that convert sunlight to electricity. A reoccurring problem in this technology is to establish good electrical contact between the active organic layer and metal electrodes. Until now, however, it was practically impossible to accurately predict which molecules performed well on the job. They basically had to be identified by trial-and-error. Now, an international team of scientists around the HZB and the Humboldt University Berlin has unraveled the mystery of what these molecules have in common. Their discovery enables more focused improvements to contact layers between metal electrodes and active materials in organic electronic devices.



**The secret is to change the molecules' internal structure in such a way that they lose their semiconducting properties and instead adopt the metallic properties of the surface**  
(Visualisation: Georg Heimel /HU Berlin)

The researchers systematically examined different types of molecules whose backbones consist of the same chain of fused aromatic carbon rings. They differed in just one little detail: the number of oxygen atoms projecting from the backbone. These modified molecules were placed on the typical contact metals gold, silver, and copper.

Using photoelectron spectroscopy (UPS and XPS) at HZB's own BESSY II synchrotron radiation source, the researchers were able to identify chemical bonds that formed between the metal surfaces and the molecules as well as to measure the energy levels of the conduction electrons. Colleagues from Germany's Tübingen University determined the exact distance between the molecules and the metal surfaces using x-ray standing wave measurements taken at the ESRF synchrotron radiation source in Grenoble, France.

These experiments showed that, upon contact between the oxygen atoms protruding from the backbone and several of the metals, the molecules' internal structure changed in such a way that they lost their semiconducting properties and instead adopted the metallic properties of the surface. Despite similar prerequisites, this effect was not observed for the "bare"-backbone molecule. From the observation which molecules underwent these kinds of drastic changes on what metal, the researchers could derive general guidelines. The researcher now have a pretty good sense of how molecules ought to look and what their properties should be if they are to be good mediators between active organic materials and metal contacts. ■

## KIT Demonstrates Light from Silicon Nanocrystal LEDs

Scientists of KIT and the University of Toronto have now succeeded in manufacturing silicon-based light-emitting diodes (SiLEDs) based on nanocrystals with a size of a few nanometers. They are free of heavy metals and can emit light in various colors. The development was presented in the "Nano Letters" journal.



**Liquid-processed SiLEDs: By changing the size of the silicon nanocrystals the color of the emitted light can be varied**  
(Photo: F. Maier-Flaig, KIT/LTI)

Silicon dominates in microelectronics and photovoltaics industry, but has been considered unsuitable for light-emitting diodes for a long time. However, this is not true for nanoscopic dimensions: Minute silicon nanocrystals can produce light. These nanocrystals consist of a few hundred to thousand atoms and have a considerable potential as highly efficient light emitters. In a joint project, scientists from KIT and the University of Toronto have now succeeded in manufacturing highly efficient light-emitting diodes from the silicon nanocrystals.

So far, the manufacture of silicon light-emitting diodes has been limited to the red visible spectral range and the near infrared. As regards the efficiency of silicon diodes emitting red light, researchers from Karlsruhe are already top in the world. Controlled manufacture of diodes emitting multicolor light, however, is an absolute novelty. KIT scientists specifically adjust the color of the light emitted by the diodes by separating nanoparticles depending on their size. Moreover, these light-emitting diodes have a surprising long-term stability that has not been reached before. The increased service life of the components in operation is due to the use of nanoparticles of one size only. This enhances the stability of the sensitive thin-film components. Short circuits due to oversized particles are excluded. ■

### WEBINARS



#### Obtaining the Highest Candle Beam Power for Spotlights

Lumen density in the LED source is very significant in final design. Obtaining Center Beam Candle Power is a goal in high quality applications including retail and architectural lighting. High Power LEDs are the perfect solution to creating high lumen intensity from a very small light emitting source. Creating a very high lumen per mm square enables the highest center beam candle power in a system. Where other COB's need ~35-35mm for high lumen packages, LUXEON S5000 can achieve 8000 lumens in a Light Emitting Surface of just 17mm. Creating great spotlights has never been easier.

To view the webinar, register at [www.led-professional.com/webinars](http://www.led-professional.com/webinars)

**PHILIPS  
LUMILEDS**



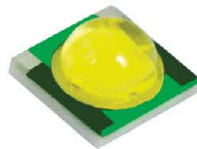
4014

Small size, flexible design for finish product.



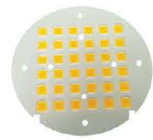
PW16

Refond special mattlens surface Technology, Completely Solved facula problem.



3535

Refond's distinctive silicon molding.



COF

Patented surface Light source.



Stock Code: 300241

LED Lighting Source and integral solution supplier.

Tel: +86-755-29675000 Fax: +86-755-29675111  
[www.refond.com](http://www.refond.com)

# Labeling and Certification Testing Issues

Arno Grabher-Meyer from LED professional summarizes several issues regarding certification and certification processes which were discussed with David Edwards, an expert in testing and compliance engineering for consumer products at UL.

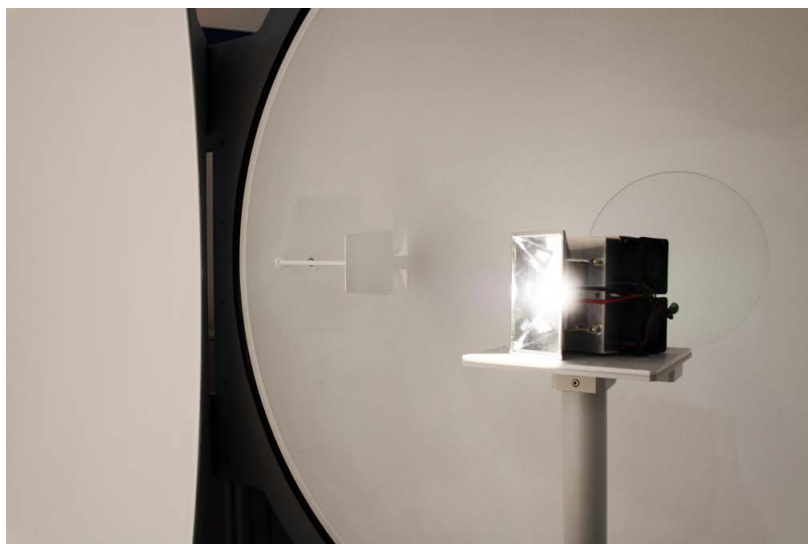
**Figure 1:**  
For LM-79 tests, total luminous flux of luminaires is measured with integrating spheres

Certification and product labeling is one of the most complex topics that engineers face today. First of all, if we look at it from a manufacturer's point of view, it is costly. Secondly, it is time consuming and thirdly, it hinders quick market entry.

In this case, the question of why manufacturers should try to acquire certifications and labels that are not mandatory on top of all the required ones arises. The simple answer is that labels are necessary for providing a consistent and common language and information for manufacturers and consumers. In the end, they may even increase sales.

While safety certificates are mandatory and therefore not really noticed by the consumers, not every quality or efficiency related certification is mandatory. In some parts of the world quality and efficiency certification is not even required. However, during the past few years there has been a big increase in the number of consumers that are taking note of these labels. Energy usage is a main issue and especially in lighting, people are much more aware of efficiency and light quality.

In some cases, provided the required documents and proof is available, self-certification is possible. In other cases testing in a certification lab is compulsory. We will be discussing the compulsory lab testing certification.



## The Engineering Challenge

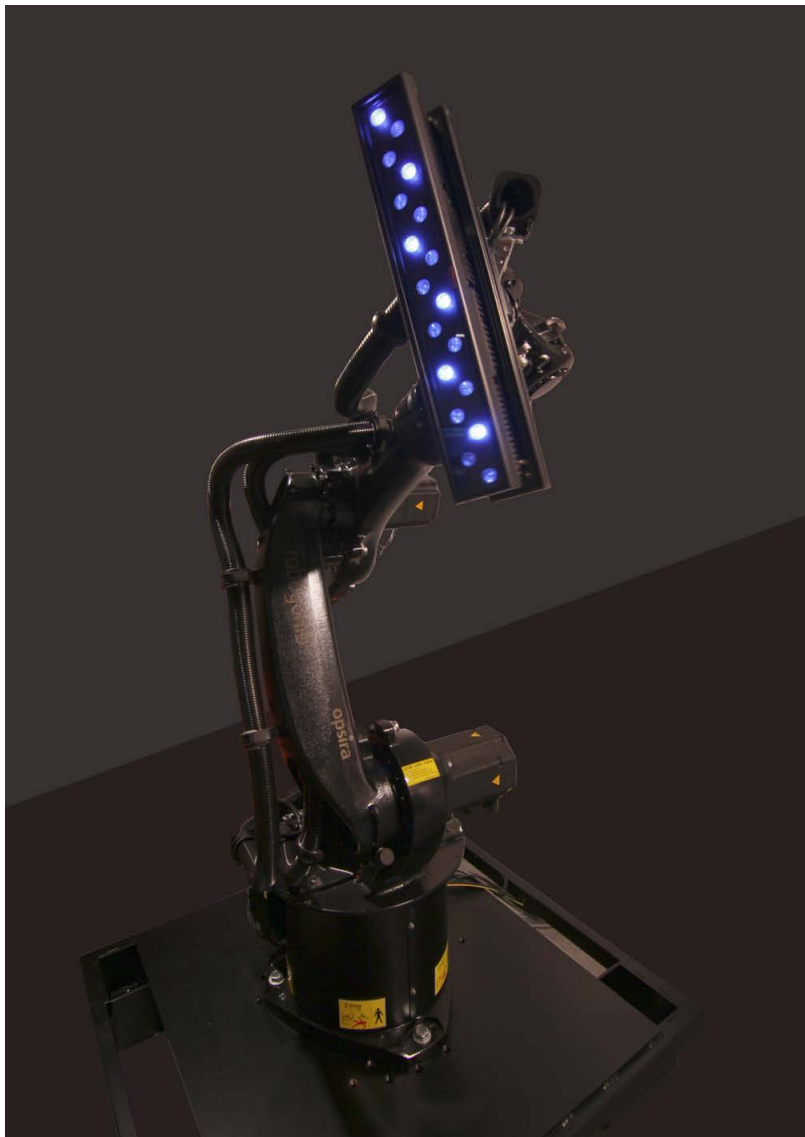
Although there have been attempts to harmonize the regulations, the necessity of certifying products, especially those that are sold internationally, is a challenge. The reason for this is the regionally specific technical issues that make different tests and requirements necessary. In many cases, a product must undergo 5, 10 or even more certification systems and labeling processes.

The pressure put on manufacturers for their products to have many different labels carries over to the engineer who has to design a product that can pass a number of different certification tests with good results. This isn't always easy and sometimes results in trade-offs. There is often no simple way to design a product for the stringent demands made on it

because the compulsory test procedures are much too different. An example of this may be a system that needs to resist pre-defined stress for a certain amount of time. The problems start when there is a significant difference in the amounts of time and stress required for the different certificates. For instance, one certificate may demand high stress to be applied to the system for a relatively short amount of time and another certificate demands a lower amount of stress to be applied for a significantly longer period of time. These are two completely different endeavors. Unfortunately, the results cannot be exchanged or accepted in a vice versa constellation. This is the case, not only for safety certificates but also for quality related certificates.



**Figure 1:**  
For LM-79 tests,  
luminous intensity  
distribution of  
luminaires is  
determined with  
goniophotometers



### Demands on Testing Labs

During the last few months, several testing organizations were criticized for being too costly or causing delays of product roll-outs because of limited testing capacities. The dissatisfaction is understandable, but we have to remember that testing equipment as well as qualified personnel is very expensive. In addition to that, SSL is at a stage where there are a high number of new product developments. Nobody knows how long this is going to last before product developments decrease again to a level for which the existing capacities are ample. This issue can be discussed interminably without coming to a satisfactory conclusion which is why we are only touching on it here and not going into detail.

### Applying for Energy Star

Besides efficiency labels like the Energyguide in the US and the European Union Energy Label, there are other labels that reach far beyond these requirements. The most important and at the same time, most demanding label, right now, is the Energy Star.

To help us understand what is really going on and what is relevant regarding labeling and the related certification processes, David Edwards provided LED professional with a clear guideline that demonstrates what is necessary and what affects the workflow of the certification process. His main aim is to clarify the time it takes to test LED lighting products for the applicable industry performance standards and to qualify products for the EPA Energy Star program.

There are two approved methods for LED light sources that result in replicable test measurements and a reliable comparison of test data that is generated by different laboratories.

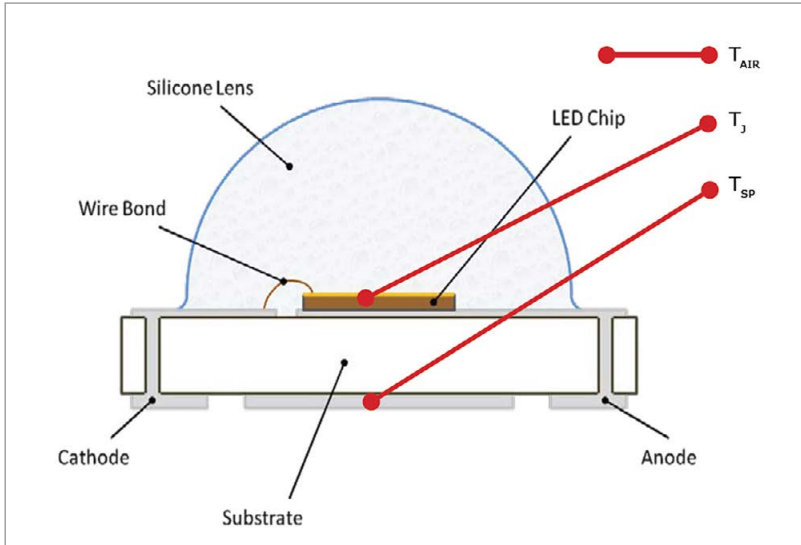
IES LM-80-08 “Measuring Lumen Maintenance of LED Light Sources” contains a process whereby changes in light output are measured under controlled conditions. This testing is typically conducted by the manufacturer of the individual LED light source. That data is then supplied to an end-user so that it may be utilized in future qualification testing.

IES LM-79-08 “Electrical and Photometric Measurements of Solid-State Lighting Products” describes the test methods for measuring Solid-State lighting luminaires or lamps. These test methods incorporate the use of absolute photometry for testing these products rather than relative photometry which had been the industry standard.

Test durations for each of these standards vary and can be summarized as the following:

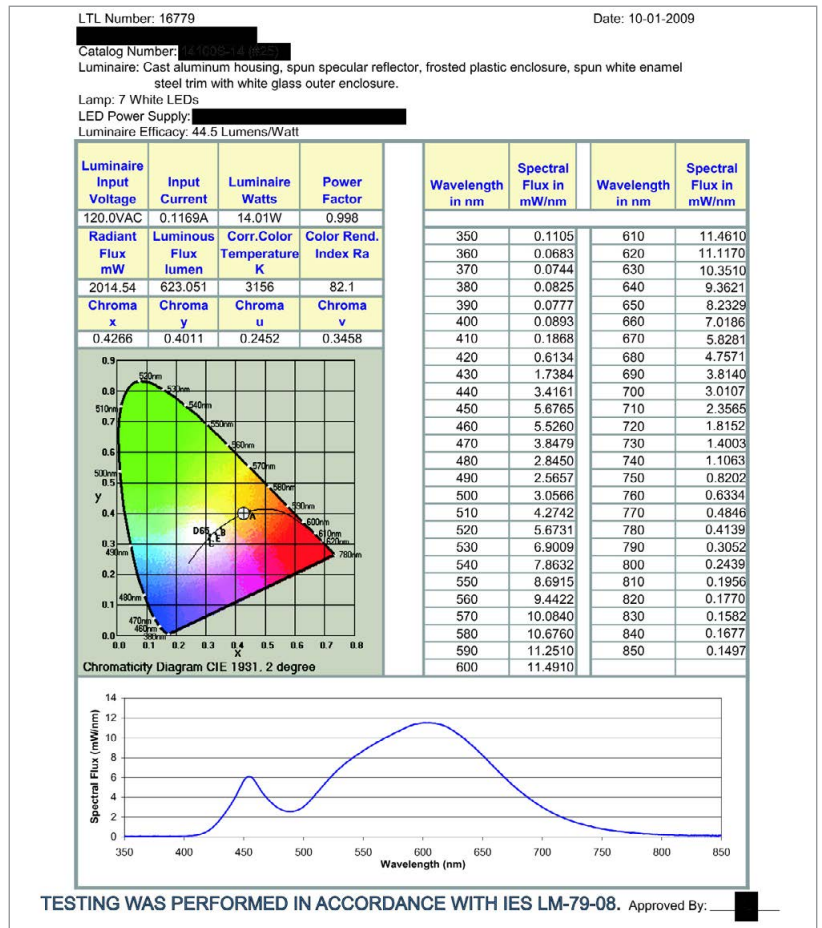
- For LM-80 testing, the units under test (JUT) will be driven for a period of at least 6,000 hours (250 days) under specified ambient conditions. Photometric and Chromaticity data is collected initially and at each 1000 hour interval. A test duration of 10,000 hours is suggested for better predictive modeling.
- For LM-79 testing of lamps and/or luminaires, the actual test time is typically 1-2 hours. Turn-Around-Times (TAT) can vary according to the testing lab, but are usually around 2-5 weeks.
- The Energy Star Integral LED Lamps standard calls for LM-79 testing along with the long-term test duration of 6,000 hours for determining lumen maintenance of the lamp. Energy Star does allow for early qualification at 3,000 hours, but LM-80 data for the individual LED is required to be eligible. If a manufacturer decides not to seek early qualification, then LM-80 data is not required.

**Figure 3:**  
Typical lumen maintenance temperature parameter measuring points for LM-80 test



- Energy Star for LED Luminaires. There are two options for determining lumen maintenance:
  - Option 1: This option requires In-Situ testing along with the LM-80 data supplied from the individual LED provider. In-Situ testing takes approximately 1 day to complete.
  - Option 2: For luminaire manufacturers who do not have LM-80 data, the fixture would be tested for 6,000 hours. This option is rarely utilized as most individual LED manufacturers supply the LM-80 data.
  - For additional information on Options 1 or 2, please refer to Energy Star® Program Requirements, Product Specification for Luminaires (Light Fixtures), V1.2.
- $\geq 91.8\%$  (indoor residential)
- $\geq 94.1\%$  (outdoor residential and all commercial)
- Measured during the in-situ temperature measurement test (UL1598/153), at the hottest TMP evaluated at  $\geq 6,000$  hours
- The drive current measured in the fixture is less than or equal to the drive current specified in the LM-80 test report

**Figure 4:**  
Excerpt of a typical LM-79 test report



**LM-79 Test**

LM-79 testing applies to LED products that incorporate control electronics and heat sinks. This covers complete LED luminaires and integrated LED sources. It does not include bare LED chips or LED products without the light source.

Integrating spheres in combination with a photometer, but preferably a spectro-radiometer that derives total luminous flux and color qualities from spectral radiant flux measurements, are used to measure the total luminous flux. A gonio-photometer is the appropriate tool to measure luminous intensity distribution. The gonio-photometer system tests may also derive total luminous flux and provide color characteristics including CCT and CRI.

**LM-79 testing gives information on key parameters for lighting planners:**

- Total Luminous Flux
- Luminous Intensity Distribution
- Electrical Power
- Luminous Efficacy
- Chromaticity
- CCT
- CRI

**LM-80 Test**

The LM-80 test report is essential to obtain the Energy Star label. The LM-80 test reports must illustrate that subcomponent lumen maintenance testing was conducted in accordance with the testing method outlined in IES LM-80-08, except as otherwise detailed in this document or in Energy Star specifications.

An LED Luminaire PASSES the Lumen Depreciation requirements if:

- The LM-80 test report for the package, array or module demonstrates lumen maintenance of:

### Latest Updates to Energy Star Requirements

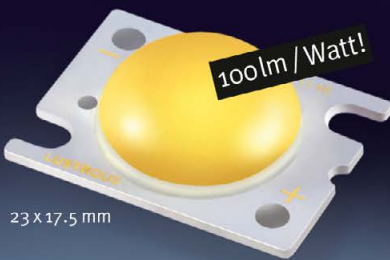
The U.S. Environmental Protection Agency (EPA) recently released the updated Energy Star® Luminaires Specification from Energy Star V1.1. to V1.2. This update incorporates many new details and topics. Because these changes not only refer to solid state lighting, the short overview summarizes all major changes and key-points:

- Removed all FCC requirements and references for EMI/RFI.
- Eliminated “Run-up time” criteria for Solid State Lighting products.
- “Noise” testing to be verified and documented by the manufacturer only.
- Postponed an anticipated increase in efficacy for non-directional luminaires, current minimum requirement of 65 lumens per watt remains in place.
- Reduced decorative light fixtures minimum output requirements:
  - o Ceiling fan light kits with 3 or more heads and outdoor porch lights = 450 lumens per head.
  - o Chandeliers, decorative pendants, and wall sconces = 250 lumens per head.

- Downlight color angular uniformity testing can now be done without the trim in place.
- Linear fluorescent fixtures are not required to ship with lamps:
  - o Fixtures that ship with lamps must meet Luminaire Version 1.2 requirements.
  - o Fixtures that ship without lamps are tested with lamp model indicated on packaging.
- Downlight retrofits with ANSI standard bases can be either integral or connected by wire leads.
- Cold cathode CFL's are classified the same as “hot” in that IES LM-9, LM-65 and LM-66 are applicable for both hot and cold cathode sources.
- Inseparable SSL luminaires may be “directional” and are exempt from driver replaceability requirements.
- Directional residential outdoor-wall mount, porch, and pendant luminaires are added to the post-mount luminaire section for directional luminaires. This means that LM-82 for non-directional is not required for these product types.
- With the publication of IES LM-82-12, references to Solid State Luminaires V1.3 are removed.

### Conclusions

Certification for standards is an absolutely necessary process, whether it is for safety issues or for quality criteria. Customer sensitivity for quality criteria has improved significantly within the last few years. The internet and media have made the market more transparent. Users’ demand to be able to evaluate product quality and labels simply from independent organizations or government agencies are welcome tools. This requires products to be certified and manufacturers to understand the workflow of the certification process. The introduction of LEDs and the claims for extreme longevity mean that some tests will require longer amounts of time. Unfortunately, the aging process cannot be sped up by simulation. Therefore the best option for a luminaire manufacturer is a reliable LED manufacturer that provides the time-critical LM-80 data. This can clearly speed up the Energy Star® Luminaires certification process. ■



## LUSTROUS® POWER LED

[www.telcona.com](http://www.telcona.com)

CORAL		13.5 Watt
		19.2V 700 mA
Color Temp.	CRI	Light output
2500 – 3250 k	85	1200 lm
3250 – 4750 k	80	1370 lm
4750 – 10 000 k	70	1550 lm

# TELCONA

BEST IN ELECTRONIC COMPONENTS

Telcona AG CH-8154 Oberglatt Tel. +41 (0)44 860 25 50



## THE FUTURE. ILLUMINATED.

### 4.21.13 – 4.25.13



[www.lightfair.com](http://www.lightfair.com)

# Optics Production Technology for Customizing LED Luminaires

Siegfried Luger and Arno Grabher-Meyer from LED professional discuss future trends and challenges of the LED lighting business with Richard van de Vrie, CEO of LUXeXcel, a young company that is growing quickly. Van de Vrie owes much of his 25 years of experience in the lighting business to the family owned lighting company that he worked in.

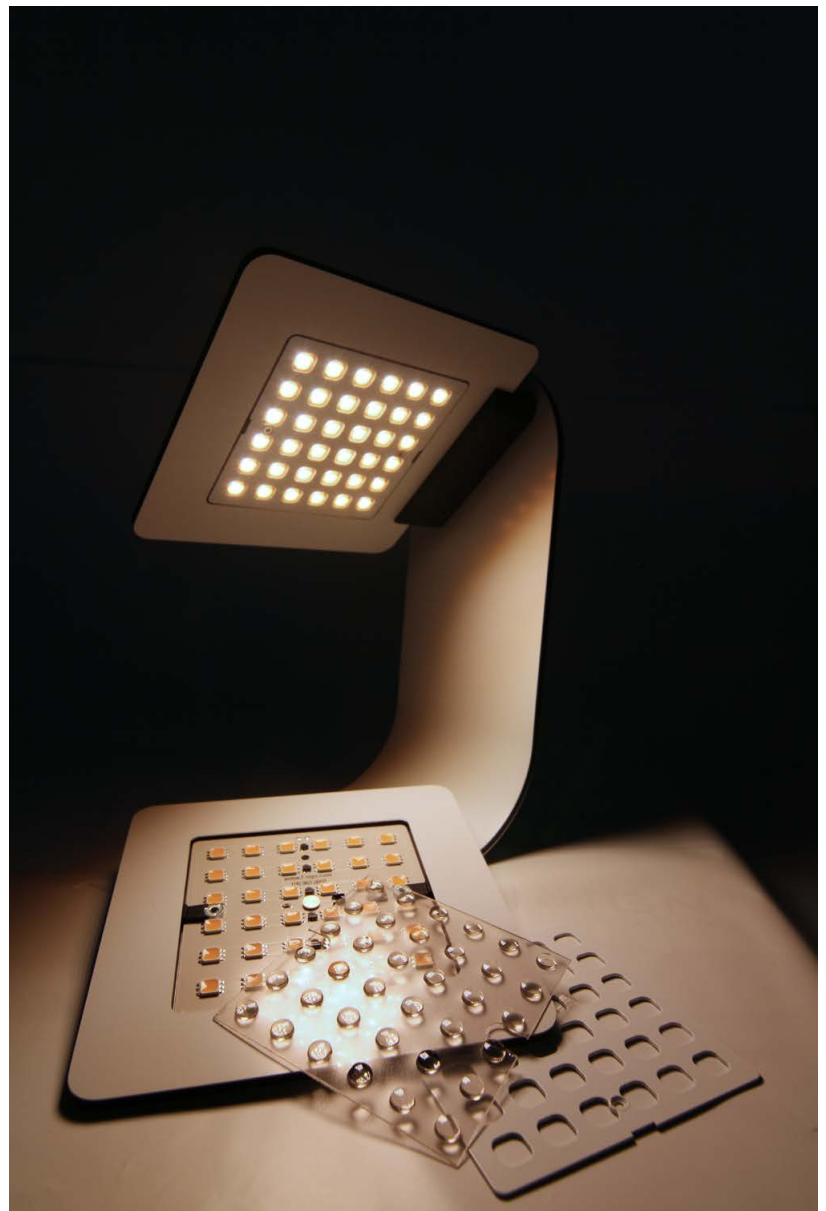
**LED professional:** In one of your articles it says that in your opinion, the introduction of LEDs has the lighting industry facing many new challenges. Can you explain why you think that?

**Richard van de Vrie:** As you know, before founding LUXeXcel I worked in a family owned company that provided OEM solutions to customers. With the introduction of LEDs the “digital era” began. This speed up development cycles so much that we were always busy developing new products. This, in turn, left us practically no time for our sales activities. That is why, for me, the speed of development cycles is a very important issue.

**LED professional:** Can you go into detail and tell us some of the reasons?

**Richard van de Vrie:** Of course. The lighting industry is used to relatively slow product development cycles - typically 9-12 months to introduce new products. Sales regularly has sufficient time and opportunities to respond to customer requests, but there are also requests for product variants that manufacturing can't deliver fast enough. That causes major internal friction.

R&D as well as Production struggle to keep up with the rapid pace of improvements in LED chips, LED modules and light engines which improve every 3, 6 or 12 months. The customers want to use state-of-the-art



**Figure 1:** FSIGN's one.LED product series was one of the first products that took advantage of the printoptical technology

LED chips, but fixture product development cycles are too slow to keep pace, not to mention the request for product variations.

**LED professional:** Is this perception valid for all technology fields or do you see differences?

**Richard van de Vrie:** To a certain degree, this is true for all technologies. However, during my time in the OEM business we identified optics as being one of the most critical components, if not the most critical one.

Optics brings about a significant drain on company profits due to high inventories and frequent write-offs.

The optics is specific to the LED module or light engine that was chosen when the optics was designed. For any one fixture, if you don't change the optics, the purchasers can only buy from the one LED vendor that the optics was designed for. That leaves little room for price negotiation.

**LED professional:** In that case, why not change both the light engine and optics at the same time?

**Richard van de Vrie:** The simple reason is that optics is costly. Injection molding tooling is very costly, and there are a minimum number of order commitments necessary to pay these costs. This requires more certainty in forecasting than is possible. No one can be sure which fixtures will be well received at a trade show. Having to order, for instance, a minimum of 50,000 pieces before customers and distributors have seen a working fixture, severely limits risk-taking in new product introductions.

**LED professional:** The word product is the key word here. Can you identify the key factors and key components for successful product generation?

**Richard van de Vrie:** Assuming that the product satisfies the preconditioned requirements for application and quality, there are three main points that I see. The first one is speed: Faster product introductions and faster adaptation to changing customer needs and improved LED chips or modules are crucial.

The second point is reduced inventories with just-in-time production and reduced product development costs. This means that fixture designers can afford to try more product variations.

The third one is developing a higher margin. More specialized and more diverse products - riding the long tail, as described and evaluated in Chris Anderson's book "The Long Tail" [1].

**LED professional:** What do you see as the top three future trends for LED lighting in general?

**Richard van de Vrie:** The first one is the remarkable and continuous trend of the decline of prices for LEDs, semiconductors in general, and electronics components. At the same time there is an increase of attention being paid to optics as the main driver of cost. In addition, optics is significant for product differentiation, which is my second trend: Novel beam patterns, even illumination, shaped to fit the application perfectly, measuring performance not by gross efficiency but by how well the lumens are directed to achieve the desired luminance levels where needed becomes more relevant. This option comes with the new light source, the LED.

The third trend I see is the adoption and exploitation of printoptical manufacturing to enable and accelerate the first two trends I mentioned.

**LED professional:** On a more technical level: 3D printing is not completely new or unique. On the

contrary, it is applied in many areas. One vision is to have many products manufactured using this technology. Some are even talking about do-it-yourself at home. Can you tell us what has to be taken into consideration when printing optics?

**Richard van de Vrie:** Optics needs to have smooth surfaces. This cannot be achieved with an ordinary 3D printing process where the structure is printed layer by layer. In contrast to that method our process is based on fluent dynamics. That means that we control the size of each droplet individually and the curing process is also adjusted and precisely controlled to guarantee a smooth surface. I just can recommend you to read also the interview with GE's CEO Jeff Immelt about "how additive manufacturing will change manufacturing" on 3D printing at 3DPrinting.com.

**LED professional:** How important is the resin used for the outcome?

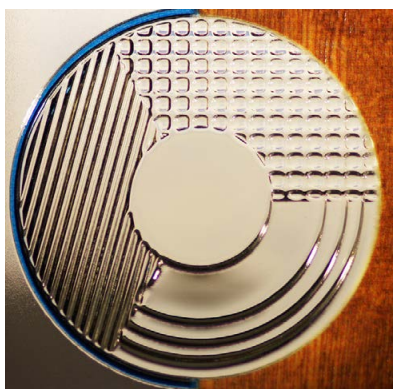
**Richard van de Vrie:** Very. The properties of the material are crucial for the result. Furthermore the transparent material used has to be durable. It has to fulfill all the requirements of optical materials that are used in conventional optics manufacturing like UV resistance, temperature stability and chemical stability.

And don't forget that the process has to be economical. That means it has to be fast. Therefore we use fast industrial printers that allow mass production and not just rapid prototyping.

The process we use is identical for rapid prototyping and for volume production. We use the same materials, the same equipment, the same process and get the same result. This means that when a prototype is satisfactory it literally only takes a few minutes for transition into volume production.

**LED professional:** So what you're saying is that it doesn't matter for LUXeXceL whether a single prototype is needed or thousands of lenses! That brings up the question of speed. How fast is your process?

**Figure 2:** Printoptical technology allows a designer to easily mix different structures, colors and patterns. They are virtually only limited by their own imagination



**Richard van de Vrie:** That strongly depends. Lens type, accuracy, thickness and costs have a big influence. Right now we are customizing different standard industry printers for these tasks. If we take one of our standard products as an example, I can tell you that with our current printer we can manufacture 600,000 to 700,000 pieces per year. Now we have 3 printers. If we require more printers to satisfy the demands, we can quickly and easily add new printers.

**LED professional:** On an even deeper technical level, over the past few years the maximum possible product height has been increasing continuously. What are the current restrictions for optics design? What does an optics designer have to know and understand?

**Richard van de Vrie:** While we are able to manufacture single optics and pre-assembled one-piece arrays of up to several square meters in area, today industrial production limits the thickness to 2mm on each side. We are already exceeding this limit in R&D projects and our target is to increase thicknesses to several centimeters. This would also be for industrial purposes where taller TIR optics are

desirable. We are rapidly getting closer to that goal and hope that we'll be able to offer it commercially sometime in 2013.

**LED professional:** Another parameter is thermal resilience. Can you tell us a little about that?

**Richard van de Vrie:** Currently our material is on par with PMMA, which is sufficient for many applications.

**LED professional:** Can you give us an idea about other improvements you have in mind?

**Richard van de Vrie:** There are a number of improvements that we are working on. Materials for example: We have improved and are steadily improving materials to achieve better clarity, better suitability for outdoor applications, higher temperature resistance or for combining multiple materials with, for instance, different refraction indices.

We have already significantly increased precision and are expecting to improve it even further this year. We want to go beyond lighting requirements and meet the requirements for general optics applications.

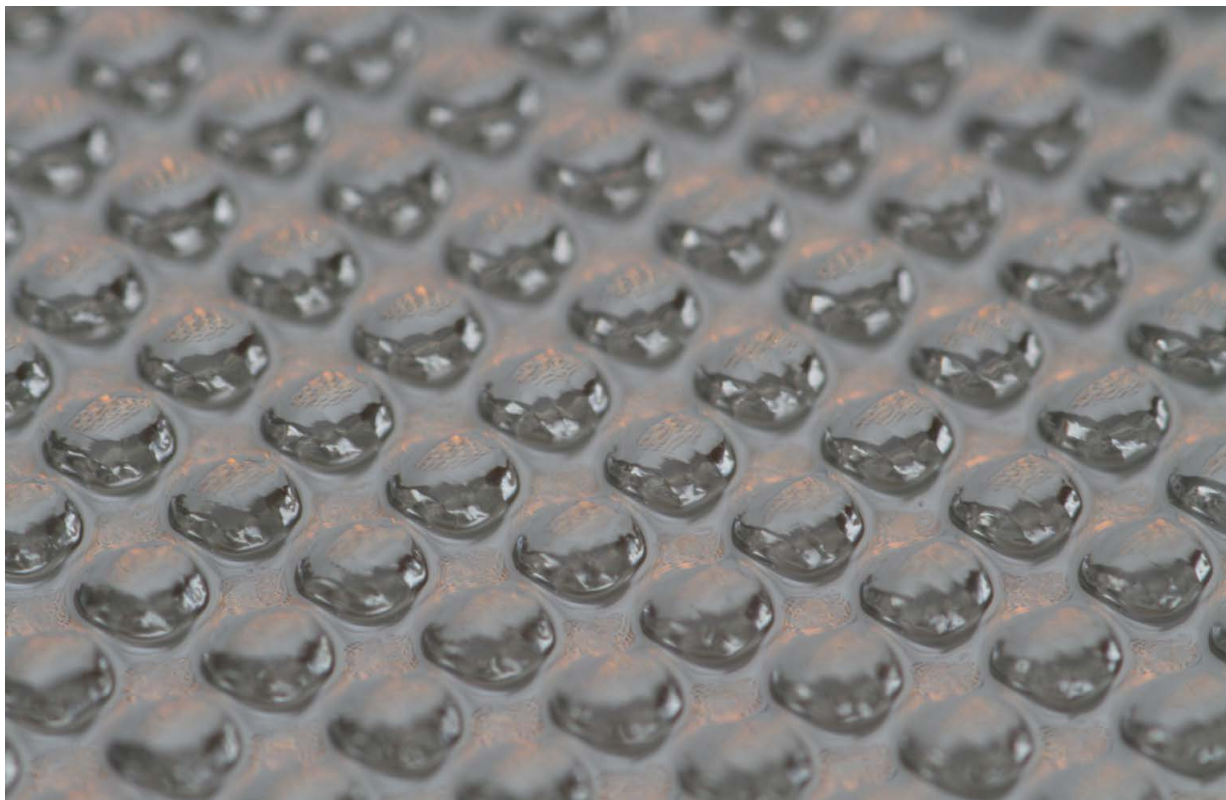
In this context I want to mention two other important points. One is color – we can do full color printed elements today but we are also continuing to improve capacity for designers to include color in their designs. We have recently introduced custom-mixed, “tinted” polymer inks that allow us to produce optics in any hue needed. And this is just the beginning!

Another thing we are working on is the design tools. Over time we will bring a broad range of flexible parametric reference designs online. These can be readily adapted to meet a customer's requirements at a much lower cost and much sooner than can be achieved by a manual custom design.

**LED professional:** It seems that you are eliminating restrictions very quickly, but will there still be limitations in the future? If so, what will they be?

**Richard van de Vrie:** There are no limits in sight. Every time we think we are at a limit we find a new way to push further. Therefore I am convinced that the main limit is imagination. We hope to see our new process being used to encourage creative thinking in order

**Figure 3:** Printing accuracy and smooth surfaces are constantly being improved to the point where they will soon satisfy the most demanding applications for general optics production. The latest samples of micro-structure optics are very convincing



**Figure 4:** Linear LED lighting is used in various situations. It is therefore useful to have optics with varying light distribution available



to design extraordinary new products, and not just as a new way to produce the same old designs.

**LED professional:** Your technology sounds very interesting, indeed. Are you worried about other companies challenging your approach or offering similar products and services? How are you protecting your business? What is your patent strategy?

**Richard van de Vrie:** We have a very good patent circle but right now we are developing at such a fast pace that we are confident of staying ahead of other companies - even if someone tries to copy us. The fact is; we are currently the only company capable of this technology.

**LED professional:** What else is necessary if a customer wants to start using 3D printing technology?

**Richard van de Vrie:** Anyone can start using 3D printed optics immediately because we offer manufacturing as a service. - That is what most customers are used to. They are accustomed to selecting optics and buying it from a manufacturer. Most of our customers just send us their optic design in the form of a standard CAD file and place an order for a small quantity. When they see that our product is satisfactory they place follow-up orders for as many or as few as they need, without being required by us to make a large commitment that ties

up their capital and entails piling up inventory and the risk of write offs if sales are not as planned. And as the engine needs to be changed, just change the CAD file. Because we are the research partners of many software companies, our service is supported by different CAD and design software, for instance Autodesk, Solid Works or Photopia.

But LUXeXceL is also happy to provide design services or work with third party optics design firms to create a custom design to meet their requirements.

**LED professional:** Your business model seems to be based on providing manufacturing services. Have you also thought about selling the printers and related knowledge that allows the customer to manufacture themselves?

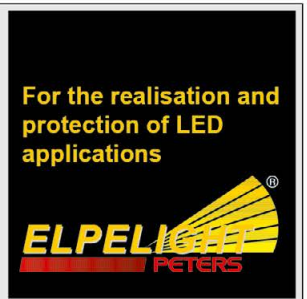
**Richard van de Vrie:** That is not something we are thinking about right now. The strategy we are using now reduces the risk of being copied. But even more importantly; our technology is still evolving. We don't want anything to cause development to slow down. Instead we are planning to open manufacturing and service centers all over the world, where we also hope to inspire innovation.



**ELPELIGHT® products for LED technology**

Light effects, such as diffusion or absorption for example under LEDs, can be avoided or indeed created with various lacquer systems for substrate coating. Casting resins or conformal coatings protect outdoor LED applications against environmental influences but also fulfil highest functional optical demands like very high transparency and UV light stability.

Please contact: [peters@peters.de](mailto:peters@peters.de), [www.peters.de](http://www.peters.de)



**20 Watt Buck/Boost Driver RBD-12 Supplies High Power LEDs**

When driven from batteries the number of individual LEDs within one string is limited by the battery voltage. The RBD-12 driver puts an end to such limitations. As soon as the input voltage drops below the threshold of the string it automatically switches into "boost" mode and generates a constant current of either 350 or 500mA at output voltages up to a maximum of 40VDC. The RBD-12 can drive up to 12 LEDs in one string from input voltages as low as 8VDC. The operational temperature range is up to -40°C to +75°C without derating. The drivers are EN/UL60950-1 certified and carry a 5 year warranty.





## Richard van de Vrie

Richard van de Vrie founded the LUXeXcel Group and holds the position of Chief Executive Officer.

He is a lighting industry veteran with more than 25 years experience through his roles as Chief Executive Officer of Lighting Partner BV and VP of Sylvania Lighting International and Lighting Science Group Corporation.

He has held various positions, including sales management, business development, brand positioning / marketing, building global platforms, launching new collections and global brands. Mr. van de Vrie was also co-founder of Eyeleds, an internationally recognized brand.

**LED professional:** Where do you see opportunities to inspire innovation with your printoptical 3D technology and help customers set trends? What is your vision of lighting?

**Richard van de Vrie:** I foresee the same trend that is happening on many markets, today. 3D Printing will not only change the way manufacturing is done but it will also enable lighting companies to customize fixtures per project or application.

**LED professional:** Could you give us an example of what you mean?

**Richard van de Vrie:** Yes, of course. One of our first products was lens arrays for our client, F-Sign. We adapted light distribution angles with little effort from 120° to 90°, 60° and finally even 76°, but that is not the whole story. This is not only possible with arrays, but also for freeform optics. In fact, it will soon become possible to customize every single fixture.

Street-lighting is maybe the best example: Today, I see a lot of poor light distribution; gardens are lit up and light shines into bedrooms that are close to the fixtures. Why not design the right optic for every fixture delivering the required light distribution for the place where it will be installed?

Besides that, outdoor fixtures can be improved helping to keep the sky dark by creating 100% customized light distribution. Square pictures in a museum can be lit up with a matching square beam. The ability to create a combination of optic and exact requested color filter will improve the offers for shop and food lighting.

**LED professional:** What does all that mean to the industry?

**Richard van de Vrie:** To be concise, the LED lighting industry needs to meet the demands of the market. With LEDs and advanced, digital technologies this can happen on a level never before seen. More and more professional lighting companies

share this opinion and have successfully started special project teams like OMS, Trilux and RZB. However, the number of both lighting fixture designers and light architects will have to increase if these demands are to be met.

**LED professional:** To wrap the interview up, could you give us your personal opinion regarding other lighting technologies and traditional light sources? How do you see other lighting technologies? Do you expect traditional light sources to disappear completely?

**Richard van de Vrie:** A lot people still need to understand that the lighting industry has also entered the digital age. The new possibilities that the digital process offers need to be accepted, adapted and understood. In my opinion, there is a great future for those technologies that enable design flexibility. Quick product introductions and modifications will help to increase the profits and revenues of lighting manufacturers and will address the increasing requests for customization. Here, I think LEDs have the highest potential.

I also expect that due to the change of market volume and the focus of R&D, high intensity discharge lamps will become more expensive to manufacture while LEDs will become cheaper. The higher lumen performance of LEDs will rapidly make them more popular. I expect fluorescent lamps, especially CFLs to gradually disappear as people become more aware of the fact that mercury causes environmental problems. I imagine that fluorescent lamps will soon be completely banned by governments. For existing light sources as well as new lighting technologies, like OLEDs, customization will be crucial for survival on the market.

**LED professional:** Mr. Van de Vrie, thank you for sharing your insights with us.

**Richard van de Vrie:** My pleasure. ■

### References:

[1] Anderson, Chris (2006). The Long Tail: Why the Future of Business Is Selling Less of More. New York: Hyperion. ISBN 1-4013-0237-8



The Intertek logo is a dark blue rounded rectangle with the word "Intertek" in white sans-serif font.

Valued Quality. Delivered.

A large green maze is set against a dramatic sky with golden light rays breaking through clouds. A person in a blue shirt stands at the entrance of a glowing blue path that winds through the maze. Other people in red shirts are seen at various points in the maze, suggesting a journey or a search for a solution.

# Let Intertek clear a path<sup>TM</sup> for your next innovation

**Get to market with  
greater speed and simplicity.**

Before your next bright idea can enter markets around the world, you've got a choice to make. Will testing and certification be convoluted, costly and time-consuming? Or will it be painless and efficient?

Every year, thousands of manufacturers partner with Intertek to ensure their innovations are successful. From safety and performance to energy efficiency and more, we offer the most comprehensive array of testing, inspection and certification services. Our ETL Mark is the fastest-growing safety certification in North America because we're committed to exceptional service, quality and fast turnaround. And our global network of laboratories provides local expertise and project management.



Visit [www.intertek.com/lighting](http://www.intertek.com/lighting) or call 800-WORLDFLAB today to learn how we remove the barriers and get you to market faster.

# How Silicones are Evolving to Meet the Growing Needs of the LED Lighting Industry

There are different materials for optics in lighting applications. The lighting application engineers François de Buyl, Martijn Beukema and Kevin van Tiggelen from Dow Corning are convinced that silicone's unique qualities help to expand options in the design and molding of LED packaging components, as well as components for lamp and luminaire applications.

The number of LED applications benefiting from the unique properties and diversity of silicone polymer chemistry continues to increase, and the material is helping to overcome new and existing technical challenges. For instance, the demand for LED lighting applications with ever increasing light flux and thermal loads is particularly challenging. New lamp and luminaire architectures, such as optical lenses, remote phosphor or white reflector designs, may not be compatible with materials historically used by lighting manufacturers. As a consequence, there is renewed interest from LED lighting companies in silicone-based materials that have not traditionally been considered for broad use in lighting applications. These include consumer and industrial lamps and luminaires, signage, street and architectural lighting (both for indoor and outdoor applications), entertainment lighting, healthcare and hospitality, and automotive headlamps and interiors. Overall the features of silicone materials can help the design and molding of components that can meet the increasingly challenging demands of these applications.

## Unique Properties for Photonics Applications

Silicones actually display the unusual combination of an inorganic chain similar to silicates, which is often associated with high surface energy. But they incorporate side methyl groups that are conversely very organic, and thus exhibit low surface energy. The Si-O bonds of silicone are strongly polarized and, without protection, should lead to strong intermolecular interactions. Methyl groups weakly interact with each other, so they effectively shield the main molecular chain. This is further facilitated by the absence of side groups at the oxygen atom, which results in the high flexibility of the siloxane chain. This open molecular structure also explains the lower barrier to rotation around the Si-O bond. In more practical terms, this means silicone's polydimethylsiloxane chain can easily adopt many shapes for easier processing and molding.

Silicones' low intermolecular interactions and high free volume compared to hydrocarbons results in other physical characteristics, such as a low glass transition temperature ( $T_g$ ) of 146K (-127°C), naturally high flexibility, good vibration absorption characteristics as well as high impact resistance. Despite the high solubility and high diffusion coefficient of gases such as oxygen, nitrogen or water

vapor, silicone resists wetting due to its very low surface tension. Therefore with their low moisture uptake and ability to withstand harsh environmental effects, conventional silicones are already frequently used by the electronics industry to protect fragile components against damage.

Although transparent liquid silicone rubber grades already exist and are widely used in LED fabrication and packaging applications, moldable silicones recently developed by Dow Corning represent a more advanced material engineered expressly for LED lamps and luminaires applications and, in addition, they deliver many of the above characteristics.

Compared to many organic materials, the chemical backbone of silicones makes them particularly well-suited to manage the increasingly high temperatures of today's and tomorrow's LED lighting systems.

In addition, the lower electronegativity of silicone (1.8) vs. C (2.5) leads to a very polarized Si-O bond that is highly ionic and exhibits a large bond energy, 452 kJ/mol (108 kcal/mol). By comparison, the Si-C bond has a bond energy of ca. 318 kJ/mol (76 kcal/mol), which is slightly lower than a C-C bond, while the Si-Si bond is weak, 193 kJ/mol (46.4 kcal/mol). These values explain the stability against heat

**Table 1:**  
Bulk material properties: glass, silicone, polycarbonate (PC) and polymethyl-methacrylate (PMMA)

Material / Properties	Glass	Silicone (Dimethyl)	PC	PMMA
Form	Solid	Liquid	Solid	Solid
Procession Temp [°C]	1500	20	280-320	250
Molding Temp [°C]	600 (tin bath)	150	80	80
Refractive Index	1.52	1.42 [Dimethyl] 1.52 [Phenyl-Methyl]	1.58	1.49
Light Transmission	> 95%	94%	88-90%	93%
Max. Service Temp [°C]	> 200	150	120	90
Vicat softening Temp [°C]	NA	NA	144	108
Glass Transition Temp, T <sub>g</sub> [°C]	+600	-125	+145	+120
SG [g/cm <sup>3</sup> ]	2.5	1.02	1.2	1.2
C TE [ppm/°C]	10	275	65	72

and ultraviolet (UV) of the Si-O-Si dimethylsiloxane backbone used in moldable silicones. The presence of groups other than methyl along the chain leads to a reduction of thermal stability. But with the substitution with phenyl groups, physical properties such as refractive index and gas permeability can be modified, while stability under heat remains excellent.

In summary, the comparative properties shown in Table 1 clearly illustrate differences in key bulk materials characteristics for silicones, glass and plastics such as polycarbonate (PC) and acrylic (PMMA), which represent the materials most widely used in optics at the present time.

### Silicones' Processing Advantages

From a material processing standpoint, moldable silicones exhibit low viscosity before cure, enabling

them to be molded more easily into complex shapes and thinner wall configurations than either organic polymers or glass. This offers new design options for secondary optics, light pipes, light guides, white reflecting parts and remote phosphor components as shown in Figure 1.

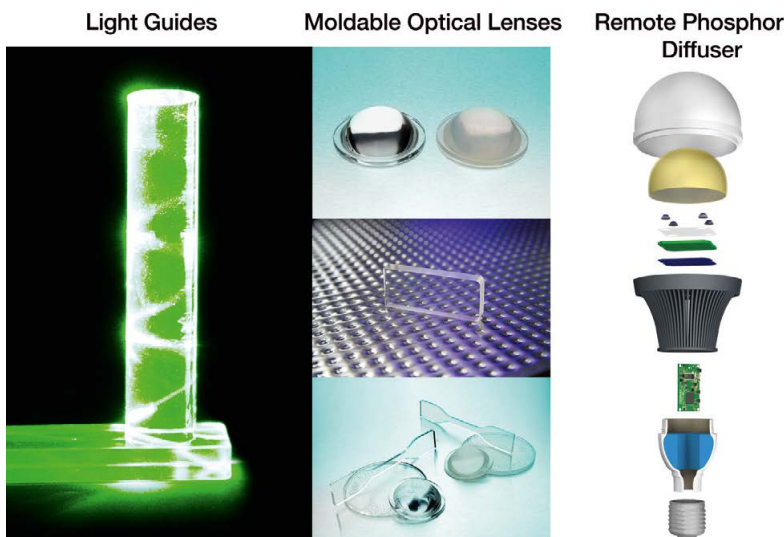
Energy consumption used for molding silicone parts can be significantly less when considering the melting temperature of glass or plastics (Table 1) that are solid at room temperature. Unlike other materials, moldable silicones are a liquid at room temperature and only need moderate molding temperatures to obtain solid optic parts. In addition, silicones in general are less brittle than plastics, and do not suffer environmental stress cracking like polycarbonate does, which reduces the challenge of fabricating parts that adjoin thin- and thick-wall sections.

Silicone-based components can be fabricated using a variety of techniques, including injection molding, casting/ cavity molding and others. Like conventional silicones, optical-grade silicones are well-suited to precision molding applications. Before cure, the viscosity of silicones decreases as heat increases. This allows silicone resins to be injected into a mold at lower pressures than what is typical for other materials, while still achieving good flow and reproduction. For example, their low viscosity enables replication of micrometer-sized features on a lens surface that, in turn, offers advantages in enhancing, focusing or directing light output.

Shrinkage, another familiar challenge for plastics, is less of a problem for moldable silicones that, unlike plastics, need not be cooled in the mold for long periods in order to prevent warping. This helps reduce cycle time – particularly for large parts – which is important since the length of time that a part must remain in the machine can represent an important percentage of its total cost, depending on the mold, optical part design and process factors mentioned above. In addition, the comparatively low shrinkage of moldable silicones helps minimize or prevent warping in components that integrate straight sections, such as the back of semispherical optics.

Combined, all of these factors signify that moldable silicones offer the opportunity to reduce manufacturing costs and cycle times in injection molding, and potentially reduce system costs for LED-illuminated lamps and luminaires.

**Figure 1:**  
Examples of light guides, lenses, diffuser and remote phosphor made with moldable silicone



### Thermal Stability Drives Optical Performance

Properties such as refractive index, coefficient of thermal expansion (CTE) and light transmission are all important to consider to ensure that materials deliver optimal value in lighting applications. Additional properties, such as maximum service temperature and resistance to degradation from ultraviolet (UV) radiation exposure are important to ensure long life of LED modules – especially those exposed to harsh environmental conditions and high lumen density.

Moldable silicones particularly shine in high-heat applications. As a class of materials, they withstand temperatures of 150°C and higher without significant loss of optical or mechanical performance. These qualities are becoming more attractive as LED sources increasingly deliver more intense white light from comparatively smaller package sizes, and as customers seek smaller lamps and luminaires with higher luminous flux.

Indeed, as lumen densities increase, the package temperatures within today’s high-brightness LEDs are already reaching as high as 150°C. This poses challenges for conventional epoxy encapsulants used to seal LED packages. But it is also raising challenges for traditional secondary optics materials such as polycarbonate (PC) and acrylics (PMMA). In general, the optical quality of these plastic materials declines over time at temperatures above 120°C and 90°C, respectively. Polycarbonate is prone to significant photodegradation and hence yellowing discoloration when exposed to blue LED light radiation and heat. Similar declines in performance occur for epoxies at temperatures above 150°C.

The higher temperatures demanded in next-generation LED designs can cause traditional optical materials used in LED lighting systems to yellow with age. This diminishes the total system light output, and can have a profound impact on lumen maintenance and

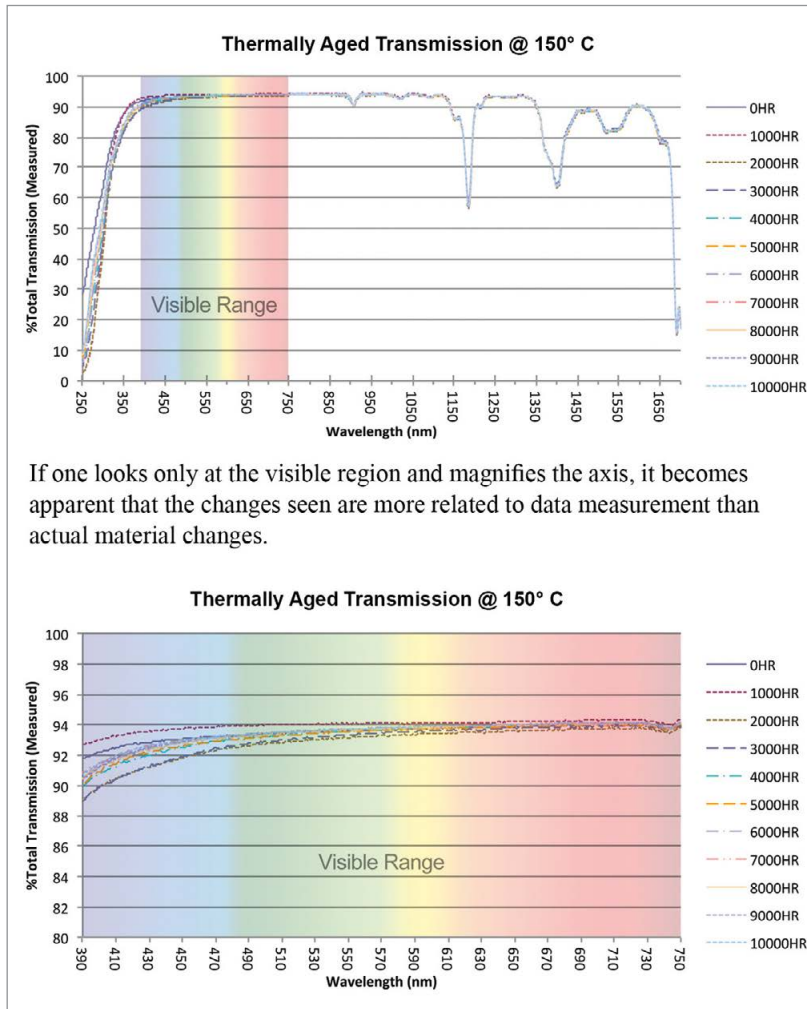
efficiency. Specifically, it can push the 80 percent lumen output expected for LEDs below acceptable levels earlier than the expected 50,000 hours of an LED light source’s useful lifetime. In addition, yellowing adversely changes an LED’s color temperature over time, which is unacceptable to designers and end-users alike.

In comparison to these materials, moldable silicones exhibit excellent optical stability and transparency after prolonged exposure to temperatures upwards of 150°C, with comparatively little or no yellowing and greater reliability across the visible spectrum. Notably, thermal aging tests performed by Dow Corning in an air-circulating oven at 150°C for up to 10,000 hours demonstrated that the high optical transmission of moldable silicones remained steady – ranging from 90 to almost 95 percent in the visible spectrum (Figure 2). Moldable silicones also maintained high performance for other optical qualities during aging under high heat, including reflection, low haze and stable refractive index. Actually, light reflection and haze of optical grade moldable silicone can be readily controlled by molding lens parts of various surface finishes. Indeed, type A1 “mirror polish” surface finish according to SPI specified surface treatment will provide molded silicone part with low rate of diffused light, while for instance, type D3 “sand blasted” surface finish will provide molded silicone part with high rate of diffused light. However, in both cases, light transmission will remain at ca. 94 percent.

In addition, optical grade moldable silicone with 94 percent light transmission measured on a 3 mm thickness specimen is showing quite low rate of light absorption as the thickness of the optical path is increasing. Indeed, measurements were showing that 90 percent light transmission is maintained for a thickness of ca. 40 mm.

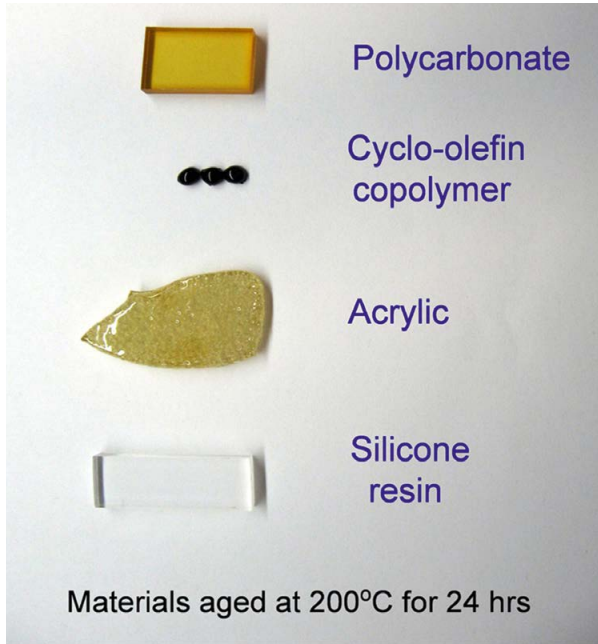
In related tests, moldable silicones were thermally aged for 24 hours at 200°C, and further demonstrated comparably high thermal and optical stability against conventional

**Figure 2:** Light transmission of moldable silicone (3 mm thickness) after heat aging at 150°C up to 10,000 hours



If one looks only at the visible region and magnifies the axis, it becomes apparent that the changes seen are more related to data measurement than actual material changes.

**Figure 3:** Comparative heat aging of polycarbonate, cyclo-olefin copolymer, acrylic and silicone resins after 24 hours at 200°C



materials, such as PC, acrylic and epoxy. In contrast, incumbent organic materials exposed to identical conditions began to exhibit significant yellowing as temperatures exceeded 125°C (Figure 3).

**Design Optics with Silicone**

Again, from an optics design standpoint, refractive index, CTE and thermo-optic coefficient (TOC) are key parameters to consider when light emitted by an LED light source needs to be manipulated by a secondary optical element. A straightforward way to estimate the transfer of radiation from a light source to a receiver is to utilize the law of “conservation of étendue”. The étendue (U) is given by the following equation:

$$U = \pi n^2 A \sin^2(\Theta)$$

where n is the refractive index of the material; A, the output surface area of the optical element (or of the emitting area in case of the light source); and  $\Theta$ , the viewing angle. This is illustrated schematically in Figure 4 for an LED and a collimator optical element.

To get a better understanding of what the viewing angle does with the light, it is useful to work with the illuminance, which expresses the light flux per unit area.

The relation between beam angle and illuminance is the following:

$$Illuminance = \frac{(Luminous\ flux)}{(\pi L^2 \tan^2\Theta)}$$

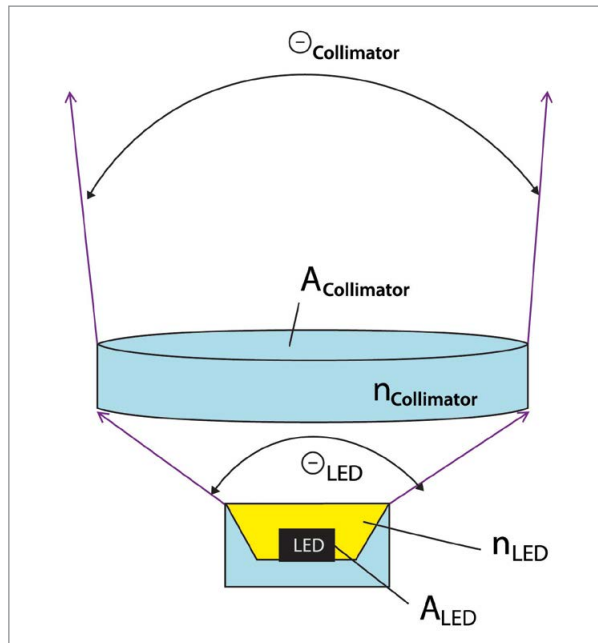
where L is the distance between the light source and the illuminated surface.

The refractive index, CTE and TOC vary between materials used to collimate light, and it is important to understand how these variables impact beam angle and therefore illuminance for a given lens dimension. Put in another way, if a similar illuminance is preferred then the output surface area (A) of a given lens needs to be modified to adjust for the material's refractive index. If temperature is an issue, then also the CTE and TOC need to be considered.

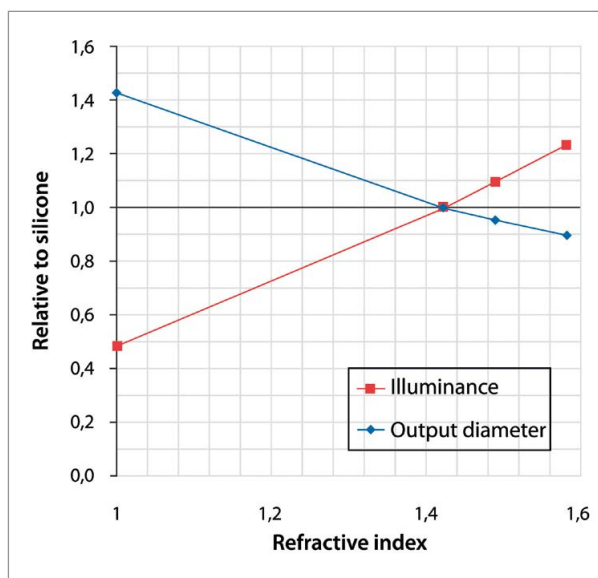
The above equations help to calculate changes in the relative output diameter as a function of viewing angle for lenses made of silicone, polycarbonate and acrylic, or for a reflecting surface in air.

Plots in Figure 5 and values in Table 2 illustrate that differences in a material's refractive index do not dramatically change the diameter of the lens for keeping illuminance constant, assuming there is no loss of light due to internal reflection or absorption. If a silicone collimator with fixed output surface would be exchanged with PMMA or PC, the change in illuminance would be 10% and 24% respectively (Figure 5). However, if the purpose is to maintain the same illuminance level with

**Figure 4:** Diagram of an LED light source and collimator, illustrating refractive indices (n), output surface area (A) and viewing angle ( $\Theta$ )



**Figure 5:** a) Calculation of the relative illuminance (relative to silicone) as a function of the refractive index for a fixed output surface area of the collimator; b) Calculation of the relative output diameter of the collimator as a function of the refractive index for a reflector in air (RI=1.0), silicone (RI=1.424), PMMA (RI=1.491) and PC (RI=1.584)



**Table 2:**  
Examples of calculation of output diameter as a function of beam angle for a reflector in air (RI=1.0), silicone (RI=1.424), PMMA (RI=1.491) and PC (RI=1.584) for three beam angles values. The light source is a 1mm<sup>2</sup> LED die encapsulated in silicone with RI=1.424

Viewing angle	Reflector RI=1.0	Silicone RI=1.424	PMMA RI=1.491	PC RI=1.584
10	16	11.2	10.7	10.1
20	8	5.6	5.4	5.1
30	5.4	3.8	3.6	3.4

the silicone collimator, the output surface of a PMMA and PC lens would need to be decreased by only 4% and 10% (Figure 5).

Concerning thermal effects, the influence of factors such as CTE and TOC need to be considered to calculate the change in illuminance when using silicone, PMMA or PC. The formula for étendue including temperature dependence can be written as follow:

$$U = 2 n(T)^2 A(T) \sin^2(\Theta)$$

where n(T) and A(T) are the refractive index of the material and the output surface area, respectively, as function of temperature, and Θ the viewing angle. Both n(T) and A(T) depend on temperature (T) according to the following equations. Thus...

$$n(T) = n_0 + TOC \cdot \Delta T$$

$$A(T) = A_0 + CTE \cdot \Delta T$$

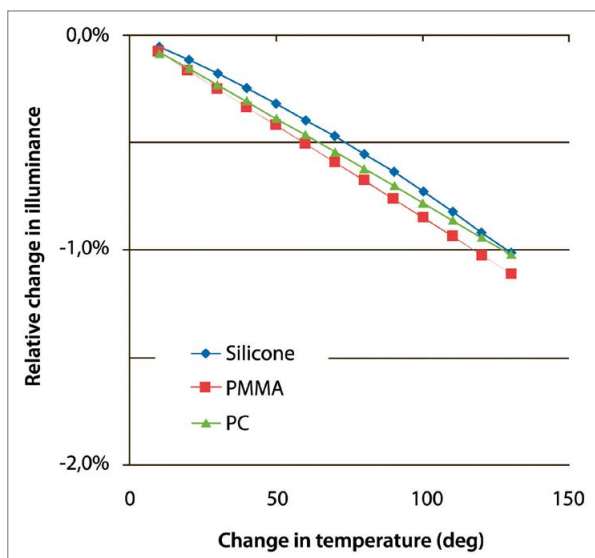
TOC values and CTE values for silicone, PMMA and PC are given in Table 3.

**Table 3:**  
CTE and TOC values for silicone, PMMA and PC

Material	CTE (ppm)	TOC (10 <sup>-4</sup> )
Silicone	275	-1.5 to -5.0
PMMA	72	-1.1
PC	65	-1.0

The TOC of silicone actually compensates the effect of CTE. Silicone has a high CTE that will increase the output surface of the optical element, thus increasing the illuminance. On the other hand silicone shows a large thermo optic

**Figure 6:**  
Plots of relative change in illuminance as a function of temperature increase for an initial viewing angle of 20 degrees (at room temperature). The TOC of silicone in the figure is estimated -3.10<sup>-4</sup>



coefficient compared with PMMA and PC, which will reduce the refractive index with increasing temperature, thus decreasing the illuminance. Depending on the value for TOC, the thermal behavior of silicone on the illuminance is comparable to that of PMMA and PC (see Figure 6). Typically the illuminance will slightly decrease (only ca. 1 percent at ca. 100°C) with temperature for all materials, i.e. silicone, PMMA and PC.

Despite a minor increase in the optic output diameter when using silicone against PMMA or PC (Table 2), there is therefore a similar behavior to be expected using silicone instead of PMMA and PC as temperature of the luminaire will increase when in service.

### Summary

In terms of performance, moldable optical silicones combine and often exceed the best qualities of both organic polymers and glass. As demand for LED lighting accelerates over the next decade, moldable optical silicone materials are positioned to play a major role in the development of new high-performing LED light sources, and could help expand design and processing options for LED lamps and luminaires. Their good thermal stability, moldability and mechanical properties offer benefits at virtually every stage of the LED value chain – solving challenges to sealing, protecting, adhering, and shaping light. With the addition of their attractive optical qualities, moldable silicones can address design issues such as diffusion and glare control, color temperature variation and performance over time. Moldable silicones further offer the potential to advance the adoption of LED lighting, drive down cost and help expand the technology into new markets, such as general and accent lighting for home, office and retail spaces, traffic lights and any other outdoor illumination, mobile devices and automotive interior lighting. Silicone-based LED lighting could especially benefit applications that require a cool touch and environmental toughness. ■



Signcomplex

We bring innovation and give impression



## Wi-Fi Controllable PlayLED™ set

Download the intelligent program  
and play dynamic colors with personal mobile device!  
Now compatible with iOS and Android system

### Compatible

DigiRibbon, normal RGB, normal brightness and CCT adjustable, Compatible monochrome

A set includes :

- a roll LED strip (5m)
- RJ-45 output cable (1m)
- Controller (1pcs)
- power adapter (1pcs)



www.signcomplex.com  
marketing@signcomplex.com  
phone:+86 755 2760 8650  
fax:+86 755 2760 8651

# The Influence of LED Emission Characteristics on the Efficiency of Lighting Systems

In general lighting, efficiency is the main focus. Under specific operation conditions, the main issue appears to be luminous flux. Dr. Roland Schulz, application engineer in the Solid State Lighting division at Osram Opto Semiconductor, takes a deeper look at the influence of LED radiation characteristics.

LED is not always LED. Some luminaire designers had to learn that the hard way. But what makes the difference in an application? Dr. Roland Schulz, application engineer in the Solid State Lighting division at Osram Opto, answers this question and explains the reasons.

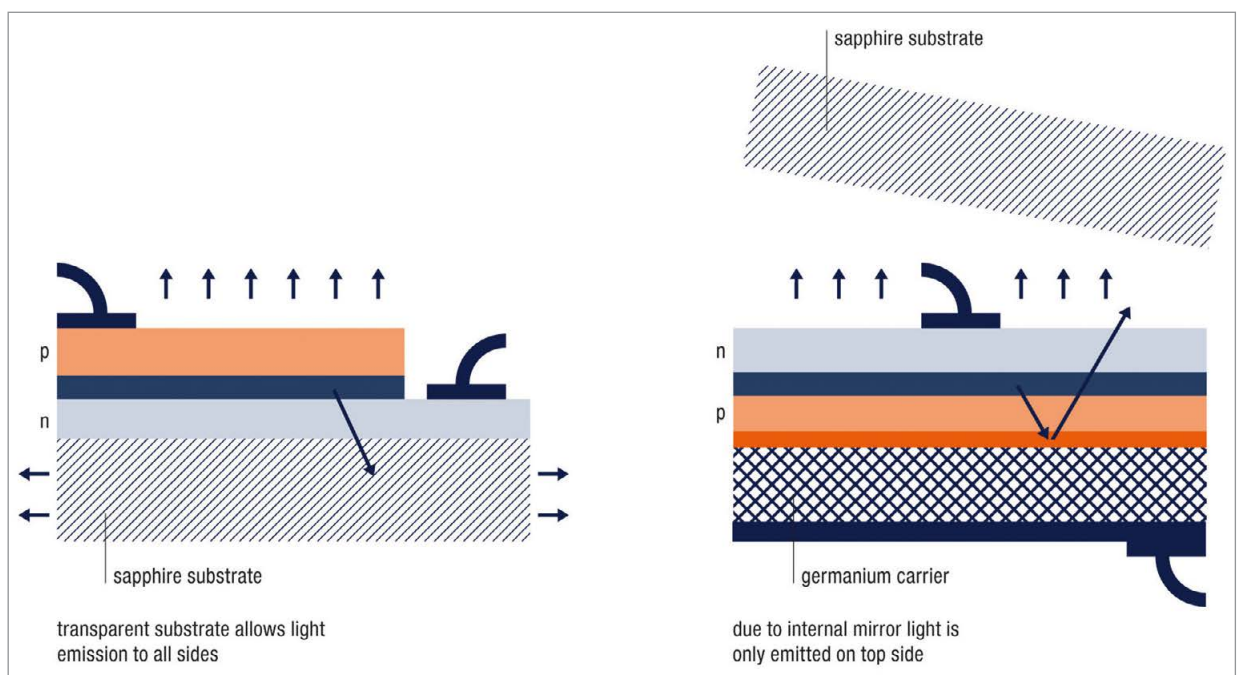
As LEDs are becoming more and more widespread for general illumination there is an increasing variety of LED chips and packages. Customers are looking for high efficiency coupled with long life.

Designers of lamps and luminaires want the greatest possible freedom to interpret the requirements of customers. It is therefore more important than ever to select the right light source for the particular application. The emission behavior of the LED is a major factor in this respect.

Lamp and luminaire designers get their initial information from the data sheets for the LEDs. These data sheets provide information on the luminous flux and power consumption under different operating conditions.

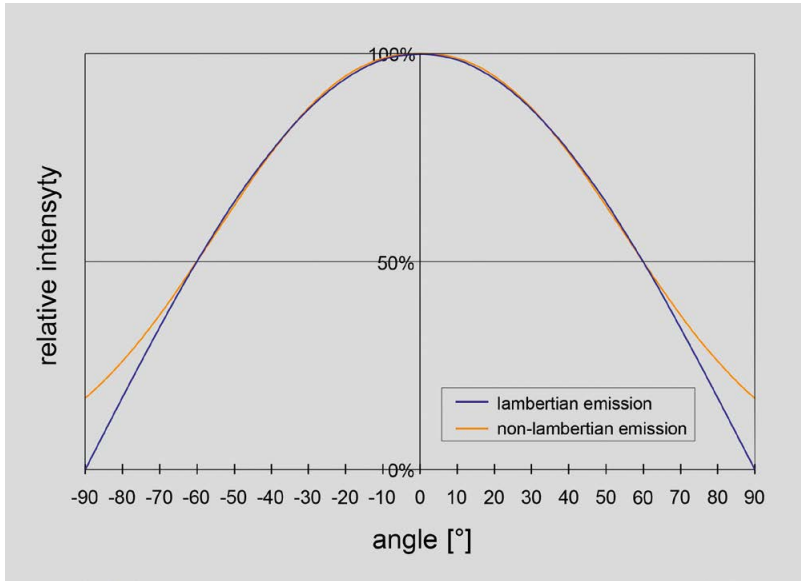
A luminous intensity diagram shows the emission characteristics of the LED at different angles of emission. The half width indicates the emission angle at which the luminous intensity is 50 percent of the maximum value. This information is not sufficient, however, as the basis for selecting an LED because the half width specifies only a single point along the LED emission curve, and the luminous intensity distribution is not an accurate measure of the brightness of the LED in a luminaire.

**Figure 1:**  
Structure of volume emitting and surface emitting LED chips

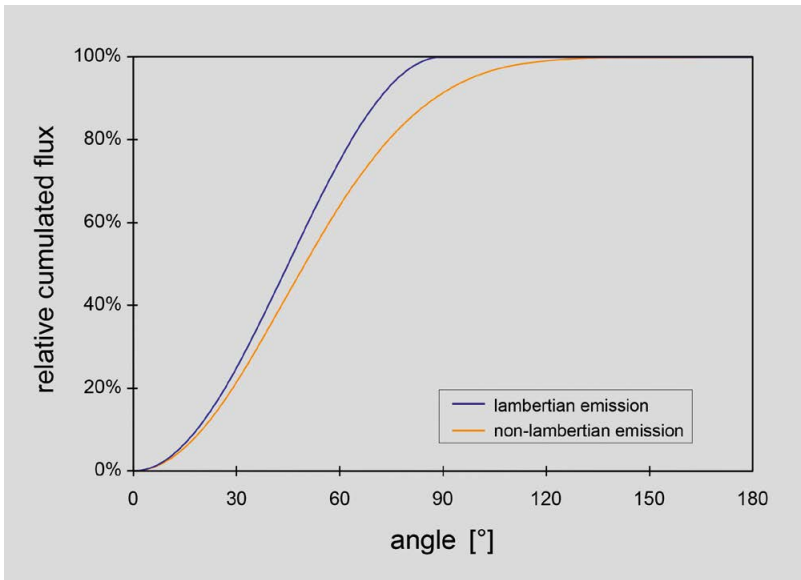




**Figure 2:**  
Emission characteristics for two different LEDs with the same half width of 120°



**Figure 3:**  
Cumulative luminous flux for the two LEDs



### Influence of Chip Technology on the Emission Characteristics

If we take a closer look at the emission characteristics of various LEDs we can certainly find differences that have an impact on the efficiency of a lighting system. A comparison of the luminous intensity diagrams of different LEDs shows that some light sources still have high luminous intensity at an angle of 90 degrees while others emit light only in the forward direction. The reason for this lies to a certain extent in the chip technology. There are two different ways in which LED chips are fabricated (Figure 1). In both cases the light emitting layer, the p-n junction, is grown on a substrate – usually sapphire. If LED chips are manufactured directly from this substrate one gets a volume emitter.

The light produced at the p-n junction is emitted in all directions. It is emitted not only to the half-space in front of the LED but also into different angles. External optics, however, can only use the light emitted in the front half-space. The surface emitting LED chip was developed to achieve emission only in the desired direction. A reflector is attached to the light emitting layer and both of these are attached to a new substrate, such as germanium. The original, and thicker, substrate is then removed. The reflector prevents the light produced at the p-n junction from being emitted into the substrate. The result is what is known as a surface emitter that emits light only in the front half-space of the LED with a lambertian emission curve. The maximum possible emission angle here is 90 degrees. What's more,

the conductivity of germanium is better than that of sapphire so the chip remains cooler during operation.

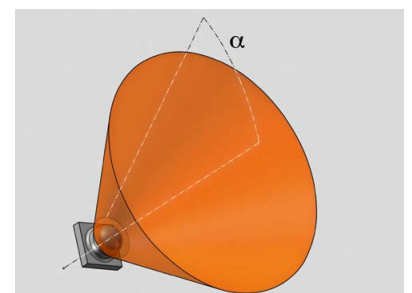
The differences between volume and surface emitters are even more noticeable when producing white light. White light is generated by using phosphors that convert blue light into longer wavelength spectral colors. In the case of surface emitters the converter material is generally attached as a thin layer (thickness about 50 μm). Even scattering within the layer does not result in significant light emission at angles greater than 90 degrees because the layer is so thin.

On volume emitters the converter material must surround the entire chip, which means that thin layers cannot be used. With typical chip heights of 100 to 150 μm, emission surfaces of 200 μm and more are easily generated, emitting white light over a wide range of angles. For the white-converted chip this results in light emission with a significant intensity at angles greater than 90 degrees.

### The Differences in Emission Characteristics

The brightness of an LED always relates to the entire luminous flux. In other words, including the light emitted at the side. The emission characteristics of two LEDs with the same half width of 120° may differ significantly (Figures 2 + 3). One LED has lambertian emission characteristics, while the other LED has emission characteristics that deviate from the lambertian curve. Both curves are almost identical at low angles but at more than 60° there are significant differences – despite the same value for the half width. These differences have an effect on the

**Figure 3:**  
The luminous flux within a cone with an opening angle of  $\alpha$  defines the cumulative luminous flux



usable luminous flux. The cumulative luminous flux provides the explanation (Figure 4). The cumulative luminous flux is the proportion of the luminous flux that is emitted within a cone with opening angle  $\alpha$ . The LED with lambertian emission characteristics emits all its light at angles less than

$90^\circ$ , whereas the LED with emission characteristics that deviate from the lambertian curve emits around 10 percent of its light at an angle greater than  $90^\circ$ , i.e. onto the substrate. At an angle of  $60^\circ$ , this type of LED already offers about 10% lower cumulative luminous flux.

### Emission Angles above $90^\circ$ Make it Difficult to Use the Light

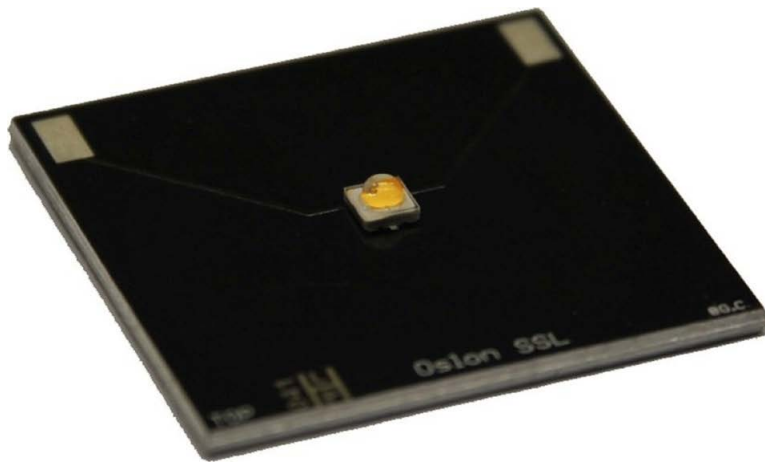
Light emitted at angles above  $90^\circ$  hits the board on which the LED is mounted (Figure 5). The light is scattered as a result. If the board is dark with low reflectivity there is a loss of light. This restricts the freedom of the luminaire designer considerably. It will get much more difficult to achieve a dark "off state" for luminaires without reducing their efficiency significantly.

There is also the benefit that the light emitted in the half-space in front of the LED can be directed almost anywhere by means of refractive or reflective optics. The light emitted in the half-space in the back of the LED is lost in most applications. TIR optics (TIR = Total Internal Reflection) use the properties of reflectors and lenses to enable compact optics. Normal TIR optics cannot use light emitted at an angle greater than  $90^\circ$  (Figure 6). To ensure total reflection with such LEDs the shape of the lens would have to be modified, particularly on the bottom side. Another option would be to mount such an LED deeper inside of the lens but this results in poorer thermal properties. Both options require a larger size of the lens and will unavoidably lead to higher costs.

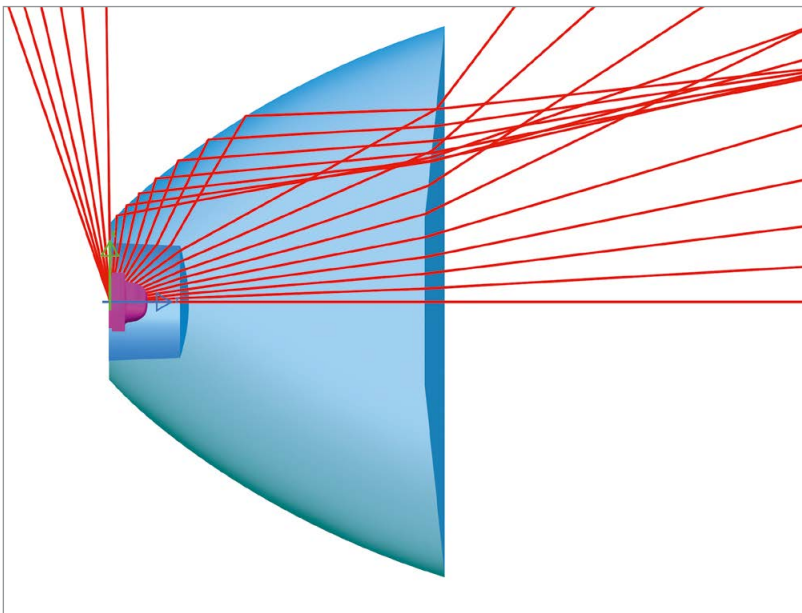
If LEDs are arranged in clusters, only the light emitted directly upwards is undisturbed (Figure 7). Depending on the spacing between the LEDs the light from one LED will hit its neighboring LED from a certain angle onwards and will be either reflected by the LED or refracted into the LED. LED packages with highly reflective coatings in the package will reduce losses to a minimum (Figure 8). Light emitted at angles above  $90^\circ$  will hit the side of the neighboring LED package, the LEDs solder joint or the board itself. Losses are inevitable here.

In all the above cases the effective brightness of the LED is reduced. Reduced luminous efficacy means that more LEDs are needed and system costs are higher. The price per lumen increases for the luminaire. As a consequence one needs to choose the right LEDs with the most appropriate

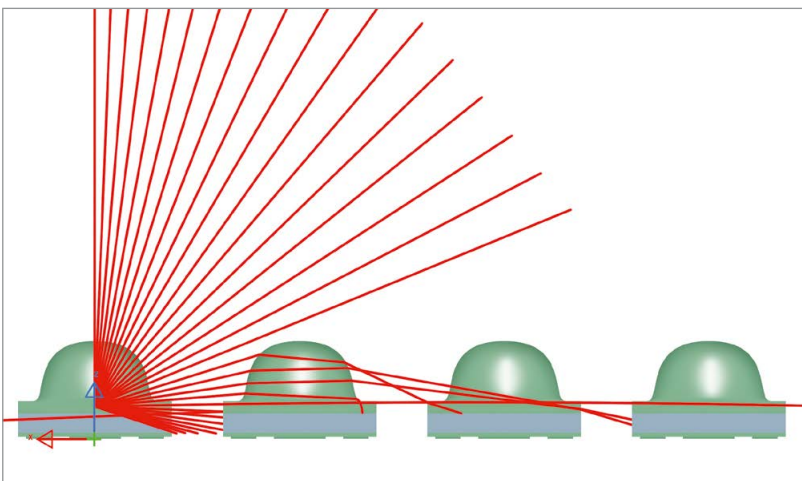
**Figure 5:**  
Mounted LED



**Figure 6:**  
LED with emission  $>90^\circ$  with a TIR lens



**Figure 7:**  
LED cluster with LEDs with an emission angle  $>90^\circ$





4W~7W  
7W~10W



# ET-1208 Series

# Edison Opto shines across the world

### Features

- High luminous Intensity and high efficiency
- Excellent performance and visibility
- Environmental friendly-RoHS compliance
- Fine CRI performance

### Typical applications

- MR16 / GU10
- Indoor / Residential Lighting
- Small Down Light
- Commercial Lighting

### EdiPower II (COB) Series

#### HR Series



9W/ 13W/ 24W/ 35W

#### HV Series



3W~12W

#### HM Series



8W~20W/ 20~60W

#### CA Series



3.5W~7W



### Headquarters:

• 4F, No.800, Chung-Cheng Rd., Chung-Ho Dist., New Taipei City, Taiwan 23586

T+ 886 2 82276996 F+ 886 2 82276997 [service@edison-opto.com.tw](mailto:service@edison-opto.com.tw)

• 1809 Excise Avenue, Suite 201, Ontario, California 91761 USA

T+ 1 909 947 0238 F+ 1 626 956 0754 [service@edisonopto-usa.com](mailto:service@edisonopto-usa.com) [www.edison-opto.com](http://www.edison-opto.com)



PHOTONICS FESTIVAL in TAIWAN



# LED Lighting Taiwan

The 9th Int'l LED Lighting Exposition  
[www.optotaiwan.com](http://www.optotaiwan.com)

### Exhibits

- LED Lighting Fixture
- LED Applications
- Package / Module
- Epi Wafer / Chip
- Materials
- Processing Equipment
- LED Plant Factory
- OLED Lighting



**June 18 -20**  
TWTC Nangang Exhibition Hall

# VIP BUYERS Inviting!

Free Accommodation / Flight Ticket

### Organizer



Photonics Industry & Technology Development Association  
5F, No.9, Sec.2, Roosevelt Road, Taipei 10093, Taiwan  
Tel : +886-2-2351-4026 Fax : +886-2-2396-8513

[ Overseas contact ]

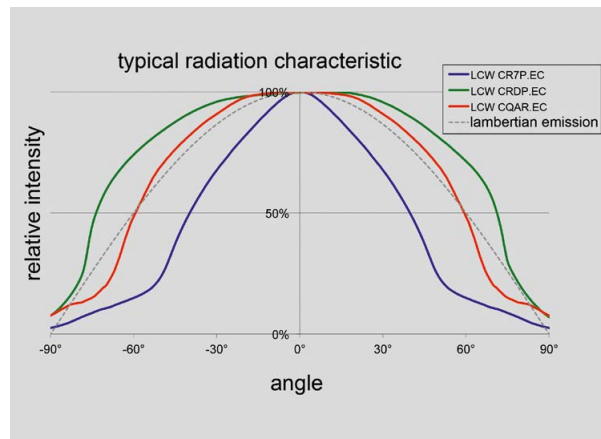
Vanessa Hou (ext. 883) E-mail : [vanessa@mail.pida.org.tw](mailto:vanessa@mail.pida.org.tw)



**Figure 8 (left):**  
LEDs with highly reflective packages help minimize losses



**Figure 9 (right):**  
Different emission profiles of Oslon SSL 80, Oslon SSL 150 and Oslon Square compared with lambertian emission



emission characteristics wisely. It is best to simulate the complete lighting system with the aid of optics design software. As a light source one should use ray files of the LEDs which contain near field information. Thus, the complete ray path of the light can be checked in the first place.

### Efficiency in the Luminaire System

Generally speaking, only the light emitted in the half-space in front of the LED can be used. Another possibility of improving the efficiency of a luminaire is to shape the light by the LED itself. This requires special lens geometries for the primary optics of the LED. A spherical lens, as it is commonly used for high power LEDs, hardly changes the intensity distribution of an LED at all. By using aspherical lenses, in other words, ones that deviate in some way from the pure spherical shape, almost any intensity distribution or half width angle of emission can be achieved (Figure 9). Good examples are the different Oslon SSL LEDs that are available with emission angles of 80° and 150°. The Oslon SSL 80 has a lens that is higher than a sphere of the same diameter. This lens has a higher power than a corresponding spherical lens of the

same diameter, so the angle of emission is smaller. The Oslon SSL 150, on the other hand, has a flatter lens than a corresponding sphere so the angle of emission is wider. Narrow or wide angles of emission have different benefits depending on the application. A narrow angle – such as that of the Oslon SSL 80 – is ideal for the use of lenses as secondary optics because more light hits the lens and the light can be better shaped. A wide angle – such as that of the Oslon SSL150 – is suitable for reflectors. The cumulative luminous flux increases slowly, the luminous flux at wide angles is very high. The light can therefore be shaped very efficiently, even if flat reflectors are used. If the overall system has a low profile, surfaces can be uniformly illuminated by keeping a narrow system height. This effect is used in panel lights and simple downlights.

The emission profile of the Oslon Square LED deviates from the lambertian emission characteristic but the half width corresponds to that of many LEDs and is 120°. Within the half width the luminous intensity is greater than that of a lambertian emitter, and smaller outside the half width. This means that the best possible use can be made of the available luminous flux in the particular application.

The LED chips in all the Osram high-power LEDs are mounted in a highly reflective package. All light is turned into useful, be it the margin of light scattered to the back or the light coupled into the LED from cluster applications. It is therefore not lost for the application.

### Summary

Data tables for LEDs are useful in providing an overview of their properties but they are not sufficient for designing a complete lighting system that has to operate at maximum efficiency in terms of power consumption and operating costs. The emission behavior of the LEDs also needs to be known in detail and checked against the requirements of the application. The recommended way to prove the performance of the LEDs inside the luminaire is to simulate the complete system with an optics design software and ray files of the used light sources. OSRAM offers measured ray data for all LEDs and all standard programs. By considering all this, disappointments when building up first samples of a luminaire will be a thing of the past. ■

#### Definitions:

**Emission characteristics:** Radiant power per solid angle as a function of the direction of emission; the solid angle is defined as the surface projected onto a sphere, divided by the square of the radius of this sphere.

**Half width:** Angle of emission at which the luminous intensity has fallen to 50 percent of the maximum luminous intensity.

**Cumulative luminous flux:** Cumulative light output of a light source that is emitted in a cone with an opening angle  $\alpha$ .



**LIGHTFAIR**

INTERNATIONAL

**2013**

**THE FUTURE. ILLUMINATED.**  
We see the future clearly. And so will you.

Philadelphia, PA USA  
Pennsylvania Convention Center  
4.21.13 – 4.25.13

[www.lightfair.com](http://www.lightfair.com)



In collaboration with  
The Illuminating  
Engineering Society

**IALD**

In collaboration with  
The International  
Association of  
Lighting Designers



**AMC**

Produced &  
Managed by  
AMC, Inc.

**PHOTO CREDITS**

(1) BANNER MD ANDERSON CANCER CENTER LANTERN OF HOPE, GILBERT, AZ USA | LIGHTING DESIGN BY CANNON DESIGN | © BILL TIMMERMAN / © MARK SKALNY (2) UNITED STATES INSTITUTE OF PEACE, WASHINGTON, DC USA | LIGHTING DESIGN BY LAM PARTNERS | © GLENN HEINMILLER, IALD, LAM PARTNERS, © BILL FITZ-PATRICK, UNITED STATES INSTITUTE OF PEACE (3) CHANDLER CITY HALL EXTERIOR LIGHTING, CHANDLER, AZ USA | LIGHTING DESIGN BY SMITHGROUP JJR | © TIMMERMAN PHOTOGRAPHY

# An Economical Omnidirectional A19 LED Light Bulb

Since 2009, when the Japanese government was vigorously promoting LED bulbs in end-market applications, they have become mainstream commodities in the LED lighting market. Chen-Peng Hsu, project manager of Electronics and Optoelectronics Research Laboratories at Industrial Technology Research Institute (ITRI), introduces the R&D 100 award-winning invention of an omnidirectional A19 LED light bulb that is light weight and economical.

In 2009 the EU voted to ban all incandescent bulbs starting in September 2012. The US followed suit and will ban them starting January 2014. Before they were completely outlawed, there were still enthusiasts for incandescent bulbs for a variety of reasons. The majority of consumers want to be a part of the global effort to reduce carbon, in any way they can. Most people don't mind paying slightly more for green products than the original non-green that needs to be replaced – in this case, a home light bulb. However, if the extra cost to conserve energy becomes difficult or unaffordable for people, using green products could become difficult, making the promised green technology carbon reduction unlikely to happen. This means that until it is mandated by law, most households will most likely stick to the old technology of incandescent and compact fluorescent lamps.

ITRI's project team was assigned a task to develop a commercially viable LED light bulb. Team members soon realized one simple fact: Technologically, LED light bulbs are ready for the mainstream, but the price just isn't what people are willing to pay. LED light bulbs have been around for a while to replace traditional incandescent and CFL. The only reason people don't purchase them is because of consumer price. For the majority of consumers, their main concern when using LED light bulbs is not how much electricity it can conserve, it is the cost. A few LED bulbs that are more energy-conserving won't make a noticeable difference on the household electricity bill. Even if it did, the savings don't justify the additional cost for the bulbs.

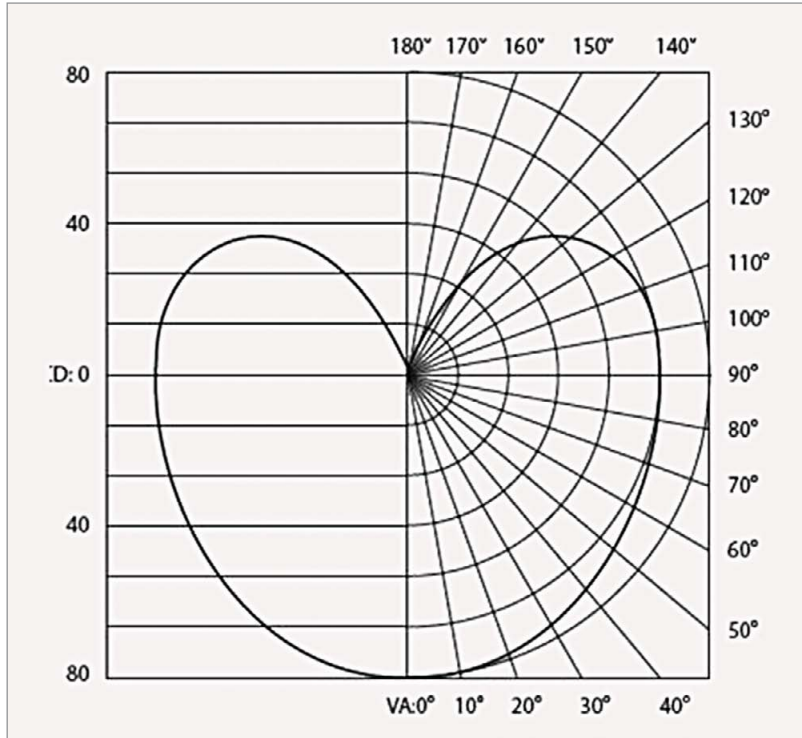
The purchasing power of the few consumers willing to pay more than the "mainstream price" does not constitute the drive for a sustainable and self-propelling market that would contribute significantly to carbon reduction.

Thus, the target was to develop a technology that manufactures quality LED bulbs cheap enough, not only to compete for the market share, but also to encourage voluntary LED bulb use before it is required by law. This is what ITRI's LED bulb technology is required to do.

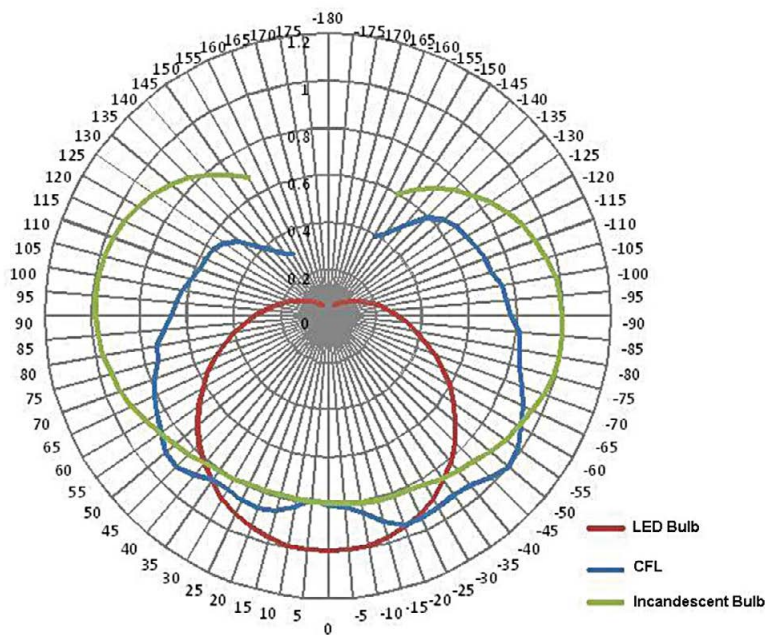
Traditional 60-watt bulbs have an output of 800 lumens and above, with an illumination angle of 270° (Figure 1). However, incandescent bulbs generally have poor luminous efficacy, and are not a source of cold light. The more light they emit, the more heat they produce, and both heat and light are transmitted to the illuminated area. This is why LED manufacturers have been doing everything they can to develop LED bulbs that can eventually replace incandescent bulbs.

LED manufacturers have invested a lot of resources in research and development and produced a series of LED bulbs with diversified choices to consumers. In general, most commercial LED bulbs are non-omnidirectional and have illumination angles of approximately 140° (Figure 2). In addition, less powerful bulbs with a lower luminous flux output claim to be able to replace 60-watt incandescent bulbs because they produce the same illuminance or lux on a workspace. In fact, these LED bulbs cannot produce the same or similar lighting effects as an incandescent bulb. This is also true for some of the improved LED replacement bulbs that are able to deliver over 800 lumens. This poses problems for many lighting applications.

**Figure 1:**  
Luminous intensity distribution of traditional incandescent bulb



**Figure 2:**  
Comparison of intensity distributions of different light bulbs: LED bulb (Red Curve), CFL (Blue Curve), and incandescent light bulb (Green Curve)



**Figure 3:**  
Conventional LED bulb (a), Omni-directional light with remote phosphor structure inside the LED bulb from Cree (b) and Philips (c)



Therefore, in the last couple of years, first-tier LED lighting companies have presented several second-generation LED light bulbs that stressed wider illumination angles to fit the real light distribution curve of incandescent bulbs. But for now, thermal management, uniform light distribution, luminous efficacy and costs are still major problems. In practice, LED light bulbs have not yet been able to capitalize on technological advantages as expected so far.

The first reason is because of the limited body or heat sink design of the A-type light bulb and insufficient heat dissipation area. The generated heat cannot be effectively and quickly dissipated to the outside air. Therefore, not only the performance of total lumen output, but reliability and durability are influenced. In addition, it is hard to attain a wide illumination angle, high luminous efficacy and cost effectiveness simultaneously.

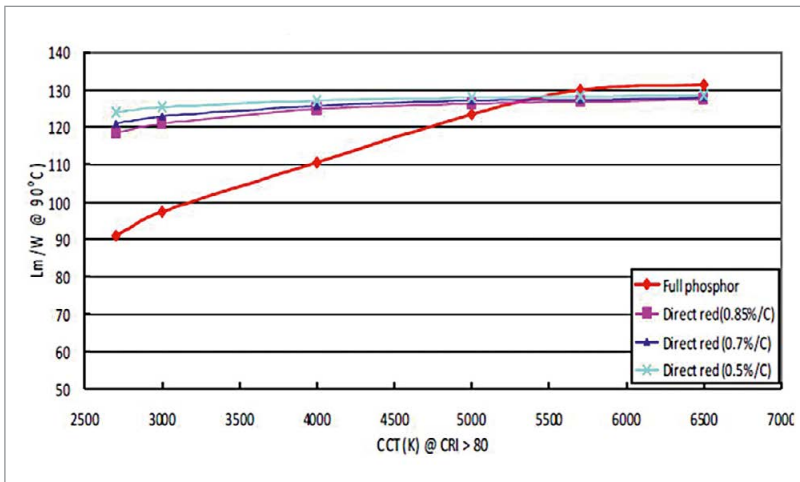
### Omni-directional LED Bulbs

Figure 3a shows a conventional LED bulb where the LED module is mounted face-up and emits light upward. This is mostly due to the radiation angles of LEDs which are essentially about 120 degrees. In addition, bulb structures such as the PCB board and heat sink block downward light. Hence, the conventional design of the LED bulb makes it difficult to obtain omni-directional light. In order to achieve omni-directional light, LED bulb manufacturers have delivered representative products with various improved structures.

**Figure 4:**  
Philips L-Prize  
award winning  
LED light bulb



**Figure 5:**  
Efficacy of  
white-LEDs with  
full phosphor  
(red curve) and  
red LEDs (other  
curves), data  
provided by  
Epistar



To further increase efficacy, the efficacy bottleneck of a warm-white LED can be overcome by using a red LED instead of lower efficiency red phosphors commonly used in many warm white LEDs, as shown in figure 5. Philips presented another improved bulb design. By utilizing three sets of equally spaced LED modules vertically-mounted on the heat sink, three sets of rigid phosphor shells then cover the LED modules. Firstly, the LED module mixed high power red LEDs to improve warm white efficacy. Secondly, LED modules are combined with the remote phosphor shells building the bulb body. This can effectively emit side or large angle light to obtain omni-directional light. The bulb also won the L-Prize Award in 2011 for highest performance in the replacement of 60-watt incandescent bulbs.

**Figure 6:**  
Omni-directional  
LED bulbs using  
secondary lens,  
left is from Sharp  
and right is from  
Toshiba



Figures 3b and 3c show the omni-directional light bulbs with remote phosphor structures inside the lamps. These bulbs use phosphor cap structures placed above the blue LED light sources to convert emitted blue

light into yellow or mixed long wavelength colors and form scattered uniform white light. Then the white light is further scattered by the diffusing bulb globe placed over the phosphor cap to achieve wide illumination patterns.

In addition to remote phosphor, secondary optics is the most common method used to increase the illumination angle of the LED bulb. Figure 6 shows different LED bulbs use reflectors (left) and a secondary lens (right) to reach wide illumination angles. The concepts are similar to side-emitting lenses that used to be applied in LED backlights. The reflectors or lenses are placed on the LED module inside the light bulb. This changes most directions of the light towards large angles and then the bulb globe diffuses the light to generate a uniform light pattern.



# Bodo's Power Systems®

Your best choice to communicate!

Free subscription on  
[www.bodospower.com](http://www.bodospower.com)  
[www.bodospowerchina.com](http://www.bodospowerchina.com)

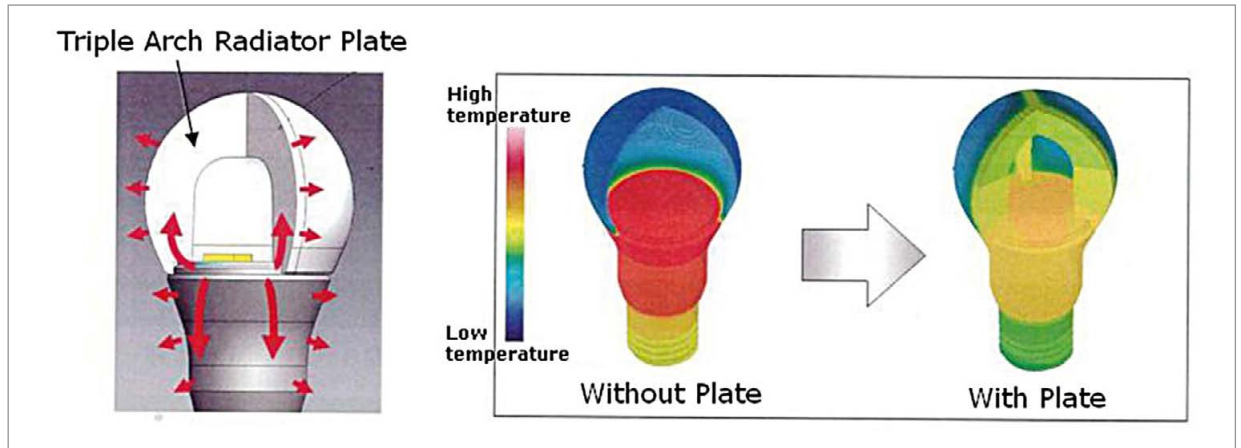
One World  
One Magazine  
On Time, Always



Partner with these events:



**Figure 7:**  
Heat dissipation design concept of Toshiba's new wide angle light bulb



To further increase efficacy, Toshiba improved both optical and thermal designs. By forming three radiator plates (called "Triple Arch Radiator Plate") like ribs vertically connected inside the light diffusive globe of the LED light bulb, heat can be efficiently conducted from the LED module on the bottom to the radiators and released to the outside. In addition, the temperature distribution becomes more uniform. This will significantly enhance the efficacy of the LED light source. In addition, radiator plates also play the role of a light reflector and change light directions into large angles. Figure 7 shows the design concept of the new wide light distribution angle LED light bulb proposed by Toshiba.

### Light&Light™ LED Bulb Technology

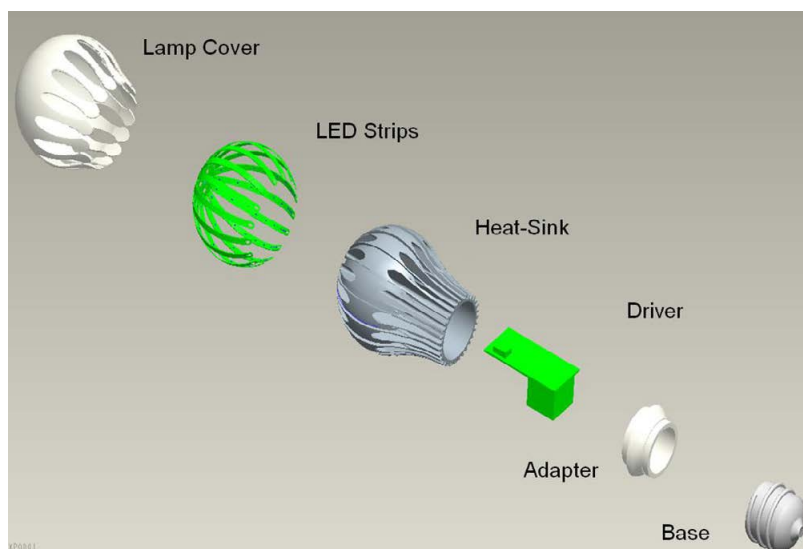
To make a quality A19 LED light bulb that is low in manufacturing costs yet delivers good performance requires a systematic approach that includes

every aspect of LED lighting engineering. The ITRI team decided on one single basic principle for the design of the bulb as an effective thermal dissipation system: Increase the overall surface area of all LEDs combined in the bulb system.

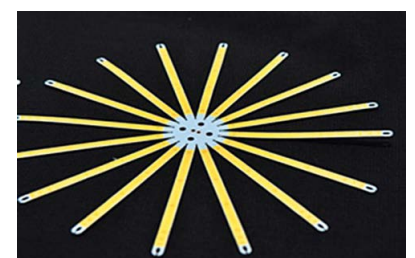
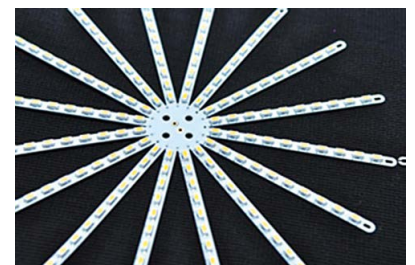
This leads to the idea that the heat sink, as a physical structural part of the bulb, can also double as the main bulb body. The whole size of the standard A19 bulb maximizes heat dissipation capacity. Besides this, instead of the conventional approach of using a dozen high power LEDs, the first prototype/demonstrator bulb uses a large number of ca. 150 low-power LEDs to generate the targeted total lighting capacity. Further, the LEDs need to be distributed as evenly as possible over the entire surface of the A19 heat sink to create an omni-directional lighting pattern of the bulb. Of course, the light distribution pattern can be designed as desired by different heat sink shapes and the arrangement of the LEDs.

ITRI Light&Light bulb has a simple construction. Figure 8 is an explosion view showing all the components that make up the bulb. The bulb body is a hollow structure much like a conventional bulb except that it has openings to allow air flow for the coiling of the electronic power circuit that actually lights up all the LED chips. All the low-power LEDs are automatically mounted to a flexible printed circuit board forming the LED strips that, before installation onto the bulb body, resembles the shape of a starfish. Figure 9 shows two versions of this 16-hand starfish with each hand carrying ten LEDs. For 10 W total power consumption each LED consumes less than 60 mW during operation. The surface mount device version of the LED flexible PCB was used to construct the demonstrator bulbs, and a COB (chip on board) version that is also suitable for mass production.

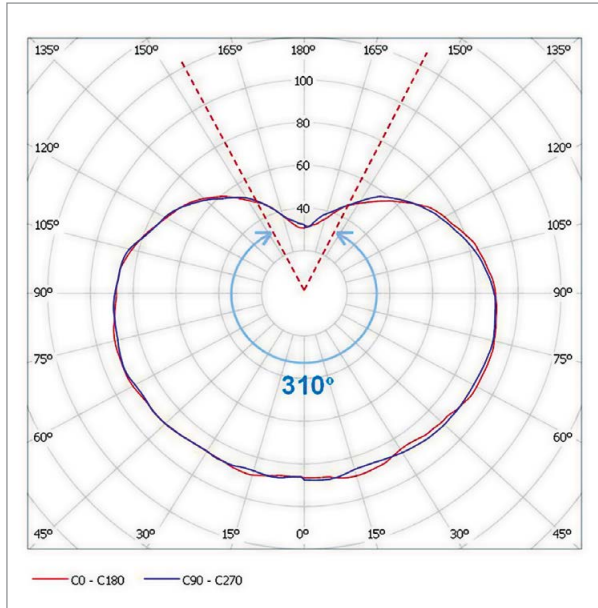
**Figure 8 (left):**  
A Light&Light™ bulb broken down in its parts



**Figure 9 (right):**  
SMD (top) and COB (bottom) version of 16-hand starfish-shaped flexible PCB LED module



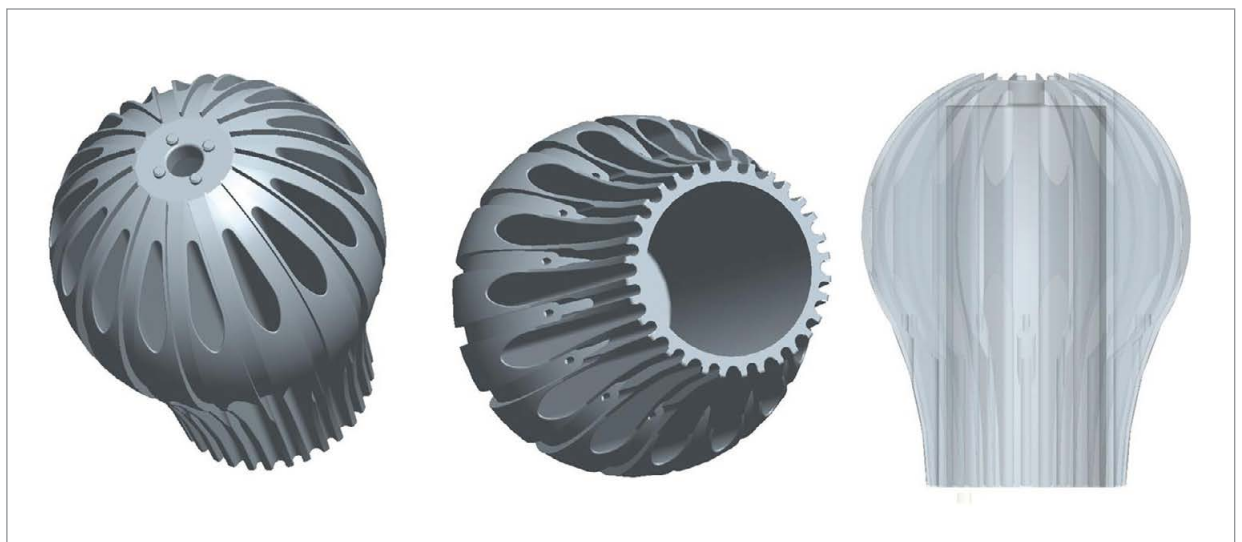
**Figure 10:**  
Omni-directional  
light distribution  
of ITRI's bulb



Along the bulb head contour, the large number of LEDs are distributed evenly in a pattern that encloses almost the entire surface. This is to improve even distribution of both the lighting and the heat dissipation. For assembly, the starfish-shaped PCB, literally “grabs” the bulb head with all its hands. The permanent grab is achieved by thermally conductive adhesive, so that heat generated by the LEDs can be transferred to the bulb body for dissipation. A transparent cover then wraps the bulb head to protect the LEDs and also serve as a light diffuser when required.

In order to reach the luminous intensity distribution of a 60-watt incandescent bulb, the sixteen flexible LED strips can provide 360° coverage at 16° intervals. By adjusting the spacing between the ten LEDs on each strip, the desired luminous intensity distributions are attained, as shown in figure 10. Due to the curved surface design of the A19 heat sink combining with the LED arrangement, no secondary optics, such as reflector or wide-angle lenses, are needed to achieve wide illumination angles.

**Figure 11:**  
Heat sink of the  
new A19 LED bulb  
concept



## Heat Dissipation Design

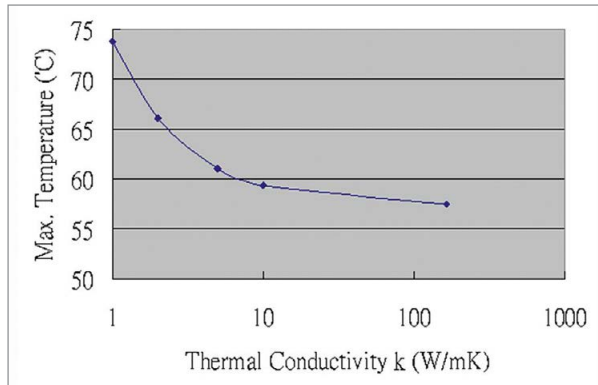
Conventional LED light bulbs use metallic heat-conducting material placed underneath the light source. Metal materials have high thermal conductivity and conduct heat quickly. However, they do not possess enough surface area for heat convection to the air. This limits the performance of LED bulbs and forces some LED bulb makers to use relatively high-grade LED light sources to get higher efficacy and sufficient luminous flux, which significantly drives up the manufacturing costs of producing an LED bulb.

Calculations done by the team suggested that a plastic A19 heat sink will be sufficient – provided that the plastic material must still have a thermal conductivity no less than about 1 W/mK. By contrast, typical ABS plastics (acrylonitrile butadiene styrene) have a conductivity of 0.2–0.3 W/mK, and aluminum alloy roughly 170 W/mK. Then, since the plastic heat sink is inferior in terms of heat dissipation than an aluminum counterpart, the requirement is as large a heat sink surface area as possible.

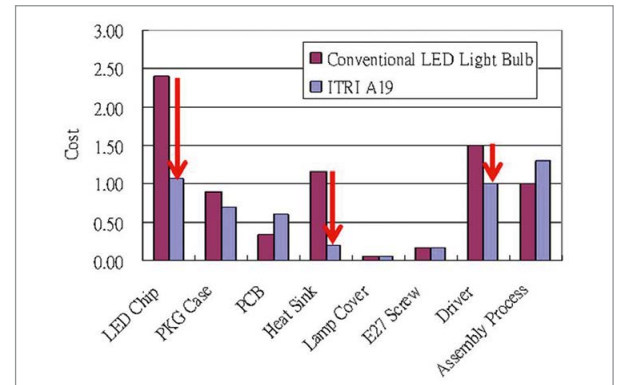
Figure 11 shows the structural construction of the bulb body of a Light&Light™ bulb. Except for the LED strips and LEDs, every part of the bulb are effectively designed and turned into heat dissipation features. The interstices between the strips contain longitudinal channels. These channels not only increase surface area but are optimized pathways for heat convection. Based on consideration of how the bulb will be used: normally, bulbs are not oriented upwards, but rather downwards. Figure 12 is a comparative simulation for maximum junction temperature of an LED for the A19 heat sink body with different coefficients of thermal conductivity. The results show the maximum temperature is below 70°C for the total 10 W LEDs distributed uniformly on the surface of the A19 heat sink with thermal conductivity of 3 W/mK.

This leads to the call for the design of such a heat sink plastic and another team at the Material and Chemical Research Labs in ITRI developed the high thermal

**Figure 12 (left):** Simulation of thermal conductivity versus maximum temperature for the A19 heat sink



**Figure 13 (right):** Cost structure and reduction of Light&Light™ bulb compared to conventional LED bulbs. The figures relating to cost are for reference only. They are not absolute values



conductivity plastics technology. The material technology that produces the plastic structure used as both the bulb body and the heat sink is key to this bulb in several different aspects. First, it provides a backbone of the bulb that serves as the basic bulb body and further doubles thermal capacity. In addition, the body/heat sink double-role plastic structure has a benefit for the bulb system to be mechanically strong and much lighter than a conventional bulb with a metallic heat sink. The weight of the first prototype/demonstrator bulb is below 100 g compared to conventional equivalent LED bulbs that are usually about 180 g in weight.

And most importantly, it is inexpensive. It can even be recycled to construct another bulb body. Basically it is a thermoplastic composite material with high thermal conductivity. Moreover, by adopting plastic instead of aluminum, the carbon reduction attributable to this material replacement is almost 70% – one more step toward green lighting.

### Cost Effective

All the above good characteristics of this Light&Light™ technology add up to an LED bulb that is relatively lower in cost to manufacture and delivers almost all of the desirable characteristics an ideal LED bulb can possibly offer. Figure 13 breaks down the cost of a bulb into all detailed items to show how the new technology is able to reduce cost compared to the conventional LED bulb technologies. Figure 14 shows lit-up Light&Light™ bulbs and a comparison with other bulbs that demonstrates its superiority in terms of its light weight, high efficacy of 85 lm/W. This shows that it is really an omnidirectional replacement lamp. The most significant cost reduction is contributed by the use of numerous small LEDs instead of the conventional practice of using a few high power ones. This almost halves the LED costs. The other reasons for cost reduction come from the use of plastic to replace the aluminum alloy heat sink driver due to the electrical isolation of the plastic bulb body and there is no need of secondary optics or remote phosphor structure.

### Conclusion

What good is an LED that is too expensive for consumers to buy? ITRI Light&Light™ A19 LED bulb technology is outstanding for one single, most important reason: It has a down-to-the-ground cost to support a market price acceptable to the mainstream without sacrificing performance, light weight, high efficacy, sufficient luminous flux, omnidirectional illumination and colorful body. ITRI Light&Light™ bulb technology beats its competitors in terms of performance and costs. In relation to performance, the technology is superior in its flexibility in lighting distribution characteristics while maintaining high efficacy. It can be tailored to be omnidirectional or more concentrating depending on the application. There is no need for the use of secondary optics, which means it typically reduces lighting efficiency. The advantages of high design flexibility, low manufacturing costs, and a full patent portfolio enable the development of other LED lighting products, not just light bulbs. ■

**Figure 14:** A lit-up Light&Light bulb (left) and a comparison between table lamps (right) with a Light&Light™ bulb, a traditional incandescent lamp as a reference and a competitor's bulb (from left to right)



# A World of new & Innovative LED Lighting Products & Technology

Join in LEDexpo Thailand's "Face to Face Sourcing Meetings"!

We will launch "Face to Face Sourcing Meetings" on site. It aims at establishing an efficient business platform for the exhibitors and buyers. This will help to enhance the communications between the suppliers and buyers. Register to join the "Face to Face Sourcing meeting programme"?

Please send an email to [himani@themediexpo.com](mailto:himani@themediexpo.com) for the same.

# THAILAND LED EXPO 2013



## THAILAND INTERNATIONAL EXHIBITION ON LED LIGHTING PRODUCTS & TECHNOLOGY

**23|24|25 MAY 2013**  
Hall 4, IMPACT Exhibition  
& Convention Center  
Bangkok, THAILAND

**BROAD EXHIBIT SEGMENTS:**

- LEDS
- LED APPLICATIONS & LIGHTING
- LED LIGHTING PRODUCTS
- LED PRODUCTS
- LED SIGNAGE & DISPLAYS
- LED COMPONENTS / ACCESSORIES & RAW MATERIALS
- LED DRIVERS & POWER SUPPLY
- LED MANUFACTURING EQUIPMENT/ MACHINERY & ALLIED PRODUCTS

Over 150 Quality Exhibitors

Booming domestic consumers market of 67 million people

Ideally located at the cross roads of Asia, offers potential business opportunities with emerging markets of China, India & Asian countries

Thailand's current LED market is \$ 27 million or 12% of total lighting market share & is expected to increase up to 45-50% by 2015.



Scan with your smart phone

Log on to [www.ledexpothailand.com](http://www.ledexpothailand.com) to PRE-REGISTER TODAY

Host Organization :



Platinum Sponsors :



Supporting Publications :



Supported by :



Organizers:



MEX Exhibitions Pvt. Ltd

9, LGF, Sant Nagar, East of Kailash, New Delhi-110065, India  
Mobile(India): +91-9810301644, +91-9312285142

Email: [phasantib@impact.co.th](mailto:phasantib@impact.co.th), [panvisutb@impact.co.th](mailto:panvisutb@impact.co.th) E-mail: [himani@themediexpo.com](mailto:himani@themediexpo.com), [gaurav@themediexpo.com](mailto:gaurav@themediexpo.com)

Official Media Partner :



# Imprint

LED professional Review (LpR), ISSN 1993-890X

## Publisher

Luger Research e.U.			
Institute for Innovation & Technology	phone		+43 5572 394 489
LED professional Dept.	fax		+43 5572 394 489-90
Moosmahdstrasse 30	email	editors@led-professional.com	
A 6850 Dornbirn, Austria / Europe	web	www.led-professional.com	

## Publisher

Siegfried Luger	phone	+43 5572 394 489-70
	email	s.luger@led-professional.com

## Editor-in-Chief

Arno Grabher-Meyer	phone	+43 5572 394 489-18
	email	a.g-m@led-professional.com

## Int. Account Manager

Theresa Koenig	phone	+43 5572 394 489-20
	email	theresa.koenig@led-professional.com

## Marketing & Sales Manager

Katharina Fink	phone	+43 5572 394 489-43
	email	katharina.fink@led-professional.com

## Cover-page

Image: Arno Grabher-Meyer, LED professional; LUXeXcel optics & FSIGN luminaire  
Artwork: Thomas Klobassa, ©LED professional 2013

## Copyrights – Luger Research e.U.

The editors make every reasonable effort to verify the information published, but Luger Research e.U. assumes no responsibility for the validity of any manufacturers, non profit organisations or individuals claims or statements. Luger Research e.U. does not assume and hereby disclaims any liability to any person for any loss or damage caused by errors or omissions in the material contained herein, regardless of whether such errors result from negligence, accident or any other cause whatsoever. You may not copy, reproduce, republish, download, post, broadcast, transmit, make available to the public, or otherwise use LED professional Review (LpR) content without prior written consent from Luger Research e.U. – Institute for Innovation & Technology, Austria. ■



## LED professional Review (LpR) - Annual Subscriptions

### LpR Digital Magazine

- 6 issues
- pdf download
- high resolution pictures and graphs
- printable
- commercial use
- access to all previous issues
- Euro 78.80

### LpR Printed Magazine

- 6 issues
- Euro 158.40

<http://www.led-professional.com/subscription>

## Next LpR: Thermal Management & Reliability Issue 37 - May/June 2013 - Short Overview

### Thermal Management: Looking Beyond Thermal Conductivity Values

Going deeper into the options of available thermal management product types, the article explains how the efficiency of thermal transfer is not as easily determined as a simple thermal conductivity value may lead you to believe. It addresses the different methods for measuring thermal conductivity, the relevance of thermal conductivity values and finishes with considerations for correct product selection and use.

### Thermal Management: Choosing the Appropriate Heatsink

Alongside vibrations and moisture, temperature-related stress on electronic semiconductor elements are the most common causes of failure for electronic components and devices. Effective thermal management is unavoidable to ensure their durability, reliability and performance. Thermal basics as well as heatsink fabrication issues like materials, tolerances and thermal conductivity will be explained. The influence of surface coatings and installation position will be discussed and customization options demonstrated.

### LED Technology: Nano-Patterned Sapphire Substrates and Optical Lithography

Objective material selection for various target applications is key for successful product development. The article will explain how features of Efficient light extraction is crucial for highly efficient LEDs, where surface patterns and PSS add a great deal. PHABLE™ (short for Photonic Enabler) is a novel lithography method enabling the printing of features sizes in a non-contact, proximity process. Using a diffractive approach allows regular, sub-µm patterns as small as 200nm to be printed with a proximity mask aligner.

subject to change

# LpS 2013

**LED** | SYMPOSIUM  
professional | +EXPO

3<sup>rd</sup> annual  
LED professional  
Symposium & Exhibition

## LED Lighting Technologies

International Winning Approaches

**24-26 SEPT 2013 | BREGENZ | AUSTRIA**

**Europe's Foremost LED Lighting Technology Event**

LUGER RESEARCH | Moosmahnstrasse 30 | 6850 Dornbirn  
T +43 5572 39 44 89 | F +43 5572 39 44 89 90

[info@lps2013.com](mailto:info@lps2013.com) | [www.lps2013.com](http://www.lps2013.com)

# Light Your Brand with LG Innotek

Mid Power LEDs Optimized for Indirect Troffer Applications



## LG Innotek's 5152 Mid Power Series

The 5152 mid power series offers high efficacy and reliability with ANSI compliant binning. This series is a LM80 certified product that features a minimum CRI of 80, and is available in cool, neutral and warm-white.

Visit [www.FutureLightingSolutions.com](http://www.FutureLightingSolutions.com) for product information and availability