

TTB: Jamie Singerman

Research: AlGaN/GaN-on-Si FET Drivers

Technologies: High Frequency LED Drivers

Applications: Interior Automotive Lighting

**FUTURE**  
Lighting Solutions  
www.FutureLightingSolutions.com

**MOSO**<sup>®</sup>

# Outdoor DALI LED Driver

Official DALI Member



## LUC-25W/42W Linear

- ▶ IP67
- ▶ Compact Size
- ▶ 5% average ripple, THD<10%
- ▶ DALI Control



CB CE



## LCP-75~240W Linear

- ▶ IP67
- ▶ Output Programmable
- ▶ Constant Power
- ▶ DALI, 0-10V/PWM/Timer Dimming Optional



CB CE



## 160~240W High Bay

- ▶ Round Shape UFO
- ▶ Constant Power
- ▶ Output adjustable
- ▶ DALI, 0-10V, PWM Dimming Optional



CB CE



UL US  
E332688

SAA



### Application:

- ▶ Exterior Lighting Fixtures Semi-outdoor Circumstances Metro, Plant, Stadium, etc.

Be the **FIRST** to download or  
sign up for your **FREE** copy **NOW**.

**NEW** All in 1   
LED Lighting Solutions Guide



 **FUTURE**  
Lighting Solutions

[www.FutureLightingSolutions.com](http://www.FutureLightingSolutions.com)



# LaaS

Two years ago, following the circular economy strategy, Philips launched one of the first systems where the option for “Light as a Service (LaaS)” was installed at Schiphol Airport in The Netherlands. Circular economy is characterized by customer access over ownership, business model innovations, innovations for material, component and product re-use, products designed for disassembly and serviceability. Philips retained ownership of all the equipment, while the Schiphol Group leased it for the duration of the contract.

Philips’ global head of sustainability, Henk de Bruin, describes the need to ‘decouple our material use and energy consumption from economic growth, and to experiment with leasing contracts instead of relying on a “boxed product” business model.’ When Philips worked on the fit-out of the practice’s offices in Amsterdam, architect Thomas Rau said: ‘I’m not interested in the product, just the performance. I want to buy light, and nothing else.’ The result was a lighting system that made extensive use of free, natural light and specially adapted LED fittings with a combined daylight sensing and control system to cut energy use, provided as a service. But there are also other examples already on the market. One example is Zumtobel’s LaaS scheme called NOW!

**In a comparison of the pros and cons for a LaaS, we find there are good arguments for both sides:**

Pros:

- No upfront investment
- Allows nominal upgrades to be completed within the existing operational expenditure of the contract
- Subscribers are immediately cash flow positive
- Constant energy savings
- Burn outs are not your responsibility
- Quality service providers make sure that upgrades comply with the latest local and federal requirements

Cons:

- You’ll be held to the terms of the agreement for the duration of the contract
- Net monthly costs reduced, but not as much as if you make the up-front investment in the project since you’ll have to factor in monthly lighting as a service payment
- Like any payment program, the interest and fees associated with breaking the total cost into monthly fees will result in an overall cost that is higher than the cost of paying for everything up-front

LaaS business is expected to grow by roughly 10% per year over the next five years. Recently the Rocky Mountain Institute in the US released a report called “Lumens as a Service” focusing on how to capture the technology-enabled business opportunity for advanced lighting in commercial buildings. They have pointed out that, together, advanced lighting technology, digital controls and third-party control systems can accelerate the growth of the LED market in general. This will especially improve or enable daylight harvesting, occupancy tracking, demand-response and peak load shaving/shifting, distributed supervisory control over lighting and individual local control over lighting.

Circular economy in lighting and LaaS business models will dramatically influence product designs, especially the digitalization of systems. In this issue you can read about how to prepare your design to get ready.

Have a good read.  
Yours Sincerely,

Siegfried Luger  
Publisher, LED professional

# LpS 2017

**LED SYMPOSIUM**  
professional +EXPO

**OPEN PROGRAM**

[www.lps2017.com/event\\_program](http://www.lps2017.com/event_program)

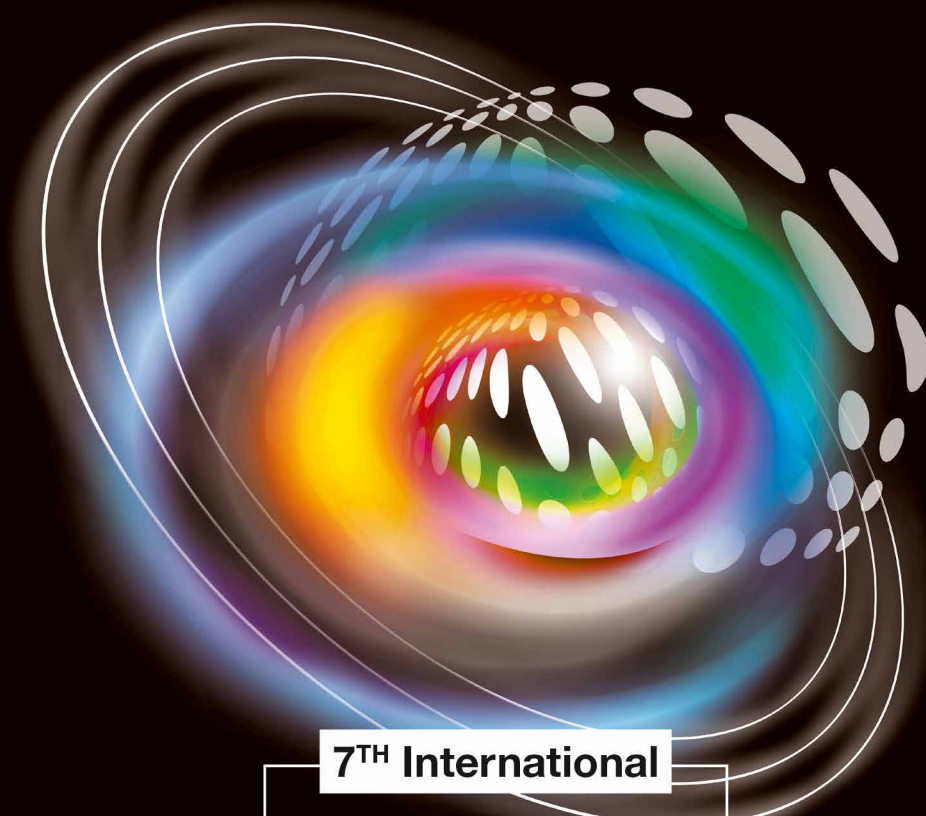

**7<sup>TH</sup> International**

## LED professional Symposium +Expo

The Lighting Event for Technologies of Tomorrow



LpS is the leading international lighting technologies event for design, testing and production of lighting systems, controls and equipment.

SEPTEMBER 2017

**26<sup>TH</sup> - 28<sup>TH</sup>**

BREGENZ

**AUSTRIA**

[www.lps2017.com](http://www.lps2017.com)

Organized by Luger Research e.U.



COMMENTARY

08 Lighting Delivering Increased Value to Society - A Strategy for Growth  
by Peter Hunt, Lighting Industry Association

TECH-TALKS BREGENZ

26 Jamie Singerman, Worldwide Corporate Vice President at FLS  
compiled by Siegfried Luger, LED professional

RESEARCH

32 LED-Retrofit Based on AlGaIn/GaN-on-Si Field-Effect Transistor Drivers  
by Andreas Zibold et al., Fraunhofer Institute for Applied Solid State Physics IAF

TECHNOLOGIES

36 LED Driver Miniaturization - Opening New Opportunities for Solid State Lighting  
by Mickey Madsen, Nordic Power Converters

42 SoC Technologies in Lighting - Today's Landscape and Tomorrow's Practices  
by P. Winiarczyk & S. Rządkosz, Silvair

QUALITY

46 Avoiding Brightness and Color Mismatch with Proper RGB Gamut Calibration  
by Rood Bouten, Admesy

APPLICATIONS

52 Interior Automotive Lighting Control Redefined  
by Roland Neumann, Inova Semiconductors

REGULARS

04 EDITORIAL  
08 COMMENTARY  
10 PRODUCT NEWS  
19 RESEARCH NEWS  
22 REGULATION NEWS  
23 EVENT NEWS  
24 CIE RESEARCH

58 ABOUT | IMPRINT

HIGHLIGHTS

36 LED Driver Miniaturization - Opening New Opportunities for Solid State Lighting  
by Mickey Madsen, Nordic Power Converters

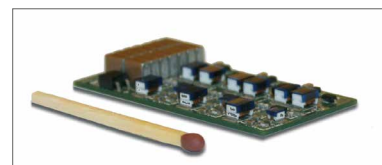

52 Interior Automotive Lighting Control Redefined  
by Roland Neumann, Inova Semiconductors

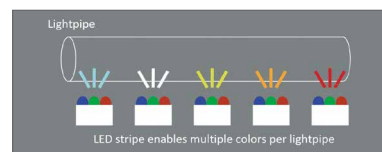

ADVERTISING INDEX

FUTURE LIGHTING SOLUTIONS	1	EDISON	13	EPISTAR	21
MOSO	2	INSTRUMENT SYSTEMS	14	CREE	35
FUTURE LIGHTING SOLUTIONS	3	GRE ALPHA ELECTRONICS	16	TOPSIL	41
LED PROFESSIONAL SYMPOSIUM	5	WAGO	17	AUER LIGHTING	49
ZHONGSHAN GUZHEN LIGHTING	7	FULHAM	18	INOVA SEMICONDUCTORS	51
TRENDS IN LIGHTING	8	DOW CORNING	19	LUMITRONIX	57
INSTRUMENT SYSTEMS	11	KDG	19	LED PROFESSIONAL REVIEW	59
LEDFRIEND	12	RECOM	20	ACEVEL	60



Original Source of Lightings  
for 6 billion people worldwide

# Lighting Fair The 20<sup>th</sup>

The 20th China (Guzhen) International Lighting Fair  
22-26 October 2017 Zhongshan, China

Register now,

To save 100 RMB Admission Fee and get VIP upgrading!

 <http://www.gzlightingfair.com/en>  [shay.gao@ubmsinoexpo.com](mailto:shay.gao@ubmsinoexpo.com)



Decorative Lighting | Household Lighting | Commercial Lighting | Outdoor Lighting

LED Lighting & Technology | Electrical & Electronic Product

Machinery & Equipment | Raw Material | Lighting Accessories & Components | 3D Printing | Hardware



### Peter Hunt

Peter Hunt has been involved in the lighting industry from an early age and received an Honours Degree in Ergonomics at Loughborough University. He also ran a successful lighting company in the UK. Mr. Hunt joined the Lighting Association Council of Management in 1987 and became President in 1992 during which time the Association established its own dedicated test laboratory for the industry. In 2008 he took over the role of CEO of the Lighting Association and played a key role in merging the LA with the Lighting Industry Federation in 2012 to create one association for the UK industry in the form of the current Lighting Industry Association, which represents 250 lighting companies and 150 associate members. He is currently COO of the LIA and CEO of the WEEE Compliance Scheme Provider, Lumicom.

## LIGHTING DELIVERING INCREASED VALUE TO SOCIETY - A STRATEGY FOR GROWTH

In recent years we have seen energy efficiency as the key driver for regulation as well as growth. Thanks to the arrival of LEDs the industry is already providing energy savings greater than any other sector. As the LED revolution rapidly continues, where next for the EU lighting industry? LightingEurope, the European industry association for the lighting industry has developed a strategy for growth which aims to fundamentally deliver value to society while aligning with the need to move towards a circular economy.

There is clearly more work to be done to complete the transition from older technologies to LEDs but this is well underway and the benefits of this first wave or “Ledification”, as it has been termed, are well understood. The next wave of technology is arriving already in the form of intelligent lighting systems which will create further efficiencies with additional benefits. This digital technology will require standard interfaces to adjacent industries in infrastructure, building management and IT. In order to deliver intelligent lighting systems we will need legislators to adopt a more simple approach that allows differentiation and is easy to enforce. An intelligent lighting system must deliver a quality lit environment; taking full account of the needs of the users.

This leads us on to the third wave of growth strategy for the lighting industry in the form of Human Centric Lighting. The increasing understanding of the “third receptor”

in the human eye, discovered relatively recently, is leading to the development of lighting systems that support the human response to light and how it drives our circadian rhythm. The right light at the right time can promote health, alertness, cognitive ability, quality sleep and general well-being. The adoption of Human Centric Lighting in hospitals can increase recovery times and free up beds. In schools, studies have shown an improvement in pupils’ concentration and test results and in the work environment it has been demonstrated that staff feel more comfortable and motivated while productivity improves. More research is clearly needed but since we spend around 87% of our time inside buildings, much of it under artificial light it seems logical that we should pay attention to the well-being of people through the delivery of the right lighting.

Each of these three waves of technological improvement add value to society and the quality of life through energy efficiency, sustainability and health benefits while giving increased consideration to one of the key aims of the EU Commission- the Circular Economy. The lighting industry seeks to significantly reduce its environmental footprint through designing products which can be repaired, upgraded, re-used, re-manufactured and recycled at the end of their useful life. There is little doubt that this approach is better for the environment while increasing employment prospects in the EU. ■

P.H.





Experience the Future of Lighting

**TIL 2017 SEPT 26-28**  
Bregenz Festspielhaus

# **SMART LIGHTING**

---

# **FORUM & SHOW**

---

FOR ARCHITECTS, LIGHTING CONSULTANTS, ELECTRICAL CONSULTANTS,  
LIGHTING DESIGNERS, LIGHTING OEMS AND IT/IOT SYSTEM INTEGRATORS

Human Centric Lighting | Connected Lighting  
Smart Controls | Internet of Things | Light as a Service

TiL is an immersive, international event designed for those at the forefront of lighting.

TiL addresses the big questions being asked in modern light design and technologies.

## First Multi-Chip LED with a Lens Improves Camera Flashes

There is a new addition to the Oslux family from Osram Opto Semiconductors. For the first time, two LED chips and a lens have been integrated into a module. The compact Oslux S2.1 multi-chip LED brings together all the high-tech company's extensive technical know-how into a new LED version for camera flash applications. With its brightness of 125 lux, it provides uniform illumination of photos and video recordings from mobile devices such as smartphones.



**The new Oslux S2.1 from Osram Opto Semiconductors provides easier handling and improves brightness and color uniformity thanks to "Dual-CCT" LEDs**

Osram Opto Semiconductors is adding the new Oslux S2.1 to its portfolio for camera flash applications. It combines two chips in different color temperatures, a cold white chip with 6,000 K and a warm white chip with 2,250 K (Dual-CCT), providing both a multi-chip LED and a lens for the first time. This not only saves a work step but also produces excellent results. With a maximum deviation of 300 K, the Oslux offers remarkable color fidelity and excellent color uniformity across the target scene.

Perfect flash for the perfect photo  
In video lights and camera flash applications, the integration of two LED chips and a silicone lens on one pc board offers clear benefits for the customer. Now no separate step is necessary for optimum positioning of the lens. This does not only save time but also optimizes the use of the generated light. While dimensions of 5.0x5.0x1.15 mm make the Oslux S2.1 with its lens slightly higher than predecessor models, it requires less space on the board and has a smaller exposed aperture than two single LEDs, making it impressively compact. The silicone lens also allows this module to be reflow solderable, allowing the module to be easily integrated into standard manufacturing flows.

"With the new Oslux S2.1 we were able to achieve very high quality. We have subjected it to both electrical and optically demanding testing and are very happy with the results. It definitely meets our high quality standards," says Fiona Mak, Product Manager at Osram Opto Semiconductors. ■

## LUXEON CoB Core Range Delivers Up To 30,000 Lumens

Lumileds has announced the addition of three new products to its successful LUXEON CoB Core Range to satisfy high lumen output applications such as streetlights, stadium lights and high bay & low bay fixtures. "We now have the ability to address not only 40 W and 50 W applications but up to 100 W and 120 W applications with these high lumen packages, at the same high efficacy as our LUXEON CoB Core Range (Gen 3) products.," said Eric Senders, Product Line Director for the LUXEON CoB Family.



**The LUXEON CoB Core Range (Gen 3) CoBs are compatible with an existing ecosystem of optic, drivers and holders that enable faster time to market of outdoor streetlights, high bay & low bay fixtures**

The high lumen extension of the LUXEON CoB Core Range (Gen 3) features light emitting surfaces (LES) of 23, 29 and 32 mm, nominal fluxes of 8,800, 11,000 and 16,000 lm at drive currents of 1.2, 2.1 and 2.2 A, plus efficacy up to 161 lm/W. The arrays are offered over a color temperature range of 2700 K to 5700 K and CRI of 70, 80 or 90, with an efficient 70 CRI solution in warmer 3000 K for outdoor lighting as well as a special color requirement for studios and stadiums where cool color temperatures and high (>90) CRI are required. The CoBs are mounted on square Metal Core PCBs (MCPCBs), which provide the industry's lowest thermal resistance, enabling smaller heat sinks and optics for lower overall system

cost. "Feedback from many CoB customers indicates that heat sinks alone make up a substantial portion of system cost. By keeping the LES as small as possible and having a low thermal resistance substrate, a smaller heat sink can be used and a good portion of the cost has been removed from the system," said Senders. ■

## Samsung's New Mid-Power LED Achieves 220 Lumens per Watt

Samsung Electronics has begun mass producing a new mid-power LED package, the LM301B, which features the industry's highest luminous efficacy of 220 lumens per watt. Samsung was able to achieve its industry-leading efficacy (@ 65 mA, 5000 K, CRI 80+) by incorporating an advanced flip-chip package design and state-of-the-art phosphor technology. The package is well suited for a range of LED lighting applications including ambient lighting, downlights and most retrofit lamps.



**Samsung Achieves 220 Lumens per Watt with New LM301B Mid-Power LED Package**

Samsung Electronics has begun mass producing a new mid-power LED package, the LM301B, which features the industry's highest luminous efficacy of 220 lumens per watt. The package is well suited for a range of LED lighting applications including ambient lighting, downlights and most retrofit lamps.

Samsung was able to achieve its industry-leading efficacy (@ 65 mA, 5000 K, CRI 80+) by incorporating an advanced flip-chip package design and state-of-the-art phosphor technology. The LM301B's flip-chip design uses a highly reflective layer-formation technology to enhance its light efficacy at the chip level. Also, a complete separation between its red phosphor film and green phosphors allows minimal interference during the phosphor conversion process, resulting in higher

efficacy than conventional phosphor structures. These combined technology enhancements enable a 10-percent increase in overall efficacy compared to competing 3030 platform packages without compromising on premium-quality light output.

“With our LM301B, we are able to deliver even greater mid-power value and help lower the total cost of ownership for LED lighting manufacturers,” said Jacob Tarn, Executive Vice President of LED Business Team at Samsung Electronics. “Thanks to advancements like the LM301B, Samsung will continue to drive innovation in next-generation LED technologies.” ■

## Cree’s XLamp CXA2 LEDs Set New Performance Standard

CXA2 LEDs deliver the best reliability, highest efficacy and new premium colors including high fidelity (98 CRI) and specialty color points with up to 50% higher efficacy than LEDs of similar sizes and light quality. The CXA2 Standard Density LEDs deliver up to 10% higher light output levels across all CRIs and light emitting surface sizes. Customers can upgrade existing designs and sell to color quality conscious applications: museums, retail, medical lighting.

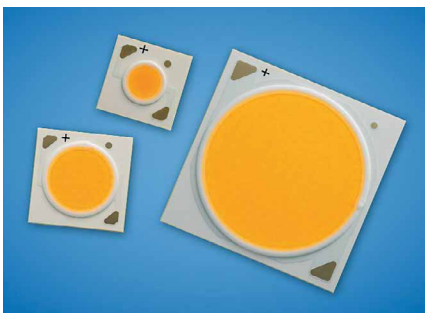

Cree’s enhanced XLamp CXA2 LEDs set new performance standard

“The leading efficacy and excellent reliability of Cree’s CXA2 LEDs allow us to create a complete portfolio of high quality, energy efficient LED track lights,” said Eric Lin, General Manager, Westport International. “With the new premium colors, the CXA2 family will allow us to bring these same advantages to more customers and applications while still leveraging the same, easy-to-use platform.”

The CXA2 Standard Density LEDs now deliver up to 10 percent higher light output levels across all CRIs and light emitting surface (LES) sizes, providing the highest COB LED efficacy for all applications. Further demonstrating Cree’s leadership in reliability and lumen maintenance, the CXA2 LEDs are the only COB LEDs in the industry to have more than 11,000 hours of LM-80 data available. Based on this data, the CXA2 LEDs provide L90 lifetimes well beyond 60,000 hours, even at extreme 105°C test conditions.

“With these enhancements to the CXA2 family, Cree continues to set the benchmark for high-power LEDs through constant focus on improvement,” said Dave Emerson, Cree LEDs senior vice president and general manager. “With the industry’s best lifetime and the new premium color offerings, we’re giving lighting manufacturers the ability to deliver better light and industry-leading performance to more applications than ever before.” ■

## Topled E1608: The New Standards in Miniaturization

More than 25 years ago, the Topled set a standard as the first surface-mountable LED. Osram Opto Semiconductors now presents the latest generation, the Topled E1608, which has a package that is smaller than its predecessor models by factor 20. Despite this considerable miniaturization the low-power LED is bright, reliable and robust. The compact Topled offers greater options and greater design flexibility, particularly for car interior applications.



The new Topled E1608 LEDs combine a smaller package with exceptional versatility to meet an extremely wide range of customer requirements

## Starring CAS 140D!

**NEW**



### This spectroradiometer sets the standard for LED/SSL and display:

- ▲ Superior measuring sensitivity, precision, dynamic range and minimized straylight
- ▲ Constant repeatability in changing ambient temperatures
- ▲ Faster electronics with higher resolution
- ▲ “Plug & Play” accessory identification
- ▲ Proven lab and production software: SpecWin Pro/Light, DLL and LabView

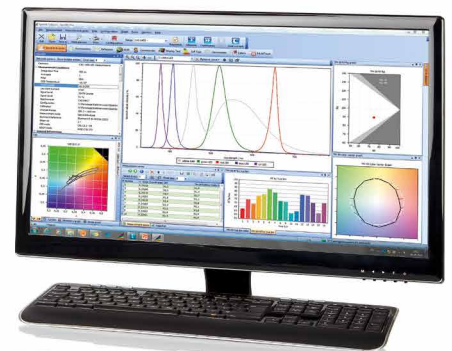

**We bring quality to light.**

ThinGaN, thin film and Sapphire – the new Topled E1608 LEDs are all based on the latest chip technologies. In combination with the latest high-efficiency converters, the low-power LEDs produce outstanding values: At a normal operating current of 20 mA the new Topleds are 3.6 times brighter than their predecessor models. The pure green conversion version, for example, achieves the impressive and unprecedented value of 780 mcd at 10 mA. At the same current it is three times brighter than the classic Topled. For the package, Osram uses tried and tested premold technology, but reduced in size compared to the previous version. The E1608 in the name refers to the more compact package dimensions of 1.6x0.8 mm; by comparison, the standard Topled currently measures 3.2x2.8 mm. At 0.6 mm the height of the E1608 is also considerably less than the previous figure of 1.9 mm.

#### An industry standard of the future:

Thanks to the new package dimensions, the new E1608 can be used for more compact customer systems. The new Topled E1608 LEDs are some of the smallest LEDs in their class. In addition, they offer reliability, a wide selection of colors and impressive values.

“Whatever the customer requirements, they are suitable whether the application is toward to top or bottom of the brightness range. We are assuming therefore that they will gradually become firmly established and may even define a new industry standard”, said Anita Wenzl, Manager LED Automotive Interior at Osram Opto Semiconductors. “These robust LEDs are suitable particularly for the automotive sector for applications such as displays, ambient lighting and backlighting of switches and instruments.”

The new Topled generation will be available in numerous colors – from yellow and orange to super red, white, pure green and true green. The current market launch of six

Topled E1608 products is the start of a whole series of new versions in this product family. In the course of 2017 more new versions will be successively launched. ■

## Lumileds Improves Efficiency and Reliability in Mid Power Packages

With the addition of LUXEON 2835E 3 V to the LUXEON 2835 Line, Lumileds has reset customers' expectations regarding the typical 2.8x3.5 mm package. The 2.8x3.5 mm footprint first gained traction in television backlighting, but now is proving convenient in general lighting applications including downlights, indoor area lighting such as TLEDs, troffers, B12 and A19 bulbs.



**The LUXEON 2835E 3V LED achieves up to 170 lm/W with superior lumen maintenance to that of competing LEDs**

The new LUXEON 2835E 3V raises the standard for this class of product in efficacy and reliability - with efficacy up to 170 lm/W - while meeting the DesignLights Consortium® (DLC) Premium requirements. “Because of the cost sensitivity of this market, other manufacturers have turned to lower cost materials and practices that frankly have impacted long-term reliability,” said Yan Chai, Product Line Director at Lumileds. “Lumileds has maintained its commitment to the highest quality materials including proprietary phosphors, all gold wire bonding, and the tightest process control to deliver the best performance and lumen maintenance.” The LEDs are also DLC Premium V4.1

qualified, giving customers access to maximum energy savings, the highest utility rebates and EnergyStar® certification.

The LUXEON 2835 Line is comprised of LUXEON 2835C for higher output and LUXEON 2835E for lower output ranges. LUXEON 2835E is available in a wide range of color temperatures of 2700 K to 6500 K with a minimum CRI of 80. At the nominal drive current of 60 mA, the LUXEON 2835E can achieve very high efficacy of 170 lm/W and produces 30 lumens at 4000 K and 80 CRI at 60 mA. Alternatively, it can be driven at up to 150 mA to produce > 60 lumens (4000 K and 80 CRI). In addition to this new 3 V version, the LUXEON 2835E is offered in 6 V and 9 V versions for entry level A19 bulbs. Like other products in Lumileds mid power family, the 6 V and 9 V LUXEON 2835E LEDs are hot-color targeted to ensure accurate color representation at application conditions. ■

## Osram IR LED for Augmented and Virtual Reality Systems

Osram's compact IREDS provide the illumination needed by eye-tracking systems in headsets - Osram Opto Semiconductors is launching its smallest side-looking infrared LED to date. The new SFH 4055 is based on the proven Firefly platform, used widely for LEDs in the visible spectrum. The new transmitter, which has a wavelength of 850 nm, is primarily targeted at eye-tracking systems in augmented and virtual reality headsets. Such Eye-tracking systems use multiple infrared LEDs to illuminate users' eyes and capture the light reflected back with camera sensors. This allows these systems to compute the position of the user's pupil and work out what direction the user is looking in. Incorporating this technology into virtual reality (VR) or augmented reality (AR) headsets calls for extremely compact infrared LEDs, tiny enough to fit into



### 14W-40W DALI LED Driver with DIP Switch and Push Dimming

Lifud, an associate member of DiiA (Digital Illumination Interface Alliance), launched its new DALI LED driver LF-GSP040YA applied for LED panel lights, down lights, track lights, etc. And this driver has multiple functions including push dimming, adjustable output current via dip switch and also 0-10V dimming. Besides, this driver is also of flicker-free design with flicker coefficient within 0.5%. It has passed the DALI standard (IEC62386-101,102,207) and is also CE, CB, TUV certified.

For more details, please visit [www.lifud.com](http://www.lifud.com)

**LIFUD**  
LED drivers

[sales@ledfriend.com](mailto:sales@ledfriend.com)

glasses around eyepieces. With a footprint of just 1.0x0.325x0.55 mm, the new Firefly fits the bill perfectly. The LED is a side-looker with an impressively low height of just 0.325 mm.

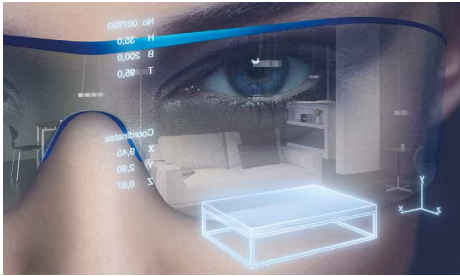

Enabling augmented reality glasses to display exactly the right information at the right time: SFH 4055, Osram's smallest side-looking infrared LED to date, serves as a source of illumination for the eye-tracking systems used in augmented and virtual reality headsets

**Intuitive Interaction, Less Computing Power**

Eye tracking supports entirely new, highly intuitive forms of interaction in VR and AR applications and enables users to control software programs by directing their gaze. For instance, AR glasses can display information that relates specifically to an object that a user has selected.

There is an added benefit for VR systems: They can exploit eye tracking to reduce the amount of computing power they require – a useful capability given the need to render images extremely quickly so as to offer users a realistic experience. Image rendering calls for computers that can deliver a lot of processing and graphics power. With eye tracking, these systems can focus on rendering images at a high resolution in the line of sight and maintain a lower resolution in the periphery.

**Benefits for Optical Touchscreens Too**

Infrared transmitters, lasers and photodetectors from Osram are already in use in VR and AR solutions, and the company's first infrared Firefly will enable it to support new use cases in this fast-growing market.

The SFH 4055 is generally aimed at applications that require exceptionally compact infrared transmitters. Optical touchscreens, for instance, rely on very low-profile, side-emitting infrared LEDs to create a grid of infrared light used for detecting finger positions. ■

**New Lumileds Matrix Platform with Advanced Technologies**

Lumileds announced Advanced Technologies, key components of Matrix Platform which streamline the development of integrated, fully assembled LED light engines. Combined with industry-leading LUXEON LEDs, Matrix Platform Advanced Technologies pave the way for design and manufacturing breakthroughs.

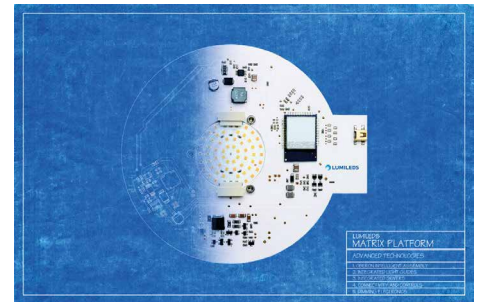

With five new Advanced Technologies added to the Matrix Platform, lighting manufacturers now have access to more competitive advantages to outpace their competition

**Stage Lighting**  
Illuminate your talent



Federal 5050

**Horticulture Lighting**  
Beyond natural light source

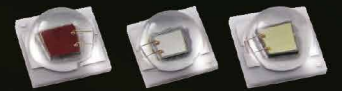

Federal 3535



PLCC 3030



**Shine Every Possibility at Darkness**

Copyright©2017 Edison Opto Corp. All rights reserved.



4F, No.800, Chung-Cheng Rd., Chung-Ho Dist., New Taipei City, Taiwan 23586  
T+ 886 2 82276996 F+ 886 2 82276997 [service@edison-opto.com.tw](mailto:service@edison-opto.com.tw)



### The five new Advanced Technologies added to the Matrix Platform:

- Oberon Intelligent Assembly is the industry's only pick-and-place system that eliminates bins, instead selecting LEDs based on specific test data such as flux or Vf
- Integrated Light Guides are ultra-thin and enable an unprecedented level of light control
- Integrated Drivers, designed to seamlessly incorporate all the necessary electronic components in a way that dramatically simplifies fixture design and reduces space requirements
- Dimming Electronics involve patented circuitry technology to achieve the coveted dim to warm effect
- Connectivity and Controls allows lighting manufacturers to design cutting-edge luminaires that can be controlled remotely, via apps or other devices

Lumileds works with Matrix Platform customers to meet their exacting requirements. By configuring LUXEON LEDs with exclusive Advanced Technologies on rigid or flexible substrates, game-changing lighting solutions are developed. "Customers find that not only does the Matrix Platform approach enable award and market-winning solutions, it also shave weeks if not months off the traditional assembly approach and ensures a product reliability that only Lumileds can guarantee," said Viral Hazari, Matrix Platform Product Manager at Lumileds. For lighting manufacturers seeking faster time to market, greater supply chain efficiency and reduced inventory, Matrix Platform provides the answer. ■

## Seoul Semiconductor - World's Smallest 24W DC LED Drivers

Seoul Semiconductor, a leading global innovator of LED products and technology, has developed the industry's smallest phase-cut DC LED driver series, with a

power density 10X higher than conventional LED drivers. The NanoDriver Series is the world's smallest miniature converter at just 13.5 mm wide, and is available in four versions rated for 16 W and 24 W output power for operating LED lighting with input power of 120 V or 230 V (50–60 Hz). Manufactured with Seoul Semiconductor's original Acrich technology, the NanoDriver Series features an IC directly attached to the substrate, dramatically reducing the size of the converter.



**NanoDriver Series phase-cut LED drivers measure just 13.5mm x 13.5mm x 1.42mm**

"The new NanoDriver Series will be a game-changer for lighting designers by enabling them to reduce the size, weight and volume of their light fixtures," explained Keith Hopwood, executive vice-president at Seoul Semiconductor. "This breakthrough in size reduction for the NanoDriver Series is the result of the company's continuing investment in high voltage LED technology, combined with a unique power topology that results in smaller size, increased efficiency and lower costs."

In the future, Seoul Semiconductor will also launch the MicroDriver Series high performance drivers for LED lighting fixtures from 900 to 2400 lumens. The MicroDriver Series is designed with a miniature package that reduces the size of the converter by more than 10X to enable the integration of the control circuitry with the external driver,

making it possible to mount more light sources on the board, or reduce the size of the board.

The NanoDriver Series requires few external components, and are ideal for downlight, flush mount, track and spotlight fixtures. Their small size enables ultra-thin and novel fixture designs in wall sconces, making conventional lamp replacement possible without the need for a large volume recess for the driver, or a reduction in the light output.

The resulting decrease in the LED drivers' physical size has significant business implications for the lighting industry, giving lighting designers the ability to shrink the size of light fixtures by as much as 20%, which reduces shipping and storage costs. Because conventional LED drivers are both heavy and bulky, they are typically shipped via sea freight from manufacturers in Asia to European and North American fixture companies, with transit times up to six weeks. The NanoDriver Series are small and lightweight enough to make airfreight practical and economical, reducing transit time and making the overall supply chain more flexible and responsive.

The NanoDriver Series is available in four models that have typical efficiencies of 85% and power factor correction (PFC) of <0.9, and are rated for inrush current of <300 mA, with an over-temperature protection feature that limits the LED current at temperatures above 160°C. Operating temperature range is -40° to +70°C (ambient) and -20° to +85°C (at TC point).

The drivers are UL recognized, provide flicker-free, low ripple current operation for phase-cut dimmers, and are compliant to California Title 24, enabling lighting designers to meet the most challenging design requirements, including low flicker, high power factor, Class B EMI and 2kV surge. ■



### New Spectroradiometer CAS 140CT-HR from Instrument Systems

Based on the globally acclaimed CAS 140CT spectroradiometers, Instrument Systems now adds new models specially optimized for narrowband emission sources, e.g. laser diodes. These high-resolution CAS 140CT-HR spectroradiometers combine the demands of high spectral resolution and short measurement times for characterization procedures in production and the laboratory.

[www.instrumentsystems.com](http://www.instrumentsystems.com)



## Inventronics Expands Family of LED Drivers

Inventronics, a top LED manufacturers, is expanding its EUC Series to include dimming capable 40 W models that are ideal for flood, park and architectural decorative lighting applications. The new 40 W series compliments the existing 26 W and 35 W non-dimming series. These products operate over a 108-305 Vac input range while providing exceptional thermal performance. They offer low THD<10% and deliver higher input surge protection with 4kV line-to-line and 6 kV line-to-earth which makes them proficient for outdoor use.



The new 40W models are approved to UL, FCC, CB, CE, TUV, CCC and KS standards. Production quantities of the EUC-040SxxDTM/DVM are available now

Inventronics backs their products with unsurpassed quality, warranty and customer support while providing light fixture manufacturers with the products they need. The EUC Series of constant-current LED drivers is ideal for projects that need luminaires at lower levels of brightness but don't have the budget for programmability or controls. They help to improve costs without sacrificing performance.

The EUC family incorporates input under voltage (IUV) and input over voltage (IOVP) protection for environments where the input line is unstable. DTM versions are IP66 rated and suitable for built-in use while DVM versions are IP67 rated and suitable for independent use. Their compact metal design also offers more flexibility to fit inside a multitude of luminaires and makes them ideal for flood, wall packs, canopy and landscape lighting.

The EUC-040SxxDTM/DVM series offers 4 models that offer isolated 0-10 V dimming and deliver the full 40 W at almost any output current from 500 mA to 1050 mA. They are highly reliable and have a calculated lifetime

to be at least 93,000 hours when operating at 80% load with a case temperature of 75°C. ■

## ams Broadens Smart Lighting Management Offerings

ams, a leading worldwide supplier of high performance sensor solutions, introduced the AS7220 Smart Lighting Manager, which enables a new generation of higher-quality LED-based lamps and luminaires by using closed-loop sensing to maintain more accurate correlated color temperature (CCT) and lumen output while also lowering system bill of materials costs.



**Color and Lumen Maintenance Manager:** Integrated tri-stimulus XYZ color sensor and intelligent driver management in new AS7220 enable high accuracy closed-loop maintenance of LED outputs in industrial, commercial and high-end residential lighting products

Following the launch of the AS7221 smart lighting manager that offered full white color tuning and daylighting features, the latest member of the ams Cognitive Lighting™ Smart Lighting Manager family, the AS7220 combines a precise calibrated-for-life color sensor with an intelligent Cognitive Lighting Engine for standalone closed-loop maintenance of the output from strings of warmer and cooler white LEDs. The result is a luminaire which automatically adjusts for the color shift and lumen depreciation of LEDs as a natural result of aging, operating temperature changes and driver variation over lifetime.

In premium lighting systems marketed to commercial, industrial and high-end residential users, manufacturers must typically rely upon tightly-binned LED combinations to achieve the desired CCT. By employing sophisticated sensor-driven algorithms the ams AS7220 Smart Lighting Manager enables the manufacturer to use a more loosely CCT- and flux-binned range of cool-white and warm-white LEDs to achieve a high and stable quality of light.

**Substantial competitive advantages:**

- Broadening the competitive supply base from which LED production units may be sourced
- Increasing production flexibility and easing the management of LED inventory
- Easing the normal requirement for LED drivers and power supplies to provide precisely regulated outputs, loosening specifications and opening the supply base of those components

The AS7220 is easy to integrate into LED lighting system designs. After the desired CCT and/or full-output lumen values are programmed into it on the production line, it autonomously implements closed-loop color and output control of the LEDs inside a luminaire or lamp. Control of the power supplied to LED strings is implemented via either digital switching of multichannel power supplies, or through a combination of PWM current steering combined with an analog or digital output to standard single-channel 0-10 V or PWM-input dimming ballasts or drivers.

“A continuing challenge in the LED lighting industry is to deliver precisely the same color and output not only over changes in operating temperature, but over the years of service life that customers expect”, said Tom Griffiths, Senior Marketing Manager at ams. “While LEDs are well characterized for their first years of operation, longer term predictive models reveal variability in color and brightness. In addition, LEDs are evolving so fast that the same parts are unlikely to remain the cost-effective choice for the same model of luminaire even as little as one year after going into production, introducing still more variation from light to light.

By adding closed-loop sensing to their product's architecture, luminaire manufacturers free themselves from these technology and supply constraints, lowering bill-of-materials costs and gaining both consistency and a wider basis for component selection, while delivering more precise lighting quality over lifetime”, he said.

The AS7220 is pre-configured for optional operation with an external ams ambient light sensor to additionally provide for autonomous daylight harvesting using standard 0-10 V dimming inputs. The Smart Lighting Manager also provides a direct interface to standard occupancy sensors to enable intelligent dimming control and energy-saving schemes.

Accurate and stable CCT control is enabled by the AS7220's industry-first embedded tri-stimulus CIE XYZ color sensor, which directly maps the sensor channel data to the CIE 1931 color space. Nano-optic interference filters deposited on the die of AS7220 devices offer high stability and virtually no degradation over time and temperature. The sensor system's LGA package, which measures just 4.7x4.5x2.5 mm, includes a built-in aperture with a  $\pm 20.5^\circ$  field of view. Using logic capabilities integrated into the device, the chip is able to deliver factory-calibrated CCT values typically accurate to within .002 du'v' (approximately 2-3 Macadam steps) across its -40 to +85°C operating temperature range. ■

## New LUMAWISE Drive LED Holder from TE

TE Connectivity (TE), a world leader in connectivity and sensors, is unveiling the LUMAWISE Drive LED holder Type Z50 for chip-on-board (COB) LEDs. The new LUMAWISE Drive LED holder Type Z50, used in track and spot lighting, integrates the holder and driver into a single package that offers lighting designers the possibility to develop compact, better-looking and more cost-effective lighting products.



The LUMAWISE Drive LED holder adds a 48 VDC powered constant-current LED driver to the same form factor as the Zhaga-compliant range of LUMAWISE LED holders for COB LEDs

TE's LUMAWISE Drive LED holder Type Z50 is well-suited for track and spot lighting

because it integrates a 48 VDC powered constant-current LED driver into the same form factor as TE's popular 50 mm diameter Zhaga-compliant range of LUMAWISE LED holders for COB LEDs. Until recently, most LED drivers have been housed in separate boxes, often larger than the lamp itself, mounted to the side of the luminaire and remote to the COB light source. This configuration required wiring between the light source and driver, creating design and manufacturing complexity for the designer. TE's new holder reduces that complexity and allows more flexibility for lighting design.

TE is working on several versions of the LUMAWISE Drive LED holder – a simple on/off model, a 0-10 V dimmable type, and a version with Digital Addressable Lighting Interface (DALI) dimming. All three configurations are planned in 350 mA, 500 mA, 700 mA and 1050 mA versions at 36 VDC outputs. Each of these drive currents will work with common COB sizes of 16x19 mm, 19x19 mm, 20x24 mm and 24x24 mm making the LUMAWISE Drive LED holder suitable for use with a broad range of COBs offered by LED manufacturers. ■

## B.E.G. Controls - PureColor, Human Centric Lighting Sensor

B.E.G. Controls LP, the North American affiliate of Brück Electronic GmbH (B.E.G.), introduces the world's first standalone occupancy sensor with the ability to change the color temperature of an LED fixture to match a person's circadian rhythm.



B.E.G.'s PureColor is an all-in-one unit that combines a standalone occupancy sensor with the ability to adjust the color temperature

Known as PureColor, this all in one unit combines both astronomical time keeping and motion detection giving it the ability to both adjust the color temperature of the fixture and maximize energy savings. PureColor also includes an adjustable photocell for advanced daylight harvesting and the ability to manually adjust the light level with a momentary wall station.

All of the settings of the PureColor can be adjusted through a wireless connection using either an Android or iOS app. PureColor works with the open DALI protocol allowing any fixture manufacturer to create HCL fixtures.

"Multiple studies have shown the health benefits of Human Centric Lighting especially when it comes to healthcare, nursing home and educational applications.", says Michael "MJ" Johnson B.E.G. Controls, VP of Sales and Operations. "We are proud to be at the forefront of this important advancement." ■

## EnOcean Launches Easyfit Wall Switches for BT Lighting Systems

Technology provider EnOcean now offers wireless and self-powered Easyfit switches for Bluetooth lighting systems for worldwide usage, enabling maintenance-free, ready-to-use LED lighting applications based on energy harvesting technology.



Easyfit switches for Bluetooth lighting systems: Easyfit Single / Double Rocker Pad for BLE – ESRPB/ EDRPB (left) and Easyfit Single/ Double Rocker Wall Switch European Design for BLE – EWSSB / EWSDS (right)

The Easyfit product line includes wireless and self-powered wall switches based on Bluetooth Low Energy radio standard for LED

### XLAVP Series:

#### Linear Lighting Pro Constant Voltage Dimmable LED Drivers

IXLAVP100 is a universal input (90-305 VAC), 100 Watt phase dimmable LED driver with constant voltage output. Developed for linear lighting applications, this LED driver series comes in UL Listed Class 1 and Class 2 types and features patent pending, deep dimming technology with 0-100%, flicker free dimming and wide compatibility with phase-cut LED dimmer switches such as TRIAC/ELV and SCR type dimmers. Dimming is synchronized and load independent allowing for uniform light output for small and large installations.

<http://www.grealpha.com/>





lighting systems for use in modern lighting control worldwide. Wireless, easy to retrofit and maintenance free, the Easyfit wall switches are helping make LED lighting solutions more energy-efficient, more flexible and lower in cost. Combined with self-powered Bluetooth lighting systems from Casambi, Silvair and Xicato, Easyfit wall switches offer lighting installers the benefits of maintenance-free, freely easily positionable and ready-to-use solutions, allowing flexible control as well as intuitive usage.

“By adding the Easyfit product line to our portfolio, we have taken another important step toward modern LED lighting control for worldwide usage,” explains Andreas Schneider, CEO of EnOcean. “Wireless and self-powered Easyfit wall switches help to increase energy efficiency, save costs and meet regulatory requirements. EnOcean now enables lighting installers to unlock the full potential of LED lighting systems with simple, easy to install, maintenance-free switches based on our proven energy harvesting technology.”

#### Easyfit switches for Bluetooth lighting systems

EnOcean now offers wireless and self-powered wall switches for Bluetooth lighting control systems. The Easyfit Bluetooth Low Energy (BLE) switches are available in two different design versions: The Easyfit switch with standardized 55x55mm frame (EWSSB/EWSDB) allows installers to easily replace any 55x55 switch frame from a number of renowned manufacturers such as BERKER, GIRA, Jäger Direkt, JUNG and MERTEN. The second design is the Easyfit switch for North America (ESRPB/EDRPB).

The self-powered and wireless Easyfit switches can be commissioned by Near Field Communication (NFC) to allow simple or complex lighting scenes and effects, and enable easy, flexible installation of lighting applications. The wireless Easyfit switches are maintenance-free as they do not require batteries, freely positionable and allow flexible control as well as intuitive usage.

Easyfit BLE switches are supported by Casambi, Silvair and Xicato, offering self-powered control solutions for 2.4 GHz BT lighting systems.

Casambi has integrated a support for the Easyfit switches to work seamlessly within Casambi’s Bluetooth networked lighting controls. Equipped with NFC technology, the Easyfit wall switches enable fast and simple commissioning and allow controlling individual luminaires, groups of luminaires, scenes and animations in Casambi lighting control solutions.

With the Mesh Stack, Silvair provides a wireless communication engine for robust and fully scalable mesh lighting. The integration of Easyfit switches into the Mesh allows an optimal, maintenance-free control of lighting systems with low latency, even in high-density lighting networks. It can be updated over-the-air to become compliant with the upcoming Bluetooth Mesh standard following its adoption.

Xicato’s XIM Gen4 LED lighting modules plus EnOcean’s Easyfit switches for Bluetooth Low Energy are ideal for retail and commercial applications requiring California Title 24 compliance. The combination of the energy harvesting wireless Easyfit switches with the features of Xicato’s LED lighting modules allows simple or complex lighting scenarios, and enables flexible installation. These self-powered lighting solutions are used in some of the world’s finest museums, retail stores, hotels and residences. ■



## Radiance – No Shadowing

For perfect light distribution, connection technology is required that has the market’s smallest dimensions and can be flexibly integrated into LED modules – like WAGO’s SMD PCB Terminal Blocks. **We Connect Your Light.**

[www.wago.com/smd](http://www.wago.com/smd)

**WAGO**

## Instrument Systems - New Product Portfolio for UV Measurement

Instrument Systems' new UV measurement solution consists of a spectroradiometer from the proven CAS series as well as a series of integrating spheres specifically designed for UV sources. It measures samples with various radiation spectra in the UV-A, UV-B and UV-C range starting at 200 nm.



Instrument Systems' new UV measurement solution consists of a spectroradiometer from the proven CAS series as well as a series of integrating spheres

The integrating spheres specifically designed for UV sources use polytetrafluoroethylene (PTFE) as a reflective material. PTFE is highly reflective in the UV spectral range down to 200 nm. It therefore allows high throughput, even for challenging UV-B and UV-C emitters where other reflective materials, such as barium sulfate (BaSO<sub>4</sub>), have an extremely low throughput.

The combined use of these PTFE integrating spheres and Instrument Systems' high-end CAS array spectroradiometers permits high sensitivity measurements with high dynamic measuring range.

The all-in-one system is suitable for laboratory applications as well as in production environments. It reliably and precisely measures samples with various radiation spectra in the UV-A, UV-B and UV-C range.

All Instrument Systems UV measurement solutions with PTFE integrating spheres are delivered with a PTB traceable calibration. ■

## CAS 140D: The New Reference Instrument for Spectral Measurement

Instrument Systems' spectroradiometer CAS 140D combines all the advantages of the proven CAS 140CT in terms of measurement accuracy and reliability with sustainable technical optimizations to enhance repeatability and stability in every environment. Due to its improved optical and mechanical construction the instrument is smaller, more functional and simpler to integrate into existing measurement environments.



The spectroradiometer CAS 140D combines all advantages of the proven CAS 140CT with technical optimizations to enhance repeatability and stability

# LED Emergency Solutions

Reliable, intelligent, integrated.  
Fulham takes LED emergency  
lighting to the next level.

**FULHAM**  
Lighting... Global. Intelligent. Sustainable.

**FULHAM**  
HOTSPOT LED



### HotSpot Plus: The All-in-One Driver Solution

The first fully integrated programmable LED driver, emergency LED driver, and replaceable backup battery. A revolutionary design that reduces costs, simplifies installation, and brings emergency capability to smaller luminaires.

Contact us today to learn more about  
Fulham's innovative LED solutions

#### Europe

sales.eu@fulham.com | +31 72 572 3000

#### North America

order@fulham.com | +1 323 599 5000

[www.fulham.com/hotspot](http://www.fulham.com/hotspot)

Visit us at LED Professional Symposium + Expo, Stand T09.

Automatic accessory recognition enables fast and simple changing of a wide range of measurement adapters. In laboratory and production environments the new plug & play principle ensures a high degree of process reliability. The system automatically recognizes the connected accessories and ensures that only current and valid calibrations are used. Another new feature of the CAS 140D is the changeable interface between the spectrometer and control computer. Depending on the measurement task at hand, it can be exchanged simply via plug-in module with an USB, PCIe or Ethernet interface.

The CAS 140D is suitable both as a reference instrument in national calibration labs and for continuous operation in production. A wide selection of accessories supplements the array spectrometer to form complete system for all spectroradiometric and photometric measurement tasks. ■

## High Conductive Foils Enabling Large Area Lighting

Fraunhofer Institute for Organic Electronics, Electron Beam and Plasma Technology FEP as one of the leading partners for research and development for surface technologies and organic electronics and Sefar AG, a leading manufacturer of precision fabrics from monofilaments, developed a roll-to-roll processed large area flexible OLED during a joint project.

Large area OLED lighting is an attractive technology for various applications in residential, architectural and automotive lighting segments. Sefar developed high conductive, transparent and flexible electrode substrates enabling large area homogenous lighting which is demonstrated by Fraunhofer FEP in a roll-to-roll (R2R) process.

OLED for lighting applications enables new form designs (large area, flexible, lightweight and thin), is one of the closest light sources to natural light and has a low energy consumption.

“The new electrode substrate SEFAR TCS Planar is manufactured in a roll-to-roll process”, explains Roland Steim, project manager at Sefar, “It is a foil like substrate with a very high conductivity of up to 0.01 Ohm/Square and a transparency above 87%. This outstanding high conductivity originates from embedded metallic wires with a diameter of currently 40 µm.”

These metal wires reduce resistive losses in the transparent electrode substrate, which allows the design of larger and more homogeneous lighting solutions compared to conventional substrates like pure ITO. In addition, the embedded metallic wires are robust



**Hightech am Tiroler Lech**

High End Optical Development and Production

Meet us at booth B1

LpS 2017  
LED SYMPOSIUM + EXPO

**kdg opticomp.** Your technology partner with streamlined processes for high-precision customized optics

kdg opticomp GmbH, 6652 Elbigenalp 91, Austria  
Tel. +43 5634 500 700, [opticomp@kdg.at](mailto:opticomp@kdg.at), [www.kdg.at](http://www.kdg.at)



A roll-to-roll process is the key to affordable large area flexible OLEDs



## New High-Performance Optical Silicones from Dow Corning

Introducing a new family of moldable optical silicones that give LED lighting designers and manufacturers greater freedom. Dow Corning® MS-40XX Moldable Silicones provide next-generation solutions for optical parts and secondary lenses. Enabling innovative lighting designs, these materials are part of an award-winning portfolio of high-performance moldable optical silicones. Visit us at LpS 2017, #D2.

[dowcorning.com/lighting](http://dowcorning.com/lighting)



against bending of the substrate and less brittle than thick ITO layers on films. One challenge in the development of SEFAR TCS Planar was getting the surface as smooth as possible while parts of the metallic wires still emerge on the surface forming the electrical contact to the OLED.

Fraunhofer FEP has huge experiences in roll-to-roll processing of OLED and offers research and development services from concept studies to sample production in the field of R2R fabrication of organic-based devices on flexible substrates for industrial partners.

Stefan Mogck, head of department roll-to-roll organic technology at Fraunhofer FEP summarizes: "We processed the OLED in vacuum in a roll-to-roll process on SEFAR TCS Planar substrates with a specific developed drying process and barrier film lamination. Altogether we deposited the OLED 30 m in length and 30 cm in width and OLED size up to 250 cm<sup>2</sup>."

#### About Sefar AG

Sefar AG is the leading manufacturer of precision fabrics from monofilaments for the screen printing and filtration markets. Sefar products are used in a wide variety of industries, reaching from electronics, graphics, medical, automotive, food and pharmaceutical applications to aerospace, mining and refining, and architecture.

#### About Fraunhofer FEP

The Fraunhofer Institute for Organic Electronics, Electron Beam and Plasma Technology FEP works on innovative solutions in the fields of vacuum coating, surface treatment as well as organic semiconductors. The core competences electron beam technology, sputtering and plasma-activated deposition, high-rate PECVD as well as technologies for the organic electronics and IC/system design provide a basis for these activities. ■

## Innovation Extends the Lumen Extraction Limits of RGB and White LEDs

EVATEG Energy Efficient Electronics and Lighting Technologies Center recently demonstrated a new optical extraction technology for RGB and phosphor coated LEDs to extend the limits over 53%.

This new technology has been studied over the last 6 years with a group of researchers under Dr. Mehmet Arik of Ozyegin University who has over 17 years of experience including 11 years at GE Global Research Laboratories in New York, USA. While conventional LED packages consist of silicone-phosphor mixture over the chip, causing some significant optical losses due to refractive index mismatching, local heat transfer as well as local phosphor heating issues; EVATEG's novel idea enhances the light extraction by applying the phosphor away from the chip with remote coating under glass dome.

This novel idea brings the following key advantages over conventional approaches:

- Provides an effective cooling of LED light engines abating local temperature non-uniformities
- Simplifies complex lighting system designs
- Reduces the thermal resistance between the chip and heat sink significantly and leads to high lumen extraction
- Key enabler technology for advanced IoT features for lighting systems
- Lowers the junction temperature with an effective cooling of chip and phosphor while increasing the lumen output and lifetime
- Higher conversion efficiency in phosphor with decreasing temperature
- Eliminates color shifts due to temperature overshoots
- Enables a better refractive index matching reducing optical losses

EVATEG's new approach decreases the junction temperature with optothermal liquid cooling technologies. An extensive

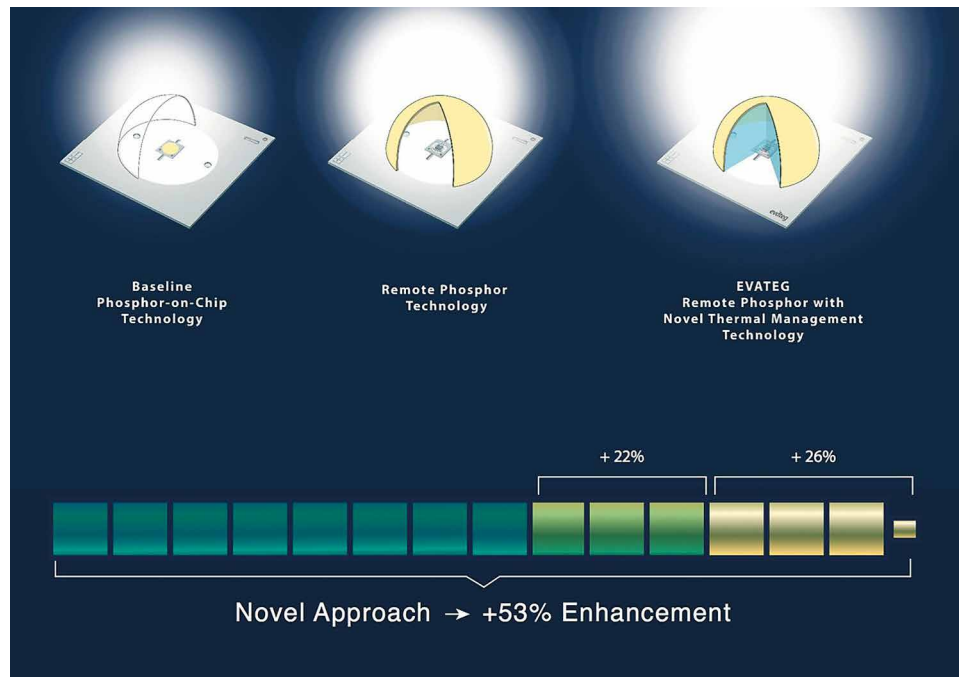

A combination of remote phosphor with an innovative thermal management approach adds 53% lumen extraction efficiency



### RECOM Super-Flat 11 and 13 mm High LED Drivers Are Ideal for Furniture, Cove, and Cabinet Lighting

RECOM has released an entire family of super-flat constant-current and constant-voltage LED drivers suitable for stand-alone LED luminaires where space – especially height – is at a minimum. The reduction in height also comes at a reduced price, but the performance quality is not compensated - the LED drivers are short-circuit and overload protected, CE, CB, and ENEC certified, have an excellent standby power, and come with a full 3-year warranty.

[www.recom-power.com](http://www.recom-power.com)

[info@recom-power.com](mailto:info@recom-power.com)

**RECOM**  
LIGHTING

comparison between the baseline (conventional LED packages) with air filled, fully silicone cured and optothermal fluid filled separately has shown an increase over the lumen output as 23%, 40% and 53% over the baseline respectively. ■

## Narrow Emission QD's Improve Warm White LED Performance and Improve Color Rendering

In an interview with LED professional at the Lightfair International in Philadelphia, Dr. Jy Bhardwaj, CTO at Lumileds, explained the advantages of the Quantum Dots technology. Lumileds will launch the first QD LED within the next few months.



**Industry breakthrough: Narrow emission QD's improve warm white LED performance and improve color rendering**

Dr. Bhardwaj pointed out that red QDs with tunable peak emission and narrow FWHM in combination with a conventional phosphor material can lead to LED conversion efficiency improvements of 5% to 15% over commercial phosphor based LEDs at CCTs ranging from 5,000 to 2,700 K.

QD based LEDs have shown promise for over a decade after the first demonstration of color conversion with a blue LED. The combination of narrow full width at half-maximum (FWHM) and tunable peak wavelength of red QDs has resulted in 17% efficiency improvement of QD based LEDs compared to commercial red nitride based LEDs. The LED stability with 20 W/cm<sup>2</sup> of incident blue light and QD temperatures over 110°C have passed 3,000 h and continue to show no degradation.

CE and CRI are improved by eliminating the light outside the photopic (eye) response. Up to 10-20% performance improvement especially for CRI 90 can be reached.

"The QD emission wavelength can be tuned by the size of the particle. This huge improvement will lead to 50% reduction of the number of LEDs needed for a given system and specification", said Dr. Jy Bhardwaj at the Lightfair International in Philadelphia.

For further information please read the upcoming LpR issues and/or visit the LpS 2017 event on Sept 26-28, 2017 in Bregenz ([www.LpS2017.com](http://www.LpS2017.com)). ■

# EPISTAR

Standing on the shoulder of giant

SEE FURTHER



Co-activation  
**SERVICE**

Learn more about our  
Co-activation Service Model

Epistar Corporation  
21, Li-hsin Rd., Hsinchu Science Park,  
Hsinchu 300, Taiwan  
T : +886 3-567-8000 F : +886 3-579-0801  
[www.epistar.com](http://www.epistar.com) E : [sales@epistar.com](mailto:sales@epistar.com)



Website Facebook

## TECHNICAL REGULATORY COMPLIANCE UPDATE



Segment	Product	Standard (Certification)	Region	Technical Regulatory Compliance Information
Lighting	Lamps	Title 20 State Regulated lamps - Guidance document	California.	<p>Title 20 is a part of the California Appliance Efficiency Regulation which states the requirements on performance, testing and marking for California state-regulated LED lamps (SLED), small diameter directional lamps (SDDL), and general service lamps (GSL) manufactured on or after January 1, 2018. As it is an appliance regulation, thus it regulates not only lamps (bulbs) and LED bulbs but, also all types of electrical products including portable fixtures and lighting controls. Below is the quickview on the just published guidance document for the manufacturers, distributors, retailers, contractors, importers and installers for the correct application of Title 20:</p> <ul style="list-style-type: none"> <li>• Meeting the applicable design or performance standards (efficiency standards)</li> <li>• Testing regulated products using the required test methods</li> <li>• Marking the regulated product in accordance with Title 20 Section 1607, and</li> <li>• Certifying the product to the California Energy Commission</li> </ul> <p>Compliance also includes mandatory certification of the regulated products to the Energy Commission and it to be listed on the publicly available database of California Energy Commission's - Modernized Appliance Efficiency Database System (MAEDBS).</p>
Regulations	Luminaires	IEC 60598-2-17:2017	Int.	<p>This second edition of IEC 60598-2-17:2017 which specifies requirements for stage, television, film and photographic studio luminaires (including spot and floodlighting projectors) for use outdoors and indoors, with electric light sources on supply voltages not exceeding 1000 V, cancels and replaces the first edition published in 1984. Below are the significant technical changes with respect to the previous edition:</p> <ul style="list-style-type: none"> <li>• Extension of the applicable scope to all kind of electric light sources</li> <li>• Compliance test for protective shield with impact hammer</li> <li>• Clarifications on thermal and IP test sequence</li> <li>• Markings and warnings to be mentioned</li> </ul>
Regulations	Luminaires	IEC 60598-2-4:2017	Int.	<p>This third edition of IEC 60598-2-4:2017 incorporates now all requirements listed in IEC 60598-2-7. As a result, IEC 60598-2-7 will be withdrawn after publication of this standard. This specifies requirements for portable general purpose luminaires for indoor and/or outdoor use (e.g. garden use), other than handlamps, designed to be used with or incorporating electrical light sources on supply voltages not exceeding 250 V, cancels and replaces the second edition published in 1997. This edition includes various technical changes. A few are mentioned below:</p> <ul style="list-style-type: none"> <li>• To cover all electrical light sources</li> <li>• Introduction of the symbol for luminaires</li> <li>• Modifications in details of the stability test</li> <li>• Modifications on the minimum degree of protection against dust and moisture</li> </ul>
Regulations	Luminaires	IEC 60570:2003+ A1:2017	Int.	<p>IEC 60570:2003+A1:2017 applies to track systems for ordinary interior use for mounting on, or flush with, or suspended from walls and ceilings and may also provide mechanical support of the luminaires. The lighting track systems help to increase the use of spot lighting and as they offer considerable flexibility, since the number, the type and the orientation of luminaires may vary thus, these track systems are not intended for locations where special conditions prevail as in ships, vehicles and the like and in hazardous locations, for example, where explosions are liable to occur. This edition made changes on voltage for SELV and on dimensions in the fig 3.</p>
Lighting	Lamps	Energy Star Requirements	United States	<p>In recent years, EPA has worked with stakeholders to raise the bar for efficient lighting and thus have come up with the Energy Star criteria where product should meet all the requirements to earn ENERGY STAR. This becomes effective from October 1, 2017. These requirements are specific to lamps classified by program as Omnidirectional, directional or decorative in fluorescent (also, including a few types of self-ballasted compact fluorescent lamps) and solid-state lighting sources. To qualify for Energy Star, a product model should meet the Energy Star specification in effect on its date of manufacture.</p>

**Disclaimer:** This information is research work of TÜV SÜD Product Service and is intended for general information purposes only. The content is publishable only after having the consent of TÜV SÜD Product Service. If it is published with any changes, the company is not liable for it. The information is subject to change and all rights for it are reserved by TÜV SÜD Product Service GmbH.

A free training can be arranged for a clear understanding of the upper stated standards.

For further information on the latest upgrades and testing standards and training, please contact [cps@tuv-sud.com](mailto:cps@tuv-sud.com)

# LpS 2017 Proudly Announces Its Stellar Speakers and Event Program

LpS 2017 is proud to reveal this year's event program, for what will be the greatest LpS to date

Joining over 1600 delegates and 100 exhibitors in Bregenz this year will be global experts from industry and research, to focus on multiple lighting applications such as Human Centric Lighting, Transportation, Agricultural, Healthcare and many more.

These chosen specialists will be sharing their future visions, innovative technologies, trend insights and research findings in over 100 carefully selected lectures.

"We have been building up to this for 7 years; LpS 2017 will be something truly special! We are bringing together the very best minds in light, from industry and research, for what I believe will be 3 unforgettable days that will explore and develop the light technologies of tomorrow," Siegfried Luger, Event Director.

Highlights this year will include keynote lectures on the prominent

trends Connected Lighting and Human Centric Lighting. Delegates will hear from the world's foremost expert in Solid-State Lighting, Fred Maxik, and industry trailblazer Jan Denneman, Vice President of Philips Lighting, who will be sharing his visions on "Connected Lighting – A Global View".

Additional sessions will also cover laser lighting, future markets & trends, Human Centric Lighting, light sources and modules, intelligent lighting, IoT and security, materials and components, system qualification and applications.

Hands-On: LpS 2017 offers its attendees the chance to get hands-on and to explore light, and its possibilities. With a series of detailed and informative workshops delivered and led by such internationally renowned companies and organizations as EPIC, Photonics21 and Bluetooth SIG on subjects including

Miniaturization, LiFi, and the potential of Bluetooth and IoT.

Award Winners: The very best technology, products, equipment or services at LpS 2017, one that demonstrates uniqueness, sustainability and the highest-quality in the field of Solid-State Lighting, will be honored with the LpS Award.

LpS is the leading international lighting technologies event for design, testing and production of lighting systems, controls and equipment, showcasing state of the art lighting designs and products. The conference has a long heritage and a trusted reputation for being the event that brings together the very best light technologies experts from around the world and has also received the Austrian Congress Award 2017. ■

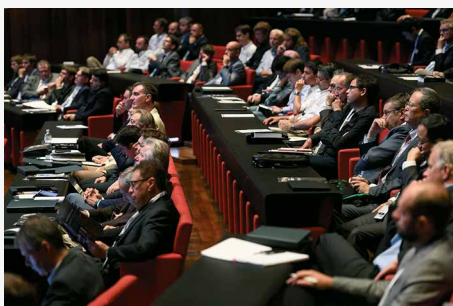

"LpS is a great opportunity for experts in light technologies and research to come together. It allows professionals to share ideas that help to shape and build the future of light."

Prof.Dr. Shuji Nakamura, Nobel Prize winner and the inventor of the blue LED

# CIE Research Strategy on Defining New Calibration Sources and Illuminants

In photometry and radiometry, traceability of measurements requires appropriate calibration sources and transfer detectors. A major challenge is the technological revolution of lighting products towards LED lighting and the ban of incandescent lamps. This raises concern about the availability of incandescent photometric standard lamps in the future while the prices of such standard lamps are already increasing. In addition, calibration conditions should ideally be chosen to be as close as possible to the measurement conditions. Furthermore, the number of LED lighting measurements in laboratories and in the field has significantly increased, while the calibration of photometers is still done using incandescent-based standards. Therefore, it is important to investigate the pros and cons of replacement of conventional standard lamps with new solid-state technology. Peter Blattner and Tony Bergen, Division 2 Director and Secretary respectively, explain how CIE has defined the research topic “New Calibration Sources and Illuminants for Photometry, Colorimetry, and Radiometry” to address these concerns.

Many national and international standards require traceability of the measurements to an internationally-recognized realization of the International System of Units (SI). This is typically done by relating measurement results to a reference through an unbroken chain of calibrations. Calibration means that a device under test is compared to a reference device in well-defined calibration conditions (i.e. environmental conditions, calibration geometries, spectral distribution of the calibration source etc).

In the field of radiometry and photometry, tungsten or halogen based sources are typically used for the calibration of radiometric and photometric devices such as spectroradiometers and photometers. According to the international standard ISO/CIE [1] all photometers are calibrated using a CIE Standard Illuminant A, typically realized by adjusting a tungsten lamp to a distribution temperature of 2856 K. The lamp is aligned on the optical axis at “far-field” to simulate a point source

and the ambient temperature of the laboratory is set to 25°C.

In practice, the measurement conditions might differ significantly from this calibration condition: for example, the calibrated photometer could be used to measure in an LED street lighting installation. In such a situation the spectral distribution, the measurement geometry and the ambient temperature might be significantly different from the calibration condition. These differences will lead to errors which should be quantified and corrected. However even after corrections some uncertainties remains due to the fact the test condition (and the calibration condition) are only known with some degree of uncertainties. In addition, such corrections might be very time-consuming or simply not possible due to the limited knowledge of the test condition and the behaviour of the measurement instrument.

There are different strategies to address this problem and thus reduce the measurement uncertainty. A high quality instrument will be less sensitive to the deviation between the

calibration and test conditions. For this purpose, CIE has defined different quality indices for photometric devices [1]: for example, the general  $V(\lambda)$  mismatch index  $f1'$  describes how well the relative spectral responsivity of the photometer matches the standard relative spectral luminous efficiency function  $V(\lambda)$ . The smaller the value the better the spectral match. This is illustrated by Figure 1, which reports the spectral mismatch correction factors (SMCF) for phosphor-type white LEDs and different values of photometers. The SMCF enables correcting for spectral mismatch for a given specific spectral distribution. However, a correction of the measured photometric value in respect to the spectral mismatch of the photometer is only possible if the relative spectral responsivity of the photometer and the relative spectral distribution of the radiation of the device under test are known. If no correction is applied the uncertainty associated with the spectral mismatch can be estimated from the black lines in Figure 1 showing the upper and lower limit of the correction factor. As an example, a photometer with an  $f1'$  of 6% will



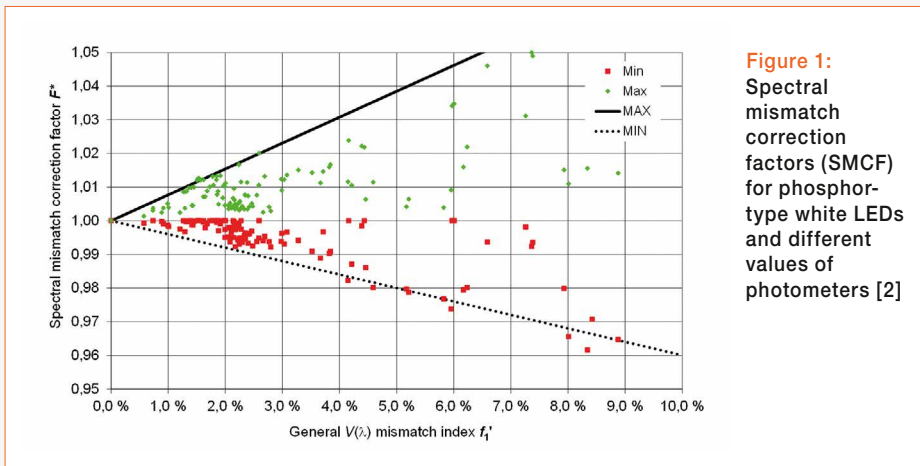

**Figure 1:**  
Spectral mismatch correction factors (SMCF) for phosphor-type white LEDs and different values of photometers [2]

contribute a maximum of about 4.8% to the uncertainty when measuring phosphor-type white LEDs. In most cases this is the dominant uncertainty parameter in the measurement of LED lamps and luminaires when the measurements are performed using photometers. According to the international LED measurements standard (CIE S 025, [2]) the measurement uncertainty shall be reported as part of the measurement results.

To further reduce the uncertainty, the calibration condition should be closer to the measurement condition. Hence if the photometer is used to measure mainly white LED sources it might be reasonable to consider a white LED as calibration source.

However, some challenges must be considered when defining an LED as a calibration source: in particular, the fact that there is not a single spectral power distribution that would be representative of all white LED sources. Thus, it may be necessary to consider a family of standard LED illuminants to represent these different applications. This is a similar principle to what has been done in CIE 015:2004, where selected spectral distributions of different fluorescent lamp designs are standardized as lamp spectra F1 to F12.

To address the issue, the CIE technical committee TC 1-85 is presently updating the fundamental CIE publication 15:2004 Colorimetry. It is intended to include a set of typical white light LED reference spectra referenced as Illuminant L1, L2, etc., of various types (phosphor based, hybrid,

RGB, violet pumped). For this purpose, the reportship DR 1-62 has been established to select typical available LED spectra. This work is supported by the European research project EMPIR 15SIB07 PhotoLED [3] that collects and analyses a large number of spectra of SSL products on the market. The selection methodology and the selected spectra will be presented in a dedicated workshop at the next CIE midterm meeting [4]. Parallel to the Division 1 activities, CIE Division 2 has set up the reportship DR 2-71, which will select a subset of spectra that could be used to define new calibration reference spectra and consider possible implications of the new spectra. Presently CIE Standard Illuminant A is used in different contexts, such as calibrations of photometers and in the definition of the quality indices. Therefore, it is important to investigate the advantages and disadvantages of replacement of conventional standard lamps with new solid-state technology. There needs to be availability of sources that are able to reproduce the nominal spectra power distributions. It is therefore crucial to characterize possible LED standard lamps carefully.

The CIE research topic is not only limited to define new LED based calibration sources for general lighting application but it also outlines the need for calibration sources for spectral quantities in extended wavelength ranges (UV to NIR) as replacement of existing halogen-based sources. Alternative types of sources could be considered, including new broadband LED sources, laser-driven light sources,

white-light laser sources, and tuneable laser sources for detector-based calibration.

In particular the research topic lists the following key questions to be addressed in near future:

- What spectral range is necessary for LED standard sources and what composition of LEDs should be used to realize such a standard?
- What would be the best reference spectrum (spectra) based on LED products for general-purpose white lighting LEDs, considering that these products are still in evolution?
- What are the alternative sources to calibrate spectroradiometers over extended wavelength ranges, including NIR and UV?
- What are the impacts due to the changes to new calibration sources and in the definition of new (standard) illuminant(s)?

CIE invites all interested partners including university research laboratories, lamp and measurement instrument manufacturers, private and national calibration and testing laboratories to conduct the necessary research to address these research questions. CIE calls on national and international research funders to create opportunities that will enable the research community to provide this necessary support to the CIE. The results of such research can best be published at CIE conferences and discussed at CIE workshops or Division meetings. The next opportunity is the CIE midterm meeting on October 22<sup>nd</sup> to 25<sup>th</sup>, 2017 in Jeju Island, Korea [4]. ■

#### References:

- [1] ISO/CIE 19476:2014(E): Joint ISO/CIE Standard: Characterization of the Performance of Illuminance Meters and Luminance Meters
- [2] CIE S 025/E:2015: Test Method for LED Lamps, LED Luminaires and LED Modules
- [3] Future Photometry Based on Solid State Lighting Products, <http://photoled.aalto.fi/>
- [4] <http://cie2017.org>

# Tech-Talks BREGENZ - Jamie Singerman, Future Lighting Solutions



## Jamie Singerman

Jamie Singerman joined Future Electronics in May 1996, in the capacity of Corporate Vice-President – Worldwide Marketing. He joined Future following a successful career in consumer electronics distribution for over 14 years. In 2000, Mr. Singerman assumed dual responsibility as Vice-President of Human Resources as well as Worldwide Marketing, for the Corporation. In 2004, Mr. Singerman took on the responsibility of Corporate Vice-President - Worldwide, Future Lighting Solutions (FLS), a division of the Corporation devoted to implementing solid-state lighting technologies. Having traveled extensively, his efforts have been focused on market development, customer acquisition and strategic supplier initiatives. He has been instrumental in developing FLS into a global leader in the solid-state lighting arena.

We recently sat down with Jamie Singerman, Worldwide Corporate Vice President, and Patrick Durand, Technical Director for Future Lighting Solutions, a leading provider of Solid-State Lighting technologies, engineering expertise and online simulation and design tools, to discuss the company's differentiators and their views on the ever changing lighting market.

**LED professional:** Thank you, Jamie and Patrick, for this opportunity to talk to you.

**Jamie Singerman:** Our pleasure!

**LED professional:** The first thing we would like to ask you for our readers is an overview of Future Lighting Solutions and the value proposition of your company.

**Jamie Singerman:** We have a long history in the Solid-State Lighting business. In fact, we were one of the first enablers of Solid-State Lighting high power, white LEDs, back in 2000. We realized that there was an emerging need that was very different from the traditional customer base we were serving as part of Future Electronics, and based on that need, we created a division called Future Lighting Solutions. Future Lighting Solutions is solely devoted to enabling customers to convert from traditional light sources to Solid-State Lighting. Frankly, our entire business model is built upon listening to customers - identifying their needs and their challenges - and then developing an infrastructure to serve them, whether that means people, tools or a back-end supply chain model. In this regard, we have developed four key value propositions for our customers.

**LED professional:** I see. So your business model has evolved and is built around these values. How do you define these in detail?

**Jamie Singerman:** The first critical element is to be able to provide the customer with a comprehensive system level portfolio. We are focused on addressing the needs of the customer at the system level. What are they trying to build? Is it a down light? Is it a troffer? How do they build that fixture? And what performance levels do they need to achieve? We make sure we have the right components and technologies to enable them to build the complete fixture in an efficient manner, considering cost, component selection, and in terms of time to revenue. In this business it's about agility of

execution, speed to market and being competitive. Being able to deliver the full system to the customer is also efficient both for their engineering and procurement people.

**LED professional:** Beside the system level portfolio, it's also a question of the system-level expertise, isn't it?

**Jamie Singerman:** Yes, the second core value of our model is to offer our customers our cumulative years of lighting experience and expertise. Our job is to help the customer leverage the knowledge we have and understand the design options available to them.

We spend a great deal of time and effort training our people. Our strategy is to train at the system level to enable the customer to design their fixtures in as short a time period as possible. Nearly all of our system-level training is done in-house. Suppliers can train us on their portfolio, but equipping our people to support designs at the system-level is how we add value to the customers. Our lighting engineers are an extension of the customers' in-house resources.

**LED professional:** And the third core of your model is design-in support. Please elaborate.

**Jamie Singerman:** We have created an exclusive suite of more than 25 design tools aimed at accelerating time to revenue by assisting engineers to design lighting systems quickly and efficiently. Some of our tools enable complete system level design decisions, effectively building a bill of materials for the engineer, including the light source (LED, engines, module), driver, optics and thermal management solutions. We have over 15,000 LEDs characterized in our tools, so customers can understand the impact their decisions can have on their chosen components and systems. Our tools are regularly updated with new products and kept current by our team of professional lighting engineers located in our lighting labs in Montreal, Shenzhen and The Netherlands.

**LED professional:** And what about the fourth area of your value proposition, in addition to the portfolio and the knowledge support?

**Jamie Singerman:** The importance of supply chain management in the lighting space should never be underestimated. We take great pride in offering our customers comprehensive global supply chain solutions that are individually customized to their specific needs and goals. Much of this industry is project based, and many of our customers cannot plan their forecasts like in other businesses. It's simple; if you win a contract, you have short lead times to manufacture and deliver; yet lead times at the component level can be significantly longer. Our strategy is to manage their back end requirements. Inventory risk is a huge concern for customers. They don't want to sit with a significant amount of inventory that they may or may not need. We carry a deep and broad inventory of all the components in a design, so that when the customer wins the order, we're able to deliver whatever they need in a very timely fashion. We can manage multi-site scenarios globally and via a secure portal, customers have full visibility to inventory, to their unique programs and can manage their requirements real-time.

**LED professional:** Impressive and very customer-centric, I must say. Together with the technical and supply chain risks, there's also the financial risk in projects. How do you deal with this?

**Jamie Singerman:** We help our customers manage their financial risk and profitability by effectively being their inventory partner. We will bond inventory for them for months, ensuring they can pull what they need, when they need it. We therefore lower their carrying costs, help improve their cash flow, and minimize their bad and excess inventory. We view inventory as an investment in our customers - not a liability, like most other business models. We can also be very flexible on offering extended payment terms to further assist in their cash flow

In addition to their online design tools, Future Lighting Solutions provides technical services for their clients in their three Lighting Resource Centers in Montreal, Shenzhen, and the Netherlands

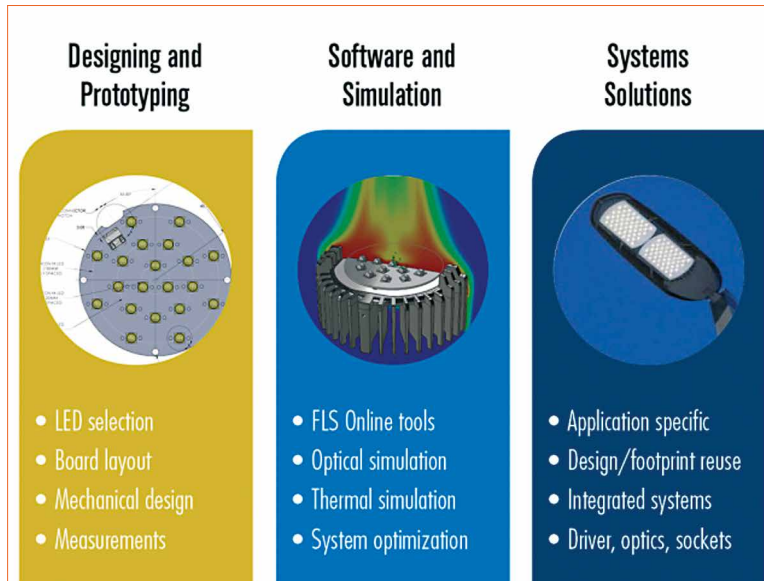

management. Another investment in our customers.

**LED professional:** How do you handle the situation when a customer has a design with a specific component and he wants to run it for a longer period of time but the product has been obsoleted by the manufacturer?

**Jamie Singerman:** This situation comes up particularly in applications that are highly regulated such as in medical applications, where customers need to be able to provide continuity of supply for the same device over an extended period of time. We can absolutely work with the customer and hold parts, frankly speaking, for years, if that's what's required. The aerospace business has some of those requirements as well as other specialty markets. As I mentioned earlier, our model is designed to listen and respond to the voice of the customer.

**LED professional:** What applications are Future Lighting Solutions focusing on?

**Jamie Singerman:** Fundamentally, our customer base is comprised of fixture makers and other specialty lighting makers such as torch/flashlight. Whether it's an indoor fixture, outdoor fixture, or specialty applications like medical, or emergency vehicles - all of these

customers face the same challenges: Being able to access the right portfolio, building the right solution and getting to market quickly. Our strategy is to always have a solution for those customers and their fixtures portfolio.

**LED professional:** New applications are coming up, like horticulture lighting or UV applications for new niches. Can you talk a little about them?

**Jamie Singerman:** This business is always about looking forward. We are always looking at where the market is going in terms of applications and technology. Horticulture is a burgeoning opportunity now and we are also looking very seriously at the UV A, B and C markets. Although they are smaller markets today, the annual growth is expected to be in excess of 40% per year for the next four to five years. This growth is inevitable. The technology is ready; the applications are there, and part of our responsibility is to be ahead of the curve, so that when a customer wonders, "How can I leverage this technology to grow my business?" we are their partner of choice because we already have the tools, the products, the capability and the knowledge to assist them.

**LED professional:** Do you offer design support for these new application areas?

**Patrick Durand:** For both markets, we are already building application-centric design tools and bolstering the product offering. In horticulture and UV applications the important lighting metric is not flux or total amount of light - we need to be talking about light density. So if we take horticulture as an example, micromoles per second is the unit of flux for the horticulture market. But what is important for the plant is not the total amount of flux; it's the amount of light density that is required. From a tool standpoint, we are able to combine various flux measures, whether it's micromoles per second, milliwatts or lumens, and determine a total flux value by combining different options. With our new design tool you can enter a viewing angle, a distance and the amount of time per day, in order to translate that flux into PPF and DLI and compare it with the different DLI requirements from a variety of plant species, to find out how much light is just enough versus too much versus too little.

We've also created an optical simulation tool which takes the total flux and converts it into a heat map of light density to determine the amount of light that will be enough for each type of crop, and whether to change the amount of light, the number of hours the LED lights are on per day and/or the distance to the plant in order to maximize the yield.

And from a UV standpoint, we're working on a new tool with a similar approach to our horticulture tool but adapted to UV-A, UV-B and UV-C applications. If you consider UV-A, where the primary market is curing and printing, we need to also understand the light density information. So we process the total amount of radiometric flux from milliwatts, and convert that to a light density when entering a viewing angle and distance in the tool where we generate an irradiance heat map. Therefore, what we need to understand is the light density and the time it takes for the material to cure. Using UV-C as an example,

Manufacturer	Part Number and Datasheet	Driver Type	Power Conversion Type	Input Voltage Min (Vac)	Input Voltage Max (Vac)
Invertronics	LUC-010603SDSM	Constant Current	AC/DC	90	305
Invertronics	LUC-010603SSSM	Constant Current	AC/DC	90	305
Invertronics	LUC-012603SDSM	Constant Current	AC/DC	90	305
Invertronics	LUC-012603SSSM	Constant Current	AC/DC	90	305
Invertronics	LUC-012603SDSP	Constant Current	AC/DC	90	305
Invertronics	LUC-012603SSSP	Constant Current	AC/DC	90	305
MEAN WELL	BCD-18-360B	Constant Current	AC/DC	180	295
Philips Lighting	%C8448482432	Constant Current	AC/DC	120	277
Invertronics	LWC-018503SSSP	Constant Current	AC/DC	90	264
Invertronics	LWC-018503SSSE	Constant Current	AC/DC	90	264
MEAN WELL	BLD-26-360	Constant Current	AC/DC	90	296
MEAN WELL	BCD-26-360B	Constant Current	AC/DC	180	295
Invertronics	EUC-025503SDS	Constant Current	AC/DC	90	305

The "Usable Light Calculator" (left) and the Driver Selector" (right) are just two of Future Lighting Solutions' very helpful online tools

determining the amount of light density and the time required to disinfect either a surface area, a volume of water or air, is the objective we are trying to achieve.

**LED professional:** Future Lighting Solutions offers a broad range of design tools already. How important are these tools for the distribution business nowadays?

**Jamie Singerman:** One of the keys to our success has been the development of a number of tools to assist customers in building products that make sense for their market. Our design support services are the accumulation of years of experience, which we make available to our customers. Several of these tools are available online, free of charge. We have thousands of engineers using these tools, saving hours and hours of work to help bring products to market quickly. Many customers don't have a tremendous amount of in-house engineering expertise, and this enables them to "outsource" some of this responsibility to us.

**LED professional:** Which tools are most important right now?

**Jamie Singerman:** The Lighting System Creator (LSC) is our workhorse tool and the most innovative and widely used by engineers. Within a very short period of time, by entering critical system-level parameters, the customer can develop a bill of materials to build a fixture. Customers can specify whether they wish to build using LEDs, Level 2's or modules, then complete the system by selecting compatible optics, thermal management and driver solutions. Within a very short period of time, the customer can create the fixture of their choice.

Our second workhorse is the Driver Selector Tool (DST). With the proliferation of part numbers at the driver level, driver selection can be quite complicated and confusing. We simplify the process by asking the customer to enter certain critical system parameters, and then the tool provides a list of suitable options from which to select.

The Usable Light Tool (ULT) enables customers to understand how much light will be emitted from the LED. This ULT is kept up-to-date by our lighting engineers and currently has

in excess of 15,000 different LEDs characterized, enabling users to fully understand the implications of LED selection on their fixtures. It is, in our opinion, the most comprehensive LED design tool available in the market today.

**LED professional:** Patrick, you are Technical Director at Future Lighting Solutions. How do you update and manage the abundance of data, especially when you think about the continuous product updates that are occurring?

**Patrick Durand:** We collect data by being close to the market and by working in partnership with our suppliers. Many manufacturers supply us with the data sheets to ensure that we are current. There are so many new products being released at the light source level, driver level and optics level to design a luminaire, where it is becoming increasingly difficult for an engineer to keep track of all the innovation. Our strategy is to ensure that our tools are current so that when our customers are leveraging our tools they are working with the most accurate and up-to-date information available.

From a market perspective, FLS currently sees more requests for straight-forward lighting controls solutions than for complete IoT based solutions. Still, they always have an upgrade opportunity in mind. As for most OEMs, there are too many open questions regarding IoT technologies and standards

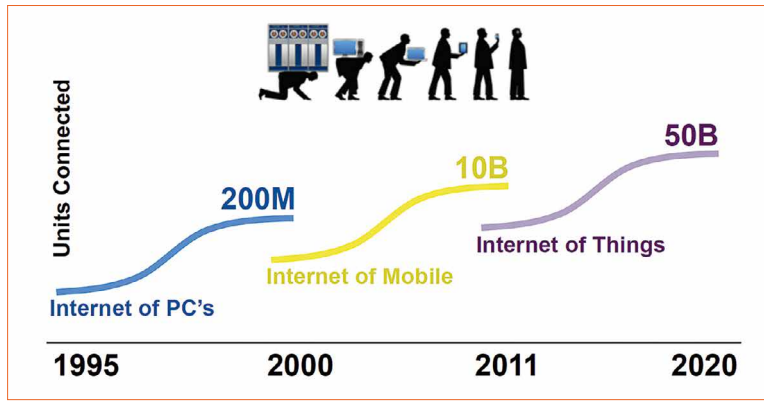

**LED professional:** Besides these tools, Future Lighting Solutions also provides lab support in different countries, don't they?

**Patrick Durand:** We have engineering capabilities and support in the major technical fields, namely in lighting design, as well as mechanical, thermal, optical and circuit design. These resources act as an extension of our customers' R&D organizations. We support them when they need assistance in, which they would otherwise have to outsource to a third party, thus increasing time and cost. Our responsibility from a design support resource standpoint is to make sure our customers can launch products as quickly, efficiently and affordably as possible so that they can remain competitive.

**LED professional:** At LightFair International, where you presented your company and services, we saw a trend going in the direction of Internet of Things and Intelligent Lighting. What do you think about this trend?

**Jamie Singerman:** We've seen significant changes in the business over the past 15 years. IoT and connectivity have been on the tips of people's tongues for a few years. The question is what level of knowledge is in the market - what level of stability in terms of platform adoption is in the market, and what the regional differences are. A year ago it was just a lot of talk and today it is people having to figure out what they need to do and learn. The early adopters will learn from their mistakes and get ahead of the curve.

**Patrick Durand:** We also need to make a distinction between IoT and lighting controls. We must not forget that lighting is a fragmented market. Our customers want something that is simple and that works.

Too often, one hears, "Here's something brand-new, revolutionary, that's going to change everything." However, all the disruptive technology that has been successful to date embraces what is already there, takes a few steps at a time - and then improves upon it. And we cannot ignore how lighting works from a business model standpoint. This is what we are working on to actually resolve. Where we're first starting is with lighting OEMs who want to be pro-active, and implement something so simple that we can do it without having to worry about big data. Our approach from a technology standpoint is about scalability, so customers can start with the basics, and then whether it is six months after the project or two years later, they can add to it as needed, essentially future-proofing the installation.

**LED professional:** These are really quite interesting considerations. What is your opinion in regards to the variety of interfaces and protocols for lighting controls?

**Jamie Singerman:** Because it's so new, many lighting OEMs are saying, "I'm going to wait until the specifier names the exact technology." The issue is, even the dimming signal to the LED driver varies by region; in North America, it's 0 to 10 volts, in Europe it's DALI, and in Japan it is PWM - just for the

dimming signal to the LED driver. Then the control solution will also change depending on whether you're implementing a control solution for a small room or a few rooms in a building versus an entire facility. And finally, it's the building owner or property manager that may have their own personal preferences in terms of what they want to achieve. Another factor is: Is it indoor or outdoor? Is it area lighting or are we doing a full city for street lighting? Like everyone, we are monitoring the evolution so that we can enable customers with their solution of choice.

**LED professional:** What about tunable white light systems and the whole topic of Human Centric Lighting?

**Jamie Singerman:** We're seeing the demand for tunable white light growing, and not just from an interest standpoint, but with customers who need to launch products that have some sort of tunable white. Now the challenge is the control element. How do you actually get it done? Putting cool white or warm white LEDs on a board or a CSP array, or even if there are some new COBs that are going to be launched by a number of vendors that will do it - it's the control element that's important.

We foresee tunable white happening in three phases: Phase One is where we are right now, which is just cool white and warm white LEDs with basically a two-channel driver or something of that nature where you just change the proportion between the two CCTs to generate a desired color point.

Phase Two is cool white, warm white where you add in a third color so you can be on the black bodyline.

Phase Three will be to add in four or more colors to maintain a high CRI value while also maximizing flux and efficacy, so that when you're at one end of the CCT spectrum the lumen value is relatively close to the other end of the CCT spectrum. And with

that comes sensors, because one of the major issues to resolve once multi-color luminaires are installed is, if there is a row of ten fixtures, they all need to look the same. Once we include LEDs of different colors, the LEDs degrade differently, the temperature is different depending on the current, and this is where a closed loop system with optical sensor feedback will be important.

**LED professional:** How do you see the importance of OLEDs for the market?

**Patrick Durand:** We see OLEDs being an eventual adjunct to the LED once the technology matures and pricing decreases to the tipping point, making it a practical light source. We've identified applications that are suitable for OLEDs. There are the obvious ones, such as high-end residential and high-end office, but there are others as well. What do we value about OLED? It's thin and can be flexible. But what's not being discussed enough is the spectral distribution, the quality of the light. With the LED there's a blue spike in the spectrum, but with OLED there isn't that blue spike. From a quality of light standpoint, a 90 CRI OLED will be superior to a conventional 90 CRI LED. If we take a closer look at the value proposition of OLED - interior transportation, like an ambulance or an airplane or a recreational vehicle where space is an issue - that's where OLED can possibly have an impact.

**LED professional:** What makes Future Lighting Solutions unique amongst the big distributors?

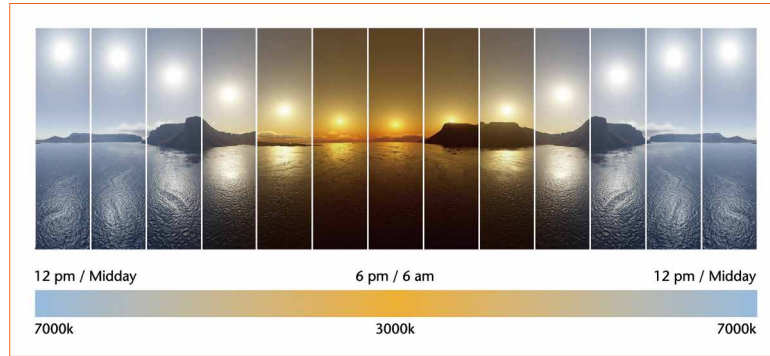

**Jamie Singerman:** We are partners with our customers. We don't see ourselves as a supplier to the customer. We consider our customer as a business partner from a technology perspective, component perspective, and a supply chain perspective. We're very much focused on how we can help the customer with their business model. It's very important for us to be able to add value and fill in the gaps. We make sure they're current in terms of product information, and as Patrick mentioned before, we're always looking forward and working with the customer so that the adopters of new technologies, new applications, can leverage our knowledge to be successful.

**LED professional:** We're coming towards the end of the interview and I wanted to ask if there is anything you would like to share with our readers in terms of strategies, market shares or new opportunities.

**Jamie Singerman:** Our model continues to evolve. The market keeps moving. Our strategy is always to listen to the customer - it's very simple. Understand what they need and deliver to those needs. As we say: "Making LED

Lighting Simple". We'll soon be launching a monthly online newsletter featuring new products. This will go to engineers and buyers - people who need to have timely new product information. You'll be able to click on a button and go directly to a data sheet or order samples. The next step will be to turn that into an app, so they'll be able to access all that new product information directly on their phone or other mobile device. Again, it's all about understanding the market, looking while keeping our pulse on OLED, laser and other technologies, and balancing our resources on what generates business today and for tomorrow. And we're always looking for our suppliers and our customers to tell us anywhere there is a gap in their business model that we can fill.

**LED professional:** Thank you both very much for taking the time for this interview and for being so open with us.

**Jamie Singerman:** Thank you for the opportunity. We really enjoyed talking to you. ■

**Jamie Singerman** expects the tunable white technology development for human centric lighting to evolve in three steps:

1. Using just cool white and warm white LEDs
2. Adding a third (color) LED to better match the black body line
3. Using multiple LEDs of different color to further improve CRI and efficacy over the whole tuning range



## Patrick Durand

Patrick Durand is the Worldwide Technical Director at Future Lighting Solutions (FLS) with 14 years of experience in the solid state lighting industry. Patrick leads the FLS Technical Marketing teams and FLS laboratory teams located in multiple regions around the world with the objective of providing world-class support to lighting OEMs in developing luminaires with the latest SSL technology from the light source to the complete system incorporating the LED driver, optic, thermal management and intelligent control solutions.

Patrick has received a Bachelor of Electrical Engineering from Carleton University as well as a Bachelor of Commerce and an MBA from the University of Ottawa.

# LED-Retrofit Based on AlGaN/GaN-on-Si Field-Effect Transistor Drivers

Efficient driver technologies for LED systems are still a relevant topic. Several new approaches are proposed and new technologies are under development. Andreas Zibold, PhD student at the Fraunhofer Institute for Applied Solid State Physics IAF, and his co-authors, M. Kunzer, R. Reiner, B. Weiß, P. Waltereit, R. Quay, J. Wagner, and O. Ambacher demonstrate the suitability of AlGaN/GaN-on-Si field effect transistors (FETs) for their use in LED drivers. The transistors are tested in an isolated buck converter and an efficiency of 86% is measured for the full converter circuit. The driver circuit is combined with an LED module based on a laser-structured Aluminum Nitride (AlN) ceramic board onto which 21 high power white-emitting LED chips are mounted. This combination resulted in an LED-Retrofit lamp with a total light output of 2676 lm at an efficacy level of 119 lm/W. The results compare favorably to state-of-the-art commercial solutions.

In contrast to conventional light sources that can operate under alternating current (AC), LEDs need a driver circuit to convert the AC line voltage into a constant current. There is a high cost pressure on LED luminaire manufacturers, which also affects the available budget for LED driver solutions. For many lighting applications it is of utmost importance that the driver is small in size, because either only limited space is available in the luminaire, or the design flexibility for innovative lighting solutions can be increased. An ideal LED driver is highly efficient, has low production costs, and yields a small form factor. All these properties can be achieved using wide-bandgap semiconductors, such as Gallium Nitride (GaN) or Silicon Carbide (SiC) in LED drivers instead of Silicon devices. The physical properties of these materials like the breakdown electric field

strength or the electron mobility are superior compared to Silicon (Si) for the use in power electronics [1]. However, conventional Silicon devices are still dominating the market since this technology is highly sophisticated and inexpensive compared to wide bandgap materials. Especially in price sensitive markets, such as solid-state lighting, a competitive cost structure compared to silicon devices is mandatory for a market penetration of such wide-bandgap semiconductors. Especially GaN-on-Si transistors are attractive for LED drivers, since they exhibit low conduction losses and enable high switching frequencies, while they are expected to become cost competitive to Silicon devices in the near future (Figure 1 and Figure 2). It is expected that the cost gap between Si and SiC based devices will remain significant in the foreseeable future.

## GaN-on-Si Transistors

With increasing switching frequencies passive components can be shrunk (Figure 3), which saves costs and leads to more compact solutions.

Thus, GaN-on-Si based drivers may potentially become a low-cost solution with even lower system costs than silicon-based drivers. Furthermore, LED luminaires are long lasting with lifetimes of up to 100,000 hours and therefore the use of short-lived electrolyte capacitors has to be avoided. However, the high capacitances needed for conventional driver designs, can hardly be reached with the long-lasting ceramic capacitors. Thus, the lifetime of the whole lighting system can be increased by the usage of GaN-on-Si transistors in combination with a high switching frequency and ceramic capacitors.

In this study AlGaN/GaN-on-Si HFETs, which are developed, fabricated [2] and characterized [3] at Fraunhofer IAF, are implemented



in fast-switching power converters. A high device performance is achieved as can be seen from their static- and dynamic-parameters in comparison to commercial state-of-the-art silicon power devices. Compared to their Si-based counterparts, the GaN-devices achieve a factor of 3 lower static area specific on-state resistance  $R_{ON} \times A$ , and by a factor of 3 lower static on-state resistance times gate charge product  $R_{ON} \times Q$ .

### LED Retrofit Based on GaN-on-Si Transistors

In order to demonstrate the capability of these power switches for solid-state lighting applications, a compact GaN-based LED driver circuit in an offline-isolated flyback topology has been developed and tested. Utilizing this driver, an LED retrofit lamp with an E27 socket (see Figure 4 and Figure 5) for light bulb replacement is demonstrated and compared to commercially available retrofits.

### GaN-on-Si based LED driver

The driver circuit contains a power factor correction and a normally off cascode. Compared to Si-based counterparts, the GaN-HFET based demonstrator reveals an improved electrical conversion efficiency of 86 %. A maximum output power of 22.4 W is reached. An isolated topology with a transformer is used, as is state-of-the-art for standard Si-based drivers. This provides a high handling security but limits the switching frequency because hysteresis losses, which are proportional to the switching frequency, occur. In this work the switching frequency was set to 85 kHz. An alternative to transformer based isolated topologies are non-isolated topologies, which omit the transformer and the associated hysteresis losses. However, the handling security has to be guaranteed by isolating the electronics from all touchable parts, which may result in an increased packaging effort. Non-isolated GaN based LED drivers are discussed in more detail in [5].

### LED module based on ceramic PCB

The LED module consists of 21 LUXEON TX [6] high power LEDs with specifications shown in Table 1. The LEDs mounted on a laser-structured Aluminum Nitride (AlN) ceramic board with a thermal conductivity in excess of 200 W/mK.

Current	0.35 A	1:00 vorm.
$I_m/W@T_J = 85^\circ C$	141	126.3
Lumens	945.2	2499
CCT in K	4904	4976
CRI	77.1	76.6

Table 1: Optical parameters of the LED module

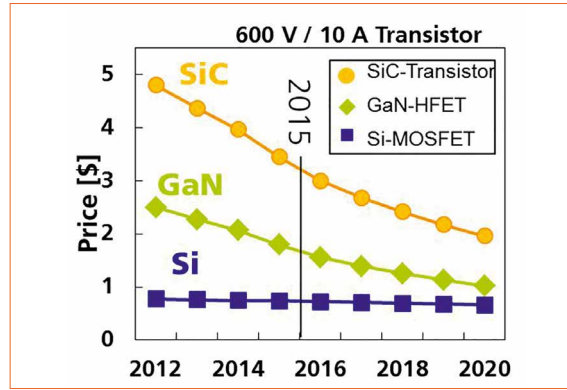

Figure 1: Expected average selling price of a single 600V/10A transistor based on Si, SiC and GaN [4]

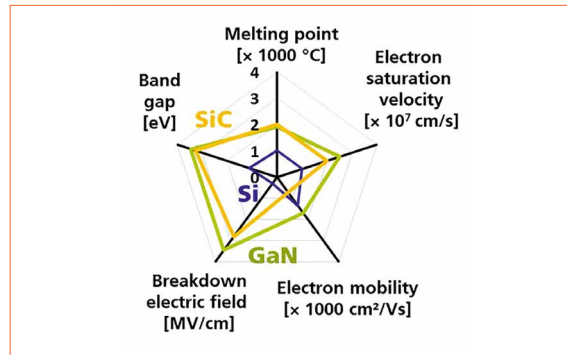

Figure 2: Comparison of several physical properties of Si, SiC and GaN [4]

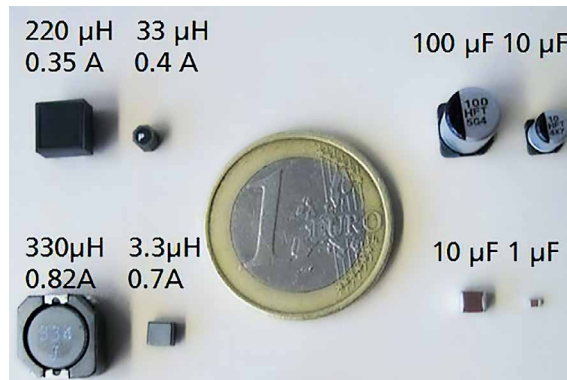

Figure 3: Physical size comparison of inductors and capacitors with different inductivity and capacity

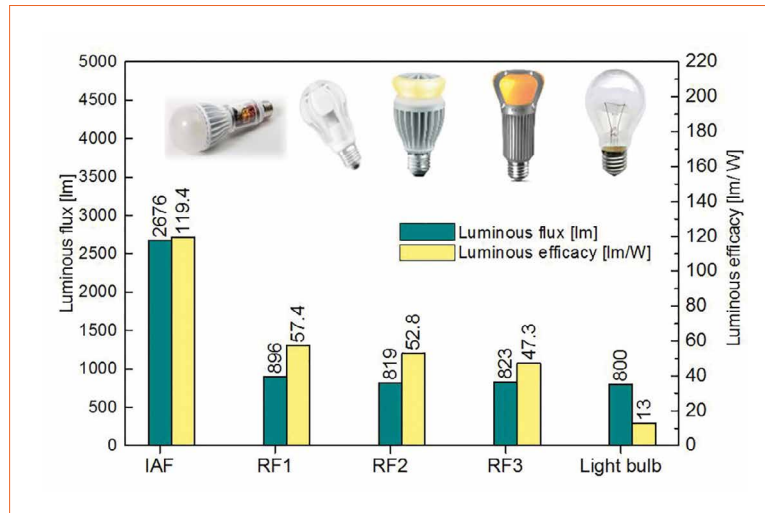

Figure 4: LED lamp in E27 bulb form factor with a power converter based on a GaN HFET in TO-220 package (section containing the power converter extended for demonstration purposes)



Figure 5: LED module with 21 Lumileds LUXEON TX white high-power LED chips mounted on a ceramic circuit board

**Figure 6:** Conversion efficiency and electrical power consumption of the present LED lamp with GaN-based driver (left) and commercial LED lamps from different Retrofit manufacturers (RF) with Si-based driving electronics



Spectral photometry measurements reveal that with the same lamp size a luminous flux of 2676 lm is achieved, which is three times higher than that of commercial retrofits, with an overall luminous efficacy of 119.4 lm/W (Figure 6).

Due to the electrical isolation of ceramic board, the packaging effort can be reduced even with non-isolated topologies. The LEDs were vacuum soldered using Sn62/Pb36/Ag2. The LED module reaches a measured electro-optical

efficiency of 141 lm/W at a current of 350 mA. The Correlated Color Temperature (CCT) of the LEDs is close to 5000 K, i.e. the LEDs are emitting cold white. A Color Rendering Index (CRI) of 77.1 is achieved with the LED module.

### Conclusions and Outlook

GaN-on-Si devices offer excellent properties regarding low switching and conduction losses. Compared to their silicon counterparts the GaN-devices achieve, by a factor of

3, a lower static area specific on-state-resistance  $R_{ON} \times A$ , and by a factor 3 lower static on-state resistance times gate charge product  $R_{ON} \times Q$ . In contrast to SiC, GaN-on-Si is expected to become cost competitive in the near future. Therefore it has the potential to be employed in consumer market applications with high cost pressure. The GaN-technology is still at the beginning of its development and epitaxial growth, design and assembly technology can be further improved. In this work the suitability of GaN-HFETs for LED Retrofit drivers has been demonstrated. GaN based drivers have passed the performance of commercial state-of-the-art silicon devices.

However, to fully raise the potential of GaN transistors the switching frequency has to be increased significantly to shrink the passive component size and cost. Therefore, future work concentrates on techniques to handle switching frequencies in the MHz-range, like spread-spectrum control schemes and non-isolated driver topologies. ■

### Acknowledgement:

The authors would like to sincerely thank all the people at Fraunhofer IAF who were involved in the fabrication of the devices. Furthermore, this work was financially supported by the Ministry of Science, Research and Art Baden-Wuerttemberg (MWK) through the Sustainability Center Freiburg and the "SusLight" project.

### References:

- [1] B.J. Baliga, "Power semiconductor device figure of merit for high-frequency applications", Electron Device Letters, IEEE, Issue Date: Oct. 1989, vol. 10 iss10, pp. 455 – 457.
- [2] P. Waltereit, et al., "GaN-based high voltage transistors for efficient power switching", Phys. Stat. Sol. C 10, No. 5, 831-834, 2013
- [3] R. Reiner, et al., "Benchmarking of Large-Area GaN-on-Si HFET Power Devices for Highly-Efficient, Fast-Switching Converter Applications," in Proc. of CSICS 2013, pp.1-4, Oct. 2013
- [4] Yole Développement SA, "Power GaN: GaN technologies for power electronic applications: Industry and market status & forecasts", pp. 54, 94-97, 2014
- [5] A. Zibold et al., "High Voltage GaN-Based Schottky Diodes in Non-Isolated LED Buck Converters", in Proc. of EPE 2016 ECCE Europe, 5-9th Sep. 2016
- [6] Lumileds, "Extreme efficacy and best performance with compatibility to LUXEON T", 2015 [Online]. Available: <http://www.lumileds.com/uploads/438/DS133-pdf>. [Accessed Nov. 3, 2015]

**NEW CREE® XLAMP® LEDs CAN:**

*IMPROVE RELIABILITY ::*

*REDUCE SYSTEM COST ::*

*REDEFINE LED LIGHTING ::*

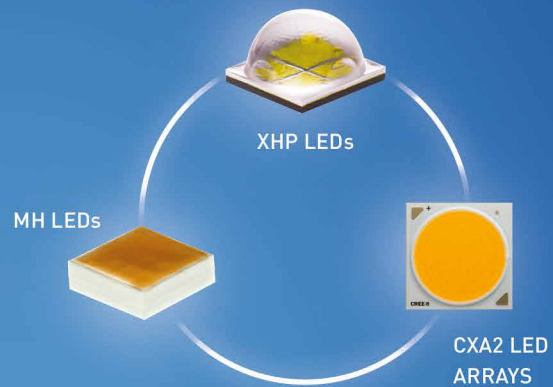

# GAME CHANGING IS GREAT. BOTTOM LINE CHANGING IS BETTER.

You can't change your bottom line by using the same LEDs that everyone else is using. Cree's Extreme High Power (XHP) LEDs deliver double the lumen output at high operating temperatures, while our MH LEDs combine the system advantages of our best arrays with the manufacturing ease of a discrete. And our CXA2 LED arrays are packed with lumens to offer system cost savings up to 60%.

**CREE** 

See how higher power equals lower cost.  
[cree.com/xhp](http://cree.com/xhp)

The new way to a better LED array.  
[cree.com/mh](http://cree.com/mh)

Even more lumens for savings up to 60%.  
[cree.com/cxa2](http://cree.com/cxa2)

# LED Driver Miniaturization - Opening New Opportunities for Solid State Lighting

While LEDs have significantly improved over the past decade, driver technologies have not kept pace and are, in some respects, the limiting factors for new applications. Size is a particular issue. Dramatically increasing the switching frequency helps to reduce size but often causes other issues or is costly. Mickey Madsen, CEO of Nordic Power Converters, explains how his company has overcome the hurdles and made it feasible by designing very high frequency LED drivers.

LED technology has revolutionized the lighting market with efficiency, form factor, lifetime and controllability and continues to offer new solutions. LED drivers have slightly improved and were optimized during the last decade, but the fundamental problems remain: The power conversion technology is basically unchanged since switch mode power supplies were introduced in the 1970's. In terms of size, lifespan and control, the LEDs have outpaced the LED drivers powering them. One way to close this gap is increasing the switching frequency dramatically. The idea is not new, but the possibility to do so in a commercially viable way, is. The applied technology increasing the switching frequency, among others, reduces the size of the passive energy storing components. It thereby reduces size, weight and consequently, the cost of LED drivers while increasing reliability and lifespan.

## LED System Limitations Caused by LED Drivers

The efficacy of LEDs has improved many fold and seen equivalent price erosion over the past decade and are set to continue. The increased efficacy has led to reduced power dissipation and hence, reduced need for cooling. All leading to smaller luminaires with a higher design freedom and reduced cost. The LED drivers needed to supply and control the LEDs have, however, not seen the same great improvements.

First, the size and form factor of LED drivers are set by the needed components such as passive energy storing elements (inductors and capacitors). Secondly, limited lifetime of required components limits the lifetime and reliability of LED drivers, causing them to be a key reason for LED system failures – and often earlier than the users expect. Thirdly, while the cost of LED drivers has decreased with volumes, further cost reductions are limited by raw material for traditional components such as copper. New innovations are hence needed for the LED driver to catch up with the development of LED and to meet the market requirements.

The value, size and price of the passive components in LED drivers scale inversely with the switching frequency, and a dramatic increase in switching frequency will lead to highly increased power density and reduced cost. The benefits of this concept are well known and are equally the problems. As explained below, increased switching frequency results in severe switching losses that ruins the efficiency and cause system failures for hard-switched Switch-Mode Power Supplies (SMPSs).

## Traditional Power Supply Technology

The first switch-mode power supplies were developed in the early 1970's and have since become the market standard for power supplies and LED drivers. The efficiency and power density of power supplies have improved over the 40 years of R&D and since then, have reached better performance as the technology has matured and components have been optimized. However, the improvement pace has reduced vastly.

For power levels of most LED drivers, some of the best results published are efficiencies around

95% and power densities of  $0.88 \text{ W/cm}^3$ . These results are achieved in a laboratory with a controlled environment and without focus on cost. For commercial products, lower efficiency and power density is accepted in order to keep costs down.

Some of the smallest power supplies on the mass market are Apple's well-known sugar cube laptop chargers. The power density of the 60 W version is  $0.59 \text{ W/cm}^3$  (including casing and plug) and the efficiency is 90%. For a USB charger, the efficiency and power density are lower with efficiency around 75% and power density around  $0.31 \text{ W/cm}^3$ . The same trends apply for LED drivers with variances depending on power level, specifications, performance and price. The drop in efficiency and power density at lower power levels is partly due to that casing, plugs, control, start-up, protection and other housekeeping circuitry are independent of the power level, and partly due to a trade-off with price. As the power level increases, the efficiency becomes more important and price increases are generally more acceptable by improved efficiency.

#### Switching losses influences switching frequency

Traditional SMPS topologies like Buck, Boost and Flyback are hard switching, which means the MOSFET semiconductor on the board is switching while there is voltage across it and/or current running through it. The result is that energy is dissipated in the MOSFET every time it turns on. This is known as the switching loss. In traditional converters, the switching frequency is chosen as a trade-off between efficiency (switching losses), size and cost. In most commercial products, a switching frequency in the 50-400 kHz range is chosen as this gives a fair trade-off.

A typical SMPS in this frequency range is shown in Figure 1. Here it is clearly seen that the passive energy



**Figure 1:**  
A traditional power supply where passives constitute most of the volume

storing components, capacitors and magnetics, constitute most of the volume. A breakdown of the Bill of Materials (BOM) will typically result in a 60% and 40% split between the passive and active components, respectively. Hence, significant size and cost advantages can be achieved by reducing the passive components. As the value, size and cost of these components scales inversely with the switching frequency, the direct way to do this, would be to increase the switching frequency significantly into the MHz range, or even into the Very High Frequency (VHF) range (30-300 MHz). A simple increase of the frequency into the VHF range would, however, increase the switching losses almost 1,000 times. This amount of energy would ruin the efficiency and cause overheating and failure of the power supply.

In order to avoid switching losses and become able to increase the frequency while keeping the efficiency high, new topologies have to be used. With resonant converters, zero voltage switching (ZVS) can be achieved, and switching losses due to parasitic switch capacitance can thereby be avoided. Three groups of resonant converters exist: series resonant, parallel resonant and series-parallel resonant converters.

Series resonant converters have the best efficiency and lowest complexity, but have fundamental challenges with output regulation, especially for light and no-load situations.

Parallel resonant converters have better load regulation, but their resonating currents do not scale with the output power. This leads to full load losses even at light loads, causing very low light load efficiencies.

Series-parallel resonant converters have both a series resonant and a parallel resonant element. These elements can be balanced to get the advantages of both the series resonant and the parallel resonant topologies while reducing their drawbacks significantly. The LLC converter is the most commonly used topology for resonant converters. It can be designed with zero voltage switching (ZVS) to reduce switching losses and increase the frequency. LLC converters are often used in step down application from several hundred volts to a few tens of volts and commonly in the power range of 400-4000 W [1].

Since the 1980's, research has been done to use resonant RF amplifiers (inverters) in combination with a rectifier for dc/dc converters [2, 3]. With these types of converters, it is possible to achieve ZVS and/or Zero Current Switching (ZCS). In this case the MOSFET turns on when the voltage and/or current across/through it is zero. Theoretically this should eliminate switching losses, if the switching is done instantaneously and at exactly the right time. In practice, very high efficiencies can be achieved with slight deviations from the ideal case.

**Figure 2:**  
Schematic of a  
class E converter

### VHF Resonant Converters

For the last decade, focus on and research in this type of converters operating in the VHF range has increased. Moving into this frequency range dramatically reduces the need for passive energy storage and cored magnetics. Electrolytic capacitors can be replaced by air-core magnetics and ceramic capacitors, hence minimizing size and price while extending the lifespan [4, 5].

**Figure 3:**  
Schematic of a  
class DE converter

With a switching frequency between 30 and 300 MHz, the main concern when selecting topology is switching losses. The switching loss in a MOSFET due to the parasitic output capacitance increases linearly with the switching frequency and becomes the dominating loss mechanism at these frequencies, if the topology does not take this into account.

### Class E

Most of the topologies are derived from the class E inverter, which utilizes the output capacitance of the switch in the design and insures that the capacitance is fully discharged before the MOSFET is turned on. Some topologies can achieve zero current switching (ZCS) as well. This removes the loss caused by parasitic inductances in, for instance, the package of the MOSFET. Although generally not a big loss mechanism in power converters, this leads the derivative of the voltage to be zero at the switching instance (ZdVS or ZDS) and is hence relevant. It reduces the impact if the MOSFET is not turned on exactly at the right time, as the voltage across it will be close to zero for an amount of time.

The basic class E converter is by far the least complex of the topologies and is well described. Straightforward design processes are available where the individual components do not severely affect each other. The inverter consists of only one MOSFET, two inductors, and a capacitor. It is very well suited for applications with low input

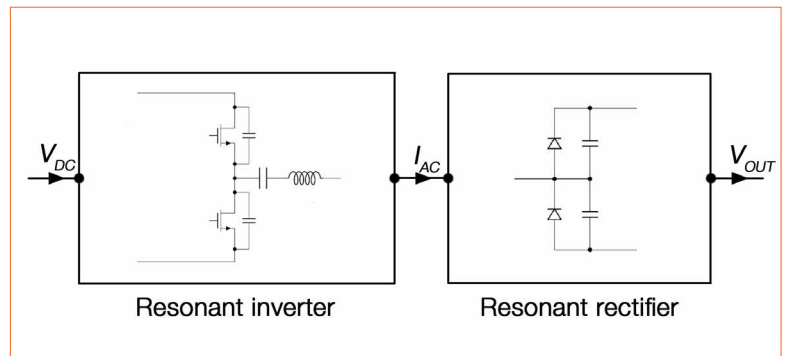
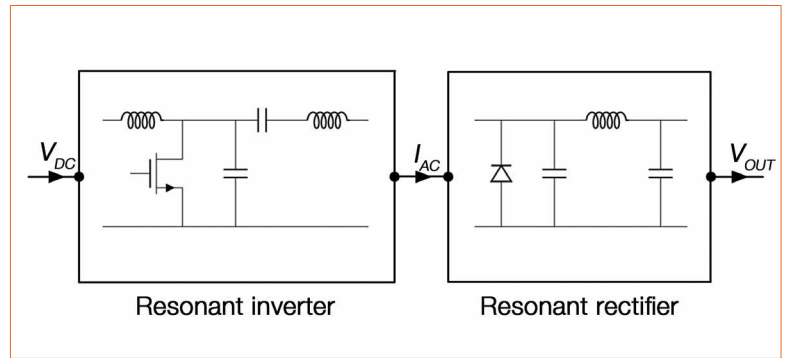

voltage, but for applications with high input voltage (such as mains), a voltage stress of 3.5 times the input voltage across the switch is a major drawback of this topology. If designed to operate in the optimum situation, the inductors are the largest for any of the topologies that limits the transient response and the power density. However, the inverter can be designed to operate in a sub nominal situation with smaller inductors and faster transient response.

The SEPIC converter can be seen as a slightly modified version of a class E converter, the only difference in the schematic is that the inductor in the resonant tank is removed. This does not only reduce the number of inductors, but the two remaining inductors will also be smaller than those seen for the class E (if it is designed to operate close to the optimum). The design of the SEPIC is however more complex, as the inverter and rectifier cannot be designed separately and all components thereby influence each other. Hence better performance in terms of efficiency, transient response, size and cost can be achieved with the SEPIC, but the design is more complex.

### Class $\phi_2$

The class  $\phi_2$  inverter is also a modified version of the class E, the only difference being an added LC circuit, put in to reduce the voltage across the MOSFET by making it more trapezoidal. While this is a good way to reduce the voltage stress, the steep voltage curves require larger currents, making the loss larger than seen for the class E inverter. Though it has 2 extra components, compared to the class E inverter, the physical size can be more or less the same as the inductors are smaller. The total loss is larger than for the class E inverter due to the higher resonant currents. This might be acceptable if it makes it possible to choose from another class of MOSFET, e.g. 100 V devices instead of 150 V devices, but if that is not the case. The class E or SEPIC are better choices.

### Class DE

The class DE inverter is a half bridge inverter composed of the same number of components as the class E inverter; only the largest inductor is replaced by a switch. Hence, this topology only has one inductor, which at the same time is smaller than any of those in the other

topologies. The peak voltage across the MOSFETs is by far the lowest seen in any of the inverters and the currents are also the lowest.

The class  $\phi_2$  inverter was the single switch inverter with the lowest voltage stress. The voltage stress for this topology is approximately 2.5 times the input voltage, which is 2.5 times more than for the DE. This results in more than 6 times more energy stored in the output capacitance of the MOSFET. This is the minimum energy that needs to resonate in order to get ZVS. For low power applications with high input voltages (such as mains connected SELV LED drivers), this therefore sets the amount of resonant currents. Further the class  $\phi_2$  specifically, has even more resonating current due to the 3<sup>rd</sup> harmonic introduced to reduce the peak voltage. Avoiding switching losses and at the same time keeping the resonating currents low, is the key to achieving high efficiencies [6]. The class DE inverter is hence the topology with the fundamental potential to achieve the highest efficiency.

The DE inverter is therefore superior to all the single switch topologies if an efficient high side gate drive can be designed.

### Technical Advantages from VHF

Moving to higher frequencies has several advantages; where the main advantages are miniaturization, reliability/lifetime and dimming efficiency.

#### Miniaturization

Figure 1 illustrates that the passive energy storage elements constitutes most of the volume of an SMPS. As a rough average, these components constitute 95% of the volume and the active components together with resistors etc. the remaining 5%. Although the increase in switching frequency does not reflect one to one the size reduction, increasing the frequency

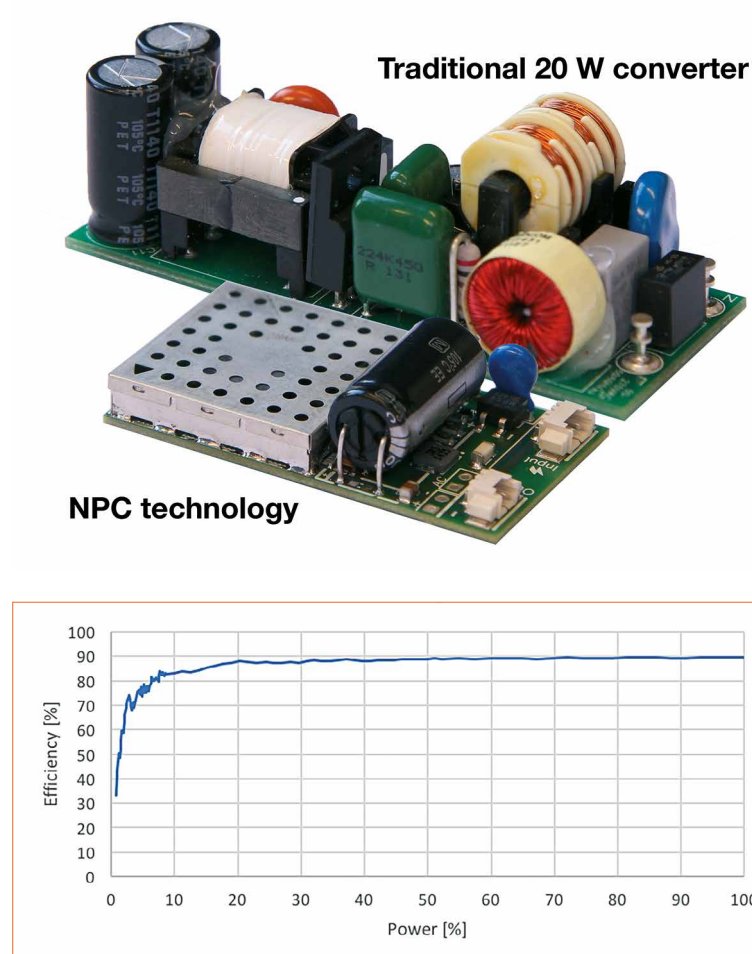

**Figure 4:** Comparison of a 20 W driver with a switching frequency of 100 kHz and 30 MHz

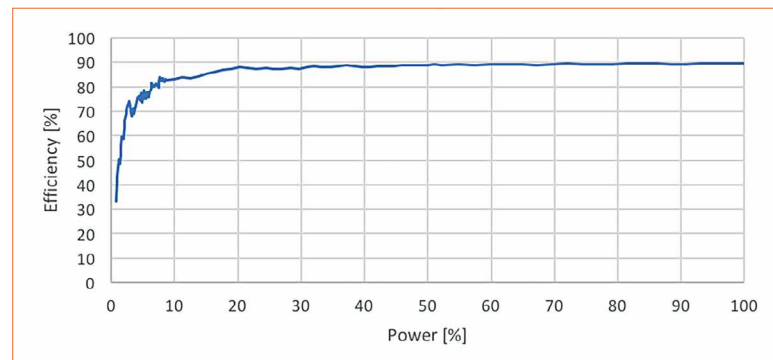

**Figure 5:** Efficiency curve for the 20 W driver operating at 30 MHz

300 times from 100 kHz to 30 MHz will give a reduction of around 10 times. Hence, the overall SMPS will be reduced to approximately 15% of the original volume. This is illustrated in Figure 4 where a traditional 20 W LED driver operating at 100 kHz is compared to a 20 W LED driver operating at 30 MHz.

#### Reliability

A large share of LED system failures is caused by LED drivers; some claim a vast majority. This is, in most cases, due to the electrolytic capacitors as their lifetime is greatly reduced with temperature with the liquid inside them evaporating. The reduced need for capacitance at VHF eliminates (or significantly reduce) the need for electrolytic capacitors and consequently limits this failure cause.

Furthermore, decreased need for energy storage leads air core magnetics to be a feasible

alternative to cored magnetics. The move to air core magnetics requires a significant jump in frequency, as less inductance per volume can be achieved without the core. If the frequency is increased into the VHF range, air core and PCB embedded magnetics become viable solutions, as the inductances needed at these frequencies can be made in a small physical size and the core losses avoided [7]. This does not only reduce the BOM significantly, but also improves the robustness and mechanical stability of the LED driver, as the magnetics components have the highest physical mass and are sensitive to high temperatures.

#### High dimming efficiency

Another strong benefit is increased dimming efficiency. Due to the very high switching frequency, it is possible to modulate the entire converter when dimming, without causing visible flicker. In this way, the converter is either on and

operating under optimal conditions with the highest efficiency or off with will low losses. This enables a very flat efficiency curve. This can either be used to achieve higher dimming efficiency in a specific luminaire or to use a given driver across a wider set of luminaires while achieving high efficiency for all.

Figure 5 shows the dimming efficiency of the pictured 20 W indoor driver operating at 30 MHz.

### VHF LED Drivers

The benefits of VHF power converters push the boundaries of power converters. The trade-offs done for traditional converters are, however, still relevant, as some parameters can still be improved further if the specifications for others are relaxed. The main optimization parameters are generally size, efficiency, reliability, cost and performance. A specific driver design can either use all the advantages of VHF to improve

one or two parameters, or spread the improvement across all parameters as indicated in the spider web in Figure 6.

In this section two examples of VHF LED drivers will be presented. These drivers are both based on the class DE converter and primarily optimized for size (indoor) or reliability (outdoor).

### Compact indoor driver

The 20 W driver shown in Figure 4 is optimized for an indoor luminaire with a slim profile, compact form factor, low cost and high dimming efficiency. The efficiency drops only 5% when dimming down to 10%.

The driver has a general build height of only 6 mm. The electrolytic capacitor is slightly higher, but could be reduced by splitting it into two thinner versions or making a cutout in the PCB. Another option is to replace the electrolytic capacitor with ceramic capacitors as shown in Figure 8. This increases the cost, but extends the lifespan and reduces the height.

### Reliable outdoor driver

The requirements for outdoor lighting are different than for indoor lighting. While size is still relevant, lifespan and reliability are key parameters due to the cost of replacing a failed driver. The 60 W driver in Figure 10 is optimized for this application.

The driver is electrolytic free, which combined with a good electrical and thermal design ensures a lifespan beyond 120,000 hours at 75 degrees TC. Furthermore, it has built-in surge protection of 8 kV / 4 kA common mode and 10 kV / 5kA differential mode, again, to ensure high reliability and long lifespan. The driver is fully programmable and has all standard control interfaces. The driver has a slim profile of only 25 mm and the volume is approximately half of the closest solutions with traditional SMPSs.

Figure 6: Trade-off parameters

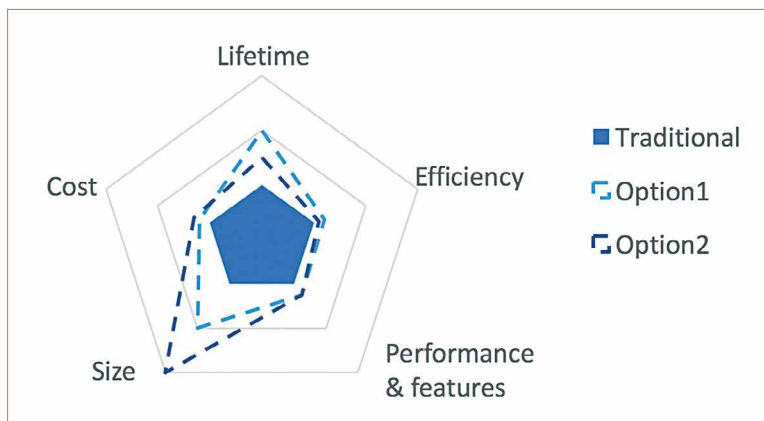

Figure 7: Compact 20 W LED driver without electrolytics

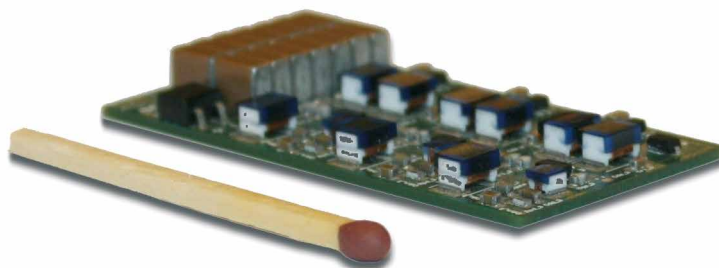

Figure 8: Electrolytic free 60 W LED driver





## Conclusions

LED drivers have become one of the main bottlenecks for LED lighting, both in terms of size and reliability. The technology behind VHF LED drivers provides fundamental advantages for LED lighting with smaller form factor, higher reliability and improved efficiency over the dimming curve. The design of a given driver can be adjusted to

focus on benefits relevant for a given lighting application.

With the progress of traditional power supply solutions stagnating and the requirements for miniaturization due to the improvement of LEDs constantly increasing, new technologies and solutions are needed for the next generations of LED lighting.

By combining circuits from the RF industry with the design methodology of power electronics, it is possible to design new VHF SMPS topologies with effectively no switching losses. Hereby, the need for passive energy storing elements is reduced, enabling removal of heavy and bulky magnetic components and temperature sensitive electrolytic capacitors. ■

## References:

- [1] M.D. Seeman. Gan devices in resonant llc converters: System-level considerations. Power Electronics Magazine, IEEE, 2(1):36–41, March 2015. ISSN 2329-9207. doi: 10.1109/MPEL.2014.2381456.
- [2] J. Rivas. Radio Frequency dc-dc Power Conversion. PhD thesis, Massachusetts Institute of Technology, 2006.
- [3] M. Madsen. Very High Frequency Switch-Mode Power Supplies – Miniaturization of Power Electronics. PhD thesis, Technical University of Denmark, 2015.
- [4] D.J. Perreault, Jingying Hu, J.M. Rivas, Yehui Han, O. Leitermann, R.C.N. Pilawa-Podgurski, A. Sagneri, and C.R. Sullivan. Opportunities and challenges in very high frequency power conversion. In Applied Power Electronics Conference and Exposition, 2009. APEC 2009. Twenty-Fourth Annual IEEE, pages 1–14, Feb 2009. doi: 10.1109/APEC.2009.4802625.
- [5] J.M. Rivas, D. Jackson, O. Leitermann, A.D. Sagneri, Yehui Han, and D.J. Perreault. Design considerations for very high frequency dc-dc converters. In Power Electronics Specialists Conference, 2006. PESC '06. 37th IEEE, pages 1–11, June 2006. doi: 10.1109/PESC.2006.1712114.
- [6] M. Madsen, A. Knott, M. A.E. Andersen. Low Power Very High Frequency Switch-Mode Power Supply with 50 V Input and 5 V Output, IEEE Transactions on Power Electronics, December 2014, vol.29, no.12, pp.6569-6580.
- [7] M. Madsen, A. Knott, M. A.E. Andersen, A. P. Mynster. Printed Circuit Board Embedded Inductors for Very High Frequency Switch-Mode Power Supplies, IEEE Energy Conversion Congress and Exhibition Asia DownUnder, Melbourne, Australia, June 2013. Conference Proceedings p1071-1078.



Visit us at LpS in Bregenz booth A16  
[www.topsilglobal.com](http://www.topsilglobal.com)

# TOPSILGLOBAL

## Excellence in processing of silicone & TPE

Did you know that silicone is the most durable of all optical materials, when it comes to light transmittance stability?

Other advantages of optical silicone are:

- Outstanding heat aging and UV resistance
- Very accurate mould surface replication
- Possibility of combining a lens with a sealing in one part
- and many more...

Topsil Global has more than 25 years of experience in silicone processing

- Long lasting cooperation with world leading lighting companies
- Unique experience in optical silicone processing, since 2012
- Support at every stage of product development

# SoC Technologies in Lighting - Today's Landscape and Tomorrow's Practices

A system-on-chip (SoC) quite suddenly became an important component in the lighting industry, fueling IoT innovation and opening new opportunities, while at the same time bringing disruption and new challenges. With rapid advancements in wireless communication, the impact of connected technologies on the lighting business will only keep increasing. This means deeper integration with SoCs and more attention from silicon vendors as they start competing for market share in this promising segment. But what is the current state of SoC design from the lighting perspective? Are chipmakers keeping up with the growing expectations for wireless lighting control solutions that are mature and truly reliable? When developing its complete Bluetooth software stack for professional lighting, Silvair worked with a number of different SoCs. Therefore, Piotr Winiarczyk, Wireless Solution Architect, and Szymon Rządkosz might have found the answers to these questions.

Since the early 2000s, system-on-chip solutions have had a tremendous impact on embedded and portable technologies. The concept of integrating multiple specialized chips and functions into a single piece of silicon set new standards in computer miniaturization, driving the smartphone revolution and paving the way for new applications. With the advent of the LED era, SoCs entered the lighting component market, promising to revolutionize the analog lighting control industry. This transformation is underway, accompanied by chaos and uncertainty, but there is no doubt that system-on-chip technologies will remain part of the lighting landscape. However, there are still many challenges to overcome. The adoption rate of connected lighting is not particularly impressive and things seem to be stuck at the early adopter phase.

We've been hearing about smart lighting benefits for several years, but technology fragmentation hasn't reduced at all, wireless systems can't match wired solutions in terms of reliability and scalability, and there are still more questions than answers with respect to future business models and industry standards. Are SoCs part of the problem? Let's take a closer look at system-on-chip technologies to find out whether future developments in SoC design can contribute to widespread adoption of connected lighting in commercial spaces.

## SoCs Basic Architecture and Structures

A system-on-chip contains a number of hardware components. At the heart of every SoC is a CPU, which is where information processing takes place. Depending on the type of processor used, different types of SoCs can handle information at different rates. The efficiency of this process is extremely important from the perspective of commercial lighting systems. A mesh topology, which is considered essential for connected lighting applications, imposes high requirements on wireless networking infrastructure. Such networks keep buzzing with activity as hundreds of data packets constantly travel in all directions, relayed between individual nodes and repeated a number of times to prevent packet loss. They are never silent, even when lighting conditions remain unchanged in a given space. This is particularly true for adaptive lighting systems that use sensors to drive efficiencies, while sending various types of data to the cloud. Connected lighting systems simply

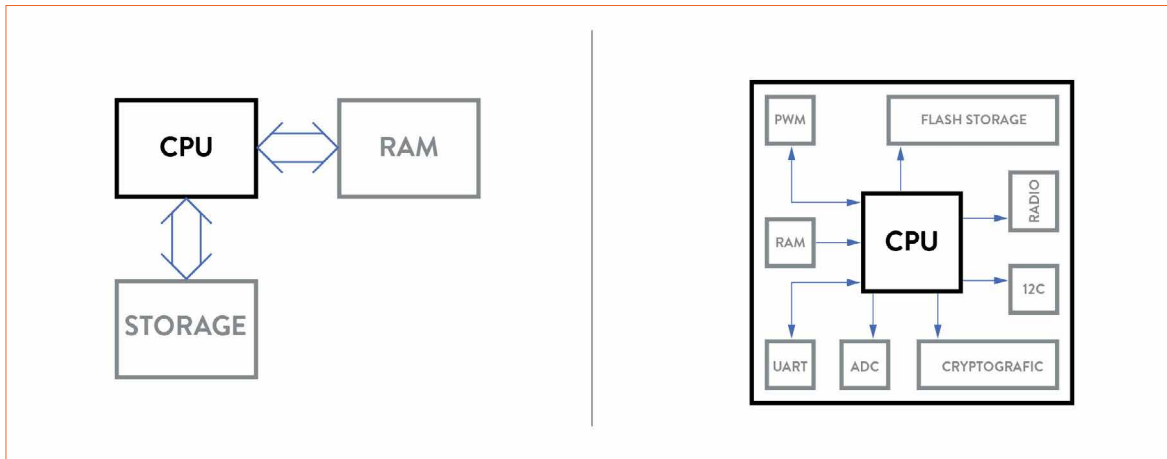

**Figure 1:** A traditional computer architecture can be seen on the left. All major components are separate chips interconnected via data magistrale. A typical SoC architecture is presented on the right. All SoC components are integrated into single chip and connected internally

require SoCs to process significantly more information than typical IoT applications, which is why computing resources are so important.

Information processing capabilities are also strongly correlated with the ease of development. When working with less efficient CPUs, developers need to spend significant amounts of time on code optimization. This results in higher costs and longer time-to-market as programmers struggle to ensure stability of their software stacks instead of developing robust software features. The same applies to another hardware component found in every system-on-chip, the memory block. SoCs with 8kB RAM and 8-bit processors based on architectures designed in the 80s can still be found in chipmakers' portfolios. They do offer stable programming tools but require enormous optimization effort due to limited processing and memory capabilities. More recent system-on-chip solutions, e.g. the ones with at least 64kB RAM and 32-bit processors, provide much more efficiency and design flexibility, while enabling the usage of advanced programming techniques, such as thread isolation. From a developer's perspective, it is incomparably faster, easier and more convenient to build software stacks for such silicons.

In addition to RAM memory, SoCs also include flash memory. This is another critical component for connected lighting applications. Flash memory stores information

that is shared by all of the nodes of a wireless mesh network. This includes sensitive data, such as security keys. It should be an absolute requirement for SoCs used in professional lighting to have built-in flash modules since they are resistant to the so-called "trash can attack", a serious security threat that is very often overlooked. If a discarded device has an SoC with external flash memory, the memory unit can be unsoldered and security keys can be retrieved from it, allowing unauthorized persons to eventually access the network. This cannot be done with SoCs using built-in flash.

Another hardware component found in SoCs is the radio module. In hopes of reaching a broader set of market applications, silicon vendors, more and more often, provide support for more than one radio protocols in their chips. This seems like a reasonable response to technological fragmentation in the wireless communication landscape, although it would be better for everyone if such desperate moves were not necessary. Multiple protocol stacks require more resources and in the world of the IoT - and commercial smart lighting in particular - there is never enough processing power or memory.

SoCs also include a variety of integrated peripherals, sensors and external interfaces - such as UART or PWM. Both are very relevant when it comes to development of

products for connected lighting applications, but are commonly found in today's SoC solutions.

### Evolution of SoCs

If we look at technological advancements in SoC design over the last couple of years, it is difficult to point out specific groundbreaking developments that could be called real enablers of higher integration between systems-on-chip and lighting products. A number of factors were important from the point of view of connected lighting solutions, but it's more about gradual improvement and optimization than revolutionary changes. In which areas this improvement was most significant? Data processing, memory resources and energy efficiency, just to name a few. As was already emphasized, more resources translate to higher stability and robustness, while at the same time allowing for quicker development and shorter time-to-market. But as we delve into more specific features of software stacks used in connected lighting products, it turns out that benefits are much bigger.

Security is a perfect example. The whole problem with security in the IoT is that relevant security mechanism needs to be run on small devices with very limited resources. At the same time, attempts to break these mechanisms can be carried out on powerful computing farms. And smart devices have to withstand such attempts. If we expect to see

**Figure 2:**

In a traditional computer architecture, encryption keys are copied between storage, CPU and memory (left). In an SoC without a cryptographic module, encryption keys are copied between storage, CPU and memory while not leaving the chip (center). In SoCs containing a cryptographic module, encryption keys don't leave a cryptographic module of the chip (right)

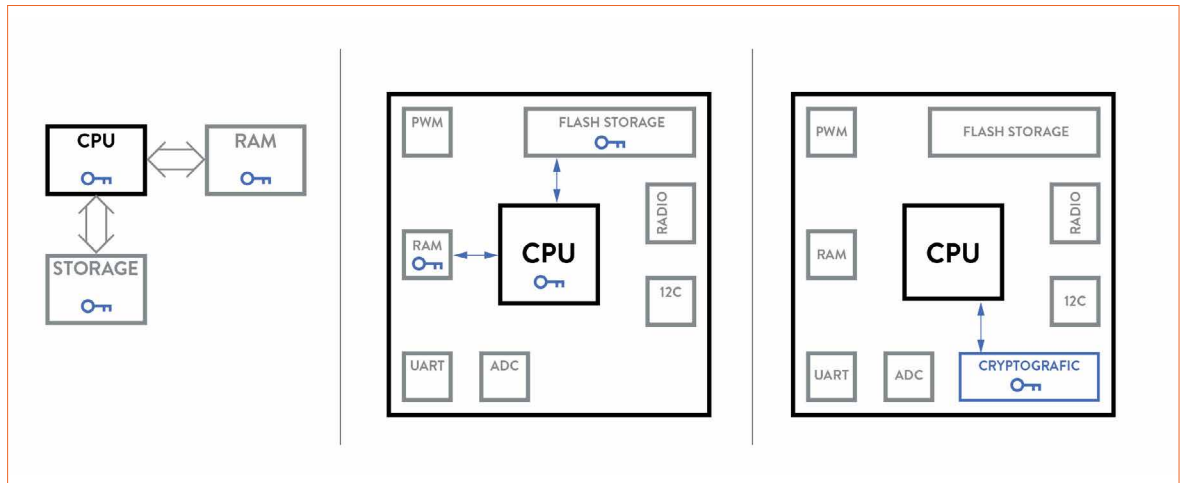

connected lights inside hospitals, airports and schools one day, then security simply must be flawless. In the era of traditional wired lighting control systems, this wasn't even an issue. Security just wasn't needed. But in the world of connected lighting, it's clearly one of the biggest challenges. To meet these stringent requirements, SoCs need to handle advanced encryption and authentication procedures. Strong processors found in the latest generations of chips are capable of handling modern and effective encryption algorithms without a significant trade off in overall SoC performance. To support encryption mechanisms even more efficiently, systems-on-chip often include dedicated hardware security modules.

Chips with more processing power and more memory resources can also handle software stacks with more functionalities implemented in them. This directly translates into more features that smart lighting products can accommodate. Such features might include, e.g. a time scheduler automatically controlling LED fixtures, a system for real time synchronization, support for battery operation, etc. On the other hand, flash memory resources are very important for the over-the-air firmware update capability. SoCs with sufficient flash can carry out this process without interrupting device operation because they can store two copies of firmware. A device can keep using the original

copy while the update is being downloaded and implemented, and then switch to a new version once everything is ready. SoCs with smaller flash resources need to overwrite the original firmware during the over-the-air update process, which makes it impossible to perform such updates over a mesh network. And it needs to be remembered that software stacks for connected lighting are particularly heavy. This again shows that SoCs with more resources are simply more functional and can enable more mature and reliable products.

We mentioned energy efficiency as one of the fields where the biggest progress was made over recent years. For lighting and sensor-based applications, these advancements are priceless. Nodes of a connected lighting network need to be able to process information on a constant basis even though some of them have no fixed power supply, which is why support for efficient battery operation is essential. In addition, even when LED fixtures are turned off, their radios are constantly turned on - so optimization in power consumption helps prevent excessive energy drainage. Over the years, silicon vendors have developed advanced power and resource management mechanisms to maximize energy efficiency and battery life. In the latest chips, peripherals have independent and automated clock and power

management so that they can be powered down when not required for task operation. This allows for keeping power consumption to a minimum.

### SoC's in Smart Lighting Applications

Looking ahead, can we expect any spectacular developments in SoC design that could open new opportunities for developers of smart lighting products? A trend we can expect to start witnessing soon is the introduction of cryptographic modules that can radically improve security in connected devices. In addition to accelerating encryption operations, they will act as highly secure storages for network keys. Such cryptocells can carry out all necessary encryption procedures, and keys created as part of these procedures will never leak outside - they won't be circulating inside the SoC itself even though the chip will be able to use them to perform encryption operations. On the processor side, dual-core CPUs are used more and more often these days in modern SoC designs. The trend is likely to continue, increasing processing capabilities of silicon chips.

But apart from that, we should not expect any hardware revolution in SoC technologies over the next couple of years. What we can expect are relatively small, incremental improvements. CPUs will be getting slightly faster,

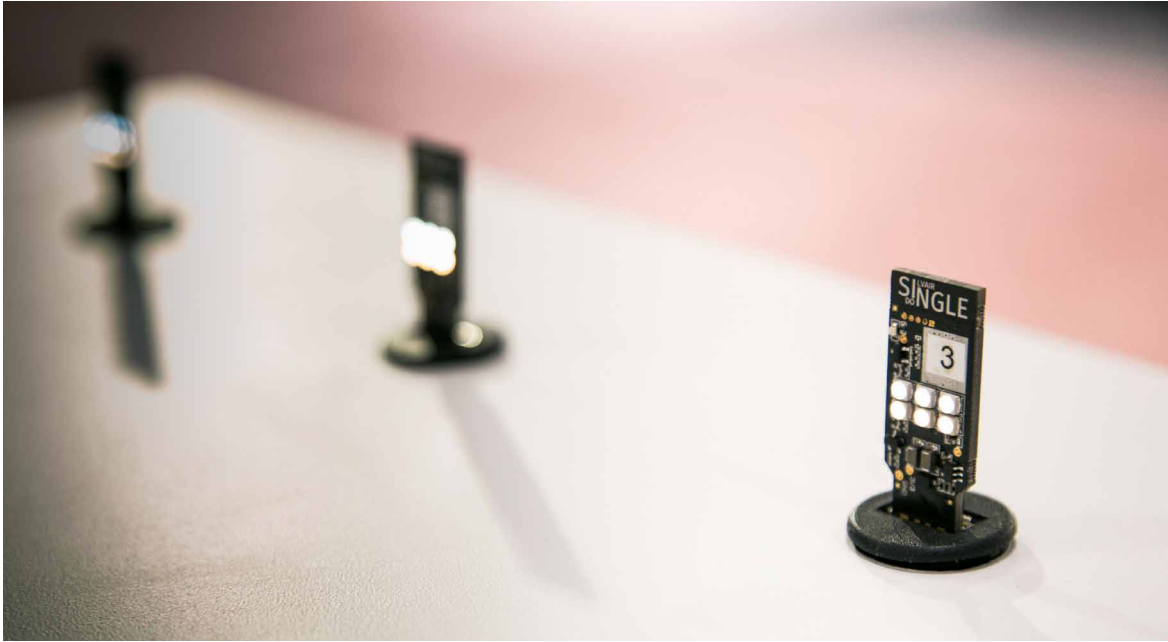

**Figure 3:**  
Tiny Silvair Bluetooth  
Mesh evaluation nodes  
using advanced SoC  
technologies

memory resources will be growing and power consumption will continue to decrease, enabling even longer battery-life in sensor-based applications. All these improvements are certainly welcome, but this is not what will drive widespread adoption of connected lighting in commercial spaces. There are SoCs on the market that can handle even the most demanding software stacks. Silicon technologies are already mature and advanced, and today they give us all the tools we need to build smart lighting networks with wire-like reliability and multiple powerful features. What we still lack is a fully scalable and globally interoperable low-power wireless communication technology. This is where the real revolution is yet to happen, and this is the area that should be watched very carefully right now.

### The Future of SoCs in Lighting

This year looks particularly interesting as far as connectivity technologies are concerned. The Thread Group recently announced availability of the first line of certified software stacks and finally launched its product certification program. We should soon be able to verify how well this new protocol performs in connected lighting applications.

Chances also are that by the time this article is published, the Bluetooth SIG will have released the long-awaited Bluetooth Mesh specification. Contrary to the application layer agnostic Thread technology, Bluetooth covers all of the layers of the OSI communication model and thus seems well positioned to address the problem of interoperability, arguably the biggest roadblock to widespread adoption of smart lighting. With the arrival of new technologies designed to meet the most recent market trends and customer expectations, we are also likely to see legacy protocols fade away. The upcoming months certainly look very interesting as we might finally see some sort of consolidation among wireless connectivity solutions used in connected lighting.

Whether or not 2017 will be a breakthrough year for low-power wireless communication, smart lighting technologies will be getting more mature and more reliable over time. Eventually, the business will grow to a point where silicon vendors will have reasons to start competing more fiercely for customers in the lighting segment. This is when we might see the first line of SoCs dedicated to connected lighting applications. Again, we should not expect this to spark any revolution, as SoC-for-

lighting designs will most likely be focused on further optimization. Crucial components (such as flash memory resources) might be enhanced, while redundant ones (such as interfaces for multimedia or display) might be removed. Developing will get even easier and costs will drop further, although core technologies will be pretty much the same as in today's high-end SoC solutions.

### Conclusions

On a final note, when speaking of hardware for connected lighting, we should not forget about the crucial role of software. As much as we need SoCs to handle complex software stacks required to build professional smart lighting systems, it is the software that defines what these systems will do and how we'll be using them. Systems-on-chip become another specialized component that is needed to introduce new features and functionalities, but they are just the means we utilize to accomplish these goals. At companies, individuals responsible for key decisions regarding SoC design implementation usually have much more to do with software than hardware. And as time goes by, it is the silicon that adjusts to software needs, not the other way around. ■

# Avoiding Brightness and Color Mismatch with Proper RGB Gamut Calibration

For well over a decade, proponents of Solid-State Lighting (SSL) have been offering bullish forecasts concerning the adoption of LEDs for general and specialized lighting applications. Recent years have seen those rosy predictions come true, with LED lighting now almost completely dominating the market for new construction, retrofit, and many replacement lighting applications. For many of these applications accurate color calibration is required. Rood Bouten, CTO at Admesy, explains the reasons and how to perform a proper RGB gamut calibration.

The pace of adoption has surprised even industry insiders. In 2016, the U.S. National Academies of Sciences, Engineering, and Medicine described the “rapid adoption and the accompanying diversity of applications of SSL” as surprising. A 2015 Danish Energy Agency report on European LED Market Evolution noted, “The LED market has started to become a mass market,” driven by a “10 year acceleration in affordability of LED lamps”. This rapid adoption promises significant energy savings and also holds out hope for new applications of light with color tunability, for example, creating new options for the innovative use of light in aesthetic, commercial, and health-related areas.

**Figure 1:** Color tunability is essential for many applications driving the adoption of LEDs

## A New Way of Lighting

LEDs offer unprecedented control over various lighting characteristics such as distribution, timing, and, perhaps most importantly, color. But control over LED color does not necessarily guarantee the precision and quality of LED color. Validating the spectral performance of LEDs is a necessary step in maintaining color performance.

Color calibration is essential for many current applications of LED lighting, and may be even more important in the future. An accurate, traceable spectrometer is a vital part of a color calibration process. Color calibration is a straightforward undertaking, given the proper

spectrometer. Once calibration is complete, users can have confidence that LEDs are providing exactly the right color when and where it is needed.

## The Success of LEDs

LED developers continue to innovate, offering new capabilities - and new flexibility - in the use of light. Much of the flexibility of LED illumination stems from the small size of the light-emitting diodes themselves. That small size allows LED lighting products to be integrated and used in almost any shape. Additionally, RGB LEDs bring possibilities for multi-color tunability to the LED lighting designer.

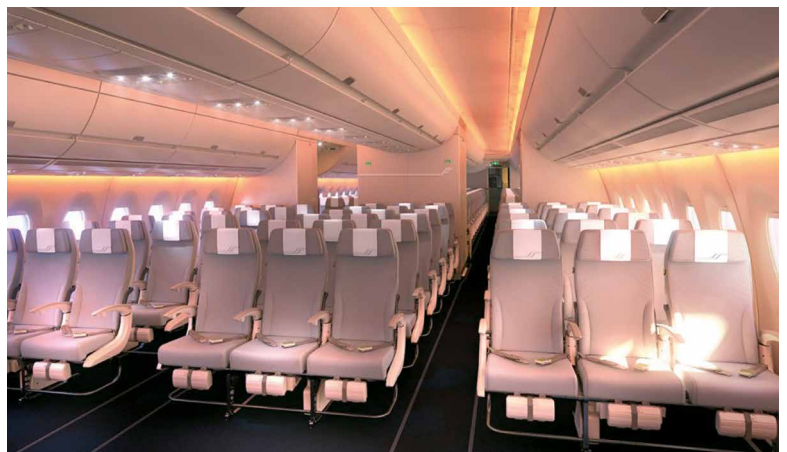

Human centric lighting (HCL) is one force driving new applications. HCL is the blanket term for lighting whose intensity and color are adjusted to optimize human productivity, mood, or health. Examples of multi-colored LED applications can be found in airplanes, automotive interiors, workplaces, and residential mood lights. The character of lighting influences many aspects of the human experience. Changes in light levels and colors can create relaxing atmospheres, as, for example, in airplanes during long haul flights or domestic journeys. Lighting can also increase the level of concentration among students in schools or staff in work environments. Changes in LED illumination can even provide information about a current state, indicating changes in the use of a space or signaling the need for scheduled actions.

Tunable LED lighting also enhances the ability to define, market, and reinforce brand identity. Color is a key feature of marketing campaigns, and color matching is critical for enhancing customer recognition of specific brands. Tunable LEDs are perfectly suited to create the color environment that supports marketing messages.

Multi-colored LED lighting applications are poised to become increasingly important, but their promise comes with a unique set of challenges. White point and RGB Gamut calibration are the tools necessary to meet those challenges.

### New Capabilities Create New Problems

RGB LEDs can create just about any visual color, but creating the right color is a major challenge. And once the correct color is defined, it remains a challenge to maintain color and intensity consistency across all the LEDs in a specific implementation. Some tasks, for example, depend on a specific color temperature of white light, and brand identities are built on color

consistency. So the exact tunability of RGB LEDs at a specific color is of high importance. Additionally, when multiple RGB LEDs are used to create this determined color over a large area, color consistency between LEDs has to be guaranteed as the human eye can detect subtle differences in color or brightness. The eye is especially sensitive to differences in color or brightness among individual LEDs located near each other.



**Figure 2: Even subtle color differences are detectable by the human eye. Lighting system designers must address this issue when using color tunable LEDs**

Visible differences in color or brightness create an impression of lower levels of quality. For that reason, color and brightness consistency within luminaires is of high importance for LED lighting product manufacturers.

### The Source of the Problem

One of the causes of color difference is related to the production process of LEDs. LEDs are mass-produced and minimal variations in material structure, composition, or thickness will lead to slight differences in color and brightness. LEDs are binned - basically a sorting process - to keep variations of color and brightness of a particular group of LEDs within defined acceptance criteria. The level of binning is defined by the value of the accepted tolerances for color and brightness. Although small tolerances lead to tighter binning and more uniform LED color, they also influence the price of LED lighting products: Small LED bins result in higher prices.

Another cause of color difference relates to the processes of driving and dimming LEDs. The relation between forward voltage and

forward current is non-linear. In addition, the relationship between forward current and brightness - light output - of an LED is also not linear, which introduces more complexity. Minor changes in forward voltage can then directly affect the LED's brightness and color point.

Often, Pulse Width Modulation (PWM) is applied to control RGB LEDs, which enhances the stability of driving and dimming LEDs. One of the advantages of driving LEDs with high frequency pulses is to enhance their lifetime. A reduced duty cycle lowers the average junction temperature. High junction temperatures can directly result in a shift in peak wavelength, thus color, and lowers the expected LED lifetime.

### Calibration is the Key

Two methods work to overcome the problems in color consistency both among individual LED packages and in large scale luminaires.

These methods are:

- White point calibration
- Gamut calibration

#### White point calibration:

Calibrating the white point of a light source is basically moving the color point of a sample towards a target color point, as shown in Figure 3. The first step in changing the color point to the right value is to precisely measure both the sample and target CIE xyY color coordinates. A spectrometer can measure and determine the XYZ values, which can then be used to determine the CIE xyY coordinates.

Once the color coordinates are known for both the sample and target light source, the calibration can be carried out. By changing the brightness of each individual LED (Red, Green and Blue) of the luminaire, the color point of the sample light source can be changed until it matches the target light source, as illustrated in Figure 4.

**Figure 3:**  
Sample white point and target white point

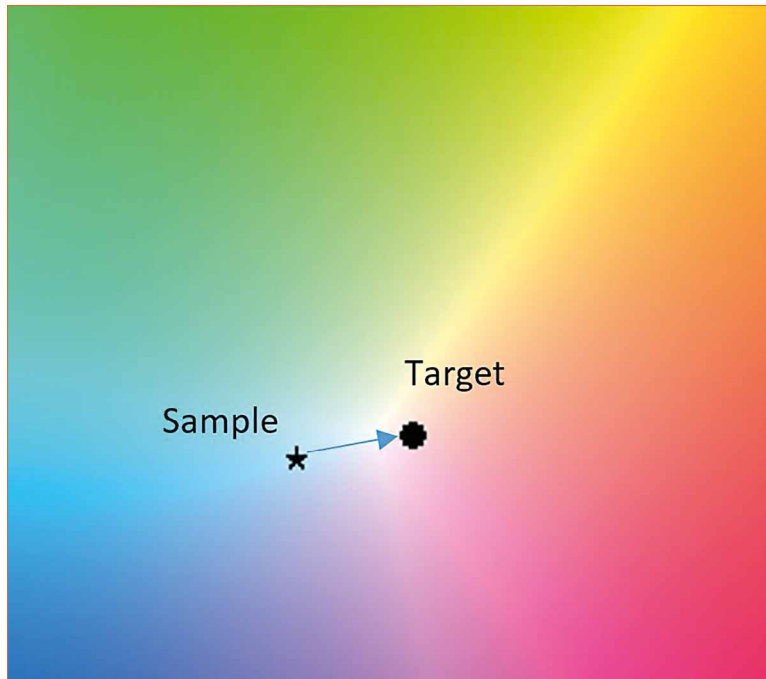

This calibration process provides a compensation factor for each individual LED inside the RGB LED.

The white point calibration process provides a compensation factor for each individual LED inside the RGB LED.

$$R_{new} = A * R_{ori}$$

$$G_{new} = B * G_{ori}$$

$$B_{new} = C * B_{ori}$$

Calibrating the individual LEDs can be done at different levels:

- Adjusting the current through the LED
- Adjusting the pulse width of the PWM signal
- Adjusting RGB values of the input to new RGB values

**Figure 4:**  
Sample and target light source before calibration (top) and after calibration (bottom)

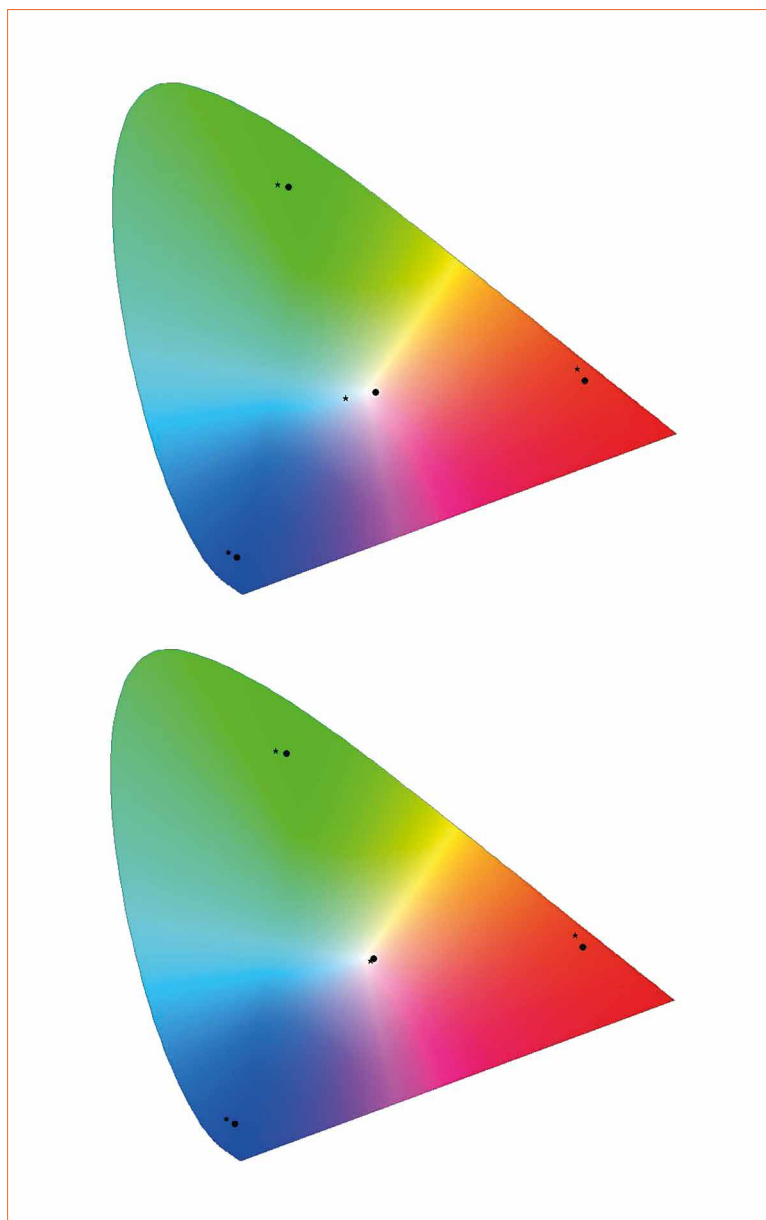

This method is a relatively straightforward way of balancing the colors between two different luminaires. This is a simple method of determining the compensation factors, especially when choosing the correct RGB bins to ensure the primary colors match. A disadvantage, however, is when applying this method to RGB LEDs from different bins. In that case, even with an identical white point the saturated colors can appear different.

The light output curves for RGB LEDs from different bins vary with higher and lower current. The white point calibration for these LEDs provides a set of drive currents for each LED - the currents at which the LED will output white light of the desired color temperature. When operated away from the calibrated white point, however, the different output response of the individual LEDs from different bins will lead to variations in output color. For this specific reason, it is recommended to select LEDs from the same bin to keep color differences of saturated colors within limits.

But selecting LEDs from the same bin isn't the only way to match color appearance. Calibrating the color



gamut is a powerful technique to match color appearance regardless of the source of the LEDs.

### Color Gamut Calibration

The gamut of an RGB LED light source is defined as a triangle within the color space. The shape of the triangle as shown in figure 5, the gamut, depends on the color points of each individual LED.

Gamut calibration is fundamentally similar to the process of white point adjustment, but now applied to each individual red, green, and blue LED. The color coordinates of each saturated LED may be different than the individual LEDs of the target light source, but the net color characteristics can still be matched. By adding small amounts of green and blue to red, for example, the red of the sample can be calibrated towards the target. The same holds for calibrating the green and blue

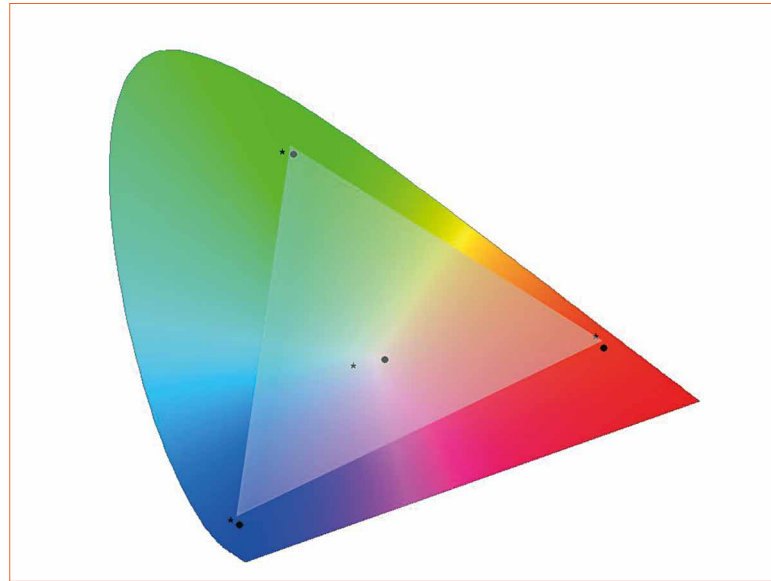

**Figure 5:**  
Gamut of the target light source:  
The triangle defined with vertices at points corresponding to each of the R, G, and B LEDs

color points. The final result is an exact overlap of the gamut of the sample and target light source. With reference to Figure 5, a perfect color gamut match means the 'triangles' of both the target and sample light sources perfectly match one another.

As with white point calibration, the method for gamut calibration is straightforward:

- Calibrate the white point
- Measure and apply matrix [M] based on RGB color input values and RGB color target values



# LONG GLASS TING

### LED optics made from glass. The intelligent choice.

LED technology is more efficient today than ever before. So why use yesterday's materials? Rely on the advantages of our optics made from glass: temperature and UV resistance, stability and a long service life. In addition to proven standard products, we develop customer-specific and precise solutions: for your groundbreaking lighting concepts. And for light that stands the test of time.

See for yourself – **at LED professional Symposium+Expo 2017, Bregenz, Stand A21!**  
Visit also our stand - **at ISAL 2017, Darmstadt, 26-27 September 2017.**

[www.auer-lighting.com](http://www.auer-lighting.com)



The first step is the same white point calibration as explained previously. Carrying out the white point calibration in advance will set the sample luminaire to a good default state. The second step is calibrating each red, green and blue LED towards the desired RGB primaries of the target source. This results in XYZ values for each target primary and each sample primary color. These XYZ values are the input for creating the [M] matrix, which is used to (re) calculate the input RGB values to the right RGB output values.

This is how the matrix is created:

- Define XYZ values of target primary colors
- Measure XYZ values of sample colors
- Calculate 3 x 3 matrix [M]

A major advantage of gamut calibration is that two RGB luminaires can be matched. Because the color coordinates of each primary LED are measured, it's relatively simple to create a matching gamut. One disadvantage, however, lies in the practical difficulty of achieving the desired result.

The difficulty of color calibration is increased by factors such as the gamma curve, which represents the nonlinearity of light output as a function of forward current. Dimming to low luminance or low individual RGB values also introduces complexity. For such reasons, we recommend starting with white point calibration only. Combined with good LED binning, one can expect good results in color matching and consistency between luminaires.

$$RGB_{output} = [M] * RGB_{input}$$

**Figure 6:** Gamut defined by three white dots, which all lie within the sample and target. Color gamut calibration improves the spectral accuracy of the light output, but with a corresponding slight reduction in the extent of the color gamut

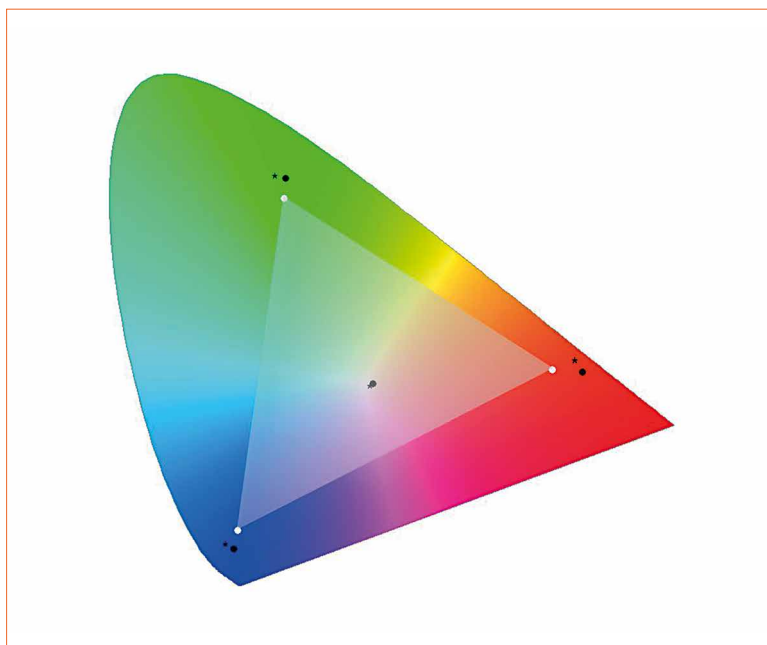

**Figure 7:** A spectrometer disperses incident light into its constituent wavelengths. Performance is determined by the quality of the dispersive elements, the optics and detector, and the overall system design

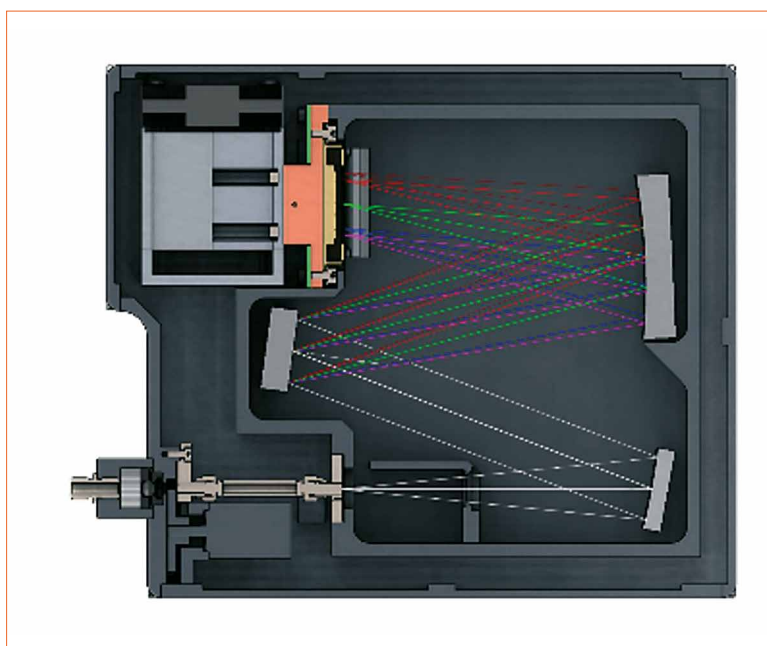

### Making Calibration Possible

The preferred device for carrying out white point and gamut calibration is a spectrometer. A typical spectrometer is a device that uses a grating to disperse light into individual wavelengths. The proportions of each wavelength can be quantified by an electronic detector, making it possible to accurately measure color and brightness.

Theoretically a tri-stimulus colorimeter could be used to approximate these spectral measurements, but the variations across LED bins are too big for a colorimeter to measure them accurately. That's why a spectrometer is the tool of choice. Spectrometers used for precise measurements should be accurate and have high resolution, and should also be calibrated correctly. Non-calibrated or poorly calibrated spectrometers could lead to inaccurate measurements and, consequently, incorrect color calibrations of luminaires. Besides, when using multiple spectrometers for white point or gamut calibration, the results might be completely different. Individual NIST-traceable spectrometers can still vary from one another, as a NIST calibration only calibrates spectral readings for the single condition of measuring a specific NIST traceable lamp. In such cases it is impossible to determine which system is good and which one isn't.

A spectrometer used for calibration should have:

- Wavelength accuracy
- Low non-linearity
- Traceable absolute calibration
- Dark current compensation
- Excellent stray light performance

Note that absolute calibration is very important to ensure the spectral data of a light source is exactly the same for each spectrometer. Consider the term “traceability” carefully as it can sometimes be used rather casually, and does not always mean the device is at a good traceability level.

### Conclusions - The Value of Spectral Calibration

LED lighting offers unprecedented control over various aspects of the illumination environment, including color. But control, in and of itself, does not imply accuracy. Poor control of color and brightness can produce an unpleasant or undesirable lighting environment or display appearance. The proper use of a high-quality spectrometer can make that problem disappear.

A spectrometer can be used to generate white point and color gamut calibration. Applying those

calibrations to RGB LED light sources to match colors of different luminaires can enhance the user experience of lighting products. Considering this step during the production process or during installation can solve the potential problems of color and brightness mismatch. The result is a lighting environment that takes advantage of LED characteristics to produce lighting environments that enhance the user experience. ■

#### References:

[1] <http://inhabitat.com/this-super-efficient-new-airplane-eliminates-jet-lag/>



DRIVE IN A NEW LIGHT

SMART LED CONTROLLER FOR AUTOMOTIVE

## REVOLUTIONARY LED-CONCEPT FOR INTERIOR LIGHTING IN VEHICLES

Smart LED – the new dimension of light in video speed  
Designed for Automotive.

► [www.inova-semiconductors.de/iseled.html](http://www.inova-semiconductors.de/iseled.html)



**inova**  
Semiconductors  
**SPEED UP YOUR DATA.**

# Interior Automotive Lighting Control Redefined

In modern car's interior lighting, tough requirements and rising complexity are a huge challenge. A new industry consortium was formed to meet this technological challenge and to provide a comprehensive ecosystem for the new digital LED lighting paradigm. The founding members of the Open ISELED Alliance are Inova Semiconductors (ISELED "Digital LED" concept and LED controller), Dominant Opto Technologies (LED manufacturing and packaging), NXP (system microcontroller), TE Connectivity (system integration and connection technology) and Pforzheim University (theoretical framework). The alliance recently added LucieLabs (software, firmware), a French IoT Software startup to its line-up. The goal of all these organizations is to work in close cooperation to present a complete system solution - a true ecosystem. Roland Neumann, CTO of Inova Semiconductors introduces the challenges and the worked out innovative solution that uses a single system controller to individually address up to 4,096 LEDs.

Were an engineer from a century ago to examine today's motor vehicle, its basic aspects would certainly be quite recognizable. It is a fact that the car concept has remained essentially unchanged since the early days of the automotive industry - a chassis, four wheels, doors, windows, engine and steering wheel.

Beyond these basic characteristics, however, cars have incrementally been subject to a fundamental transformation. Today's level of comfort and safety is in a completely different universe when compared to vehicles from just a few decades ago,

even in the lower-price market segments.

With strict industry-wide norms applying practically across the entire automotive sector, differentiation is becoming increasingly challenging for the car manufacturer, though not for lack of trying. One area where carmakers are recognizing fresh opportunities to stand out from their competitors is 'LED interior lighting' - an increasingly important selling point. Design engineers are seeking to create a unique in-car lighting experience that will make their brand and corporate marketing overshadow their competition. A new vehicle

outfitted with advanced lighting technology irresistibly draws the driver in and emotionally connects with a new world of luxury and exhilaration.

In recent years, LED-based technologies have become an accepted, and increasingly, an expected standard for high-end premium in-car lighting. Nevertheless, there exist significant limitations to the way LEDs are controlled, which has thus far hindered their extensive implementation throughout the car interior. As it stands, current state-of-the-art 'ambient light' technology typically consists of a multicolor LED feeding into an optical fiber (Figure 1).

**Figure 1:**  
Today's automotive interior fiber optic color lighting technology

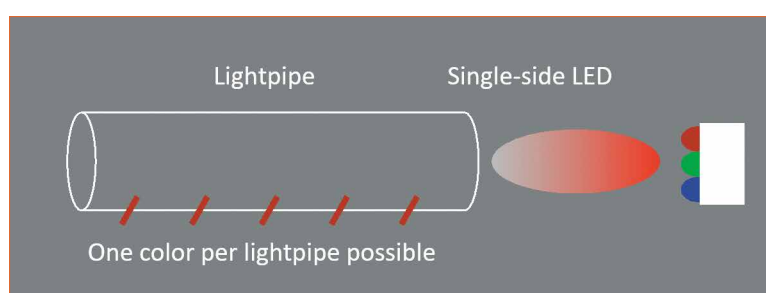

### Today's Challenge - Rising Complexity

The flexibility and visual impact of this existing technology is severely hampered by the fact that the brightness and color outputs of these LEDs can, as a rule, only be configured "in bulk" or in relatively large groups, thus resulting in an often lackluster experience. The standard solution utilizes a central controller to manage the LEDs via a Local Interconnect Network (LIN), a serial network protocol popular in many automotive applications for its lower-cost compared to a Controller Area Network (CAN) bus system.

It is then only logical to mount 10 to 30 RGB LEDs on a flexible light strip that then light up the strip with individual color and brightness (Figure 2). Unfortunately, the carmaker is then faced with some major issues since wavelength and brightness are subject to manufacturing tolerances, temperature degradation and aging, thus the individual LEDs do not consistently emit the same light and color over the vehicle's relatively long expected lifetime, even with identical PWM-signal controls.

This "ageing effect" manifests itself in falling brightness levels due to falling efficiency, which is strongly influenced by the temperature of the LEDs, specifically high temperatures and duration of exposure to them. Another important factor is that temperatures vary significantly throughout the car's interior with temperatures exhibiting noticeable divergence even along a single LED strip in certain cases. A further challenge faced by the engineer is the significant divergence of temperature behavior characteristics of green and blue LEDs relative to that of red LEDs.

Taking these factors into account, car manufacturers continue to demand additional LED functionality for further innovative features and improved daytime LED visibility. In 2010, a typical high-end vehicle might have typically been fitted with fewer than 50 LEDs, however,

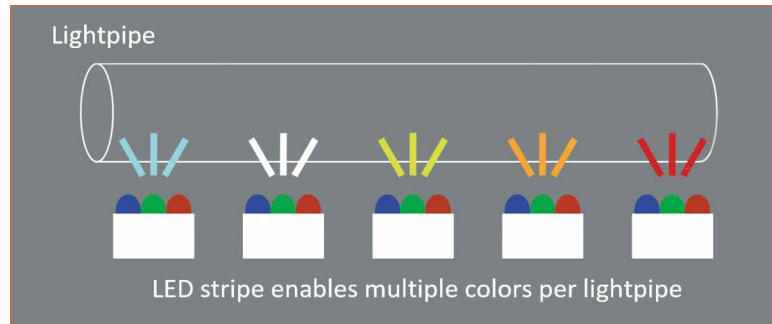

Figure 2: Color LED strip with individual color control

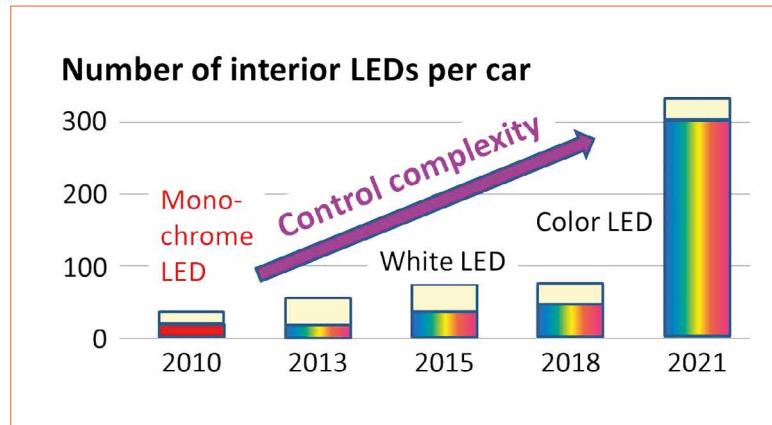

Figure 3: LED counts in car interior lighting are rising steeply (Source: BMW)

by 2021 this number is projected to exceed 300 (Figure 3).

This increase is most predominant in RGB type LEDs, where the three LEDs - red, green and blue - are encapsulated in a single package. This subsequently necessitates a controller to define individual colors, which adds an additional troublesome layer of complexity, thus morphing into a significantly more complex system than was the case with the white and monochrome LED solutions that were so ubiquitous in the market only a few years ago.

### Requirements for In-Car LED Control and Problem Definition

Considering the long list of challenges faced by these present-day solutions and their workarounds, carmakers are in need of a sophisticated yet simple LED control platform that is financially viable, highly controllable and inherently reliable. To achieve these aims, each RGB LED on the color strip must be individually controllable in terms of brightness and color, and, importantly, it must enable calibration. A typical case would be cross-fading of adjacent LEDs from one color into another

with no noticeable brightness and color differences. The ability to compensate for the effects of temperature and the non-uniform ageing of the LEDs is another crucial element. The system should provide for straightforward cross-architectural control of the entire system.

It is understood that any such solution should meet and, if possible, exceed all the rigorous automotive quality standards for technology, production and testing, while providing advanced diagnostic capabilities. The solution must also meet the Automotive Safety Integrity Level (ASIL) standard so that it is useable not only for interior but also for functional lighting applications. Apart from displays, LEDs will also play a key function in future autonomously driven cars by informing both the driver seated inside the car and the pedestrians outside about the current state of the autonomously driven vehicle. Thus, every LED must precisely convert all electrical control signals into the target color and brightness, whilst enabling the verification of such emitted light to ensure that it exactly matches the specifications set by the control signals.

**Figure 4:**  
Present state-of-the-art RGB LED lighting concept

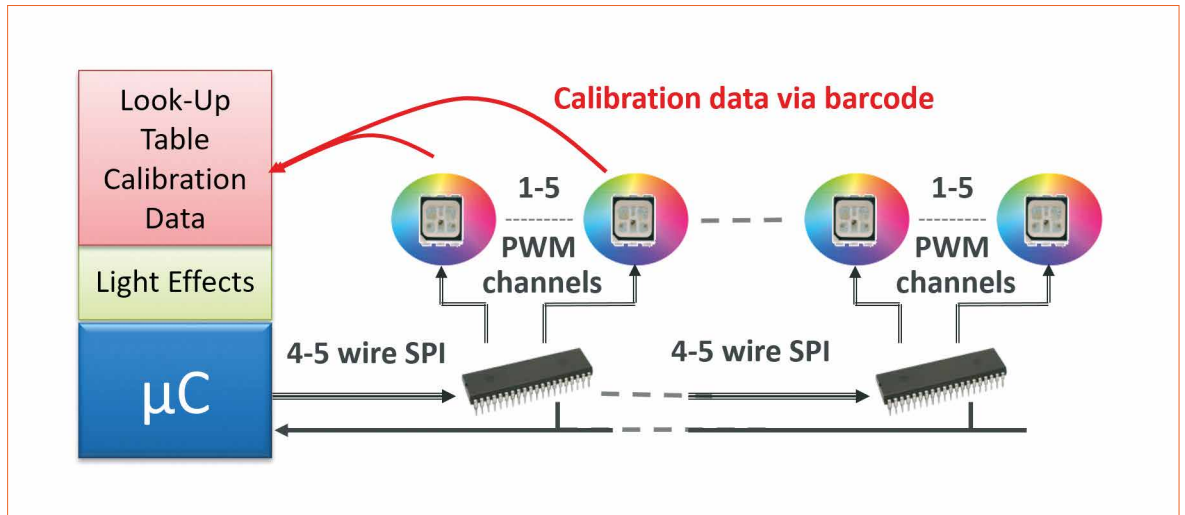

**Figure 5:**  
The new “Digital LED” controller concept

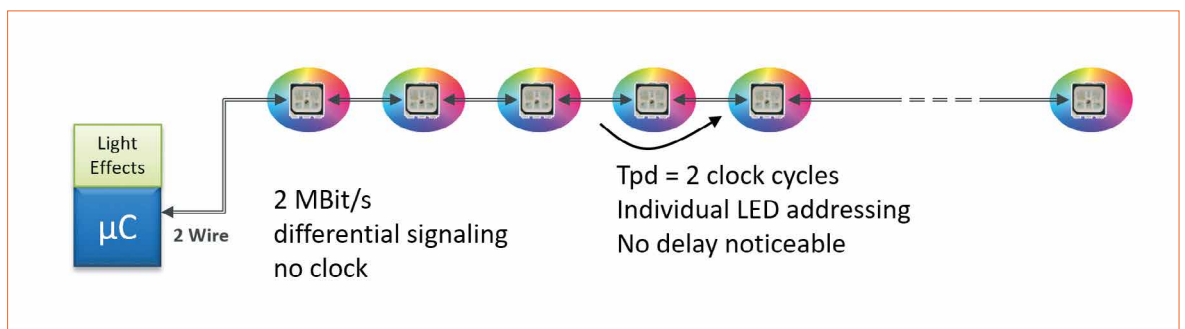

To achieve a high-quality and safe daytime visibility experience, the manufacturer must meet these stringent requirements, whilst providing fine control over brightness and color to guarantee consistent homogenous lighting outputs over the long term. Today's state-of-the-art in-car LED control technology simply falls short, the demands are too great - a new solution must be found.

Presently, every single RGB LED requires individual control via a microcontroller managing LED-specific data gathered for every single LED at production, typically by binning and bar-coding of each LED. The complexity and expense of this approach makes little sense both in terms of the high number of integrated circuits and the extensive wiring - it becomes practically unviable. For this system design (Figure 4) to function, high-speed one-way communication to the LEDs and sub-controllers is required, which logically leads to latency issues, reduces EMI robustness and makes diagnostics difficult. Furthermore, this

cumbersome solution makes the capture of individual LED parameters, such as functionality and temperature degradation exceedingly difficult. The approaches used for LED video walls are inappropriate for meeting the demands of modern high quality in-car lighting.

### The Answer to the LED Complexity Dilemma

The entirely new "Digital LED" concept for automotive applications (Figure 5) is based on an embedded smart LED controller housed in a compact 3x4 mm package together with a red, green and blue LED. The scalability of the solution is set to drive down costs and open up new market opportunities. For in-car applications, it will typically consist of 10-30 LEDs mounted on a flexible light strip. Each of these "Digital LEDs" can be considered as a pixel with 24-bit color resolution (3x8-bit) with capability to render up to 16 million colors, all in true video speed.

The sophisticated calibration

features of this "Digital RGB LED" with embedded controller will eliminate the need for binning classes or bar coding. Every LED now renders the same color and brightness over the full temperature range to deliver highly consistent illumination even at currently unattainable LED manufacturing tolerances. Look-up tables and calibration are also eliminated since LED calibration data is already stored inside the embedded controller.

A newly developed proprietary high-speed communications protocol allows every LED to be individually addressed, and with data rates of up to 2 Mbit/s, promises fast, dynamic in-car lighting effects.

Now, a single microcontroller (Figure 5) can easily manage an LED strip containing up to 4,096 LEDs with each "Digital" RGB LED now having its own embedded controller (Figure 6). Very low latency, two-way communication between the system microcontroller and each individual "Digital LED" at a speed of 2Mbit/s,

without a dedicated clock and differentially transmitted, by default delivers high EMI robustness. All LEDs can be addressed both individually and in groups, as required.

The temperature, status and functionality of each LED are monitored individually, thus bringing a new level of diagnostic capability. Full retrospective retraceability of function and power consumption for each LED is a key feature for automotive ASIL-compliant lighting.

### First Smart LED Products See the Light of Day

This new "Digital LED" is successfully built and samples have been available for some time. Since all the LEDs are factory-calibrated to the required white point, they can be installed without any further calibration or measurements.

To control the red, green and blue LEDs, the driver intelligently utilizes three constant current mode (CCM) drivers and each RGB LED 'trio' can be set with 24-bit resolution (3 x 8 bit). For binning, i.e. temperature and manufacturing tolerance compensation, the brightness of each LED is controlled with 12-bit resolution. The LEDs have precise RGB calibration up to 1-step MacAdams Ellipse, coupled with high-temperature auto-compensation and dominant wavelength calibration (Figure 7). To meet automotive-level safety specifications, the calibration values of the CCM LED drivers and temperature compensation parameters are securely stored in the non-volatile memory of the embedded controller.

### Compact Packaging and Powerful Software

The compact package provides exceptional corrosion resistance and ESD protection exceeding 2 kV. The LED housing has a low thermal resistance - 30% below comparable products, which, thanks to the improved light efficiency of cooler LEDs, further lowers power consumption (Figure 8).

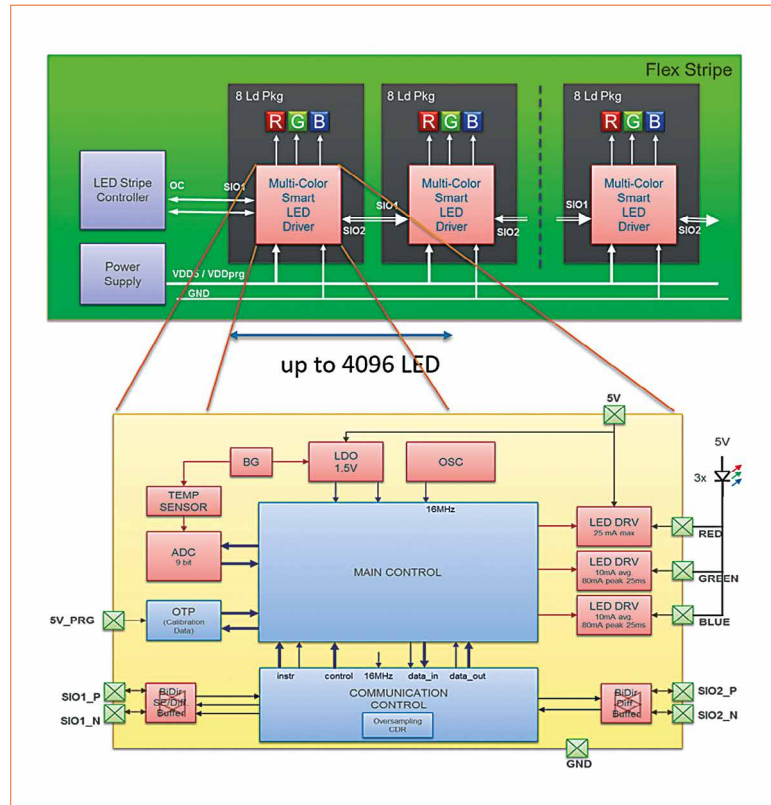

Figure 6: Digital RGB LED with embedded driver and connectivity system concept for up to 4,096 LEDs

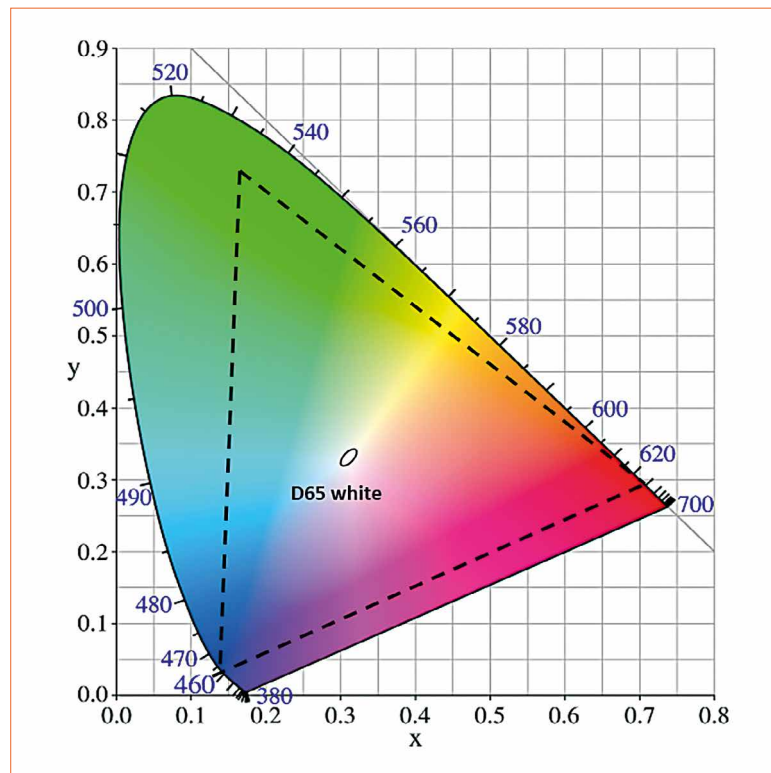

Figure 7: Calibrated LED color space

A microcontroller forms the system interface acting as the lighting controller (Figure 5). Mastering system-level challenges, the recently announced S32K microcontroller product line neatly aligns with the new concept, delivering performance of up to 112 MHz, a FlexIO configurable serial communication

interface, 8K to 2M Flash and an ARM Cortex M core. This new platform is a complete solution that includes hardware, software and ecosystem development.

For communicating with the LEDs' integrated drivers, a stable, well-defined Application

**Figure 8:**  
Compact packaging

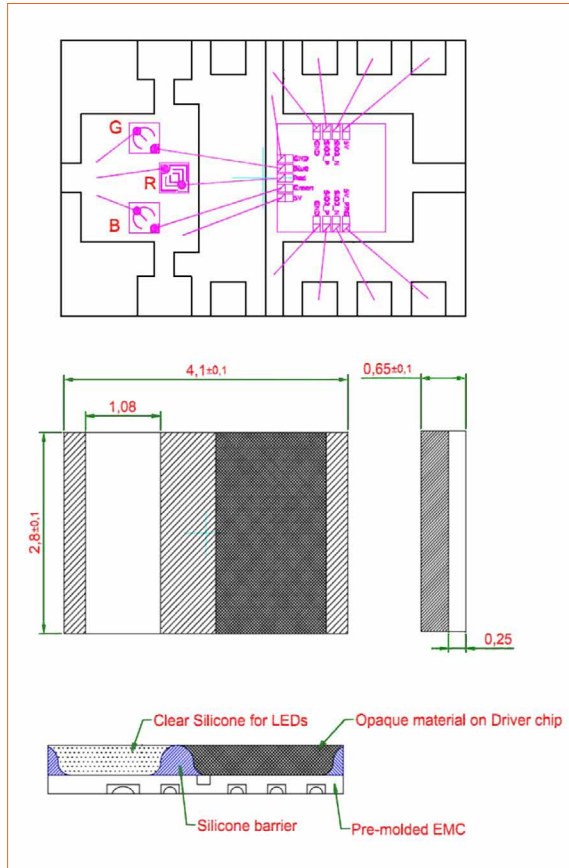

Programming Interface (API) with ready-to-use subroutines significantly simplifies the programming of advanced lighting effects.

A software platform provides firmware, a software development kit (for iOS and Android) and a cloud environment. Inside the vehicle, the firmware takes the function of a control center, linking control elements (smartphone, console unit, ADAS) with the ISELED LED system. The platform incorporates instructions for triggering the lighting effects predefined by the car manufacturer for a specific event and LED locations.

The software development kit enables car manufacturers to develop their own unique personalized applications, where an end-user can adjust LED characteristics using their smartphone for a specific area inside their vehicle. Third party applications, such as Waze, can also be utilized.

Engineers and designers can use the cloud to store a library of lighting effects, which can later be triggered by a specific event and can apply to any LED location in the car.

### A Bright Future Ahead

Automotive interiors are the initial target market for the new ISELED concept. However, the inherent flexibility of this new concept enabled by its control over individual LEDs makes it a prime candidate for a host of varied applications, such as car exterior signaling, passenger trains, aircraft, cruise ships and many more.

This new LED control platform is sure to open up many avenues for making products more attractive, intuitive and sellable. ■



Satisfying the demand for personalized interior ambiance, not just in the luxury car segment (like the new BMW 7 series), has become easier to achieve and more affordable with this new approach



# Looking for **NICHIA** LEDs? Find them at **LUMITRONIX**!

LUMITRONIX – No. 1 Nichia Distribution Partner in Europe.  
Since 2011 for Germany. Since 2016 for all Europe.



Visit us

**LpS 2017**

**LED SYMPOSIUM**  
professional +EXPO

Bregenz 26-28 Sep 2017, Booth A14

**light|ing|technology**

systems :: components :: devices

Messe Essen 10-12 Oct 2017  
Booth 1-332

 **NICHIA**



NFSL757GT-V2 /  
NFSW757GT-V2

**New Nichia 757G-V2 Series**

**Even brighter and more efficient**

- 200 lm/W at 5000 K, CRI 80
- Excellent price / lumen ratio
- Pb-free reflow soldering application
- Built-in ESD protection device
- RoHS compliant

**Request your free samples now!**  
> [www.bit.ly/Nichia757sample](http://www.bit.ly/Nichia757sample)



## LED professional Review (LpR) - Annual Subscriptions

### LpR Digital Magazine

- 6 issues
- pdf download
- high resolution pictures and graphs
- printable
- commercial use
- access to all previous issues
- Euro 78.80

### LpR Printed Magazine

- 6 issues
- Euro 158.40

<http://www.led-professional.com/subscription>

## Cover-page

Artwork: Thomas Klobassa,  
©LED professional 2017

Main Image: Arno Grabher-Meyer,  
LED professional

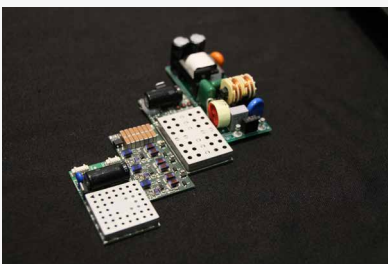

Evolution steps from a conventional driver concept to the HF drivers from Nordic Power Converters as presented at the LpS 2016

## Next LpR

DESIGN & ENGINEERING  
Issue 63 - Sept/Oct 2017

### RESEARCH

“Best Papers” at LpS 2016:  
Measurement of Angular and Spatial Resolved Spectral Rayfiles Using NF Goniophotometers and Optical Filters

Recently, a realistic light source modelling during the optical design process of LED-based luminaires has become more important. The authors propose a method to enhance the often-used LED light source model “rayfile” towards a “spectral rayfile”. The proposed method requires at least one spectral measurement and just a minimum of goniophotometric measurements with different optical filters. The potential and applicability of the method will be demonstrated. ■

### TECHNOLOGIES

Laser Diode Pumped Phosphor Sources for Spatially and Temporal Dynamic Lighting

In many applications, solid-state lasers would be the best technical solution but until recently the costs were much too high. Nevertheless, this technology had its niches and is broadening the field of applications entering different specialty lighting, display, and automotive applications. The article especially describes and explains the technology of laser diode pumped phosphor sources that are, for example, used in high-end automotive headlights of luxury cars. ■

QD LEDs – Red QDs Boost High Quality LED Lighting Efficiency

QD based LEDs have shown promise for over a decade after the first demonstration of color conversion with a blue LED. But they also had several drawbacks that limited the usability in general lighting applications like temperature-stability. The article is concerned with the latest generation of QDs with significant stability improvements. QD LEDs with 20 W/cm<sup>2</sup> of incident blue light and QD temperatures over 110°C have passed 3,000 h and continue to show no degradation. It will be explained why the use of red QDs has advantages over conventional red phosphors. ■

### QUALITY

Lighting to Achieve Optimal Appearance

Visual appearance of an object or space depends on the characteristics of the lighting applied. The objective definition of light quality often doesn't tell the whole story. Light intensity, its spectral composition and distribution in space, as well as individual preference, must be considered. Nevertheless, aiming for the absolute optimum is only recommended when private rooms are concerned. As visual appearance is key in driving consumer demand, it is important to tune the light to maximize effectiveness and visual pleasure for most consumers. This complex situation is discussed with examples. ■

subject to change

## Imprint

LED professional Review (LpR), ISSN 1993-890X

### Publishing Company

#### Luger Research e.U.

Institute for Innovation & Technology  
Moosmahdstrasse 30  
A 6850 Dornbirn, Austria / Europe  
phone +43 5572 39 44 89  
fax +43 5572 20 60 70  
info(at)lugerresearch.com  
www.lugerresearch.com

#### Publisher

Siegfried Luger +43 699 11 33 55 70  
s.luger(at)led-professional.com

#### Editor-in-Chief

Arno Grabher-Meyer +43 699 11 33 55 18  
a.g-m(at)led-professional.com

#### Int. Account Manager

Theresa Koenig +43 699 11 33 55 20  
theresa.koenig(at)led-professional.com

#### Marketing & Sales Manager

Theresa-Anna Luger +43 699 11 33 55 19  
theresa.luger(at)led-professional.com

### Your Local Contacts

#### China, Hong-Kong

Iris Yuen +86 1380 27 01 367  
irisyuen88(at)gmail.com

#### Germany & Switzerland

Armin Wezel +49 30 526 891 92  
armin(at)eurokom-media.de

#### India

Priyanka Rai +91 124 478 7331  
priyanka.rai(at)binarysemantics.com

#### Japan

Eiji Yoshikawa +81 3 6751 0090  
scala(at)s3.dion.ne.jp

#### South Korea

Jung Won Suh +82 2 78 58 222  
sinsegi-2(at)sinsegi-media.info

#### Taiwan

Leon Chen +886 2 256 81 786-10  
leon(at)jkmedia.com.tw

#### United Kingdom, France & Benelux

Zena Coupé +44 1923 85 25 37  
zena(at)expomedia.biz

#### US East

Karen C Smith-Kernc +1 717 397 7100  
KarenKCS(at)aol.com

#### US West & Canada

Alan A. Kernc +1 717 397 7100  
AlanKCS(at)aol.com

## Copyrights - Luger Research e.U.

The editors make every reasonable effort to verify the information published, but Luger Research e.U. assumes no responsibility for the validity of any manufacturers, non profit organizations or individuals claims or statements.

Luger Research e.U. does not assume and hereby disclaims any liability to any person for any loss or damage caused by errors or omissions in the material contained herein, regardless of whether such errors result from negligence, accident or any other cause whatsoever. You may not copy, reproduce, republish, download, post, broadcast, transmit, make available to the public, or otherwise use LED professional Review (LpR) content without prior written consent from Luger Research e.U. - Institute for Innovation & Technology, Austria. ■

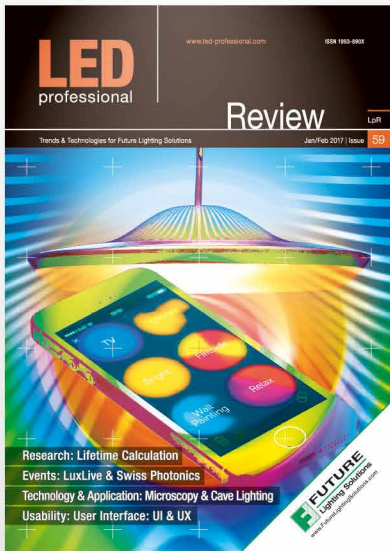

**!** GET YOUR FREE E-MAGAZINE  
[www.led-professional.com/free](http://www.led-professional.com/free)



# The Global Information Hub for Lighting Technologies

LED professional is the comprehensive publication and platform, connecting experts in the design, testing and production of the latest lighting technologies information from around the world.

**LED**  
professional

MORE THAN  
**31,500**  
READERS

[www.led-professional.com](http://www.led-professional.com)

# ACEVEL



IP50

