



**Unified Glare Rating** Page 30  
**Photobiomodulation** Page 34  
**The Perfect Light** Page 48

INTERVIEW **Jürgen Honold**  
RESEARCH **Flicker, Thermal Management**  
TECHNOLOGIES **Tunable Spectrum, Innovative Drivers**  
APPLICATIONS **LED Implementation, Track-Lights**

**Global Lighting Directory**  
Your Comprehensive Guide to the Lighting World  
[www.gld.lighting](http://www.gld.lighting)





# Advance Xitanium LED Drivers with ComfortFade

Now available in 30W, 40W, 50W and 75W Models

## Features & Benefits

- ComfortFade Technology for Smooth Dim to Off Functionality
- Auxiliary Power Supply for Third-Party Sensors
- SimpleSet NFC Based Programming
- 1% Minimum Dim
- 0-10V Dimming
- CSA, ETL, and UL Class P
- 50,000+ Hour Lifetime<sup>1</sup>
- 5-Year Limited Warranty

## Applications

- Indoor Linear
  - Troffers
  - Suspended
  - Retrofit

Advance Xitanium LED drivers are manufactured to engineering standards correlating to a designed and average life expectancy of 50,000 hours of operation at maximum rated case temperature. Minimum 90% survivals based on MTBF modeling.

For up to date warranty information please go to <https://www.signify.com/en-us/support/warranties>

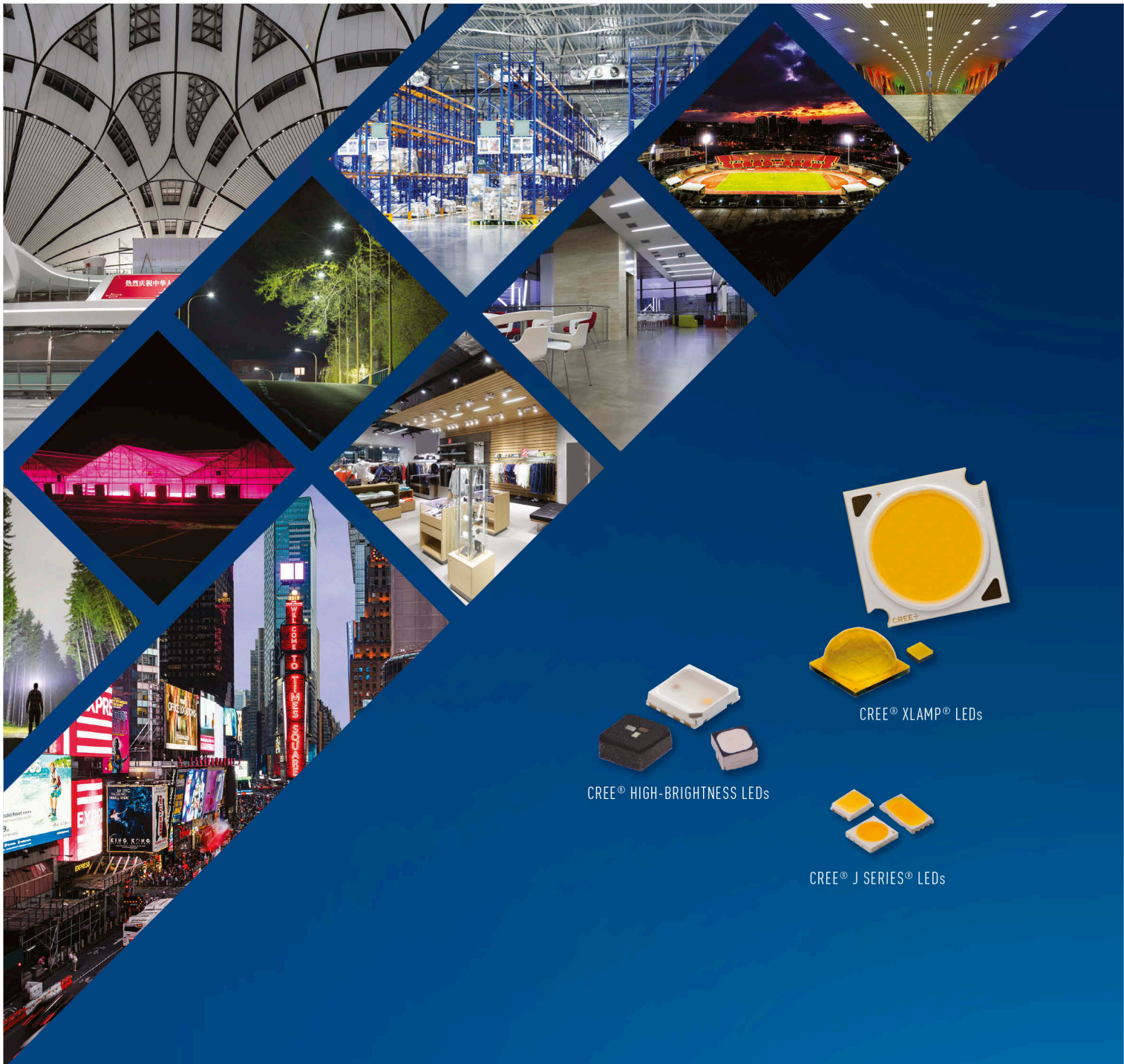


[www.FutureLightingSolutions.com](http://www.FutureLightingSolutions.com)

Come visit us at LightFair 2020  
May 3-7, 2020  
Las Vegas Convention Center, Las Vegas, NV

**ADVANCE**

by **signify**



CREE® XLAMP® LEDs



CREE® HIGH-BRIGHTNESS LEDs



CREE® J SERIES® LEDs

# WE STARTED THE LED LIGHTING REVOLUTION —AND NEVER STOPPED.

MORE RELIABLE.  
MORE PERFORMANCE.  
MORE OPTIONS FOR MORE APPLICATIONS.

SEE THE COMPLETE PORTFOLIO AT: [CREE.COM/LED-COMPONENTS](http://CREE.COM/LED-COMPONENTS)

**CREE** 



# Individualization of Connected Lighting

Do we really understand the mechanisms of how light influences us physically or what effect it has on our well being, in general? The "one-size-fits-all" approach is by no means the right one. An important factor is to adapt and tune the spectra of a lighting solution over time and/or over application specific conditions; spectra-conditional lighting, so to speak. This issue includes an article by Dr. Stephen Mason, entitled "In search of the perfect light". In it he discusses important background information pertaining to these types of questions and statements.

Of course there are more parameters to adjust, such as light output, light level and brightness, which are all essential elements of an optimized and adapted system. Furthermore, as we know, there are a lot of investigations, products and systems available to mimic the spectra of daylight / the sun.

Daniel Han from Beijing Yuji International explains a new method for tuning an LED spectrum through different phosphor compositions.

In the on-going EU funded Repro-light project, researchers invented a so-called Personal-Table-Light (PTL) to optimize light directly at a specific/individual work place. LED professional will report about these developments and the findings in coming issues.

The individualization of lighting is a huge trend in the field of Human Centric Lighting. For this reason a lot of lighting parameters are tuned to fulfil the physical, well-being and task requirements for a lighting situation. It is understood that only connected lighting systems will fully benefit from all adaptation opportunities.

The individualization of connected lighting systems.

Yours Sincerely,

Siegfried Luger

Luger Research e.U., Founder & CEO  
 LED professional, Trends in Lighting & Global Lighting Directory  
 Photonics21, Member of the Board of Stakeholders  
 Int. Solid-State Lighting Alliance (ISA), Member of the Board of Advisors



**RÖHM**

**Light makes the  
atmosphere.  
And PLEXIGLAS®  
makes the light.**

Light not only attracts insects and other animals, but also customers. That's because PLEXIGLAS® can be molded in almost any number of ways, opening up entirely new possibilities for product design. Yet using PLEXIGLAS® also pays off for other reasons: it transmits light very efficiently and is particularly long-lasting and UV-stable. Find out how else PLEXIGLAS® shines by visiting [www.plexiglas-polymers.com](http://www.plexiglas-polymers.com).

**PLEXIGLAS®**  
THE ORIGINAL BY RÖHM

4 EDITORIAL

**COMMENTARY**

8 **Why Comfortable Lighting Needs New Quality Parameters**  
by Kenneth MARTIN, Dipl.-Ing.(FH), Light Source Specialist at Zumtobel Group

**NEWS**

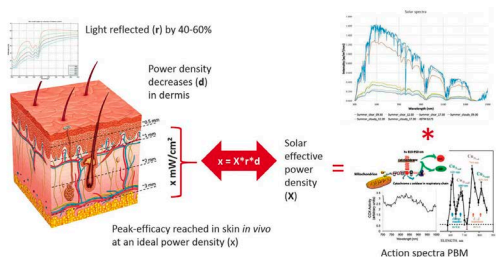
10 **International Lighting News**  
29 **Regulation News**

**UNIFIED GLARE RATING**

30 **Discomfort Caused by Glare from Luminaires with a Non-Uniform Source Luminance**  
by Peter THORNS BSc(Hons), CEng, FCIBSE, FSLL, Head of Strategic Lighting Applications and Global Lighting Applications at Zumtobel Group

**PHOTOBIMODULATION**

34 **Jürgen HONOLD, Program Director at Seaborough Life Sciences, The Netherlands**  
compiled by Arno Grabher-Meyer, LED professional



**FLICKER DIRECTIVE**

42 **New Directive in Europe: Flicker of LED Lighting**  
by Peter Erwin, CEO and Design Engineer at Der Lichtpeter

**THE PERFECT LIGHT**

48 **In Search of the Perfect Light**  
by Stephen MASON, Dr., Managing Director at Sustainable Eye Health

**TUNABLE SPECTRUM**

54 **A New Method to Tune an LED Spectrum**  
by Daniel HAN, Business Development Director at Beijing Yuji International

**CIRCADIAN ENTRAINMENT**

60 **LED Lighting for Circadian Entrainment**  
by Bill CHAN, M.Sc., President of LiteController

**LED TECH IMPLEMENTATION**

64 **How to Implement the Latest LED Technology for a Successful Application**  
by Marc JUAREZ, Technical Director Europe of Seoul Semiconductor

**Measurement Devices | Advertorial**

68 **Integrated Solution for Human Centric Lighting (HCL) / Integrative Lighting Assessment**  
by Gigahertz-Optik

**THERMAL MEASUREMENT**

70 **Challenges for Measuring Multichip LED Light Engines for Interior Lighting Applications**  
by Mete MUSLU, MSc, Research Assistant at Ozyegin University

**DRIVER EFFICIENCY**

76 **How to Increase the Efficiency of Two-Stage Drivers**  
by Dr. Michael WEIRICH, Senior Manager Application Engineering at Infineon Technologies

**TRACK-LIGHT DRIVER**

80 **Designing an Invisible Driver for High-End Track Lights**  
by Mickey MADSEN, Dr., CEO of Nordic Power Converters

86 **ABOUT | IMPRINT**

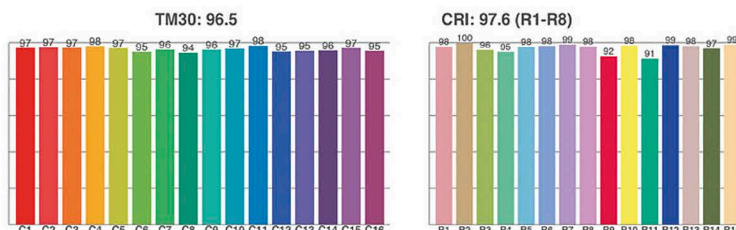
**ADVERTISING INDEX**

1 Global Lighting Directory	15 Cree	63 GILE 2020
2 FLS-Signify	21 Instrument Systems	75 Repro-Light
3 Cree	23 ENZ	79 Repro-Light
5 Röhm	24 Cezos	85 LED professional Review
7 Seoul Semiconductor	33 Nichia	87 Editorial Calendar
9 FLS-Nichia	40 TILS 2020	88 Global Lighting Directory
11 Trends in Lighting	41 Lightfair 2020	
13 Toplite	53 Sustainable Eye Health	

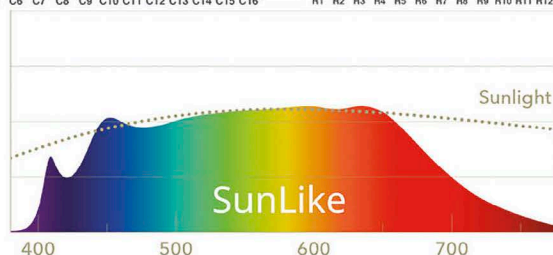


# WE BRING YOU THE SUN<sup>LIKE</sup>

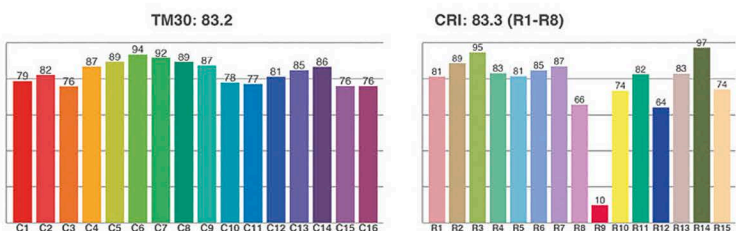
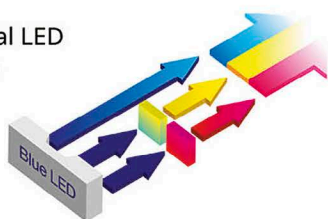
## The only TRUE solution for Circadian Lighting



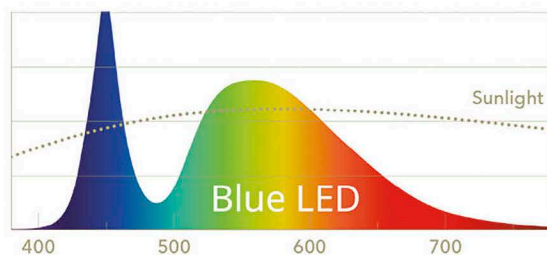
No UV  
 No Blue Peak - M-EDI like D65  
 Best Colors at any CCT  
 Following the Sun spectrum



Traditional LED  
 Blue chip



Big Blue Peak  
 Very Low M-EDI (490nm)  
 Low color rendering  
 No natural spectrum



[info.europe@seoulsemicon.com](mailto:info.europe@seoulsemicon.com)

[www.seoulsemicon.com](http://www.seoulsemicon.com)





### **Kenneth MARTIN, Dipl.-Ing.(FH)**

**Kenneth has been specifying, qualifying and developing components and characterization setups for LED light sources within the Zumtobel Group since 2006. With his expertise on spectral measurements and applications, he supports integrative lighting solutions topics. He gathered valuable knowledge in physics and optical system engineering while studying at the University of Applied Sciences RV-Weingarten, during the internships at a quality assurance department of a reflector aluminum manufacturer and the optical development department of Zumtobel. He combines his enthusiasm for lighting and sustainable construction engineering with a DIY philosophy.**

## Why Comfortable Lighting Needs New Quality Parameters

An important question driving us forward these days is: What effects does light have on us, besides imaging information? Initial scientific indications show impacts via human skin with its melanopsin producing fat cells and the far red light activated mitochondria, but effects on the eyes' cells are still the main focus of research.

Unlike skin, the eyes' reception of light at the single cells of the retinal tissue is regulated by the iris and filtered by its directionality via the lens. Currently, five types of photosensitive retinal cells have been classified: Next to the cones in its three variants that are sensitive to short, middle and long wavelengths, there are also the rods which are most sensitive within the cyan (appearing) wavelength at low intensities. For the past few years we have gotten to know more about the fifth photoreceptors, the intrinsically photosensitive retinal ganglion cells (IPRGCs), containing melanopsin, which is most sensitive to the azure wavelength. These cells also get signals from other cell types, but how all the signals of the cells and from both eyes are combined for the physiological mechanisms is still being researched.

We can describe some average "stimulus" values by spectral irradiation measurements at eye level. But this is only directly comparable to another situation if it has the same relative radiance distribution within the whole visible field. The distribution of the different cell types on the retina and their relative degree of saturation may play an important role on the reactions. That's why absolute readings of lux, W/m<sup>2</sup>, cd or cd/m<sup>2</sup> are usually non-transferable without further ado. The spatial and spectral distribution of the signals from the retinal cells - a kind of histogram - is the minimum required information from a hyperspectral imaging measurement, to seriously describe the effects in detail.

Like a video camera, the eyes don't have the possibility to greatly alter the signal integration time along the intensity levels. Instead, there is an impulsive pupillary reflex and a slower steady state pupil size regulation, optimizing the irradiation level at the retina and protecting it from excessive intensities. Other physiological effects are the main adaptation level (chromatic and brightness perception) and melatonin suppression. Those effects react to the "histograms" of the relative stimuli magnitudes of the five different photoreceptor types, and therefore on the spectral and spatial distributions of the reflected light.

When we focus our vision e.g. at work, the light that we receive, should be optimized so that we have the widest color and lightness contrast sensitivity range. And it should also induce the right non-visual effectiveness and the lowest strain level on the retinal cells, supported by correctly functional physiological mechanisms.

Based on the numerous new research results, we need to question whether illumination based regulations and quality standards should be replaced. To include long-term effects of light on health and stress to the eyes, we need new quality criteria based on the active photoreceptor stimulus distributions.

Contrasts from bright spots should not be excessive nor should there be reduced object color contrasts and brightness gradients. Nowadays, most people have a smartphone that can roughly calculate lighting quality by the camera pictures' histogram data. At good values of new quality criteria, it should be possible to easily make acceptable snapshots without effects from glaring lights or flicker – even at night. It helps if lighting is not just vertical or diffuse but also has one visible inclination. ■

K.M.





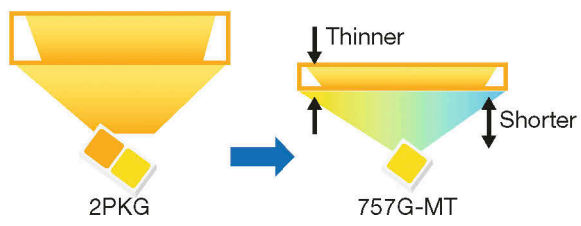
NF2W757G-MT

# White Tunable 2-in-1 757

## Color Tuning

All color tuning designs currently utilize two LEDs making them bulkier and doubling the size. Therefore, optical design is very difficult and less than efficient.

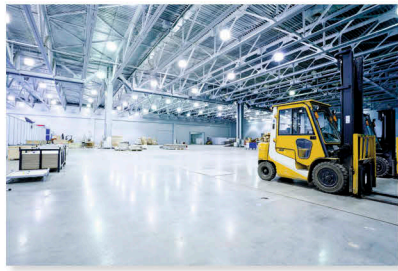
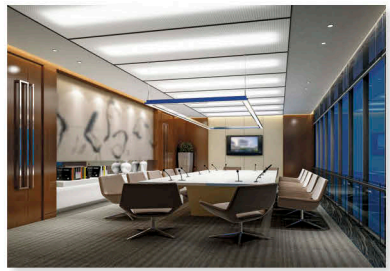
Now, with a single light emitting surface LED, designs can be sleeker, thinner, more efficient and optic free!



## Operational Freedom

Instead of carrying inventory of every CCT to support customers, manufacturers now only need one product. The CCT can be set at the time of order, at shipment or even during installation. If the project CCT changes, no problem.

## Color Flexibility Simplified



## APPOINTMENTS

## New Senior Lighting Designer At Atkins

**Kristina Allison** has worked in the lighting industry as a designer and consultant for 13 years and has been recently promoted to senior lighting designer, in the Atkins Global specialist lighting team in London. Her most recent projects include; London City Airport expansion and Euston Station redevelopment. During her time at Zumtobel (ZG) she delivered numerous lighting projects with the end user retail team including; Jaguar Landrover, London Olympia, Dixons, Bentley Motors and large roll out projects for LIDL retail, Sainsbury's and ASDA.

Previously, Kristina ran her own design consultancy practice, with clients such as the Carbon Trust and the Electrical Contractors Association (ECA). Her experience as consultant included advice for the Building Research Establishment (BRE), Lancaster House, Edinburgh airport, BAA, Greenwich University and lighting designer for the Dementia Services Development Centre (DSDC) and as a guest lecturer at City University in London. Kristina is a Chartered



Engineer, Member of the Society of Light and Lighting (MSLL), Member of CIBSE (MCIBSE) and Chair of the Society of Light and Lighting (SLL) Education committee. ■

## Brad Koerner Joins Cima As Product Development & Innovation VP

Cima announced that **Brad Koerner** will join as Vice President of Product Development and Innovation. Brad is a creative leader in the application of advanced lighting technologies and digital media systems.

Having spent 20+ years in the lighting industry, Brad has developed award-winning (most recent award from U.S. Department of Energy for Manufacturing Innovator Challenge for Sustainable Manufacturing of Luminaires) architectural lighting projects as well as industry-leading LED product lines. Brad previously worked in the Innovation Group at Philips Lighting in the Netherlands, the product management team at Color Kinetics and as a lighting designer in the Boston area. Brad is an accomplished writer and speaker, having presented at over 30 global conferences, forecasting future trends in architectural lighting design. Brad shares: "We



see leading designers fusing lighting, graphics and digital signage to create immersive new experiences across a range of commercial, retail and hospitality applications. But the most daring innovations need a strong base of project management, customer service and production savvy for successful execution on construction projects. The Cima team has worked hard to build excellent project-based services and responsive client support. I'm excited to join the Cima team and also to rejoin my former Color Kinetics colleague Brandon Siemion, with such a solid foundation from which to launch innovative product lines into the specification channel."

*"We see leading designers fusing lighting, graphics and digital signage to create immersive new experiences."*

BRAD KÖRNER

With a North American platform for full turnkey solutions in signage, custom architectural elements, landmarks, graphics, architectural illumination, and digital signage, Cima supports brands, architects and designers across the country.

President of Cima, Bill Lockett, shares his excitement:

"I am proud to announce that Brad Koerner has joined Cima. Brad brings to the team a depth of knowledge in fusing architecture and lighting that is industry leading. His cross-section of experience and education paired with Cima's core capabilities will, without a doubt, cultivate innovative products and services for our clients. There has been a shift in the market and engaging experiences are integrating signage, architecture, digital media, RGB and architectural lighting at an exciting pace. We have a strategic growth plan in place to match this trajectory. Cima is proactively developing new solutions our clients will need to engage their customers, build their brand and accelerate to be top of mind in their respective industry. Brad's high-profile, worldwide, project experiences will help fortify this charge. Cima is a sum of its people and having Brad as a part of our team will elevate us all, projecting Cima to new levels." ■

## Marco Milano Joins Filix Lighting As MD

**Marco Milano** joins Filix Lighting Germany as Managing Director as part of an expansion across European markets. He has many years experience in the lighting industry from his previous role at Stuttgart based Wibre. "A better understanding of what lighting designers need to have in lighting instruments requires constant communication and local presence. Opening this office will help us bring new, more efficient and sustainable solutions to our clients. Marco Milano will give in-depth technical and industry knowledge that will benefit both Filix Lighting and the lighting community" says Marko Jurman CEO. ■

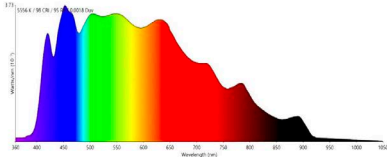
## HUMAN CENTRIC LIGHTING

## euroLighting Expands LED Portfolio with Shenzhen Lightspot Technology Products

euroLighting has expanded its sales program with high-quality light-emitting diodes in SMD package and COB-LEDs. To this end, the LED specialist concluded a distribution agreement for Europe with the company Shenzhen Lightspot Technology Ltd., also known under the product name SMART ECO LIGHTING. euroLighting is presenting these new LED products for the first time at light+building 2020.

**Features:**

- In the LED spectrum, the blue component that is harmful to the human eye has been reduced to a normal level of the sun
- The wave range around 460nm, which is particularly important for reading, as well as the red and infrared spectrum, which are very important for the human body, were amplified



The light spectrum of light emitting diodes from Shenzhen Lightspot Technology covers a range from 360–1000 nm. The LEDs are available from euroLighting

Since 2018, Shenzhen Lightspot Technology Ltd. has been working on a physiological lighting concept based on the light spectrum of the sun. It includes the normal life processes in the body cells of humans, animals and plants, i.e. the interaction of all physical, chemical and biochemical processes in the entire organism. The aim was to use light not only as a source of illumination for objects and for human vision, but also to study the biological effects of the solar spectrum on humans, animals and plants and to copy it successfully. Thanks to intensive research and development light emitting diodes in the wavelength range between 360 und 1000nm have been developed. euroLighting now equips various light sources, including LED screw-in lamps, T8 tubes, LED panels and other light sources, with these new LEDs.

**The Optical Window:**

The range of solar radiation visible to humans is limited to the range between 430–780 nm. However, the human skin has a so-called "optical window" in the range of 600–1400 nm, through which humans receive their energy for daily life via solar radiation. This is because two-thirds of the energy that every person needs per day is provided by the electromagnetic waves of the solar radiation spectrum.

**Energy via LED:**

Through internal research, Shenzhen Lightspot Technology has successfully managed to increase the solar spectrum reproduced by its light-emitting diodes to as much as 950 nm, thereby providing people with at least a fraction of the energy they no longer receive in everyday life.

Because the daily dwell time of humans in the sunlight has been reduced by the modern way of life to about 20%.

**Health benefits:**

The new generation of light-emitting diodes significantly improves human vision, especially for older people, also sleeping behavior, the ability to concentrate and the feeling of well-being. Many users of the new lamps confirmed the positive effects of the artificial solar spectrum. Even though these effects have been known for a long time, intensive research and development has now made it possible to develop this new generation of energetic light emitting diodes. ■

**SOLID STATE LIGHTING**

**Berlin By The Sea**

Trends in Lighting caught up with the BuroHappold Engineering Design team in Berlin who support local artists through collaboration. This gives the designers the opportunity to experiment and explore the possibilities of light. The Berlin team have most recently worked with artist Monika Goetz to bring her installation 'Friedrichshain by the Sea' to life. Monika



created the art installation at the Alte Feuerwache (old fire station) in Friedrichshain, Berlin, out of reused wine and champagne bottles. She arranged the bottles and the colours between the arches to form a water landscape.

*"The title of the work refers to the increasing environmental pollution."*

MONIKA GÖTZ

Collaborating with Monika on the lighting for the installation gave the lighting designers the freedom to experiment with

**Join the Lighting Design Community**

Subscribe to the monthly Trends in Lighting Newsletter

Stay up-to-date

[www.trends.lighting](http://www.trends.lighting)

light and reveal different aspects of the piece, its shape and materials. The installation is particularly interesting as it combines different types of lighting (diffused and focused) and different colours (warm and neutral) in order to reveal the colour and the glossy surface of the glass bottles.

As well as lighting the installation, the Lighting Team also altered the exhibition room lighting to suit the artist's design intent. As the visitors moved around the room, their attention was drawn to several different aspects of the installation: the colour of the bottles, the glossiness of the glass, the projected colours on the floor, the shadows of the bottles projected into the exhibition room, and the density and transparency of the material viewed from different perspectives.

It is clear that Friedrichshain is not by the sea. The title of the work refers to the increasing environmental pollution and 'plays' with the idea of what would happen if the water levels were to rise so high that Friedrichshain was by the sea.

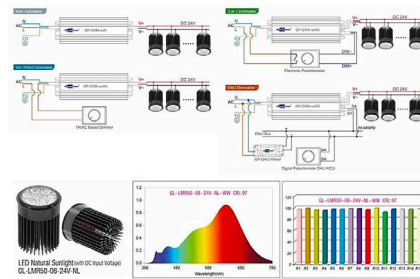
Projects like these centred around sustainability and experimentation provide lighting designers with a platform to develop and influence the future of lighting. Photo credit: Burohappold Engineering ■

## GlacialLight Introduces New Natural Sunlight GL-LMR50-06-24V-NL with DC Input Voltage

GlacialLight, the LED lighting division of GlacialTech Inc., announces the natural sunlight GL-LMR50-06-24V-NL with DC 24 V of 3000 K warm white. With a CRI of 97, as well as the CQS (Color Quality Scale) is up to 97. The color fidelity index (TM-30-15 Rf) and color gamut score (TM-30-15 Rg) are close to natural sunlight. It can be non-dimmable and dimmable when given the appropriate DC electrical signal; the brightness can be freely adjusted with DC constant voltage PWM signal. GlacialPower GP-CVM constant voltage series driver provides non-dimmable and most popular three dimming functions include AC-TRIAC dimming, 3-in-1 dimming and DALI dimming for greater lighting flexibility and are suitable for GL-LMR50-06-24V-NL.

The GL-LMR50-06-24V -NL offers the round and square single housing in black and white colors for optional. The beam angle comes in 15°, 24° and 36° degrees, making this new product a flexible lighting solution for any space. The elegant, simple design with a rounded lighting fixture makes it perfect for creating the lighting atmosphere. The GL-LMR50-06-24V-NL is well suitable for use

as spot lighting, residential lighting, commercial lighting, hallway lighting and cabinet lighting. The GL-LMR50-06-24V-NL



The GL-LMR50-06-24V-NL is the latest addition to GlacialLight's "Natural Sunlight" portfolio to mimic sunlight also in warm 3000 K CCT

features a mistake-proofing design to connect a DC 24 V power input to make it user friendly. The installers do not need to distinguish the polarity between the positive and the negative poles of power input; it easily makes and avoids damaging the units with wrong polarity power input. This new product also comes in a parallel expandable design. It can directly connect lots of DC lighting fixtures with one constant voltage driver if it provides enough watts. It saves extra LED drivers fee and working hours.

The natural sunlight GL-LMR50-06-24V-NL with high color rendering index 97 produces a continuous spectral distribution across all wavelengths and no color gaps, just like the spectral distribution of sunlight. It is uniquely designed with full spectrum technology so you can see each color as natural light and always real. ■

## Osram's New Blue High-Power Laser for Lighting Applications Provides Breathtaking Moments at Events

Rock and pop shows today are about much more than music. The entertainment factor, including numerous show elements, is becoming more and more important in concerts in big stadiums and event halls across the world. State-of-the-art stage lighting plays an essential role in these shows. Numerous manufacturers rely on lighting solutions from Osram to create memorable experiences. A new blue high-power laser is now expanding the range of options available to manufacturers of show lasers and stage spotlights.

The PLPT9 450LA E from Osram Opto Semiconductors is a multimode laser diode that is mounted in a hermetically-sealed TO metal can package. Lasers combine an

outstanding form factor with excellent beam quality – making them particularly suitable light sources for show lasers and stage lighting.

In terms of brightness, laser diodes offer some advantages over LEDs. At a typical operating current of 2 A, the PLPT9 450LA E achieves an optical power of 3.0 watts and emits blue light with a wavelength of 447 nm. In a typical optical system, the laser light is focused at a point only a few micrometers in diameter. The laser can be directly used as a blue light source or in combination with a special phosphor for white conversion. The achieved luminance of the white light source is around three times higher than that of a comparable LED.

The PLPT9 450LA E comes in the proven, robust TO90 package. Compared to the first TO56 generation that included three pins, the new TO90 package contains only two pins for contact. Thanks to the simpler cooling, the generated heat can be easily dissipated from the component. In addition, the integration of the laser into the final lighting solution is much less complicated. "The PLPT9 450LA E



Osram is expanding its photonics portfolio for stage lighting: The new high-power blue laser enables breathtaking lighting solutions for events

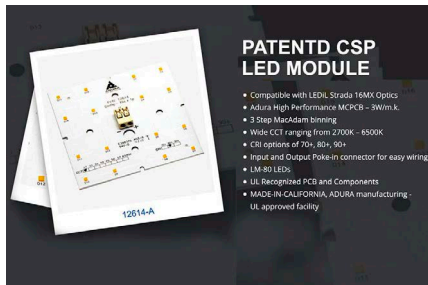
completes our broad portfolio of InGaN lasers with a 3-Watt version. Thanks to the easier cooling, an application range up to 85°C and an operating voltage of less than 5 V, we are able to offer our customers particularly small and lightweight designs of high-quality lighting solutions for show lasers, endoscopy, professional laser torches and other numerous applications," explains Christoph Walter, Product Manager for Visualization & Lasers at Osram Opto Semiconductors. ■

## Aura LED Solutions Presents New Patented 16MX CSP Modules

Aura LED Solutions, a leading Southern California manufacturer of LED Lighting modules introducing the new patented 16MX Family of LED modules with CSP LED. The new 16MX modules are available with low, mid, and high power CSP LEDs and are offered today with Nichia (E17/E21), Cree

XD16, Samsung (LH181B/LH231B) and Seoul Semiconductor Y19.

The patented 16MX modules are offered from 2200–6500 K and CRI options of 70+, 80+, 90+. Adura offers compatible lens options from LEDIL (Type 2, T3, T4, T5), 16MX Heatsink, Graphite Thermal Interface Material (TIM), ready to be used for photo-type or production quantity. Adura manufacturing



Adura LED Solutions latest CSP module, the 16MX, is a powerful 16-LED CSP module with a typical operating current from 700-1500 mA at 48 V

facility in Southern California is a UL certified and ISO9001 recognized. With recent tariff charges and shipping cost from China to USA, take advantage of LED modules Made-in-California with the highest quality and very competitive pricing. ■

## Upwertek Released Compact 60-100 W CV LED Driver with Input Over Voltage Protection Function

Upwertek released the new compact BLD series constant voltage LED drivers which cover the range of 60-100 W. The new series adopted the latest technology, and more functions are integrated to make them more compact. The size is only 102x68x38.5 mm, which is also the reason to be competitive on cost performance. Input over voltage



Upwertek's new 60-100 W constant voltage LED driver offers many interesting features while being very compact

protection function is available on the new products and it increases the reliability to a much greater level to handle input surge. The LED driver will shut down to protect itself if the

input voltage is higher than 320Vac and recovers when the input goes back to normal.

The major 12 V and 24 V constant voltage models in both series are widely used for signage and light box applications, also they can be used for LED strips in indoor usage. Certified by UL, BIS, ENEC and CB, the products will reach most of the global market. ■

## Gigahertz-Optik's PLL-1701 High-Speed Transimpedance log/lin Amplifier Offers Internal Integrating Sphere

With its new high-speed transimpedance amplifier PLL-1701 Gigahertz-Optik offers a versatile solution for use with either external photodiodes or its internal integrating sphere and detector combination. This compact device incorporates both logarithmic and linear amplifiers and can provide an analogue voltage output or a digitized output of the input signal current. Application software is included and an SDK is available for full integration and automation. The PLL-1701



High speed transimpedance amplifier for a variety of applications, includes an integrating sphere

offers nine linear amplifier stages each with an identical rise time of 16µs. The maximum input current is 1mA and output signals can be up to +/- 5V. Additionally, the PLL-1701 offers a single-range logarithmic amplifier which can be used for applications with very fast dynamic fluctuations such as fast positioning tasks or pulsed light sources with very wide dynamic ranges.

The voltage output of the Analogue/Analogue mode (AA) is suitable for use with oscilloscopes and other data acquisition systems (e.g. datalogger). The PLL-1701 also offers an Analogue to Digital Conversion mode (ADC) in which the input current signals are digitized by the internal processor and output via RS422 and USB 2.0 interfaces. Data analysis is done with either the included application software or the available Software Development Kit (SDK).

Evaluation routines for light flicker assessments (including PstLM, SVM, flicker

Guangzhou international lighting exhibition 25<sup>th</sup>  
9-12, June 2020  
Hall: 3.2  
Booth: B12

# MAT Range

New generation LED optic engine for lighting devices

- LED array & high power
- Real high efficiency & first-class color mixing

**TOPLITE**  
NEW OPTIC DESIGN

[www.led3d.com](http://www.led3d.com)  
[www.matoptic.com](http://www.matoptic.com)

frequency, flicker index) are already implemented in the software and also in the SDK and can thus be used directly. Therefore, the PLL-1701 complies with international standards for temporal light modulation (TLM) applications including the EU Ecodesign Directive, CIE TN006:2016, and NEMA 77-2017.

Furthermore, the PLL-1701 has an internal integrating sphere with an extended range InGaAs photodiode. FC-terminated fibers can be directly connected allowing their power (A/W/nm) to be measured in the spectral range from 400-1550 nm. The InGaAs photodiode signal is also output in both AA and ADC modes. ■

## Venture Lighting Introduces Intelligent Outdoor Luminaires Enabled By Synapse Wireless®

Venture Lighting International has partnered with Synapse Wireless®, a leader in wireless lighting controls systems, to enhance the capabilities of several key product lines. Starting with outdoor area lighting, Venture Lighting is now offering intelligent luminaires

enabled by Synapse, to the Environ LED area lighting family and VFlood product lines. Venture is working towards extending the same control capabilities to its LED highbays for indoor, industrial applications as well. Leveraging Synapse's extensive wireless



Venture's outdoor area lights are becoming smart and connected with the Synapse Wireless® solution

control expertise and Venture's existing LED solutions, Venture Lighting is now able to offer an intuitive lighting system designed specifically for outdoor and industrial indoor applications. This combined lighting solution is scalable and future-proof. Its over-the-air upgrade capability ensure components of the lighting system have the latest features and functionality to keep the system updated and robust. This new partnership of Venture and Synapse meets the ever-growing demand of Internet-of-Things (IoT) in the commercial lighting market. ■

## Acclaim Lighting Expands Modular Linear One Series for Interior and Exterior Linear Lighting

Acclaim Lighting, a leader in innovative and advanced solid-state lighting technology, expands its Linear One® Series, which includes low-watt, high-output energy-efficient interior and exterior modular linear LED fixtures in a wide range of color temperatures, CRI and beam angles. With no visible cables, the fixtures create a clutter-free environment.

The Linear One Series utilizes an end-to-end modular design, making it an incredibly adaptive, efficient, and versatile light system designed for linear, low profile, single-color, high-output LED fixtures. The fixtures are ideal for creative capabilities for wall grazing and cove applications to meet design criteria.

Offered in 1- and 4-foot sections in interior and exterior units, the Linear One Series provides modular functionality in three output levels to adapt to various design criteria. Its HO units consume only 12 watts per foot, while the newly introduced SO and EO fixtures use just 8 and 4 watts per foot, respectively.

The Linear One Series is available in newer,

warmer color temperatures of 2100 K and 2400 K, which are in high demand for hospitality spaces. They join the existing options of 2700 K, 3000 K, 3500 K and 4000 K, red, green, blue and amber with a 80 and 90 CRI. Its wide range of beam angles includes 10° x 10°, 30° x 30°, 60° x 60°, 100° x 100°, 10° x 25°, 10° x 40°, 10° x 60°, 30° x 60° and 40° x 70° for custom lighting applications. The series additionally offers 0 to 100 percent dimming through its internal 0-10-volt driver or DMX dimming through an optional universal dimming module (UDM). Assembled in Los



The addition of lower wattage options and warmer color temperatures gives Linear One even more flexibility

Angeles, the Linear One Series operates on a 100-277 VAC power supply. It features a robust aluminum, marine environment housing. The exterior model is IP66 rated for wet locations and performs in -40°F to 131°F (-40°C to 55°C). The interior fixture is IP40 rated for dry locations and performs in -4°F to 113°F (-20°C to 45°C). Both exterior and interior units maintain 70 percent of their lumens for 150,000 hours. The long-lasting Linear One Series has a five-year limited warranty. ■

## LSI Industries Launches New, Commercial-Grade LED Area Lights

LSI Industries has launched two new, high-quality, commercial-grade area lighting solutions. The company's new SSA (small) and SMA (medium) luminaires are quick-ship products that offer enhanced features and benefits for smaller-budget projects. These modern, durable, attractive fixtures are designed for applications that do not require the highly advanced optics and performance associated with LSI's premium line of Mirada area lights.

"Our commercial-grade area lights help us better serve customers who are operating in the entry-level or price sensitive segments," said Mike Prachar, Chief Marketing Officer of LSI Industries. "Those customers are important to us, and we are excited to offer them a high-quality, turnkey solution that can compete, and win, against virtually anything they'll find within their specifications."

The SSA and SMA use standard, high-quality acrylic lenses. With expanded lumen offerings of 21,000 to 38,000, the new fixtures deliver higher light output compared to similar commercial-grade luminaires currently in the marketplace. In many cases, this can reduce the total number of fixtures required for a project – driving down both material costs and installation times. High voltage options are also available, eliminating the need for step down transformers. This flexibility allows both products to be used across numerous applications, creating additional opportunities to enhance project efficiencies and control costs.

With 3000 K temperatures available for all configurations, the new fixtures produce high-quality, warmer light for numerous parking lot and walkway applications. Both fixtures can also be configured with sensors that adjust light levels based on occupancy and ambient light availability. In addition, the new products are compliant with DesignLights Consortium (DLC) premium standards, allowing customers to qualify for energy rebates. They are also compliant with California's Title 24 energy conservation requirements and, when pole mounted, the 3000 K versions are International Dark-Sky Association (IDA) compliant. LSI's new



LSI's two new, high-quality, commercial-grade area lighting solutions are "quick-ship products", designed for smaller-budget projects - also available in 3000 K configurations

commercial-grade area lights are stock items that, depending on configuration, can be shipped within 10 business days after an order is placed. The fixtures can also be ordered with LSI poles, including the company's universal mounting poles for renovation and replacement applications. ■

## Espen Technology Launches Field-Adjustable Flat Panel Retrofit Kits

Espen Technology launched a new family of field-adjustable flat panel retrofit kits, for upgrading fluorescent troffers to the latest LED technology. The new 3-output selectable flat panel kits are part of the versaKIT family of LED retrofit kits, that also include switchable center-basket troffer kits and switchable



**Cree® J Series® 2835 3V G Class 0.2W LEDs are industry’s highest efficacy 2835 – up to 224 lm/W**

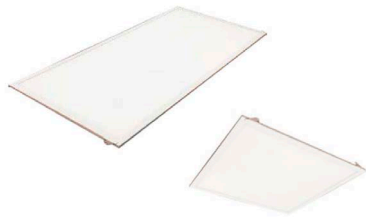
Cree’s J Series 2835 LEDs combine high efficacy and low power consumption in a reliable package. The J Series 2835 LEDs are optimized for applications where high efficacy and smooth appearance are critical, such as high bay, troffers, and panel lights. Available in 2200-6500 K with 70-95 CRI color options in an industry-standard 2.8x3.5 mm package.

[www.cree.com/led-components/products/j2835/jseries-2835?WT.mc\\_id=crx1972](http://www.cree.com/led-components/products/j2835/jseries-2835?WT.mc_id=crx1972)



commercial downlight kits. Each flat panel retrofit kit has a 3-position dip switch that enables installers to easily select a wattage and light output, for the kit, at the time of installation.

According to John Clancy, SVP of Sales & Marketing at Espen, "The new 3-output flat panel retrofit kits can reduce inventory stocking requirements for both electrical distributors and contractors." Clancy added, "Retrofitting the existing troffer housing with Espen’s pre-assembled kit takes only a minute to install, saving labor costs, and the entire retrofit is done from below the ceiling." The



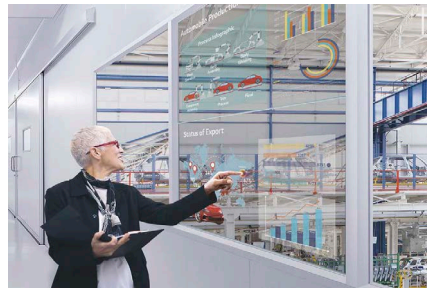
Wattage and max. lumen output of Espen Tech’s new flat panel retrofit kits can be set on location when installing them to accommodate the desired light output

new flat panel retrofit kits have an advanced low-profile, edge-lit design. The kit provides all the components needed to perform the change out quickly and efficiently, enabling system upgrades without disturbing the ceiling. The LED kits are completely assembled within their frame. The new switchable output flat panel kits are offered in 3000 K, 3500 K, 4000 K, and 5000 K CCTs, as well as 2X2 and 2X4 sizes. Additional features include: 0-10 V dimming driver, DLC listing, UL listing, and a 5 year warranty. ■

**LG’s Revolutionary Transparent OLED Touch Signage Display Creates AR Effect**

The new release from LG updates the popular Transparent OLED display that generated so much excitement during its rollout. With Transparent OLED Touch Signage, LG has

made futuristic technology available to businesses today. The LG solution, more



The future is today – LG Electronics’ new transparent OLED touch signage displays create a look and feel of 22nd century science-fiction movies

commonly called the Transparent OLED Touch, superimposes vividly colored images and text in high definition on whatever stands behind the screen, just as its predecessor does. Its revolutionary new facet, however, is its touchscreen capability. The Transparent OLED Touch stuns in its transparency, touch capability, durability and design.

**Transparency:**

The first building block to the striking effect of the Transparent OLED Touch is its unprecedented transparency: 33%, compared to the 10% of existing transparent LCD solutions. Because of the unique qualities of OLED technology, there’s no backlight or artificial light needed. The vivid colors are created by self-lighting pixels, ensuring a high-quality picture through which the object is clearly visible. From the moment it hit the market, the Transparent OLED has been popular in fashion retail, cafes and broadcast entertainment. The ability to superimpose lux images or clear information on whatever stands behind the screen has almost infinite uses.

**Touchscreen:**

What makes this solution extraordinary, however, is its ability to function as a touchscreen. A viewer can choose an option and the image on the screen can adapt. The rapid responsiveness is due to the P-Cap touch sensor film that’s layered into the display. The P-Cap touch sensor film allows for a much faster response than the IR type favored by other touchscreens. The structure also allows the display paper-thin transparency.

**Multiple uses:**

There are many ways to use this technology. One particularly well-received installation is the car configurator, in which the Transparent OLED Touch is placed before a video wall that shows a new car. The potential viewer uses a touchscreen menu to make changes to the car, customizing it before their eyes. Museums and exhibitions are also excited for the way the Transparent OLED Touch can serve as an enhancement, offering guests additional context as part of the viewing experience. On the opposite end of the spectrum, control rooms and executive offices make excellent use of the multilayered images and in-screen controls. R&D centers use those same abilities to forward their experiments.

**Durability and design:**

The Transparent OLED Touch is set apart from other products by its beauty and durability. The frame lets light pass through the space, as it looks like a pane of glass on a stand. Its slim design makes it feel weightless. Its tempered glass, meanwhile, makes the Transparent OLED Touch much stronger than its LCD counterparts.

The Transparent OLED Touch Signage from LG is a futuristic tool with applications in every sector. The only limit to its use is the imagination. ■

**LSI Industries Launches Multi-Setting LED Lensed Troffer**

LSI Industries has introduced a new, multi-setting LED lensed troffer to its OPT series of recessed luminaires. This high-efficiency product gives customers the ability to adjust the fixture’s color temperature and wattage – allowing them to customize the illumination in different areas of their facilities. The product’s flexibility makes it ideal for office buildings, health care facilities, retail settings and numerous other indoor applications.

"Our multi-setting troffers help us provide more lumen packages and value to our customers," said Mike Prachar, Chief Marketing Officer of LSI Industries. "With fluorescent luminaires getting phased out of the marketplace, our LED troffers are a

superior option for both facility upgrades and new construction projects.”

While other troffers may include settings to manipulate either color temperature or wattage, LSI's new multi-setting OPT luminaire gives customers the ability to adjust both. Customers can select up to three different options for both color temperature and wattage, giving them a total of nine different light settings from a single fixture. This gives employers significant flexibility to enhance individual work areas, increase employee safety and conserve energy. LSI's new



**LSI Industries' OPT series multi-setting troffers promise more lumen packages and value for customers**

multi-setting LED troffers feature durable, impact resistant lenses that eliminate bright spots and create comfortable, visually-appealing spaces. They are easy to install and available in standard 2x2 and 2x4 sizes. ■

## WAGO Introduces IPx8 Protected Gelbox

Condensation, heavy precipitation, powerful water jets: When moisture meets electricity, a short circuit can happen quickly. However, casting compound has proven itself as reliable protection. With Gelbox, WAGO clears a path to reliably achieving IPx8 levels of moisture protection in an easier and faster way.

### Open the Box, Insert the Connector, Close the Box

“Ready for instant deployment, re-accessible and suitable for unlimited storage – these benefits distinguish the WAGO Gelbox when it comes to protecting WAGO Splicing Connectors from moisture and humidity, such as that found outdoors,” summarizes WAGO Product Manager Sebastian Heemeier. Installation is fast and easy, “Simply open the box, insert the connectors, close the box,” he explains.

### Cellpack-Quality Gel – Silicone- and Label-free

The polyurethane gel used is silicone-free. “This makes the WAGO Gelbox ready to use in any branch of industry – even those where varnishes, paints and other sensitive products are used,” explains Heemeier. In addition, the gel has already reacted and is therefore

label-free. It is available in six sizes, can be used in a wide variety of low- and extra-low voltage applications and is compatible with both WAGO's 221 Series COMPACT Splicing Connectors and 2273 Series COMPACT PUSH WIRE® Connectors. WAGO, the



**The WAGO Gelbox provides splicing connectors with IPx8 levels of moisture protection**

Minden-based interconnection technology specialist, co-developed the Gelbox with Cellpack – the leading experts in moisture protection. “In the field of casting compound, Cellpack represents the pinnacle of quality, just as does WAGO does in the field of interconnection technology.” “Therefore, we are pleased that we were able to win this well-known manufacturer as a development partner,” says WAGO Product Manager Sebastian Heemeier. ■

## Instrument Systems: New Products for L+B

Instrument Systems was prepared to feature two new respectively optimized solutions for two different tasks at Light + Building, which has been postponed to September 27th - October 2nd. Instrument Systems has modified its proven TOP 200 telescopic optical probe to satisfy the requirements of the new IEC TR 62778 technical report. Furthermore, Instrument Systems launches traceable calibration UV-LEDs with extremely low measurement uncertainty.

### Reliable Measurement Solutions for BLH Testing to IEC TR 62778

The newly developed Technical Report IEC TR 62778 on photobiological safety prescribes practical methods for investigating the blue light hazard of LED light sources in general lighting. On this basis, Instrument Systems has modified its proven TOP 200 telescopic optical probe in satisfaction of the new measurement requirements while maintaining a high level of user comfort. In conjunction with a spectroradiometer, the adapted TOP 150-BLH reliably determines the blue light hazard by an explicitly defined weighting function in the SpecWin Pro analysis software. Compared to previous measurement solutions, the TOP 150-BLH is a fast and attractively priced alternative.

The rapidly increasing significance of modern solid-state lighting technology in our daily

environment poses important safety aspects with regard to photobiological safety and blue light hazard. The current international standard IEC 62471 contains the appropriate guidelines for the evaluation of lamps and lamp systems. Because it places extremely strict requirements on measuring equipment and procedures, supplementary practical evaluation methods have been introduced with Technical Report IEC TR 62778.

On this basis, Instrument Systems has developed a fast and practical measuring system for the evaluation of LEDs in excess of 360 nm. The new TOP 150-BLH telescopic optical probe is based on the proven TOP 200 telescopic optical probe, although it has only one aperture with a diameter of 7 mm. The aperture is positioned at the same height as the objective lens and corresponds to the reference level. A measuring spot over 2.2 mm is set via an internal aperture for test objects at a distance of 200 mm. This can be easily positioned by means of an internal alignment camera. A direct spectral radiance



**Instrument System's highlights for the postponed L+B: Measurement setup consisting of the TOP 150-BLH telescopic optical probe and the CAS 140D spectroradiometer for determining BLH hazard**

measurement can be made in conjunction with a calibrated CAS 140 D spectroradiometer and the accompanying SpecWin Pro analysis software. For effective evaluation of the blue light hazard the IEC 62471 standard prescribes a weighting factor by which the spectral measurement data must be multiplied. This function covers the wavelength range between 300 and 700 nm and has a maximum of 435 to 440 nm. In this range, blue light can cause photochemical damage to the retina. Independently of the radiation density LB and the calculated maximum exposure time  $t_{max}$  measured with the blue light hazard function, the analysis software classifies the light sources according to the four risk groups specified by the standard. Due to the simple measurement set-up, rapid and long-term stable measurements are also possible in production applications.

### Precise Radiation Measurement in the UV Range

Calibration UV-LEDs of the Instrument Systems ACS series are extremely stable UV



sources on LED basis that are traceable to radiant flux. They exhibit an extremely low measurement uncertainty (k=2) of only 4.5% (UVC), 3.5% (UVB) and 2% (UVA) and are available for typical peak wavelengths 280 nm (ACS-570-24), 305 nm (ACS570-26), and 365 nm (ACS-570-28). Calibration UV-LEDs are used for absolute calibration and monitoring of UV measuring equipment.

Instrument Systems was the first company in the world to develop calibration UV-LEDs that can be traceably calibrated to radiant flux. The calibration UV-LEDs of the ACS series are available for the typically peak wavelengths of 280 nm (UVC), 305 nm (UVB) and 365 nm (UVA). The proven ACS series on LED basis now covers the complete visible and infrared to deep into the ultraviolet range. The traceability of the radiant flux is achieved due to the highly precise calibration of the spectrometer optical probes to the irradiance and integrative measurement with the goniophotometer. The extremely low measurement uncertainty (k=2) of only 4.5% (UVC), 3.5% (UVB) and 2% (UVA) is comparatively low, as in the metrologically unproblematic visible range. Calibration UV-LEDs can be used for monitoring and absolute calibration of the special UV measuring equipment such as integrating spheres of the ISP-UV series. ■

## Lumitronix Designed New Flexible LED Strips for L+B

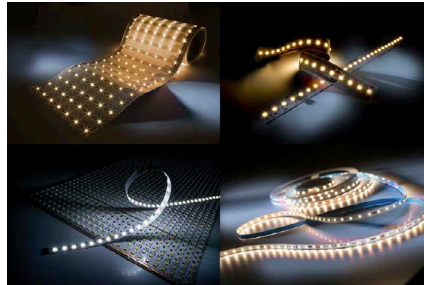
Lumitronix had several product innovations prepared for the postponed Light + Building. Amongst these products are flexible LED strips for different applications. Z-Flex 280x20 based on the widespread Zhaga standard of modules with a length of one foot and therefore compatible with many linear luminaire types. LumiFlex560 Professional TW has been assembled in the reel-to-reel process on the new in-house production line which allows an individual assembly of the desired dimensions. LumiFlex350 Professional and offers luminaire manufacturers new possibilities, primarily due to its processing and is equipped with an integrated linear control. As a highlight – first samples were already presented at LpS 2019 - Paper-Flex uses paper as base material and is manufactured by a proprietary plasma metallization technology.

### Paper-Flex – Flexible LED modules using paper as a base material on rolls of up to 50 meters

Paper-Flex, a flexible LED module made of paper, can be assembled on the new in-house production line in a reel-to-reel process. The state-of-the-art production line is capable of processing flexible substrates of any kind in almost endless lengths - including paper.

The standard version of Paper-Flex has a length of 24.85 meters and a width of 35

centimeters. It consists of a total of 497 LED strands, each five centimeters wide. Each LED strand has seven LEDs, which together produce a luminous flux of 55 lumens. In total, the complete roll of Paper-Flex provides a luminous flux of 27335 lumens. As the Paper-Flex modules are divided into separate strands, they can be individually assembled in different lengths according to customer requirements. Currently, rolls of up to 50 meters are possible. The LEDs installed on the



Lumitronix's four flexible LED module highlights prepared for L+B are from top left to bottom right Paper-Flex, Z-Flex 280x20, LumiFlex560 Professional TW, and LumiFlex350 Professional

Paper-Flex module have a color temperature of 2700 K and a CRI of over 80. In addition, individual configurations of Paper-Flex with regard to the LED types in terms of colour temperature, CRI and efficiency are available on request.

Advantages of Paper Flex compared to conventional base materials:

"Compared to rigid boards, which form the basis of many LED module types, one of the advantages of Paper-Flex is the simplification of processing. The paper modules to be adhered can be installed in a time-saving manner and are also touch-proof due to the low voltage of 24 V," Christian Hoffmann, CEO of Lumitronix, reports.

In addition, the extremely low weight - one strand weighs about 2 grams - and the roll shape ensure that storage and transport costs are significantly minimized. Moreover, the paper substrate is ultra-flat (approx. 0.8 mm after assembly) and thus more than suitable for large-area applications where a low installation height is required. The diffusion openness of Paper-Flex is a decisive factor in ensuring that the paper modules can be used as wallpaper. Due to the breathability of the paper there is no danger of moisture accumulation.

"Paper-Flex is a future-oriented product that uses paper as a sustainable and environmentally friendly basis. This makes the paper module a novelty in the industry, enabling it to be used in a wide range of applications," Hoffmann continues.

Possible applications and areas of use for the Paper-Flex LED modules include: wallpapers, very large advertising surfaces, decorations

and backlighting of furniture, trade fair construction, luminaire manufacture and basically all large-area applications with radii and curved shapes.

### Simplification in processing and cost reduction with Z-Flex 280x20

Christian Hoffmann, CEO of Lumitronix, is aware of the advantages of the Z-Flex 280x20: "Unlike rigid modules, which have to be fixed in large numbers with screws depending on the nature of the luminaire, the Z-Flex LED strips can be glued into the body in one piece. Another advantage over modules based on rigid boards is the wiring. The Z-Flex modules can be operated up to a maximum length of 1.4 metres with one feed."

The 280 x 20 mm Z-Flex modules are produced by Lumitronix on the new Flex production line in lengths of 5.6 and 56 m using the reel-to-reel process. "This results in considerable savings for companies in the lighting industry, especially with regard to such costs as warehousing and transport. The roll form also proves to be helpful in terms of reducing the time required to install the Flex modules, as rigid modules are usually individually wrapped in ESD foil and are therefore very time-consuming to install." Hoffmann continues.

Available in SELV and non-SELV versions: The flexible modules are available in SELV and Non SELV versions. The SELV version offers the decisive advantage that the modules can be mechanically separated without the risk of flashovers due to the low operating voltage, thus making them safe to touch. The Non SELV modules are not electrically plated through over their entire length due to the higher voltage, thus ensuring a sufficient safety distance to the conductor tracks even after disconnection.

### LumiFlex560 Professional TW – flexible LED strips with innovative 2-in-1 tunable white LEDs

The LumiFlex560 Professional TW is a flexible LED strip that has been assembled in the reel-to-reel process on the new in-house production line, which is capable of processing flexible substrates of any kind in almost endless lengths. Subsequently, an individual assembly of the desired dimensions is possible. The standard version of the LumiFlex560 Professional TW has 560 LEDs over a length of 5 meters.

The special feature of the new flex strips lies in the LEDs installed. "We rely on the groundbreaking NF2W757G-MT 2-in-1 Tunable White LEDs from Nichia," says Lumitronix CEO Christian Hoffmann. These are the world's first LEDs to combine a color temperature range of 2700 to 6500 K under one phosphor layer. "This results in a much more homogeneous light image and finer color matching and mixing, since all color temperatures are under one emitting surface.

In addition, a higher color rendering index (CRI 90) is possible.” Hoffmann continues. Furthermore, the 2-in-1 form creates more options regarding optics and greater scope and creativity when designing new luminaire designs.

#### LumiFlex350 Professional - produced in a reel-to-reel process

“The new LumiFlex350 Professional LED strips are the first flexible LED strips from Lumitronix that have been produced in a reel-to-reel process on the company’s own new Flex production line.” emphasizes CEO Christian Hoffmann. Equipped with 350 LEDs, the LED flex strips have a standard length of 5 metres, are available in colour temperatures of 2700 K, 3000 K, 4000 K and 6500 K and have a long service life and high efficiency. An integrated linear control also ensures that the brightness remains constant throughout. The strips can easily be cut every 100 mm with scissors, thus increasing flexibility in terms of applicability.

Hoffmann continues: “The Lumitronix production line allows processing beyond the standard length of 5000 mm up to 50 meters in one piece. Individual assembly following placement is also possible.” ■

### SMART & IOT

## Scaling Up Wireless Lighting Controls

Located in the picturesque city of Red Deer, Canada, Westerner Park is Central Alberta’s largest trade show, agriculture, entertainment and sports facility. For more than 125 years, it has been a destination of choice for locals gathering to celebrate all kinds of community events. Just recently, it has also become home to some of the biggest Bluetooth mesh lighting control networks. Each year, Westerner Park hosts approximately 1,500 events and 1.5 million visitors. It is a 320-acre complex with multiple venues tailored to meet the diverse needs of the local community. From weddings and banquets to hockey games and agricultural shows, they are ready to host any event you can possibly imagine. Quality lighting is an important part of the experience offered by Westerner Park, and the managers decided that the time had come for a major lighting retrofit program. The brief was to address recurring maintenance issues with the existing T5 fixtures, as well as to increase the light level and reduce energy consumption.

The first stage of the retrofit covered five facilities totalling 120,000 sq feet/11,150 m<sup>2</sup>.

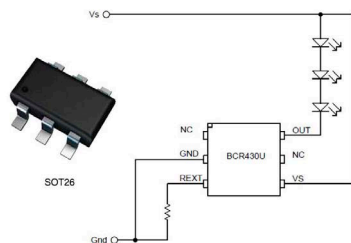
First, the existing T5 fixtures were replaced with Eiko LED high bay luminaires. Once installed, the luminaires were divided into groups, with each group controlled by a Bluetooth SIG-qualified Fulham EliteControl

fixture controller. In each of the pavilions, a single EnOcean wireless energy harvesting switch was deployed to allow for controlling all of the luminaires at once. 1st Star Electric Systems LTD took care of the commissioning process, using Fulham’s eliteBlue app to set up the entire installation. Developed in cooperation with Silvar as the company’s technology partner, the eliteBlue app allows for easy and time-efficient commissioning, customising, and monitoring of Bluetooth mesh luminaires.

The first stage of the lighting overhaul was completed quickly, and the flawless performance of a wireless control system proved that choosing Bluetooth mesh was a great choice. This encouraged Westerner Park to immediately launch preparations for another stage of the project. As part of it, fluorescent fixtures will be replaced in all of the remaining pavilions. This stage will also cover all the exterior area lights. Like previously, the lighting control system will be entirely wireless and based on the globally interoperable Bluetooth mesh standard. This allows Westerner Park to minimise the cost and disruption caused by the retrofit. ■

## Diodes’ Ultra-Low Dropout Linear LED Driver to Extend Lighting Strips

Diodes Incorporated announced the BCR430UW6 linear LED driver with ultra-low dropout voltage and constant current regulation between 5 mA and 100 mA. This combination allows more LEDs to be driven from a low supply voltage, making the BCR430UW6 suitable for applications that require multiple LEDs to operate together, such as signage illumination and architectural lighting for commercial and retail installations. The ultra-low dropout voltage of 115 mV and



Diodes’ BCR430UW6 linear LED driver offers ultra-low dropout voltage of 115 mV and low operating current of just 285  $\mu$ A, which especially has benefits in signage and architectural illumination

low operating current of just 285  $\mu$ A provides a greater level of system efficiency and scope to drive more LEDs per string reliably. These factors are particularly important in applications where the characteristics of the

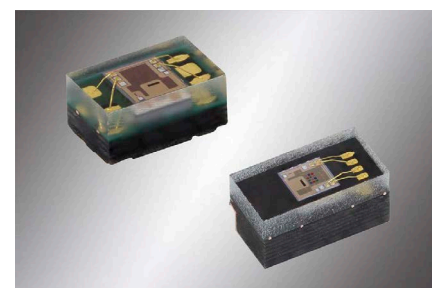
lighting are essential to the user experience, such as signage and architectural illumination.

The device requires no external power transistors or capacitors, reducing the overall BoM cost and increasing system stability. Long-term reliability is also improved through the robust design, which is tolerant to overvoltage levels resulting from faults in the LEDs or supply transients. Integrated thermal protection limits the output current in the event of high operating temperatures, avoiding operational failure and maximizing the working lifetime of the LEDs.

With an adjustable output current level between 5 mA and 100 mA, the BCR430UW6 can provide greater flexibility, allowing a single design to be used to drive various LED configurations. The output is highly stable, held at  $\pm 5\%$  across temperature variations and supply voltage fluctuations. This stability delivers a uniform output lighting level under all operating conditions. Other advanced features include PWM-based dimming, an operating voltage range of 5 V to 42 V, and support for parallel operation to further increase the regulated output current. ■

## Vishay Launches Integrated RGBC-IR Sensors With I<sup>2</sup>C Interface in Low Profile Packages

Vishay Intertechnology, Inc. broadens its optoelectronics portfolio with new RGBC-IR sensors for applications such as automatic white balancing and color cast correction in digital cameras; automatic LCD backlight adjustment; and active monitoring of LED color output for IoT and smart lighting. The new VEML3328 (top-looking) and VEML3328SL (side-looking) sensors offer better linearity and higher sensitivity compared to previous generation devices, as well as new features including an infrared (IR) channel. The



Vishay’s new sensors not just sense red, green, blue, clear, and IR light but calculate CCT, sense ambient light, and transfer data using an I<sup>2</sup>C (SMBus compatible) interface protocol

sensors released today sense red, green, blue, clear, and IR light by incorporating photodiodes, amplifiers, and analog / digital

circuits into a single CMOS chip. With the ability to calculate color temperature and sense ambient light, the devices offer a compact solution for adjusting backlighting in consumer electronics and notebook computers. They can also help to differentiate indoor from outdoor lighting environments to ensure that displays maintain consistent true color and ideal brightness levels based on the current environment lighting conditions.

In addition to digital camera and TV applications, the VEML3328 and VEML3328SL will also be used in various industrial and consumer applications where their excellent temperature compensation capability will keep the sensors' output stable under changing temperatures.

The sensors' built-in ambient light photodiode offers extremely high sensitivity, allowing the devices to operate in applications with dark lens designs. A programmable analog gain and integration time function, as well as the additional IR channel, allow designers to tailor the VEML3328 and VEML3328SL to their applications.

The sensors' functions are easily operated via the simple and power-efficient I<sup>2</sup>C (SMBus compatible) interface protocol. The devices feature a low operating voltage range of 2.6 V to 3.6 V to help prolong battery life in handheld and portable systems. ■

## New Casambi-Enabled LED Drivers from Harvard

Casambi provides a modern wireless lighting control system based on Bluetooth Low Energy, the only low power wireless technology in all modern smart phones, tablets and even smart watches. Working with Holders, Harvard Power Systems have integrated a Casambi node into its full range of CoolLED PRO CLi Series LED drivers whilst retaining all their high specification features in their ultra-compact size – the drivers are half the size of other lower technology drivers. The key advantage of the smaller case size of Harvard LED drivers is that they fit through relatively small 40 mm or 56 mm holes in the ceiling, making them ideal as a fast-fit solution for use with LED downlights.

The CoolLED PRO CLi Series of Casambi-enabled LED drivers are available in 15W, 25W and 40W versions and are programmable from 100 to 1400mA. Specification rich, the CLi Series LED drivers provide smooth flicker-free dimming down to 0.1%, particularly desirable for aesthetic & display applications, whilst also allowing smooth Soft-On & Soft-Off functionality, offering enhanced comfort for interior and architectural applications.

Mark Needham, Managing Director of Harvard

Power Systems comments, "We are delighted to have worked in partnership with Holders on this range of Casambi-enabled drivers particularly because we know that customers will be assured of the best possible customer service in the way of technical support and advice to achieve the best solutions for their lighting schemes."

Mat Hanson, Sales Director for Holders, adds, "Holders are delighted to partner with Harvard Power Systems in promoting their market leading, integrated Casambi LED drivers. This great development marries best-in-class Bluetooth technology, in the form of Casambi, with the deepest dimming, flicker-free technology from Harvard. Bringing together these two exciting technologies, the Casambi-enabled Harvard CLi15 and CLi40 LED drivers are ideal for the demanding specifications of residential, architectural, hospitality and retail projects where exciting dynamic control of LED lighting is required, without compromising the quality of light being delivered." Harvard's CLi Series LED drivers



In a partnership with Holders, UK distributor for Casambi, Harvard Power Systems is launching a full range of their high specification CLi Series LED drivers with built-in Casambi wireless communications capabilities

including 0–10V, DALI dimmable and now the fully embedded CASAMBI variants, all come with a comprehensive five-year warranty. All are SELV compliant and will operate with a lower voltage supply, compatible with emergency applications. Extended life tests demonstrate high reliability and low audible noise below 20dBA yet despite their high specification, these new LED drivers are competitively priced to meet market demand. ■

## eldoLED Releases Industry's First DiiA Certified DALI-2 DT8 Tc Drivers

Acuity Brands, Inc. announced that eldoLED®, a world leader in designing and manufacturing intelligent drive solutions for LED-based lighting systems, has received the first Digital Illumination Interface Alliance (DiiA) certification for DALI Device Type 8 (DT8) color type Tc drivers. Courtesy of Forum Groningen: featuring over 1000 tunable white luminaires

using eldoLED's DALI-2 DT8 compliant technology. Precise calibration of color and intensity at the driver level makes all the difference in a tunable white installation. Drivers using the DT8 protocol, also known as



Over 1000 tunable white luminaires using eldoLED's DALI-2 DT8 compliant technology for precise calibration of color and intensity (Courtesy: Forum Groningen). - eldoLED's DUALdrive LED drivers are the industry's first to receive DT8 certification

DALI 209, can use a single DALI short address to control two or more outputs. This can yield cost, space and manpower savings for RGB/W color changing and tunable white driver technology (DT8) within one fixture. This technology allows the end user to change the light color, color temperature and intensity of LEDs in a room or across a lighting system.

"eldoLED is the first in the industry to receive a DiiA certification for these types of drivers, marking a significant technology advancement for using DALI to specify and control color in LED modules," said Gilles Abrahamse, Acuity Brands Lighting Vice President of Digital Luminaire Components.

*"Reducing the number of addresses simplifies design and commissioning."*

CHAD STALKER, VICE PRESIDENT GLOBAL OEM MARKETING AND SALES

"DT8 certification is the culmination of eldoLED's latest effort to elevate color science and is a significant step forward in our quest to bring digital solutions to market, simplify solution development, and drive the quality of light in LED systems," said Chad.

Use of the DT8 driver technology is certified in the DUALdrive 562 and 20W LED driver models from eldoLED. Other DUALdrive products and certain LINEARdrive products are currently in the DT8 certification process. eldoLED drivers are interoperable with many LED systems. ■

## EuControls Introduces Its Zigbee Compatible Ceiling Mount Multi-Sensor 810-PLT-DZB

EuControls is excited to announce the addition of a compact ceiling mount multi-sensor/controller to its growing wireless lighting controls product portfolio. The S810-PLT-DZB is a unique Zigbee compatible energy management device aimed at new and retrofit indoor lighting projects that require occupancy, light, and temperature sensing, in addition to fixture-level lighting control. 12VDC-powered with a 0–10V dimming interface, this relay-less sensor is ideal for sensor-ready Dim-to-Zero/Off LED drivers equipped with auxiliary power. The



EuControls' S810-PLT-DZB is a unique Zigbee compatible energy management device

S810-PLT-DZB has a low profile, designed for installation through a standard drop ceiling tile or in the bottom of a light fixture body, providing a 13' detection radius at a 10' mount height. It uses PIR (passive infrared) sensing technology to detect motion in its coverage area, and can automatically dim or turn off local or networked lights when persons have left the area, reducing energy usage. A built-in photodiode allows for daylight harvesting operation and additional energy savings, while a temperature sensor enables HVAC applications for increasing occupant comfort. ■

## Compact Energy Meter

Consumers and governments are pushing for greater sustainability, with energy consumption in their crosshairs. And businesses are learning that to optimize energy consumption, they must first measure it. WAGO's all-new energy meters satisfy this need while providing tremendous advantages for both industrial and building applications. The new energy meters have an incredibly compact design for installation flexibility. The devices for direct measurement have a width of just 72 mm; versions for current transformers are even slimmer at only 35 mm, preserving valuable control cabinet space. WAGO's energy meters not only record the values for reactive and active energy, but also



WAGO's new energy meters perfectly measure energy consumption in a wide range of applications

provide information on mains frequency, current, voltage and power for all phases.

The devices are connected via lever-actuated Push-in CAGE CLAMP® technology. This benefit dramatically simplifies and expedites installation. Similarly, configuration is quick, easy and performed via touch-sensitive controls. Alternatively, the energy meters can also be configured via an app – communication occurs via Bluetooth®.

WAGO's meters are equipped with both an M-Bus and a Modbus® interface for transmitting measured values. In addition, two SO interfaces with an adjustable pulse rate are available for both energy directions. This flexibility makes the devices true communication professionals and thus creates a high degree of transparency in energy consumption measurement. While on-site, users can conveniently see the energy quality characteristics for all phases on the meters' large-format displays.

Energy transparency is an invaluable business tool. And it's particularly indispensable to applications such as charging infrastructure, order-related production or distributed properties. Each of these scenarios shares the same challenge: increasing energy efficiency and passing on the costs to the individual consumers. WAGO's new generation of energy meters with lever-actuated Push-in CAGE CLAMP® technology helps master these challenges. ■

## Lumitronix Announces MiniController Casambi Classic and LED Modules for Ledil's Dark Light Optics Daisy-Mini

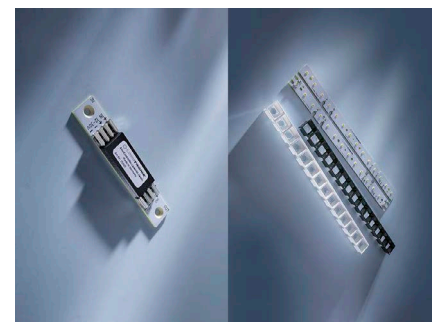
Among the new products prepared for Light + Building 2020 by Lumitronix are the MiniController Casambi Classic and the MiniDaisy LED modules. The control unit for LED modules with Tunable White technology are extremely compact and can be conveniently operated via smartphone or tablet using the Casambi App, while the MiniDaisy LED modules which were designed

in close cooperation with the Finnish optics manufacturer Ledil are compatible with the new Daisy-Mini linear optics and are intended for use in office or workplace luminaires.

### MiniController Casambi Classic for smart tunable white operation

The control unit for LED modules with Tunable White technology is just 8 cm long and 1.4 cm wide. Christian Hoffmann, CEO of the Swabian company, summarizes the features of the tiny control unit:

"Two channels can be used to control either one Tunable White module or two monochrome modules with a constant voltage of 12 to 24 V. The controller supports up to 3.5 A per channel. The standby power is approx. 150 mW at a voltage of 24 V. With the help of the Bluetooth-based app from the Finnish technology company Casambi, which is available free of charge for iOS and Android devices, the brightness and color temperature of the LED modules connected to the MiniController can be individually controlled. A Dim2Warm mode can also be implemented. Furthermore, the app can be used to determine whether the last selected brightness and color temperature values should be retained after a voltage interruption." The very small dimensions of the



Lumitronix's new MiniController Casambi Classic (left) for tunable white applications is just 8 cm long and 1.4 cm wide. The MiniDaisy LED modules (right)

MiniController Casambi Classic from Lumitronix make it ideal for an integration into a wide range of luminaire types. Moreover, the prepared drill holes with countersink for M3 screws make an installation easier.

### LED modules for Ledil's dark light optics Daisy-Mini

Daisy-Mini is an extension of Ledil's Dark Light concept, which aims to provide unobtrusive and discreet lighting that creates a more natural atmosphere. Only 21 mm wide, it offers a linear solution for luminaires and is composed of a seamless and glare-free cover combined with 14 effective lenses. The plastic covers are available in black and white in a matt and glossy version and can be conveniently attached to the rod lenses with a click.



### UV-LED Calibration Standards – ACS Series

Calibration UV-LEDs of the Instrument Systems ACS series are extremely stable UV sources on LED basis that are traceable to radiant flux. They exhibit an extremely low measurement uncertainty ( $k=2$ ) of only 4.5% (UVC), 3.5% (UVB) and 2% (UVA) and are available for typical peak wavelengths 280 nm, 305 nm, and 365 nm. Calibration UV-LEDs are used for absolute calibration of UV measuring equipment.

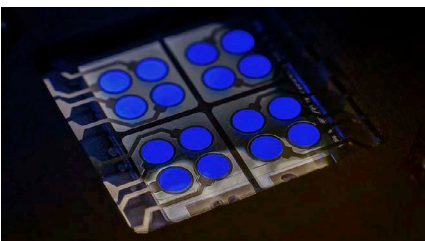
[www.instrumentsystems.com](http://www.instrumentsystems.com)



The modules from Lumitronix were produced in two versions. The first is equipped with 14 neutral white Nichia LEDs of the 757 series over a length of 279.65 mm. The second version contains 14 of the new 2 in 1 Tunable White LEDs from Nichia over the same length. This new type of light-emitting diode is the first in the world to combine a colour temperature range of 2700 to 6500 Kelvin under one phosphor layer, thus enabling finer colour matching and mixing. In combination with the Daisy-Mini linear lenses, the LED modules from Lumitronix allow particularly filigree luminaire designs to be created in the field of office lighting. ■

### Cynora Introduces Fluorescent Blue Emitter that Gives OLEDs a Substantial Efficiency Boost

Cynora debuted its first commercial product, a fluorescent blue emitter that promises to significantly improve the efficiency of Organic Light Emitting Diode (OLED) displays used in mobile phones, laptops, TVs, and other applications. The company is an emerging OLED materials leader. The product, known as the cyBlueBooster™, employs an advanced molecular design and is >15 percent more efficient than comparative emitters. It can be easily integrated into existing OLED stacks and is available in multiple shades of blue for application customization. The product aims to help display manufacturers immediately harness untapped efficiencies in the emission layer of their OLED devices. The launch marks



cyBlueBooster - Cynora's Fluorescent Blue Emitter in an OLED device improves efficacy significantly (Picture: Dr. Harald Flügge, cynora GmbH)

Cynora's transition from cutting-edge research and development to commercialization. The new product is the first on a technology

roadmap that will later include green and blue emitters based on the company's proprietary and differentiated TADF materials platform.

The OLED market continues to grow with the technology driving an array of flexible, foldable and ultra-thin displays. To enable the novel form factors and achieve superior color points, low power consumption is a central imperative. Yet, while OLED technology is well in the mainstream, the OLED devices have still to reach peak efficiency. The emission layers determine the overall performance of the OLED stack and exert a strong influence on power consumption. Blue is the least efficient emitter. Consequently, the industry is focusing intensely on finding new ways to improve efficiency. Also, with next-generation displays like QD OLEDs using blue emitters only, the need for ultra-high-efficiency options is even more urgent.

Cynora developed the cyBlueBooster to address the high-efficiency imperative. Engineered using proprietary simulation techniques, the product delivers >15 percent higher efficiency over comparative solutions, while also improving the color point. It has a narrow emission spectrum (<30nm full-width at half maximum) which reduces harmful UV light and makes the viewing experience easier on the eye. The product can be seamlessly integrated into existing OLED devices with only minor adjustments to the stack. Depending on the application, customers can select a particular shade of blue to optimize their stack and further differentiate their OLED products.

*"This solution is a compelling alternative option for current-and-future-generation OLED displays."*

ADAM KABLANIAN, CEO CYNORA

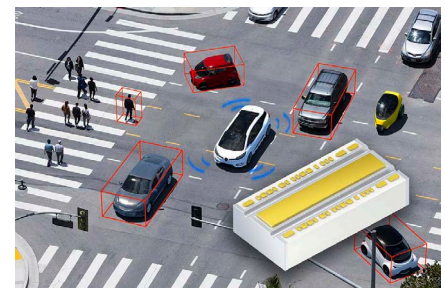
"We built the product in collaboration with OLED ecosystem partners, not just to drive better performance and efficiency advantages, but also with simplicity of integration in mind. It's the result of extensive materials research by our technologists and their keen knowledge of OLED efficiency gaps. We're pleased to mark this first commercial milestone. The

innovation continues as we work to refine our next products," said Mr. Kablanian. ■

### AUTOMOTIVE

### Osram Presents New Infrared Laser for Short-Range LiDAR Applications

How long do you think cars will be steered by a driver? For autonomous driving to become widespread, several legal and technological hurdles will have to be overcome in the upcoming years. Nevertheless, car manufacturers and mobility service providers are already working on their visions for driverless vehicles. The need for autonomous vehicles to more comprehensively and reliably detect their surroundings makes the number and arrangement of sensors, such as LiDAR (Light Detection And Ranging), more critical. As the market leader for LiDAR lasers, Osram Opto Semiconductors plays a central role in the realization of these applications. With the SPL DP90 3, the semiconductor expert is expanding its portfolio with a component that has been specially developed for high-resolution, near-field detection in LiDAR systems. There is now a broad consensus



With SPL DP90 3, Osram adds a 65 Watt laser to its LiDAR photonics portfolio and brings autonomous driving one step closer

that only a sensor fusion of LiDAR, radar and camera systems can provide the necessary security for fully autonomous driving. Each of these technologies has advantages and disadvantages depending on the respective scenario, but overall, the better they are coordinated - the safer the vehicle moves through traffic. For example, LiDAR systems are strong in generating high-resolution 3D

information in real time. Long-range LiDAR is used to detect objects up to approximately 250 meters away. The immediate surroundings of the car must also be reliably captured by short- or mid-range LiDAR, which covers a distance up to approximately 90 meters from the vehicle. Short- or mid-range LiDAR covers classic traffic situations such as passing cars on highways or driving in urban traffic.

*“Groundbreaking decisions are currently being made about which components will be used in which systems for autonomous driving.”*

JÖRG STRAUSS, GENERAL MANAGER AND VICE PRESIDENT FOR VISUALIZATION & LASER AT OSRAM OPTO SEMICONDUCTORS

With SPL DP90 3, Osram is presenting a new single-channel pulsed laser that features improved beam quality and particularly compact dimensions. Thanks to its space-saving footprint of just 0.3x0.6 mm, system manufacturers can create extremely compact designs. An efficiency of around 30 percent helps reduce the overall cost of the system during operation. With an optical output of 65 Watts at 20 A, the component not only has an absolute unique selling point but is also ideally suited for capturing the immediate vehicle surroundings, ensuring high-resolution images for subsequent systems.

“Thanks to our many years of experience in the development and production of special infrared lasers for LiDAR systems, we enjoy a high level of trust among our customers. The superior quality of our products has further consolidated our strong market position in this area. With the SPL DP90 3, our customers have another choice to help realize their visions for autonomous driving.” ■

## Osram's New Oslon LED Enables Ultra-Slim Designs for Headlights

Light is the new chrome for cars. In recent years, technological progress in car lighting has led to light becoming an essential design element in modern cars. Smaller and brighter light sources are leading to more compact and versatile headlamps. The powerful Osram Oslon Boost HM pays tribute to this trend by enabling ultra-slim headlamp designs in vehicles.

In addition to numerous features such as

adaptive front lighting, often called bend lighting or matrix lighting, the miniaturization of this component plays a particularly important role. With the Oslon Boost HM, Osram developers have succeeded in achieving an outstanding brightness of 415 lm at 1.5 A with a very small chip area of just 0.5 mm<sup>2</sup>. The



Osram's Oslon Boost HM delivers outstanding brightness values with compact dimensions for ultra-slim headlight designs

package of the LED is also particularly compact at 1.9x1.5x0.73 mm, providing a finger-width front headlamp solution, without compromising light output. The luminance of 255 cd/mm<sup>2</sup> at 1.5 A is an absolute best-in-class performance value for this type of LED.

*“We include particularly high luminance levels to create ultra-slim headlamp designs.”*

FLORIAN FINK, MARKETING MANAGER FOR AUTOMOTIVE EXTERIOR AT OSRAM OPTO SEMICONDUCTORS

In addition to headlamps, the Oslon Boost HM can also be used in combination with other LEDs, to provide an additional high beam. Thanks to its outstanding luminance, the LED is also suitable for use in MEMS-based adaptive front lighting systems. Osram Opto Semiconductors was able to draw on its many years of expertise in package design to create this new product. ■

## ON Semiconductor Launches Automotive LED Drivers and Controllers for Advanced Vehicle Lighting

ON Semiconductor, driving energy efficient innovations, has launched a new family of four devices that facilitate the high levels of performance and innovative functionality that vehicle manufacturers and consumers now expect from automotive exterior and interior lighting. Aimed specifically at low power solid

state lighting, the new family comprises two LED drivers (NCV7683 and NCV7685) and two current controllers (NCV7691 and NCV7692).

In the pursuit of improved road safety, automakers are moving away from the simple 'on/off' operation to sophisticated systems that incorporate movement and variable intensity within rear combination lamps (RCLs), turn signals, fog lamps, and other externally modulated LED clusters to give clearer and highly visible warnings to other road users.

*“LED-based automotive lighting creates exciting opportunities for vehicle engineers to reinforce branding and identity.”*

JIM ALVERNAZ, AUTOMOTIVE PRODUCTS DIVISION AT ON SEMICONDUCTOR

The NCV7685 and NCV7683 integrate twelve and eight linear programmable current sources, respectively, enabling multiple strings of LEDs to be driven with up to 100 mA per channel. The devices provide an array of configurability options, including daisy-chaining, illumination level control, current regulation, sequencing functionality, and channel combination. The NCV7685 incorporates an 8-bit I2C interface with CRC8 error detection for individual output current adjustment via pulse width modulation (PWM), and for advanced diagnostics - including detection of an open LED string or under voltage condition – a dedicated diagnostic pin is also available. The NCV7685 may be powered with a DC-DC controller and/or LDO voltage regulator, depending upon specific design requirements. The NCV7691 provides



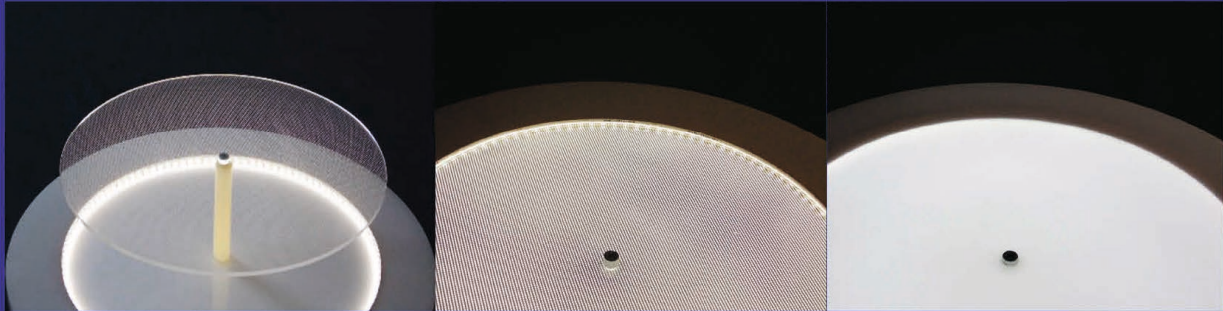
ON Semiconductor's new family of devices simplifies task of designing efficient and reliable lighting solutions with sophisticated functionality to enhance road safety

a regulated wide current range for driving LEDs in one or multiple strings, with only an external NPN bipolar transistor and a feedback resistor. The driver provides design flexibility to add additional single channels to multichannel systems, and supports a dimming function via its PWM input. The NCV7691 includes open

## Light guide for every area geometry

### LED is indispensable in today's world!

Sophisticated optical fiber technology helps to produce homogeneous light-emitting surface luminaires with Very high luminance from these spotlights. It helps to produce very thin LED lamps!



A light guide with perfect homogeneous illumination is useful for various areas, e.g. in the railway industry for various background lighting of signs, laboratory equipment for blood analysis, backlighting of images, various ceiling lighting, backlighting for the watch industry, etc.

[www.enz.ch](http://www.enz.ch)

string, short circuit, and thermal shutdown, ensuring safe and reliable operation of essential lighting. The derivative NCV7692 offers a faster response time and a reduced threshold for open load detection.

"With the performance and functionality now possible with LED lighting, and demanded by automakers and consumers alike, sophisticated lighting drivers and controllers are fundamental to help turn ideas into reality," said Jim Alvernaz. ■

### GL Optic Offers Fast and Reliable Measurements for Automotive Lighting

Nowadays car manufacturers are facing rapid strides in the development of automotive lighting meaning that the sole functionality of the lamps are no longer the major focus. Special attention is paid to new shapes, sizes and designs and the overall user-experience. These are key factors that need to be considered in order to be able to compete in increasingly faster growing markets. GL Optic introduces a new type A Goniophotometer, the GLG A 50-1800, to accommodate these requirements perfectly.

The main product focus for measurements in the automotive sector is on the new type A

Goniophotometer, the GLG A 50-1800, which is used to measure exterior lighting of vehicles. This new Gonio photometer system is suitable for the complete photometric characterization of automotive lamps in H and V axis coordinates and is therefore utilized for the exterior lighting of vehicles, such as headlight indicators or brake lights.

The system complies with the CIE 121-1996 and IESNA LM-75-01 standards that regulate photometric and colorimetric far-field measurement systems. In addition, it is in accordance with UN/ECE and SAE/FMVSS standards. The GLG A 50-1800



GL Optic offers a wide range of instruments that can be used to measure any kind of automotive lighting products in addition to the new type A Goniophotometer, the GLG A 50-1800

Goniophotometer is constructed for everyday use in research and development laboratories as well as in laboratories of product conformity

testing centers, where reliable and accurate data needs to be provided by a user-friendly goniophotometric system.

The goniophotometer is specifically designed for photometric testing of the luminous intensity distribution of automotive LEDs and other lamp types in H, V coordinates. With a fast photometer, it is possible to measure from distances > 3 m, 10 m and 25 m.

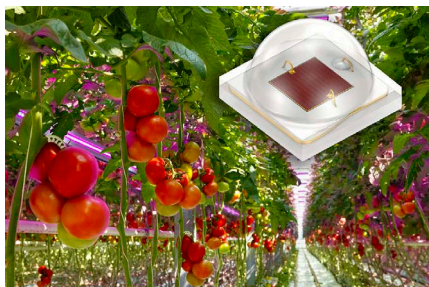
Combined with various spectrometers from GL Optic, for instance the GL SPECTIS 5.0 Touch or the GL PHOTOMETER 3.0 LS + Flicker, the scope of functions can be extended depending on the specific application and measurement task. The goniometer system is suitable for test samples with dimensions of up to 1800mm and a weight of up to 50 kg. ■

**HORTICULTURE**

### Osram Presents Most Efficient New Generation Oslon Square Hyper Red

The world population has been growing for many years. In particular, metropolitan areas are attracting more and more people. In places where farmland is limited and delivery must be quick, horticulture lighting offers a major advantage. With the help of

state-of-the-art lighting technology, it is possible to provide the exact light composition various plants need for ideal growth or to develop certain characteristics. Plants can be grown in a very space-saving manner and with considerably higher yields thanks to tailor-made lighting solutions. For greenhouse owners, energy footprint is essential to production. The new generation of Oslon Square Hyper Red contributes to improving efficiency far more effectively than comparable products currently available on the market. During dark season, many of us experience



Horticulture Lighting helps where natural daylight is not enough and Osram's new generation of Oslon Square Hyper Red is the most efficient LED for Horticulture lighting to date

the effects of not getting enough light. As soon as the days get shorter, we feel more

tired and exhausted. Plants are in a similar situation - when they don't get enough light, their photosynthesis doesn't work sufficiently.

*"Horticulture lighting is an absolute growth market."*

YONG SHENG CHEW, PRODUCT MANAGER AT OSRAM OPTO SEMICONDUCTORS

Plants predominantly need red (640 to 700 nm) and blue light (400 to 490 nm) for their growth. For example, red light promotes the production of biomass in plants. The new generation of the Oslon Square Hyper Red with a wavelength of 660 nm is the flagship product in Osram Opto Semiconductors' comprehensive Horticulture portfolio. In addition to the outstanding efficiency values, greenhouse operators benefit from a radiant flux of 1.030 mW at 73% WPE (wall-plug efficiency) and a photon flux of 5.7  $\mu\text{mol/s}$  at an efficacy of 4.0  $\mu\text{mol/J}$  at 700 mA. For applications with higher efficacy requirements, the LED provides 78% at a driving current of 350 mA and 80% at 250 mA with an efficiency of 4.6  $\mu\text{mol/J}$ . Besides the best-in-class efficiency values, customers benefit from a long lifetime of over 100,000 hours even at

high temperatures. The surface mountable component has a ceramic package that is completed by a robust silicone lens.

"The significantly improved efficiency values help our customers save energy. Thanks to the proven compact footprint of 3.0x3.0 mm, greenhouse owners can easily bring existing lighting systems up to date with the latest LED technology", said Mr. Chew.

Horticulture lighting technologies from Osram not only help produce fresh food in smaller spaces without the use of pesticides, they also make it easier for consumers in urban areas to obtain fresh and healthy food quickly. ■

## UV & IR

### Lextar Launches New UV LED Series for Sterilization and Curing

UV LED technology is regarded as a more efficient method of treating microorganisms in drinking water. This technology has been valued and included into drinking water treatment standard by NSF International last November for microbial reduction and provides a new test method to certify manufacturer claims.

There are only a few manufacturers who can provide UV chip, package and module at the same time, however, Lextar, the leading LED manufacturer with cutting-edge technology can provide one stop service to meet different demands. The latest package-PU35CM2 with special optical lens design allows narrow viewing angle for better radiation power output which can increase the efficiency of microbial reduction. In addition, small power below 15 mW is ideal for water sterilization in carry-on water bottle. PU88S31 which was launched last year is perfect to sterilize solid daily product such as tableware, toothbrush case, pacifier, contact lenses, etc. Different



Lextar's latest generation of UV LEDs are now able to fulfil critical tasks like sterilization and curing more efficient than ever before

wavelength can not only be applied to sterilize but curing. For example, PU21 and PU88 series are widely applied in manicure and

**CEZOS** Partner of the European Lighting Industry

**ROLLI Height Adjustment System**

LED LIGHT SOURCES with/without LED CONTROLLER

- ✓ Height Adjustment System for ceiling lamps
- ✓ Maximum Voltage - 60 VDC  
Maximum Current - 4 A
- ✓ Min. lamp weight = 0,4kg  
Max lamp weight = 3kg
- ✓ Dedicated **ProxiDimmer** for **ROLLI System**, compatible with frosted and opal diffuser

**CEZOS**  
81-534 Gdynia  
POLAND,  
Olgięrdza 88/b

tel. +48 58 664 88 61  
cezos@cezos.com  
www.cezos.com



printing machine. It is worth noting that Lextar can be found in US TOP 5 nail lamp brands. ■

RESEARCH

## LRC Evaluates Hybrid UV/Blue Light Lighting System to Reduce Healthcare-Associated Infections

People who visit hospitals are expecting care and treatment, not additional complications, yet approximately 1 in 25 patients contract healthcare-associated infections (HAIs) in U.S. hospitals, according to the Centers for Disease Control and Prevention (CDC). Standard cleaning procedures usually involve manual application of detergents and disinfectants. Unfortunately, the efficacy of these manual cleaning procedures can vary considerably. In fact, less than 50% of patient room surfaces are properly cleaned. Given the



The research results from LRC showed the effectiveness of the tested system but it also suggests that UV-A resistant equipment and furnishing is required

rather poor effectiveness of manual cleaning, the Lighting Research Center (LRC) at Rensselaer Polytechnic Institute is investigating alternate, so-called, no-touch methods, including short-wavelength light, ranging from ultraviolet (UV) to blue light (200 nm to 410 nm). Short wavelengths can kill pathogens through a variety of pathways, depending upon the wavelength, the duration, and the amount. The expectation is that decontamination of room surfaces will improve when the human element is removed.

LRC researchers tested a new hybrid lighting system, developed by GE Current, a Daintree company, which was designed to provide both visible white light and disinfecting UV-A. The system was retrofitted into a modern hospital newborn intensive care unit (NICU) at the Memorial Beacon Children's Hospital in South Bend, Indiana. The UV-A dosing was set to levels calculated to be safe for human occupation. Eight-hour exposures on counter surfaces were effective for suppressing pathogens identified by the CDC as highly

problematic for healthcare facilities. LRC researchers also conducted a survey aimed at assessing the opinions of professional staff working in the NICU about the hybrid lighting system. Staff members accepted the hybrid lighting system, and the comments about the system were generally positive. An analysis of photodegrading effects suggested that UV-A resistant equipment and furnishing may need to be installed with this technology. The findings were recently published in *Lighting Research & Technology*.

"This lighting technology offers great promise in hospital applications," said Jennifer Brons, Director of Design Demonstrations at the LRC. "We are currently planning future demonstrations in another hospital unit with greater bioburden."

*"Reducing healthcare-associated infections is critically important."*

DR. MARK REA, LRC PROFESSOR

"Unfortunately, the prevalence of these infections is only expected to rise. The present findings should form the foundation for the next generation of this technology", said Dr. Rea. ■

## Flickering Light Mobilizes Brain Chemistry that May Fight Alzheimer's

For over a century, Alzheimer's disease has confounded all attempts to treat it. But in recent years, perplexing experiments using flickering light have shown promise. The promise of flickering light to treat Alzheimer's takes another step forward in this new study, which reveals stark biochemical mechanisms: 40 Hertz stimulus triggers a marked release of signaling chemicals.

Researchers have tapped into how the flicker may work. They discovered in the lab that the exposure to light pulsing at 40 hertz - 40 beats per second - causes brains to release a surge of signaling chemicals that may help fight the disease.

Though conducted on healthy mice, this new study is directly connected to human trials, in which Alzheimer's patients are exposed to 40 Hz light and sound. Insights gained in mice at the Georgia Institute of Technology are informing the human trials in collaboration with Emory University.

"I'll be running samples from mice in the lab,

and around the same time, a colleague will be doing a strikingly similar analysis on patient fluid samples," said Kristie Garza, the study's first author. Garza is a graduate research assistant in the lab of Annabelle Singer at Georgia Tech and also a member of Emory's neuroscience program. One of the surging



The hope of flickering light to treat Alzheimer's takes another step forward in this new study as it indicates that 40 Hertz stimulation triggers a marked release of signaling chemicals – cytokines (Credit: Georgia Tech / Eavenson / Karcz)

signaling molecules, in particular, is associated with the activation of brain immune cells called microglia, which purge an Alzheimer's hallmark - amyloid beta plaque, junk protein that accumulates between brain cells.

### Immune signaling

In 2016, researchers discovered that light flickering at 40 Hz mobilized microglia in mice afflicted with Alzheimer's to clean up that junk. The new study looked for brain chemistry that connects the flicker with microglial and other immune activation in mice and exposed a surge of 20 cytokines - small proteins secreted externally by cells and which signal to other cells. Accompanying the cytokine release, internal cell chemistry - the activation of proteins by phosphate groups - left behind a strong calling card.

"The phosphoproteins showed up first. It looked as though they were leading, and our hypothesis is that they triggered the release of the cytokines," said Singer, who co-led the new study and is an assistant professor in the Wallace H. Coulter Department of Biomedical Engineering at Georgia Tech and Emory.

"Beyond cytokines that may be signaling to microglia, a number of factors that we identified have the potential to support neural health," said Levi Wood, who co-led the study with Singer and is an assistant professor in Georgia Tech's George W. Woodruff School of Mechanical Engineering.

The team publishes its findings in the *Journal of Neuroscience* on February 5, 2020. The research was funded by the National Institute of Neurological Disorders and Stroke at the National Institutes of Health, and by the Packard Foundation.

Singer was co-first author on the original 2016

study at the Massachusetts Institute of Technology, in which the therapeutic effects of 40 Hz were first discovered in mice.

### Sci-fi surrealness

Alzheimer's strikes, with few exceptions, late in life. It destroys up to 30% of a brain's mass, carving out ravines and depositing piles of amyloid plaque, which builds up outside of neurons. Inside neurons, phosphorylated tau protein forms similar junk known as neurofibrillary tangles suspected of destroying mental functions and neurons.

After many decades of failed Alzheimer's drug trials costing billions, flickering light as a potentially successful Alzheimer's therapy seems surreal even to the researchers.

*"Sometimes it does feel like science fiction."*

SINGER

The 40 Hz frequency stems from the observation that brains of Alzheimer's patients suffer early on from a lack of what is called gamma, moments of gentle, constant brain waves acting like a dance beat for neuron activity. Its most common frequency is right around 40 Hz, and exposing mice to light flickering at that frequency restored gamma and also appears to have prevented heavy Alzheimer's brain damage.

Adding to the surrealness, gamma has also been associated with esoteric mind expansion practices, in which practitioners perform light and sound meditation. Then, in 2016, research connected gamma to working memory, a function key to train of thought.

### Cytokine bonanza

In the current study, the surging cytokines hinted at a connection with microglial activity, and in particular, the cytokine Macrophage Colony-Stimulating Factor (M-CSF).

"M-CSF was the thing that yelled, 'Microglia activation!'" Singer said.

The researchers will look for a causal connection to microglia activation in an upcoming study, but the overall surge of cytokines was a good sign in general, they said. "The vast majority of cytokines went up, some anti-inflammatory and some inflammatory, and it was a transient response," Wood said. "Often, a transient inflammatory response can promote pathogen clearance; it can promote repair."

"Generally, you think of an inflammatory response as being bad if it's chronic, and this was rapid and then dropped off, so we think that was probably beneficial," Singer added.

### Chemical timing

The 40 Hz stimulation did not need long to trigger the cytokine surge. "We found an increase in cytokines after an hour of stimulation," Garza said. "We saw phosphoprotein signals after about 15 minutes of flickering." Perhaps about 15 minutes was enough to start processes inside of cells and about 45 more minutes were needed for the cells to secrete cytokines. It is too early to know.

### 20 Hz bombshell

As controls, the researchers applied three additional light stimuli, and to their astonishment, all three had some effect on cytokines. But stimulating with 20 Hz stole the show. "At 20 Hz, cytokine levels were way down. That could be useful, too. There may be circumstances where you want to suppress cytokines," Singer said. "We're thinking different kinds of stimulation could potentially become a platform of tools in a variety of contexts like Parkinson's or schizophrenia. Many neurological disorders are associated with immune response."

The research team warns against people improvising light therapies on their own, since more data is needed to thoroughly establish effects on humans, and getting frequencies wrong could possibly even do damage.

### Story References:

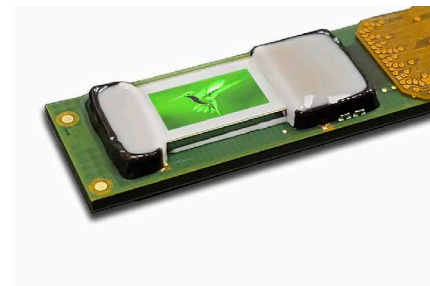
Materials provided by Georgia Institute of Technology. Original written by Ben Brumfield. Journal Reference: Kristie M. Garza, Lu Zhang, Ben Borron, Levi B. Wood, Annabelle C. Singer. Gamma Visual Stimulation Induces a Neuroimmune Signaling Profile Distinct from Acute Neuroinflammation. The Journal of Neuroscience, 2019; 1511-19 DOI: <http://dx.doi.org/10.1523/JNEUROSCI.1511-19.2019> ■

## Compound Photonics and Plessey Create microLED Display Modules from Bonded Wafers

Compound Photonics US Corporation (CP), a leading provider of compact high-resolution microdisplay solutions for Augmented Reality (AR) and Mixed Reality (MR) applications, and Plessey Semiconductors Ltd. (Plessey), an embedded technologies developer at the forefront of microLED technology for AR and MR display applications, today announced they have produced the first fully addressable microLED display modules resulting from their previously announced strategic partnership to develop and introduce GaN-on-Silicon microLED based microdisplay solutions for AR/MR applications.

CP and Plessey engineering teams have

successfully fabricated functional microLED display modules combining CP's industry-leading high speed digital low-latency display backplane with Plessey's breakthrough GaN-on-Silicon monolithic microLED array technology. Plessey's team produced the microLED array wafer bonded to CP's backplane wafer at its Plymouth, UK, facility. In turn, CP's team assembled and packaged display modules from the bonded wafer pair at its Phoenix, AZ, USA, facility. Both teams are currently performing initial characterization work at CP's Vancouver, WA, USA, facility. "Today's milestone achievement is a direct



Global Leaders in microdisplay system technology and microLED technology, Compound Photonics and Plessey, announced first functioning microLED prototypes

result of the close working relationship between Plessey and CP development teams," commented Mike Lee, President of Corporate and Business Development at Plessey. "This successful proof-of-concept demonstration validates both companies' goals to produce the industry's highest performance microLED display modules that deliver improved brightness at the smallest pixel sizes, higher frame rates, with extended bit depth at the lowest power consumption to best serve next-generation emissive display-based AR/MR smart glasses and Heads-Up/Head-mounted displays (HUD/HMDs) applications."

Yiwan Wong, Compound Photonics' CEO, added: "These prototype microLED displays provide important confirmation that Plessey's monolithic GaN-on-Silicon IP, fabrication technology and bonding processes match perfectly with CP's industry leading 3.015 micron pixel pitch 1080p (1920x1080 pixel) backplane design to deliver compact high resolution microdisplays. Combined with CP's NOVA high-performance display driver architecture, these microLED displays support an industry standard MIPI interface to take advantage of CP's unique display pipeline solution designed for the real time needs of AR/MR applications. CP's display drive technology is extensible across multiple display technologies enabled by full software configurability, allowing customers to build their systems for specific power and performance needs."

Initial samples of a 0.26 inch diagonal, Full HD 1080p resolution microLED display module

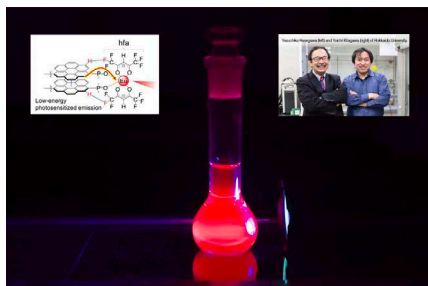
integrated with display driver IC and MIPI input are expected to be available by summer of 2020. ■

## Researchers from Hokkaido University Let Europium Shine Brighter

A stacked nanocarbon antenna makes a rare earth element shine 5 times more brightly than previous designs, with applications in molecular light-emitting devices. - The europium Eu(III) complex with nanocarbon antenna emitting fine red light.

A unique molecular design developed by Hokkaido University researchers causes a europium complex to shine more than five times brighter than the best previous design when it absorbs low energy blue light. The findings were published in the journal *Communications Chemistry*, and could lead to more efficient photosensitizers with a wide variety of applications.

Photosensitizers are molecules that become excited when they absorb light and then transfer this excited energy to another molecule. They are used in photochemical reactions, energy conversion systems, and in photodynamic therapy, which uses light to kill some kinds of early-stage cancer. The design



The europium Eu(III) complex with nanocarbon antenna emitting fine red light. – Left inset: The Eu(III) complex containing the stacked nanocarbon structure works as an antenna to harvest light and transfer the energy to europium efficiently

of currently available photosensitizers often leads to inevitable energy loss, and so they are not as efficient in light absorption and energy transfer as scientists would like. It also requires high energy light such as UV for excitation.

Yuichi Kitagawa and Yasuchika Hasegawa of Hokkaido University's Institute for Chemical Reaction Design and Discovery (WPI-ICReDD) worked with colleagues in Japan to improve the design of conventional photosensitizers.

Their concept is based on extending the lifetime of a molecular energy state called the

triplet excited state and reducing gaps between energy levels within the photosensitizer molecule. This would lead to more efficient use of photons and reduced energy loss.

The researchers designed a nanocarbon "antenna" made of coronene, a polycyclic aromatic hydrocarbon containing six benzene rings. Two nanocarbon antennas are stacked one on top of the other and then connected on either side to the rare Earth metal europium. Extra connectors are added to strengthen the bonds between the nanocarbon antennas and europium. When the nanocarbon antennas absorb light, they transfer this energy to europium, causing the complex to emit red light.

*"The new design could be applied to fabricate molecular light-emitting devices."*

YUICHI KITAGAWA, RESEARCHER

The Eu(III) complex containing the stacked nanocarbon structure. The nanocarbon structure works as an antenna to harvest light and transfer the energy to europium efficiently, which then emits red light. (Kitagawa Y., Hasegawa Y., et al., *Communications Chemistry*, January 3, 2020)

Experiments showed the complex best absorbed light with wavelengths of 450nm. When a blue LED (light-emitting diode) light was shone on the complex, it glowed more than five times brighter than the europium complex which until now had the strongest reported emission under blue light. The researchers also demonstrated that the complex can bear high temperatures above 300°C thanks to its rigid structure.

"This study provides insights into the design of photosensitizers and can lead to photofunctional materials that efficiently utilize low energy light," says Yuichi Kitagawa of the research team.

Original article:

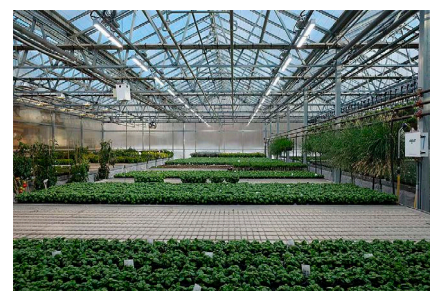
Kitagawa Y., Hasegawa Y., et al., Stacked nanocarbon photosensitizer for efficient blue light excited Eu(III) emission. *Communications Chemistry*, January 3, 2020. DOI: <https://doi.org/10.1038/s42004-019-0251-z>  
Funding:

This study was supported by Grant-in-Aid (17K14467, 19H04556, 18H04497, 18H02041) and the Institute for Chemical Reaction Design and Discovery (ICReDD), established by the World Premier International Research Initiative (WPI) of MEXT, Japan. ■

## Researchers Call for Greenhouses LED Lighting Standards

While LED lighting can enhance plant growth in greenhouses, standards are needed to determine the optimal intensity and colors of light, according to Rutgers research that could help improve the energy efficiency of horticultural lighting products.

Many lighting companies market their LED (light-emitting diode) products with claims of delivering an optimal "light recipe" that often consists of a combination of wavelengths and color ratios, such as a 4-to-1 red to blue ratio on the spectrum (colors of a rainbow). Plant scientists often use this information to evaluate the potential effects of lamps on plant growth and development. But standardized procedures on how to calculate these ratios are lacking, according to a study soon to be published in the journal *Acta Horticulturae*. "The more efficient supplemental lighting



LED lighting in greenhouses helps but Rutgers research reveals information gaps on LED lighting for indoor crops

sources are, the less electric power growers need to finish their crops," said senior author A.J. Both [1], a professor and extension specialist in controlled environment engineering in the Department of Environmental Sciences in the School of Environmental and Biological Sciences at Rutgers University–New Brunswick.

*"We hope to help make indoor crop production more sustainable and affordable."*

A.J. BOTH

Increased energy efficiency can have a big impact on the bottom line, and information about new crop lighting strategies will help the burgeoning indoor farming industry, Both said.

In greenhouses and controlled environments, electric lamps are used to supplement sunlight and extend lighting times to produce horticultural crops, such as vegetables,

flowers and herbs, according to a previous study led by Both [2]. Recent advances in energy-efficient LED technology provide the horticultural industry with multiple lighting options. But growers can't easily compare technologies and LED options because of a lack of independent data on how lamps perform. That study led to a proposed standardized product label allowing for comparisons of lamps across manufacturers.

Both and colleagues continue to focus on independently assessing performance metrics such as power consumption, efficiency, light intensity and the light distribution pattern and relaying that information to commercial growers. Recent advancements have provided opportunities to precisely control the light from LED lamps and study their impacts on plant growth and development, according to Both's research. Both and his team work closely with plant scientists who study the impact of light on plants grown for food or ornamental crops.

The new study recommends using a spectroradiometer, an instrument that measures light output across a specific range of wavelengths. Using such an instrument, various light ratios can be calculated. The researchers reported substantial differences in light ratios comparing sunlight with common lamps, including LED, high-pressure sodium, incandescent and fluorescent lamps used for plant lighting.

*The researchers hope that their work will contribute to the development of standard definitions for specific wavebands (ranges of wavelengths) that are important for plant growth and development.*

Acknowledgements:

The lead author of the new study is Timothy Shelford, a part-time research specialist at Rutgers who also works at Cornell University. Claude Wallace, a Rutgers graduate and part-time employee, also contributed to the study.

- 1 ] [https://envsci.rutgers.edu/people/faculty/profiles/both\\_aj.html](https://envsci.rutgers.edu/people/faculty/profiles/both_aj.html)
- 2 ] <https://journals.ashs.org/horttech/view/journals/horttech/27/4/article-p544.xml>

- 3 ] <https://envsci.rutgers.edu/index.php>
- 4 ] <https://sebs.rutgers.edu/>
- 5 ] <https://newbrunswick.rutgers.edu/>

The study has been carried out at the Department of Environmental Sciences [3] in the School of Environmental and Biological Sciences [4] at Rutgers University - New Brunswick [5]. ■

## SSC Develops World's First One Pixel Micro LEDs for 4K Resolution TV from 42" to 220"

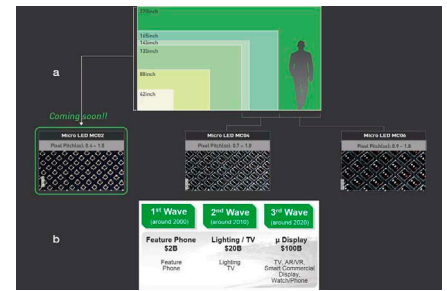
Seoul Viosys Co., Ltd. (CEO Young Joo Lee) and Seoul Semiconductor Co., Ltd. (CEO Chung Hoon Lee), leading global innovators of LED and UV LED technologies, announced the new concept display, 'Micro Clean LED' at CES 2020, the biggest global consumer electronics and technology show.

The new concept of Micro Clean LED, which Seoul Viosys developed, is the technology that realizes 4K resolution TV sizes from 42 inch to 220 inch with 1 RGB LED per pixel and is ready for mass production. The Micro Clean LED solutions for a smart watch display also will be demonstrated at CES 2020 to main strategic partners by appointment.

Seoul Viosys possesses the necessary technologies, from MOCVD for EPI growth of all 3 colors, RGB, to the transfer solution of small-sized micro( $\mu$ ) level RGB Chip. Seoul Semiconductor also possesses the tiling technology, substrate connectivity technology, for large-screen display by preparing SMT, surface mounted technology, manufacturing process at the customer's request in its own factory.

Furthermore, since it is developed as 1 pixel, it resolves 3 main challenges for micro LED, which are transfer technology, color mixing and individual color and intensity of light control. By resolving these 3 challenges, the cost can be reduced by 1/3, and the product reliability test is also completed.

In the LED market, the 1st wave was adoption of LED technology in mobile phone applications in 2000s. The 2nd wave was with LED TV and lighting applications in 2010s. As the 3rd wave grows to USD 100B market with LCD and OLED, the micro LED is expected to take a good portion of next generation display. It is also suitable for light source in VR/AR and MR market. The micro LED is the world's only light source that can deliver 1,000 times faster response time, 30 reduction of internal and external power consumption and infinite contrast range compared to existing LCD and OLED display.



Comparison of one micro pixel and existing signage micro LED (a). The next generation micro LED to lead USD 100B display market (b)

Seoul Viosys and Seoul Semiconductor already have been accumulating hundreds of patent applications and registrations for more than 10 years. Seoul Semiconductor's patent portfolio is very well-known in the world with winning all 32 lawsuits in 7 countries in the world by using 72 patents of 14,000 patent technology in past 2 years, 4 exceptional legal cases resulted in injunctions against the sales and product recalls. ■



# TECHNICAL REGULATORY COMPLIANCE UPDATE



Segment	Product	Standard (Certification)	Region	Technical Regulatory Compliance Information
Energy Efficiency	Energy efficiency labeling of LED lamps, Storage water heater, laptop computer, Motorbikes	TCVN 7898-2009	Vietnam	<p>Under the recent decision it is compulsory for the following equipment to carry an energy label: Tubular fluorescent lamps, compact fluorescent lamps, electromagnetic and electronic ballasts for fluorescent lamps, air conditioners, refrigerators, washing machines, electric cookers, electric fans, television receivers, three-phase distribution transformers, electric engines, and commercial refrigeration cabinets.</p> <p>Voluntarily LED lamps, tank water heaters and laptops may be marked till december 31, 2019. It will also be compulsory for these products from first of January 2020 onwards to be marked. Other products for which the labeling remains voluntary are: Photocopiers, computer monitors and printers.</p>
Safety	Mandatory commodity inspection	Notice No. 10230021780; Amendment Notice No. 10830007210, 2019	Taiwan	<p>The BSMI of Taiwan published on the 3rd of January 2020 a notice to change the mandatory commodity inspection of self-ballasted LED Lamps. These lamps are subject to mandatory inspection under the commodity inspection act since 2014. The BSMI changed the latest version of inspection standards CNS 14115 and CNS 15630 for these products to improve consumer protection and promote efficiency of energy use. The procedures to verify conformity for products subject to this notified measure remain the same. This change becomes effective from 3rd of January 2020.</p>
Safety	Electrical supply track systems for luminaires	IEC 60570:2003/AMD2:2019	World/Europe	<p>The IEC 60570:2003/AMD2:2019 was published with additional requirements: For auxiliary circuits for the purpose of a control or audio signal e.g. DMX, 1-10V signal,.. requirements were added. Also emergency lighting and marking requirements were added. Interchangeability requirements and the suspension test were updated. The standard was extended by accessibility test for class I tracks and also by unsafe connection test between supply and control signal. The EN version will be published without modifications.</p>
Safety	Fixed general purpose luminaires	IEC 60598-2-1:2020	World/Europe	<p>IEC 60598-2-1:2020 for 'Fixed general purpose luminaires' was published with additional requirements. Within the scope of this standard there was an update implemented to include all electrical light sources. The EN version will be published without modifications.</p>

**Disclaimer:** This information is research work of TÜV SÜD Product Service and is intended for general information purposes only. The content is publishable only after having the consent of TÜV SÜD Product Service. If it is published with any changes, the company is not liable for it. The information is subject to change and all rights for it are reserved by TÜV SÜD Product Service GmbH. A free training can be arranged for a clear understanding of the upper stated standards. For further information on the latest upgrades and testing standards and training, please contact [cps@tuv-sud.com](mailto:cps@tuv-sud.com)

# Discomfort Caused by Glare from Luminaires with a Non-Uniform Source Luminance

Glare and the resulting discomfort are a persistent issue in lighting that became even bigger with the introduction with LEDs. While the UGR method is well established, there are sometimes serious discussions about whether or not it is appropriate for SSL. The limitations of the UGR method need to be understood. Peter Thorns explains these limitations and consequently describes the research and how to apply correction measures.

## Introduction

THE Unified Glare Rating (UGR) methodology for calculating indoor discomfort glare, as given in CIE 1995 [1] and CIE 2010 [2] is well established and used internationally in many standards and codes of practice. It allows us to evalu-

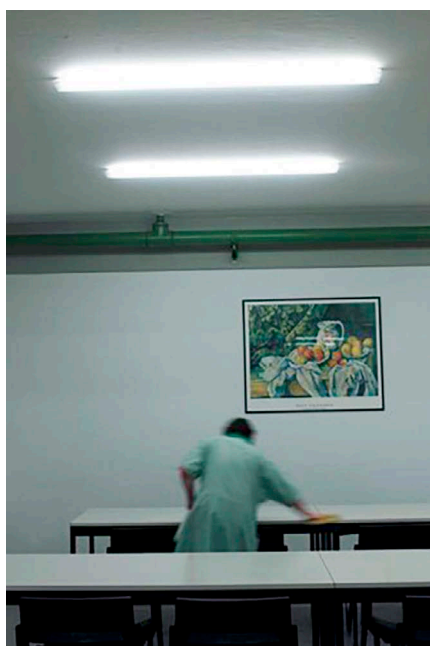


Figure 1: An example of a lighting installation with poor glare control

ate the perceived discomfort glare from lighting installations such as that shown in **Figure 1**. The standard formula is shown in **Equation (1)**.

$$R_{UG} = 8 \cdot \log \left[ \frac{0.25}{L_b} \sum \frac{L_s^2 \cdot w}{p^2} \right] \quad (1)$$

Where the summation is over all sources in the field of view and where

$R_{UG}$  is the UGR value;  
 $L_s$  is the source luminance in the direction of the observer;  
 $w$  is the solid angle subtended by the source at the observer's eye;  
 $p$  is the position index, which depends on the angular position of the source in the observer's field of view;  
 $L_b$  is the general field luminance controlling the adaptation level of the observer's eye, or background luminance.

## About the Limitations of the UGR Method

The UGR methodology has acknowledged limitations. It is limited to light sources which have a maximum subtense at the eye of between 0,0003 sr and 0,1 sr. It also uses defined limiting criteria that relate to an observer positioned against the wall of a rectangular room looking in a specific direction, as opposed to sitting at a desk in a specific location within the room. However, as a pragmatic solution that has been shown to work in the majority of situations over time the value of the methodology has been demonstrated. (For small or large light sources outside the limits of applicability for UGR, alternative methods are available in CIE 2002 [3]).

However, a further limitation of the UGR methodology is that light sources should be uniform in luminance. Research has indicated that for luminaires with a large luminance variation, the UGR formula does not correctly predict the perceived discomfort glare. Waters et al. [4] concluded that

non-uniform glare stimuli could cause more glare perception than uniform stimuli when viewed directly, but that the glare perception was nearly the same in peripheral vision. Takahashi et al. [5] reached the same conclusion and added the observation that a glare source with a matrix arrangement has a higher position index than a uniform glare source. Tashiro et al. [6] concluded that the discomfort glare from non-uniform light sources is larger than that of uniform light sources when the illuminance at the observer's eye remains the same.

The results of one research paper from Hara et al. [8] are shown graphically in **Figure 2** and clearly show the change in perceived discomfort glare between a uniform and a non-uniform stimulus.

## Research on Corrections of the UGR Formula

Many researchers have proposed corrections to the UGR formula to account for this, however with little consensus of a single unified solution. The corrections are generally based on adjustments of the position index, the average source luminance or the solid angle for the luminous area.

In response to this issue the CIE set up a joint technical committee, with experts from Division 1 (Vision and Colour) and Division 3 (Interior Environment and Lighting Design).

Tasks of the Joint Technical Committee:

- Review the literature on glare from non-uniform sources

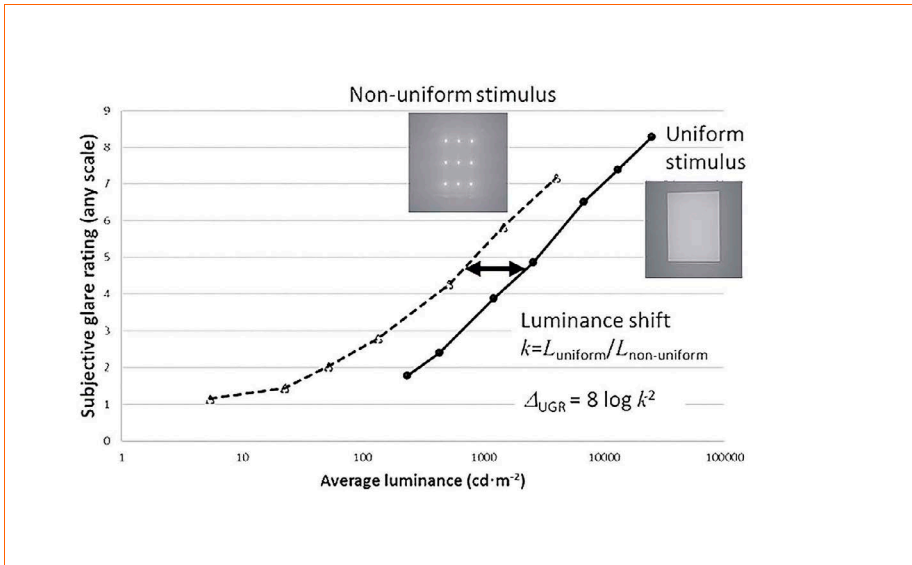


Figure 2: Difference in UGR (DUGR) between a non-uniform and a uniform glare source according to Hara et al. [8]

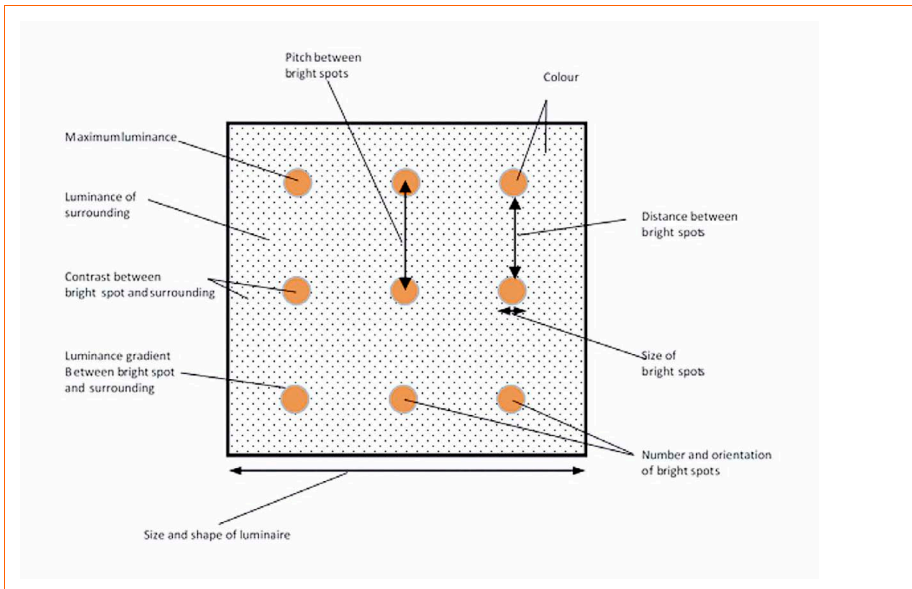


Figure 3: Luminance pattern related parameters that influence glare perception [7]

- Identify the parameters that influence the discomfort prediction
- Define limits to the applicability of the UGR formula
- Propose a correction to the UGR formula to account for non-uniform glare sources

The result is the technical report CIE 232:2019 Discomfort Caused by Glare from Luminaires with a Non-Uniform Source Luminance [7], a report that describes a method to adjust the UGR formula to account for non-uniform light sources.

Parameters were identified that influence the discomfort prediction, which can be split into either observer related parameters or luminance pattern related parameters. Observer related parameters include the

position of the source in the field of view, viewing distance, background luminance and type of task. Luminance pattern related parameters are shown in **Figure 3**.

### Research Results and Correction Methods for the UGR Formula

Research demonstrates that the lower the uniformity, the higher the perceived discomfort glare. The effects of luminance pattern related parameters on uniformity can be summarised as uniformity decreases when;

- There is a smaller area ratio between

LED and the rest of the glare source (e.g. smaller LED size, less LED per area and steeper luminance gradients)

- There is a higher luminance of LED inside the luminaire
- There is a higher luminance ratio between the LED and immediate surrounding

All of the differing approaches to modifying the existing UGR formula may be summed up by writing the formula as

$$R'_{UG} = 8 \cdot \log \left[ \frac{0.25}{L_b} \sum k^2 \frac{L_s^2 \cdot w}{p^2} \right] \quad (2)$$

where  $R'_{UG}$  is the corrected UGR value,  $R_{UG}$ , and  $k$  is a uniformity correction factor;  $k$  is based upon both the effective source area and the effective source luminance.

Alternatively, for a single glare source

**Equation (2)** may be written in terms of **Equation (1)**:

$$R'_{UG} = R_{UG} + 8 \cdot \log (k^2) \quad (3)$$

The method given to calculate a value for  $k$  is via the use of luminance images. The luminance image is used to calculate the effective solid angle of the luminous area and the effective luminance. From these values  $k$  may be calculated using **Equation (4)**.

$$k^2 = \frac{L_{eff}^2 \cdot w_{eff}}{L_s^2 \cdot w} \quad (4)$$

where

$L_{eff}$  is the effective luminance,

$w_{eff}$  is the effective solid angle of the luminous area,

$L_s$  is the average source luminance as defined in CIE 1995 [1],

$w$  is the solid angle of the source luminance as defined in CIE 1995 [1].

**Note:** By applying this new source area definition, the UGR as laid out in CIE 1995 and CIE 2010 may be applied without correction as  $k = 1$ , i.e.  $R'_{UG} = R_{UG}$ .

The luminance image may be processed in a number of ways. These are;

- EA* The effective area method, based upon a luminance threshold,
- EL - std* The effective luminance method, based upon the standard deviation of pixel values,
- EL - geom* The effective luminance method based upon the geometric mean of pixel values.

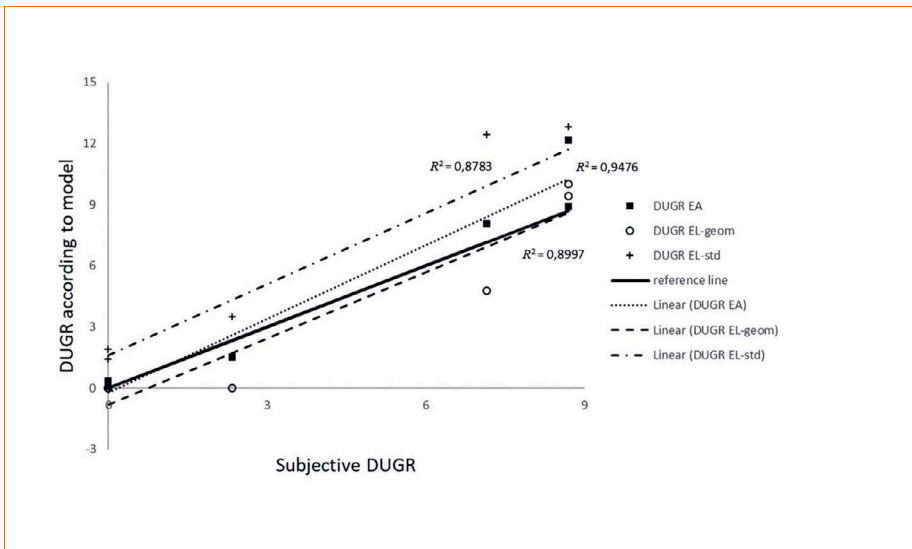


Figure 4: The difference in UGR (DUGR) between a non-uniform and a uniform glare source (experimental data of Utsunomiya University) [7]

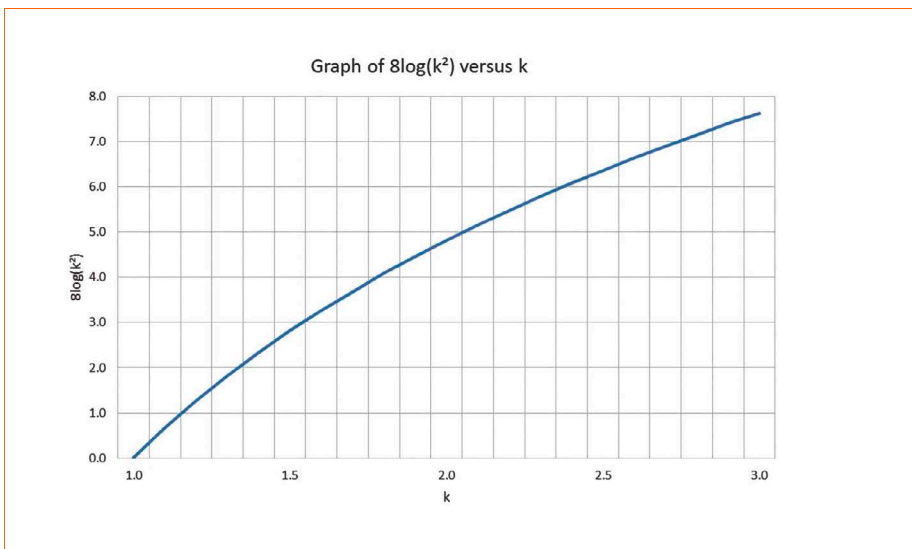


Figure 5: Values of  $8 \cdot \log k^2$  for values of  $k$

The method chosen for the correction factor shown in **Equation (4)** was *EL-geom*, based upon an analysis of how the three potential methods correctly predicted the results from a number of research studies. The results from one of these studies is shown in **Figure 4** below.

The practical implication of this is that as the non-uniformity of the glare source increases (i.e. the numerator in **Equation (4)** increases with respect to the denominator), the perceived discomfort glare will also increase because it is additive, as shown in **Equation (3)**. Representative values of  $8 \cdot \log(k^2)$ , and hence the increase in UGR value, are shown in **Figure 5** for  $k = 1$  to  $k = 3$ .

## Conclusions

In conclusion the publication CIE 232:2019 [7] provides a verified method to predict perceived discomfort glare from non-uniform light sources, overcoming the current issue of UGR values predicting lower discomfort glare than that perceived in practice from non-uniform light sources. It should therefore be used in practice to allow the design of better and more comfortable work spaces.

**Note:** This and other CIE publications are available for purchase from the CIE Webshop (<https://www.techstreet.com/cie/>). Members of CIE National Committees are eligible for a 66.7% discount on the advertised price. ■

## References

- [1] CIE 117:1995. Discomfort Glare in Interior Lighting. CIE, Vienna.
- [2] CIE 190:2010. Calculation and Presentation of Unified Glare Rating Tables for Indoor Lighting Luminaires. CIE, Vienna.
- [3] CIE 147:2002. Glare from Small, Large and Complex Sources. CIE, Vienna.
- [4] Waters CE, Mistrick RG, Bernecker CA. "Discomfort glare from sources of non-uniform illuminance". Journal of the IES 1995: 24: 73-85.
- [5] Takahashi H, Kobayashi Y, Onda S, Arikura T. "Position index for the matrix light source". Journal of Light and Visual Environment 2007: 31: 128-133.
- [6] Tashiro T, Kawanobe S, Kimura-Minoda T, Kohko S, Ishikawa T, Ayama M. "Discomfort glare for white LED light sources with different spatial arrangements". Lighting Research and Technology 2015: 47: 316-337.
- [7] CIE 232:2019. Discomfort Caused by Glare from Luminaires with a Non-Uniform Source Luminance. CIE, Vienna. <http://www.cie.co.at/publications/discomfort-caused-glare-luminaires-non-uniform-source-luminance>
- [8] Hara N, Hasegawa S. "Study on Discomfort Glare Rating on the Luminaire with LED Array". Journal of Illuminating Engineering Institute of Japan 2012: 96(2):81-88.

## ABOUT THE AUTHOR



**Peter THORNS BSc(Hons):** Peter Thorns graduated in 1985 from Sunderland Polytechnic with an honours degree in Electrical and Electronic Engineering, after which he started working for Thorn Lighting, now part of the Zumtobel Group. He is very active in ISO, CEN and BSI and in UK and European trade associations, is the Division Director for CIE Division 3, a Chartered Engineer and a fellow of both the Chartered Institution of Building Services Engineers and the Society of Light and Lighting. With a background including electronics research and development, writing technical design software, photometry and optical design, his current fields of interest include the application of light, integrative lighting, environmental concerns and energy efficiency.



Vitasolis™

Optisolis™

2-in-1 Tunable LED



# Light **so** Good

The Light **so** Good LED range delivers optimum performance in human centric lighting. **Vitasolis™** is state-of-the-art spectrum technology that stimulates human activity, while **Optisolis™** provides

a natural light source on a spectrum that's the closest match to sunlight. Plus, Nichia's **2-in-1 tunable LED** enables development of compact tunable white luminaires with superb color mixing.

**Visit us at the  
Light + Building 2020**

Hall 8 Booth G60  
27.9. – 2.10.2020  
Frankfurt am Main

# Tech-Talks BREGENZ

## Jürgen HONOLD, Program Director at Seaborough Life Sciences, The Netherlands



### **Jürgen HONOLD, Dipl.Des.(FH)**

Jürgen has worked at Technical Fellow Seaboroughs advanced lighting research and development since 2013, and founded Seaborough Life Science, a Seaborough subsidiary with the focus on light and health in 2016. With an entrepreneurial focus and interdisciplinary approach he detected several fields of interest where he started research, such as luminescent materials and advanced designs and systems. A renowned developer of lighting concepts, electronics researcher, and award winning designer, Jürgen has lived for the vision of bringing LED light to life since 1999, adding numerous inventions to his name since (Nimbus Group, LEDO, Silicon Hill & Seaborough). In his current position as Program Director of Seaborough Life Science (2019) he focuses fully on HCL, specifically on integrating photobiomodulation into General Lighting.

At LpS 2019, Jürgen Honold, Dipl.Des.(FH), and his co-presenter Dr. Martijn Dekker, held a very interesting and remarkable lecture about photobiomodulation (PBM). LED professional wanted to learn more and asked Jürgen Honold for an interview. As Technical Fellow, he is responsible for Seaboroughs' advanced lighting research and development and exactly the right person to talk with when it comes to HCL and related technologies and applications. Dr. Martijn Dekker, CEO of Seaborough accompanied him and gave an introduction with additional insights into Seaborough and the company's structure and strategy.

**LED professional: I'd like to welcome you both to the Tech-Talks Bregenz. Thank you for taking the time to give this interview. Could we start by you telling us a little about the focus and activities of Seaborough?**

**Martijn DEKKER:** First of all, we'd like to thank you for giving us the opportunity to talk about Seaborough and the exciting project that we presented here in Bregenz. Without a doubt, the LpS is the leading conference in Europe, and we were happy to be a part of it.

The company was founded in 2013. From the outset, the company focused on breakthrough inventions for LED lighting. Breakthrough – because it's private equity funded so the results must really have a significant level to justify the risk profile of a company like ours. Over the years we have worked on many different subjects. In the last two to three years we have pruned the portfolio and focused basically on three key topics that are driven by the competencies in the company. In the end, it's the people that make it happen. Those competencies are electronics, material science, and light and health in combination with system design.

In electronics we have a truly retrofit solution for tubes. A ban is to be expected there very soon and the market will have a significant pool – and we have the only product with a proven compatibility of very close to 100%. The second project is about narrow band red phosphors with close cooperation with many institutes in Europe – especially Germany and France. The third and probably most important topic that we work on today is on healthy light. – It was also the topic of our lecture in Bregenz.

The team is about 15 – 20 people who are based in a building in the science park in Amsterdam in the midst of the vibrant, vivid and entrepreneurial and science-oriented environment.

**LED professional: As far as I know, you started with technology driven topics. The first two fields you mentioned, just now. Then there was a switch from technology to life science, human centric lighting, and applications. How did this come about?**

**Jürgen HONOLD:** In my role as Technical Fellow I was responsible for filling our innovation funnel with new initiatives. After I looked for new topics and explored the field of light for health and well-being - an activity that I started in early 2016 - we first tried to develop some up-conversion phosphors for healthcare applications and phototherapies. During this first project we got in touch with the photo-bio-chemical interaction of tissue and light for the first time; a scientific field which isn't very common or well noted in the general lighting industry. And during that project we became aware of other photo-bio-chemical interactions, which is what we are focusing on now – photobiomodulation in general lighting.

**LED professional: You said that there are 15-20 people working at Seaborough – so it's quite a small company. When you do a lot of research you need a lot of capacity and I read on your home page that you work together with universities and research centers. Can you tell us a bit about your research network?**

**Martijn DEKKER:** We have a strong link to the research group of prof. Andries

Meijerink at Utrecht University, one of the best-known professors in the area on the subject of up-and down-converter materials. We also worked together with the university of Groningen on the specific up-conversion project to develop dye-antennas and then we have a Eurostars project funded by the EU that started in November, 2018. There we work together with Fraunhofer IAP, the center for applied nanotechnology, CAN, in Hamburg, FGK in Hoer-Grenzhausen close to Koblenz and a company called MJR Pharmjet near Saar Louis. When you look at the electronics, there we team up with large ODM companies in China. It's the main manufacturing base for our industry. And very specifically, we have Sengled, the number 5 ODM in China. And then there's Opplé the number one lighting brand in China and a very aggressively growing brand in Europe. These are in the public domain, as partners. Next to that, we have discussions with many other well-known companies that we sometimes can disclose and sometimes cannot disclose because of an NDA.

**LED professional: When I think about the three topics you are working on, I also think about "creating value" by using synergies: Today's LEDs aren't very efficient in the long wavelength range because phosphors aren't very effective in this range. You deal with phosphor development, as well. Wouldn't that build a bridge from one field of activities to the other?**

**Martijn DEKKER:** This actually happened during the conference! One of the LED manufacturers asked the same question. So we're thinking of doing it indirectly. The material systems for efficient narrow-band red that we work on can be applied to many wavelengths,

so a crossover is absolutely conceivable. But so far, that has only happened in my thoughts. At this stage, I don't think I could sell that to my shareholders. It could be a way for the programs to reinforce each other, but right now it's not our focus.

**LED professional:** In this case, as you presented a lecture about photobiomodulation that caught not just our attention, may I now switch directly to what you talked about yesterday? Can you explain to our readers what photobiomodulation is?

**Jürgen HONOLD:** Sometimes it is also helpful to start by understanding what it is not; so let me start by saying this: It has nothing to do with the effect of heat on the body. It is also not about the eye exclusively – because that's what the lighting industry have been focusing on, so far.

*Our understanding of light needs to be amended with the interactions of light with the whole body – with every cell in the body that can be reached by certain light intensities.*

JÜRGEN HONOLD

Photobiomodulation causes certain beneficial local effects, and subsequently systemic effects that improve health and well-being. You could say it causes a full body maintenance. It very likely causes many of the beneficial effects everyone expects and experiences when going out in the sun. Photobiomodulation is a scientific field that can explain, to a certain extent, why we feel good or why we regenerate in sunlight. This is obviously very interesting since we can aim for getting the benefits of sunlight into human centric lighting. If fully understood and transferred into general lighting we may achieve very similar effects – something that we haven't achieved, so far.

Our definition of photobiomodulation, if you look for a very short definition, is stimulation, regeneration and protection of tissue via photobiochemical interactions. It does this mainly with the red and the infrared light spectrum. And at the core of what it really does, is that it boosts the mitochondria of the cells, it improves cell metabolism. This is such a fundamental effect, which triggers a cascade of other effects, that it's very likely that photobiomodulation is beneficial for many health issues of our everyday life: For example, diseases of aging or chronic diseases. There is a lot of research about this. In the past 10 years, many activities in the medical field found support for this thesis and show a clear, positive effect of photobiomodulation on humans.

To explain this in more detail, we need to understand that this happens at a cellular

level: There are certain chromophores in the tissue, for example, the so-called cytochrome c oxidase, a terminal enzyme in the breathing chain of the mitochondria. It's assumed that this is the key chromophore that absorbs the red and NIR light. Much more is known to science already and when you talk to the active researchers in the field, they are looking to the left and right already to see what else might be happening by the complex interactions of tissue with light, for example, using other wavelengths which interact with other chromophores. To wrap this up, just imagine that life has evolved in sunlight more than a billion years, and we have just started to understand the complex interactions of living cells and light.

**LED professional:** To understand the overall picture better, let us take one step back and look at lighting, in general. Most lighting is made for humans and what is interesting to me is the fact that if we take this into account – every light should be human centric. But what do you consider to be human centric lighting – when does light become human centric?

**Jürgen HONOLD:** Exactly how the old definition defines human centric lighting. When you look it up you see that human centric light is defined as lighting that supports performance, health and well-being by means of the emotional, visual and photobiological effects of light. The common definition already encompasses the photobiological effects. But so far, we've only been looking at what is happening in the eye - also regarding the non-visible aspects of the light. So, the definition is right but the "tool-box" needs to be extended so that we're able to achieve something similar to sunlight with artificial lights. And this new tool is photobiomodulation.

**LED professional:** When talking about Human Centric Lighting in regards to health and well-being, the focus seems to be on melatonin suppression. We know that melatonin suppression is strongly related to short wavelength light. Your approach leans more towards the long wavelength light. Is this a contradiction or should light contain both?

**Jürgen HONOLD:** Certainly both. We don't say that the current scientific views

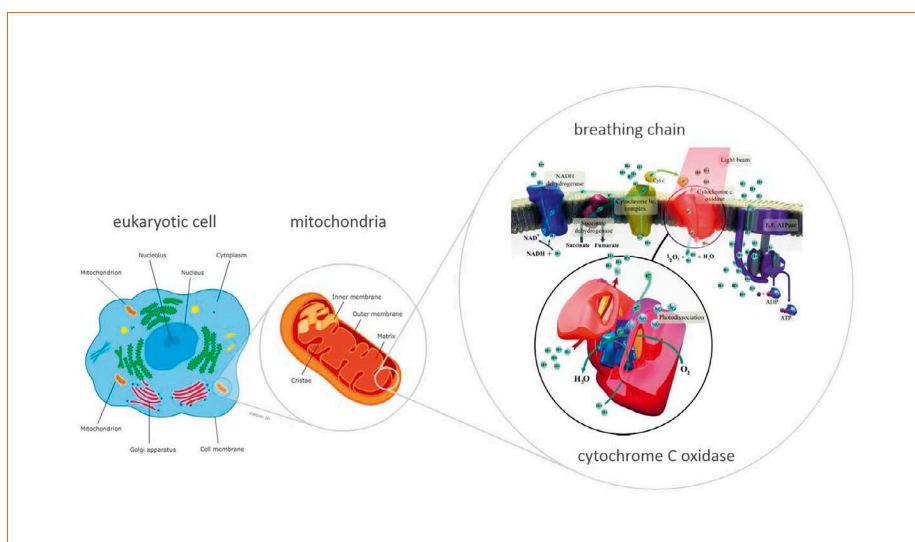


Figure 1: Cells, mitochondria & breathing chain

or assumptions are incorrect when it comes to melatonin suppression, and so on - and how it influences our health and well-being via the optical track. This is a complementary part of HCL, it has other effects. But if you observe certain effects and you only focus on the optical track, how can you be sure that the effects that you see in the research is not also partly influenced by the chromophores in the tissue? The current view is too narrow and needs to be widened. I think that in the future, we will see research factoring in all of these different pathways. Not only the eyes, but also the tissues and the related systemic effects, and there will be a holistic view on the whole topic. Only that will give you an insight into what is really going on because then you have an extended view and you can see all the causes and understand the effects that you observe.

**LED professional:** In the 66<sup>th</sup> issue of the LED professional Review we had an article that was similar to the subject of your lecture, also about introducing infrared light to a lighting system. I appreciated the fact that you didn't talk about "unhealthy" light in your lecture, but instead emphasized that the light does what it should do while it could or should be improved. Something that I miss in this discussion is the production of vitamin

**D by UV light. How far would you go? What else should be included?**

**Martijn DEKKER:** While Jürgen would have a very sound scientific answer to this, I'd like to answer it from my perspective.

We believe that there are very interesting things that we are now trying to get the full value chain to engage upon with us. This is complicated and challenging enough and you need to pretty well look at it as building blocks. We have singled out that building block and that's where we want to make an impact. Especially as a small company you need to do it this way and step by step.

**Jürgen HONOLD:** Without going into a scientific explanation – when we looked at that topic, it was clear that – of course you can add UV – but in the end, if you have a lack of vitamin D, there are many supplements on the market. The ice is very thin in this field if you want to build a business case. It's completely different if you go to PBM. It's very strong. When it comes to the science of PBM, there isn't any supplement yet that can do what PBM can do. I think adding PBM to general lighting is the only viable solution to achieve the effect that we want.

**LED professional:** You said that we have been looking at the visual segment for many years. And the opening of the pupil is only a few square millimeters in size. But if we look at photobiomodulation, the receptor is the entire area of the skin. On the other hand, about 90% of our skin is covered most of the time. So my question is: Are there areas of the skin that are more important? How big must the uncovered area be or can we reach the same effect by increasing the dose?

**Jürgen HONOLD:** If the question is if there is a relation between the radiated area and the effects that we talk about, the answer is both yes and no. So, while some effects seem to be dependent on the amount of radiated skin, like wound healing or skin rejuvenation, most of the important systemic effects, like some crucial blood modifications in the arteries and capillaries of the skin, and that's supported by scientific studies, can spread in the blood volume and therefore seem to be less dependent on the size of the radiated skin. This is what the early research of the scientific group around Samoilova et. al (1998) shows. We think, practically speaking, that ten percent of the body surface, which we have to deal with, should be enough for a decent effect. As this is supported, we think it's

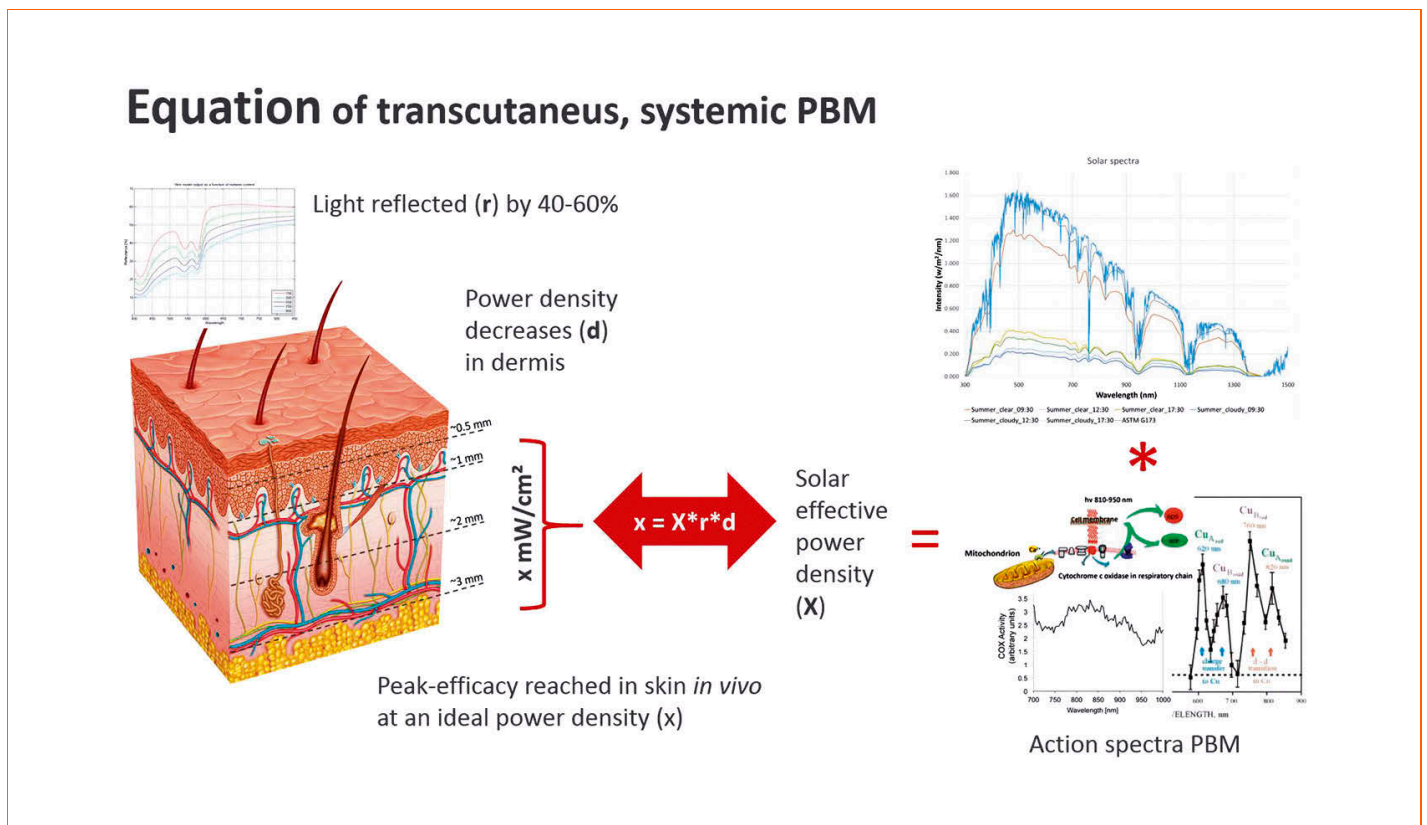


Figure 2: Equation for PBM

a viable approach and it indicates that we don't have to change the dosimetry because the systemic effects are already induced even if there is only a limited amount of exposed skin.

But to clarify: What we have is a possible hypothesis, a very likely hypothesis! We are having discussions here in Bregenz with various partners about moving into the next phase, in order to test the hypothesis in meaningful settings. The good thing is that the received feedback of leading experts in the field of PBM is unanimous that this hypothesis has a very good chance to be confirmed.

We were basically running through open doors when we started sharing this hypothesis in professional circles. The most important scientific network where these experts are connected is called WALT. It has an historic background as World Association for Laser Therapy. Fifty years ago, it all started by using red laser light, but today many of the PBM experts use LEDs, too.

When we shared our approach and thesis with the leading authorities of applied PBM and also the leading authorities in PBM research, the feedback was strong: They literally said that this is very likely the biggest application field for photobiomodulation out there in the future. At this moment we are discussing with some leading experts what we need to test and how to test it, where to test it and who will be involved. These activities are ongoing, and the first tests will be up and running very soon.

**LED professional: So that means that the effect is known, it has been proven and there is no big discussion about it. You also said that 10% of the skin should be sufficient for this effect, but for instance, how long would we need to sit here in our everyday clothes for it to have the desired effect?**

**Jürgen HONOLD:** Our calculated dosimetry can be customized for different application fields. For example, if you are in an office environment, the dosimetry needs to be adjusted to enable a sufficient PBM dose during a common working day. However, these are calculations extrapolated from scientific studies, and we have to be very careful when applying this knowledge towards new application fields! We have scientific evidence based on clinical studies where

PBM is applied as a therapy on various medical indications. Now, this is applied with a common technology that is different from ours for general lighting, and in a different context. If we extrapolate what has been published in these 10,000 papers in this field and transfer the insights into general lighting – this is, of course, fact based on current research – we still need to verify it with tests because you have a different setting. Combined with general light, you apply it in a different way. You don't apply it with therapy lamps directly on the body – you apply it from a distance, you mix it with white light, and so on. How else would you do it in general lighting? While you know that we enable the same things that have been done in medical application research and you could assume that the result is the same, the circumstances are different. You cannot be 100% sure before having the answers on some important questions: One question is, does this different setting, combined with our novel way of applying the radiation, have an influence on the biological effects? Are these effects the same that are observed in research, in a lab environment or clinical setting? We need, at first, to have solid scientific evidence about this.

Let me also link this to some other thoughts discussed here at the conference to demonstrate what other questions might be relevant. As engineers and scientists, at least as technical engineers, we often underestimate the variations between people. We've been listening to that, and I think the personal aspects of the dosimetry is one of these elements you have to consider while you're testing.

**LED professional: If you want to test the effect of PBM, what are the measurement variables? We know from melatonin suppression that we can measure it by the melatonin content in the blood or some people measure the body temperature and heart frequency rate.**

**Jürgen HONOLD:** That's a very good question. We thought about this for a very long time. We have some things in mind and we have already contacted the right scientists to discuss the next steps.

On the one hand, one option is to test if something happened with the content of the body fluids, for example by

measuring the pro- and anti-inflammatory cytokine levels. That's the content of the blood or saliva that shows the activity of the immune system. PBM induces an effect on the immune system, and the inflammatory state of the body can also be measured by the levels of cytokines.

On the other hand, you can make the so-called perception tests. You can see if a PBM application had an effect on the mood, cognitive skills, executive skills, or the awareness of the subject. - Were people, for example, sleepier? Or did the quality of their sleep improve? Did they recover faster after excessive sport?

Are they better at certain cognitive tasks? Does their productivity increase? There are also well-known tests that can be applied in combination with such perception tests to see if something is changing with regards to behavior and in the blood. This is the, so-to-speak, short-term feedback that you can measure.

We have also considered local tests, where you can basically test the state of the skin: We looked at the irradiated skin and observed something related to the first mechanism. So, if the skin is less stressed, you can irradiate it with UV or stress it in other ways – cigarette smoke, or what you have – there are several ways to introduce that. Then you apply the PBM therapy using our technology and you measure the state of the skin. In theory we should be able to find some indications that we have caused a beneficial local effect.

Altogether, the combination of these tests will give us fundamental insights about whether or not we have caused something.

However, there's still a lot we don't know in this field yet. We need to test everything, and it's a challenge. PBM is not like math: You have to collect a lot of indications and make a lot of tests to build your case. It's possible that we will discover things that we didn't expect.

**LED professional: In your lecture you mentioned that there was about 5% added energy needed to provide an effect. Is it a narrow band or a broad band that can induce these effects in humans?**

**Jürgen HONOLD:** It's quite broad, actually. It's not like you can use the whole spectrum – you need to cover certain bands between 600–950 nm. For example, we know that at around 720–750 nm practically nothing happens, so there is a gap. However, these chromophores absorb quite broadly and there's also some overlap. Anything above 950 nm, and especially above 1100 nm, is already a bit speculative. But this is just a limited view of what we know now. But that's what the designs are focused on so far, and where we have the most evidence and empiric research.

**LED professional:** So what you're saying at the current status is that 600–900 nm is the range with some smaller or broader gaps in-between.

**Jürgen HONOLD:** Yes, and primarily cytochrome c oxidase in the breathing chain of the mitochondria is responsible for this absorption range. However, often are just two distinct peaks considered but we use a more generalized approach. We factor in different published action spectra from empiric research and also clinical studies with slightly different wavelengths. So, you will find small differences in the published action spectra, but they are mostly in harmony. I think it has to do with the different cells which are used in these very specific scientific studies, and the single effects which are observed. When targeting the whole body, a less specific action spectrum is most likely the best way to go.

**LED professional:** The reason I asked was to understand which LEDs could be used as with a phosphor you usually have a broader spectrum and for an LED that is designed for infrared you often have a smaller spectrum.

**Jürgen HONOLD:** At this stage there is no reason to say that either one of the two is excluded. For example, when you look at the IREDs, that's the abbreviation for infrared emitting diodes, they are designed to have a quite broad emission – around 100 nm. As there is no need to have a very narrow band, there's also no limitation in using these sources. However, it's not that straight forward how to drive the various sources available – that's our secret sauce.

**LED professional:** Another point that I would like to address before coming

to the final round is the very interesting point that you explained that the dose of a 100W incandescent lamp was too low for an effect and now we have LED technology that will take us one step closer to better health and HCL.

**Jürgen HONOLD:** LEDs offer the versatility which is necessary to do this. Outside the regime of energy savings, there are very few examples that have been recognized by the general public where we have utilized the versatility of LED technology. This is now one of the future examples where we may bring real value to the end user and businesses, that could not have been done before the LED was there.

To come back to the incandescent Lamp, it's an integral system architecture that can only be driven in one simple modus, and of course it can be dimmed. 95% of the energy is converted into heat and simple infrared radiation, which means that the required energy would be available to enable a PBM effect, but the dose, as supplied by the lamp, has no effect. It also can't be driven in a smart way to have such an effect.

With LEDs, we just need to add less than 5% of infrared to the visible light, but this tiny amount of energy is enough to enable PBM since we can customize and drive LEDs in a smart way.

**LED professional:** I think we've broadly covered the topic of the PBM. Are there any other topics that could pop up in SSL in the future that would be interesting to you? Or, since you're a small company and you're already working in these three fields, will you just stay focused on those topics?

**Jürgen HONOLD:** Within light and health, we will definitely stay with PBM because this is a new topic with so many possible applications. It will keep us busy for the next ten years, at least. There are so many enabling technologies we need to develop on all system levels, and we are also looking for partners to help make it happen. There is still a lot to do in order to introduce PBM to the market.

**LED professional:** So it's really a mid to long-term project.

**Jürgen HONOLD:** Yes, for sure.

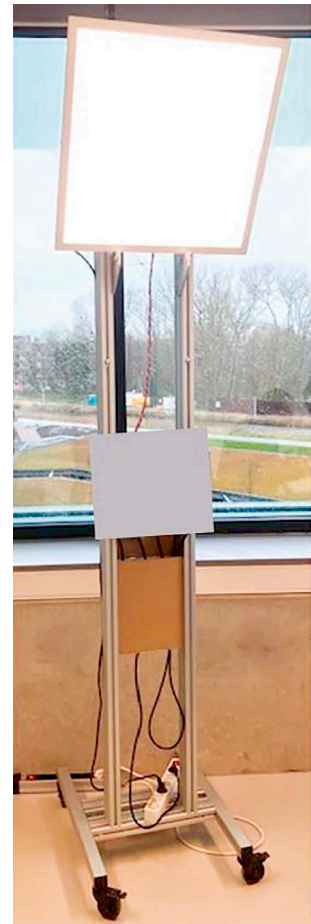


Figure 1: Office test lamp with PBM

**Martijn DEKKER:** Yes, it is and this week has been very important and instrumental in conveying the message to our shareholders that we are indeed onto something exciting. And it's important that all the parties recognize the potential. And with that done, I'm positive that we will be put in the position to make it happen. When it comes to the other programs, the situation might be different. If there had been something of the same caliber, cooking, we probably wouldn't have mentioned it here, but on the other hand, it doesn't happen often that you come across a topic so interesting, with so much potential, as the one we came across during the last one and half years.

**LED professional:** In closing I'd like to say that it seems like you have opened up a new topic for general lighting and we are curious to see what you develop over the course of the next year. Thank you very much.

**Jürgen HONOLD:** Thank you.

**Martijn DEKKER:** Thank you. ■



# TAIWAN INT'L LIGHTING SHOW

**Taipei Nangang  
Exhibition Center, Hall 1 (TaiNEX 1)**

**2020  
Oct 14-16**

## Exhibit Category:

- Lighting Integration
- Lighting Design
- Home/Residential Lighting
- Commercial Lighting
- Intelligent Lighting
- Outdoor Lighting
- Lighting for Kitchen & Furniture
- Plant Factory & Lighting
- Automotive Lighting
- Special Lighting
- Health Care and Institutional Lighting
- Medical, Cosmetic and Beauty Lighting
- Building Material & Lighting Applications
- Neon/Light Boxes
- Lighting Accessory
- Lighting Production Equipment
- Test & Inspection Equipment
- LED Process Equipment, Materials and Components

[www.TILS.com.tw](http://www.TILS.com.tw)



smart DESIGN  
radiant LIFE

Sponsored by :



Bureau of Foreign Trade, MOEA  
[www.trade.gov.tw](http://www.trade.gov.tw)

Organized by :



Taiwan External Trade  
Development Council (TAITRA)  
[www.taipeitradeshows.com.tw](http://www.taipeitradeshows.com.tw)



Taiwan Lighting Fixture  
Export Association (TLFEA)  
[www.lighting.org.tw](http://www.lighting.org.tw)

AD BY BOFT



Discover cutting-edge products.  
Take away actionable insights.

The LightFair Conference includes courses on the principles of good roadway lighting, specifying the right LEDs, best practices for LED landscape lighting and more from award-winning speakers Rick Kauffman, Steven Klein, Janet Lennox Moyer and others. Four pavilions feature the latest products from top exhibitors in every category.

500+ exhibitors  
Six conference tracks  
200+ hours of accredited courses

LightFair 2020.  
Early-bird pricing ends March 2.

**Register today at [lightfair.com](http://lightfair.com).**

**lightfair®**

**"Lightfair 2020 is postponed –  
see website for new dates"**

Trade Show and Conference  
May 3–7, 2020

Las Vegas Convention Center  
Las Vegas, NV



IALD

Let's connect on social



The future. Illuminated.

# New Directive in Europe: Flicker of LED Lighting

Over the past 10 years LED lighting has gained in importance. It has also been noticed that the alternating proportion of LED light can be very high compared to incandescent lamps. Many institutions from all over the world have thought about algorithms to measure and evaluate light modulation, considering the effect it has on humans. In the meantime, directives have been established in the USA and Europe. But do the directives really have a positive effect on the health of humans and other beings? Peter Erwin, CEO and Design Engineer at Der Lichtpeter provides insight into this question.

**F**LICKER is still a persistent issue in many LED lights. On 1 October 2019 the European Commission adopted 10 Ecodesign implementing regulations, setting out energy efficiency and other requirements for product groups including LEDs. Evaluation and measurements of optical flicker is now an important new task for electronic developers who provide solutions for LED lighting applications. However, if these regulations really can guarantee a healthier light for humans, how the measurement has to be performed and how the results have to be interpreted are crucial questions. A sound understanding of the topic is required. These points and many more shall be discussed here.

## Light Modulation and Its Health Effects

### Light modulation

Optical light modulation is defined as fluctuations in the luminance (modulation) of an electrically operated lamp, which is due to the structure and construction of the lamp. The emitted light consists of a desired equable component and an undesirable alternating component [1].

The light of the sun is the ideal model in terms of the color spectrum and the absent modulation. Since time immemorial, people have tried to extend the day with artificial light.

Electric light sources such as incandescent lamps or fluorescent tubes, which are operated directly with the mains AC voltage, generally contain an alternating component at twice the mains frequency. Due to the thermal inertia, the alternating component is less with incandescent lamps than with so-called cold lamps such as fluorescent lamps, compact fluorescent lamps or SSL such as LED lamps. It is not the light-emitting element (filament, fluorescent material, semiconductor, plasma) that is responsible for the degree of the alternating component, but only the power supply that is usually integrated in the lamp base for operating the light-emitting element. It is therefore the task of the control gear to generate a direct current from the AC

mains voltage, which is associated with costs and space requirements.

### Effect on the organism

It is certain that the alternating component (modulation) has a negative effect on the nervous system of humans and other beings [1] [2]. The alternating component is a stress load for the nervous system; rapid changes in light activate the alarm system subconsciously and can have different effects depending on the frequency.

#### Main issues of light flicker and stroboscopic effects:

- Photoepilepsy or flashing-light induced seizure at frequencies below  $\approx 70$  Hz
- Possible human biological effects due to invisible flicker at frequencies above  $\approx 70$  Hz
- Stroboscopic effect and associated apparent slowing or stoppage of rotating machinery
- Migraine or severe paroxysmal headache often associated with nausea and visual disturbances
- Asthenopia, including eyestrain, fatigue, blurred vision, conventional headache, and decreased performance on sight-related tasks
- Stress on the brain with stroboscopic light because it compensates for the beta-motion of the individual images through higher cognitive processes to a nature-related flowing film

## Light Flicker Measuring Methods [3]

The impact on the organism or nervous system was recognized long ago, but since the widespread use of solid-state lighting (SSL) in this century, there have been many complaints from end users. For this reason, various institutions worldwide have made efforts to measure and evaluate the light modulation, preferably according to the sensitivity of humans.

Light modulation varies arbitrarily in its amplitude, fundamental frequency and waveform. Every single criterion affects perceptibility. As a result, inappropriate methods are either those operating in the time domain where no frequencies are taken into account at all, or those operating in the frequency domain, but where the frequency range is insufficient, or those that have non-physiological definition gaps or discontinuities.

### Rather unsuitable methods

The methods mentioned below have been analyzed within the process for the new European Eco-Design Directive and for the depicted reasons considered not suitable.

#### Method according to IES: RP-16-10

The simplest and thus most widespread method according to IES: RP-16-10 with %flicker (pure AC/DC amplitude ratios, also known as Modulation (%), modulation depth, or Michelson contrast) and flicker index (pure area ratios as shown in **Figure 1**) is the least suitable method because two values whose combination is not defined are not communicable and frequencies are not considered at all.

#### Method according to IEEE 1789 RP1

The recommendation IEEE 1789 Recommended Practice 1 from the USA is often used because frequencies are taken into account depending on the gross dependence of human sensitivity and because there is a classification ('seizure risk', 'low risk', 'no effect'). Nevertheless, the harmonic spectrum and thus the curve shape are not taken into account, because only the fundamental frequency is decisive. In the case of a modulation frequency mix, however, this may not be determinable.

Additionally, the transition from the sensitivity function for frequencies below 90 Hz to the sensitivity function for frequencies above 90 Hz contains physiologically unexplained discontinuities. Thus products with

light modulations around 90 Hz due to their design cannot be rated.

The method itself already includes the classification, from which it follows that the light of the European incandescent lamp falls into the 'risky' area, although realistically, people have not at any time complained about TLA from incandescent lamps for over 100 years.

#### Method according to CEC T24 JA10

The method according to California Energy Commission Title 24, which came into force in January 2017, including the test method "Joint Appendix 10", requires that LED products must have less than 30% modulation at frequencies below 200 Hz (**Figure 2**). This applies to full load as well as in dimmed to 20% state. The disadvantageous fact is the lack of weighting the contained frequencies according to human sensitivity, which is why a highly noticeable

flicker at low frequencies is considered "low flicker". This may easily occur with unbalanced rectification of the mains power supply.

#### Method according to ASSIST

The procedure according to ASSIST performs a frequency analysis, weights the individual frequencies according to a sensitivity curve similar to the  $P_{st}^{LM}$  sensitivity curve shown in IEC / TR 61547-1 and sums up the components again.

With its sensitivity curve this method includes only frequencies up to 70 Hz (**Figure 2**), consequently stroboscopic effects and phantom array effects based on double mains frequency are not considered.

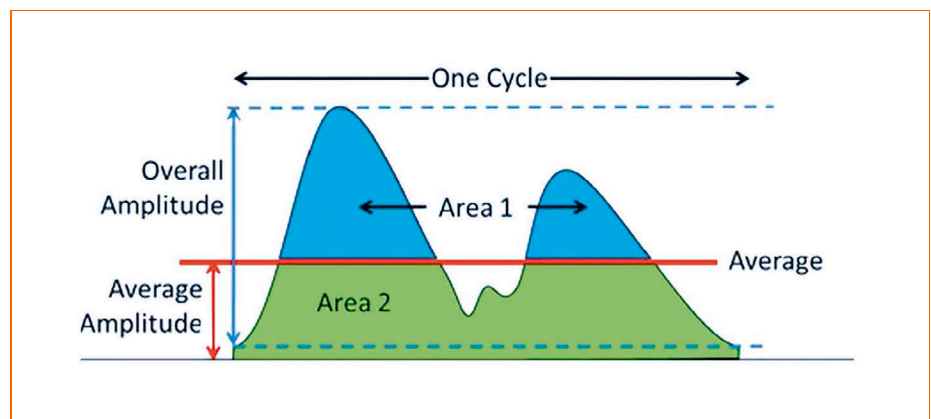


Figure 1: IES-RP-16-10 - Flicker index calculation

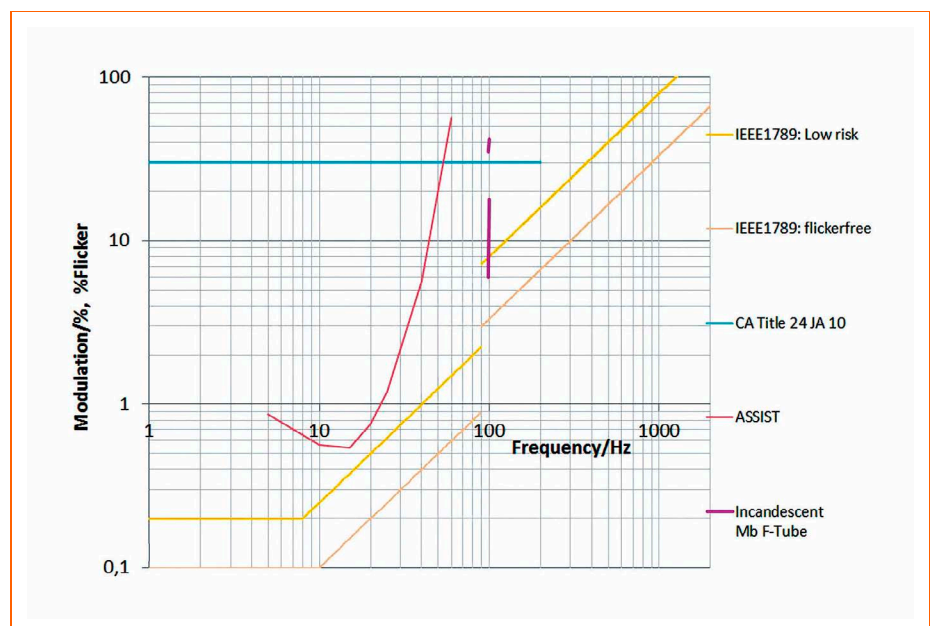


Figure 2: Sensitivity curves according to IEEE 1789 RP1, CEC T24 JA10, ASSIST

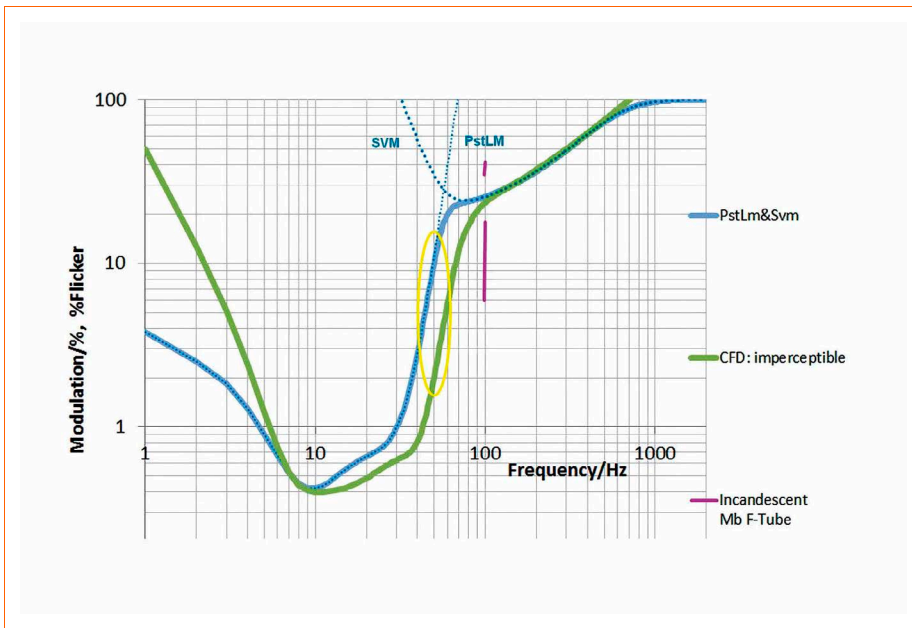


Figure 3: TLA sensitivity curves CIE (PstLM + SVM) and CFD compared

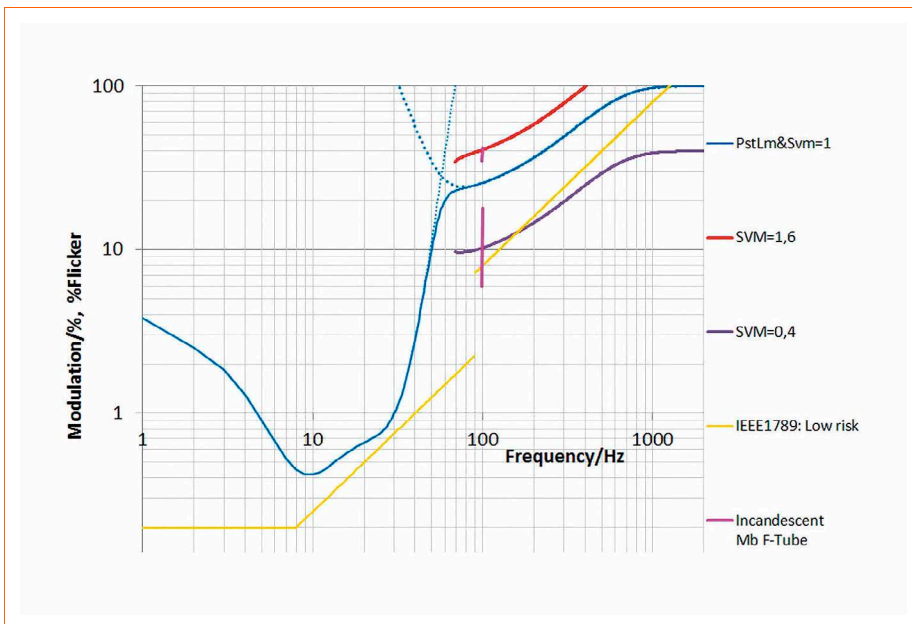


Figure 4: Sensitivity curves with SVM=1.0; 1.6; 0.4

## Appropriate methods

Useful measuring methods consider each frequency component up to at least 2 kHz, weighted according to human sensitivity, because humans (and other seeing beings) perceive light modulation depending on the containing frequencies.

To compute this properly, a frequency analysis and thus a powerful CPU is required.

### Method according to CIE: TLA (Pst<sup>LM</sup> + SVM), NEMA 77

The Technical Committee TC 1-83 of the International Commission on Illumination CIE ("Commission Internationale de

l'Éclairage") describes light flicker with the term "Temporal Light Artefact" (TLA).

Accordingly Pst<sup>LM</sup> (Short Term Flicker Indicator based on IEC/TR 61547-1) method is used, where a value of Pst<sup>LM</sup> = 1 means that the average observer has a 50% probability of detecting flicker. This part, though, is not sufficient due to its low cut off frequency at about 70 Hz. The lack is supplemented by the SVM method (stroboscopic visibility measure according to CIE TN 006:2016), where SVM = 1 represents the visibility threshold for an average observer (Figure 3).

The resulting two values for the measurement of temporal light artifacts are some-

what complicated with regard to communication and a normative regulation of application-specific limit values. Additionally it might happen that in the transition area a theoretical total actually intended value can be above the limit, even if the individually considered values are considered good.

The NEMA 77 standard has adopted this determination method.

### Method according to Der Lichtpeter: CFD

The Compact Flicker Degree (CFD) developed by Der Lichtpeter has been a template for a way to measure, declare and assess temporal light artifacts, because this method provides a single percentage value for the entire frequency range effecting on humans with frequency-dependent weighting and without definition gaps or discontinuities (Figure 3).

### Comparison:

Both methods, CIE-TLA and CFD, are quite similar in their way of calculation and sensitivity curves (Figure 3). Apart from the fact, that the CFD only needs one value to cover the whole range of human perception, CIE-TLA and CFD differ in several points.

### Differences between CIE-TLA and CFD:

- The CIE-TLA calculation is more tolerant towards measure- and calculation uncertainty
- It tends to rate mainly the fundamental frequency and thus neglects the waveform more than the CFD calculation
- At around 50 Hz the CFD curve shows a sensitivity that is 5 times higher

## Decision of the EU Commission

Due to the long-term establishment and experience of Pst for light flicker (IEC/TR 61547-1) and the sufficiently wide frequency range for stroboscopic effects, the EU Commission decided for the combination of Pst<sup>LM</sup> and SVM.

### Limit values

On December 5, 2019, the EU Commission published requirements for the design of light sources in the new directive 2019/2020 [4]. It will come into force on September 1st, 2021 and is directly applicable in every member state. Among other things, this regulation also provides measures against temporal light artifacts.

After several public submissions, the EU commissioners voted as limit values  $Pst^{LM} \leq 1.0$  and  $SVM \leq 0.4$  at full-load for LED and OLED MLS light sources intended for use in indoor applications, where lighting standards require a  $CRI \geq 80$ .

Instead of the original value of  $SVM = 1.0$ , envisaged by the CIE, which represents the visibility threshold for an average observer, for LED light sources the value of  $SVM \leq 0.4$  at full-load is required (Figure 4).

This excludes the possibility of stroboscopic effects even with short blanking at double mains frequency.

But on the other hand this leads to the fact, that, similar to IEC60883, many of the European incandescent lamps are out of the admissible range, which does not

matter by considering that this directive only applies to LED light sources.

### Oppositions

Based on the NEMA 77 standard, industry associations such as LightingEurope or NEMA are trying to relax the SVM limit to  $\leq 1.6$  (Figure 4) [5]. They assert that customers would be left in the dark because it was not feasible to supply the relevant products before the entry into force. In particular, the smaller designs with bases such as E14 or G9 would be affected.

In fact, the SVM value of 1.6 is worse than 1.3 with fluorescent tubes under magnetic ballast and enables strobe light as a market example shows (Figure 5) [6].

Both in a counter notification and in a market overview of over 1200 products, Der Lichtpeter showed in July 2019, that the market was already able to deliver [5].

For example, 30% of the E14 and 15% of the G9 comply with the new limit values (Figure 6). Even dimmable versions are available with low flicker values.

Consequently, it is technically feasible at a market price that practically doesn't differ from the low-quality lamps offered.

### Does the regulation serve the health of humans and other living creatures?

By looking at the limit values and the associated exceptions, one can see that the regulation in Europe through the directive 2019/2020 applies to LED light sources in indoor living and workplaces. These are certainly the most important and, in terms of diversity, most of the areas. As a result, the applications with which the end user or the average punter is concerned will be covered extensively, and complaints about bad LED light will be massively reduced.

#### A closer look reveals that this directive does not include the following applications:

- Light sources in dimmed state. The dimmed living room light may flicker
- No limit values are set for outdoor lighting (e.g. street lamps): Therefore, stroboscopic light will result in causing suffering to nocturnal beings, or impairment to participants in night traffic
- Illuminations for which a  $CRI < 80$  is sufficient. This means that if the color rendering is poor, strobe light is permitted
- Lighting of outdoor sports facilities

It has long been known that different animals react differently to flickering light than humans. For example, chickens are so stressed in flickering light that they stop laying eggs. This was striking when trying to illuminate chicken coops with fluorescent tubes under magnetic ballast. Attention is also paid to low-flickering light for terrariums. Even if this area has not yet been explored, this leads to the conclusion that there are other living things that suffer under flickering light [5].

The lighting industry will try to use cheap control gears such as "driverless AC direct technology" for all applications that are not regulated. In addition to the low price, this technology has the advantage that

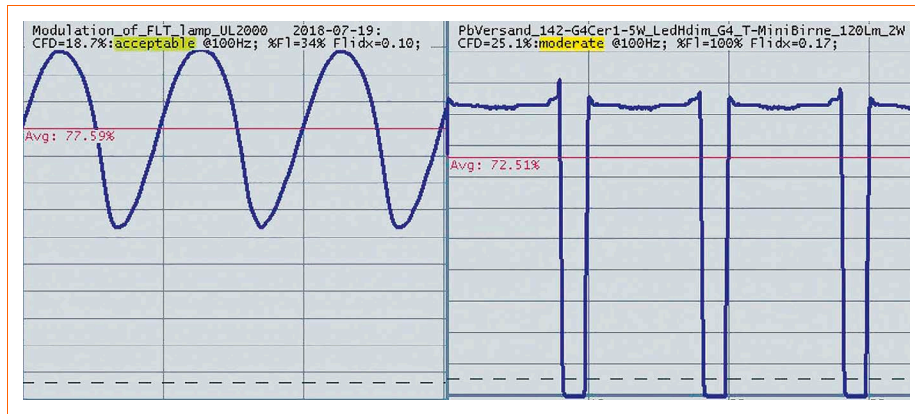


Figure 5: Light emission of a MB-Flt with SVM=1.3 and a strobe light product with SVM=1.6

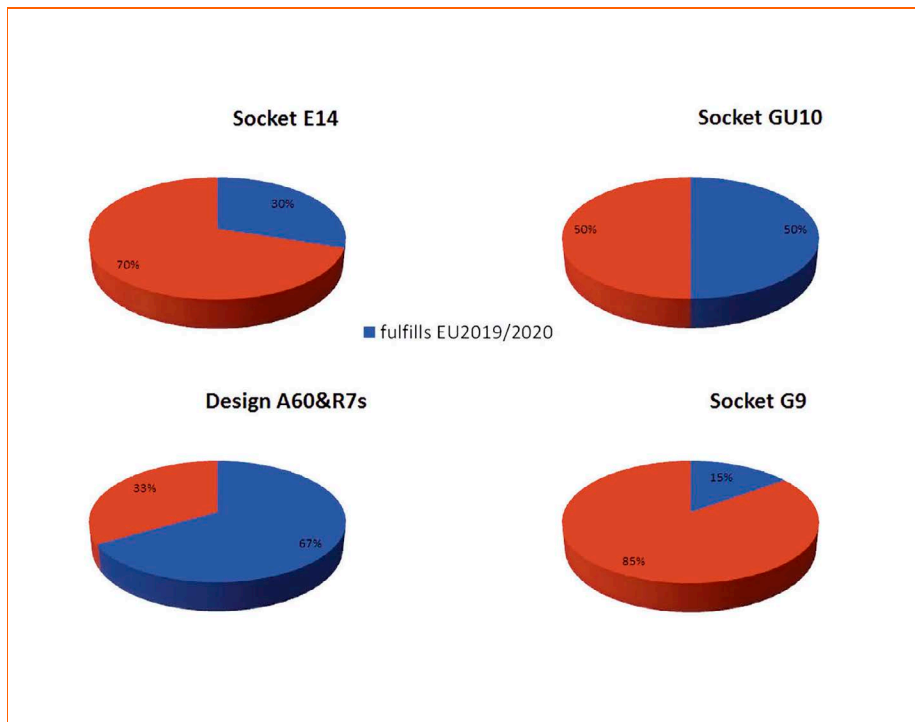


Figure 6: Market availability of LED lamps meeting the EU 2019/2020 requirements in July 2019

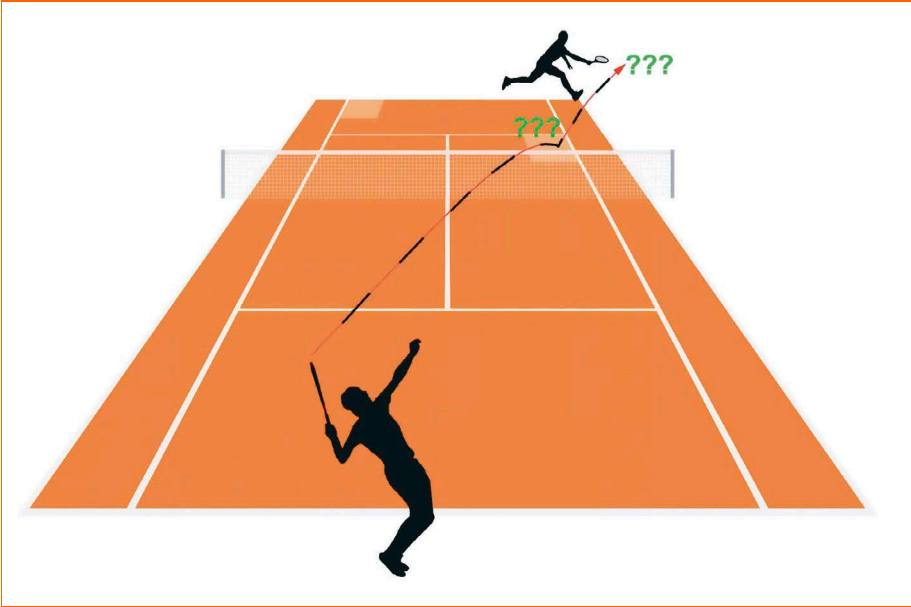


Figure 7: Visibility of a tennis ball when served with stroboscopic light



Figure 8: Self-help via smartphone to make network-dependent flicker visible

it takes up less space due to the lack of electrolytic capacitors and also prospects a longer lifetime. But this comes at the

expense of the quality of light, as far as light modulation is concerned. - Accordingly,

outdoor floodlights are currently spreading on the market.

Referring to the latest directive EN 12193:2018, temporal irregularity of electrical light sources is not regulated in any sports facility directive. This could have fatal consequences, for example, in tennis courts (**Figure 7**): At a ball speed of 50 m/s, the ball covers 20 inches each alternating between total darkness and visibility. The predictability of the flight direction after hitting the ground or the racket is possibly late, potentially too late and may lead to injuries due to the lack of ability to always determine the position of the ball.

## Conclusion

In summary, the question of serving the health of humans can be answered with 'YES', but there is still a lot of potential for further development to offer all-round help. This is also regarding other beings or outdoor applications.

## Helpful measures

IEEE 1789 in the USA and the new directive 2019/2020 in Europe work against the most common mains frequency-dependent light flicker, which is definitely a great help.

The measuring method according to California Energy Commission Title 24 JA10 is only useful to rule out strong stroboscopic light at twice the mains frequency. This is because the limit is about 3 times higher than according to IEEE 1789 or EU 2019/2020.

In contrast, the method by IES: RP-16-10: %flicker and flicker index should be prohibited for professional assessment of temporal light artifacts because they believe a judgment that is not present at all.

Until all directives come into force, however, the user can only help themselves with simple methods to detect the majority of the lamps flickering at twice the mains frequency (**Figure 8**).

## There is still a lot of potential

In general, it makes no sense to differentiate between limit values for light modulation according to the light source. In principle, the organism (that of humans or other light-sensitive beings) cannot distinguish whether the light modulation of the perceived light comes from an incandescent lamp, an LED or another electrical light

source. The decisive factor is the consistency of light with regard to the color spectrum, color temperature and frequency spectrum of the modulated alternating component.

Consequently, the measurement and assessment methods should be designed independently of the light-emitting element, the operating mode (full load, dimmed, also PWM) or the energy source (mains or battery).

In addition, limit values for light modulation should be set in application-specific categories, similar to other parameters such as color rendering [3][6]. Different distinctions should be made.

**For example, distinctions should be made between:**

- Outdoor applications, such as street lighting or parking lots
- Indoors with less demanding requirements such as consumer home lighting
- Indoor and outdoor facilities with high demands such as offices, educational institutions, machine workplaces and sports facilities, where people work concentrated over long periods of time

Furthermore, mobile lighting would have to be included because it is not evident to what extent such light should act differently than stationary lighting [5].

Stroboscopic LED daytime running lights and rear lights of motor vehicles are particularly irritating. Lighting on bicycles with dynamo driven LED headlights is problematic, because when driving slowly or with the bike pushed, massive stroboscopic flickering is generated in the very photosensitive frequency range.

In this respect, there is a need to further develop the methods and the resulting directives. Various committees are working on this, for example, within the International Commission on Illumination CIE.

**One further aspect for healthy light**

The ideal light source replaces daytime sunlight in places where people work but who are not getting sunlight. One example is a shopping mall in which there is no daylight underground or in the small shops. There, the light should come close to sunlight, which also contains an infrared and a UV component. For such locations, no LED light should be used,

but rather a heat-generated light with a high color temperature (around 5000 K). Of course, this will consume more energy, but it helps people to stay healthy. There, in the evening and in the dark, for the unnatural extension of the day, the infrared and UV components can be omitted and the color temperature can drop to below 3000 K. With regard to energy saving, LED lamps with 2700 K can be used for this purpose. ■

**References**

- [1] IEEE Standard Association; IEEE Recommended Practices for Modulating Current in High-Brightness LEDs for Mitigating Health Risks to Viewers; Mar 2015; [http://www.bio-licht.org/02\\_resources/info\\_ieee\\_2015\\_standards-1789.pdf](http://www.bio-licht.org/02_resources/info_ieee_2015_standards-1789.pdf)
- [2] European Commission, DG Health & Consumers; Emerging and Newly Identified Health Risks, Health Effects of Artificial Light; Mar 2012; [https://ec.europa.eu/health/scientific\\_committees/emerging/docs/scenih\\_r\\_o\\_035.pdf](https://ec.europa.eu/health/scientific_committees/emerging/docs/scenih_r_o_035.pdf)
- [3] Der Lichtpeter, Peter Erwin; Discussion Paper: Light flicker: Determination and Assessment; Oct 2017; [www.eup-network.de/fileadmin/user\\_upload/Lichtquellen\\_Flimmern\\_Erwin\\_2017\\_10\\_EN.pdf](http://www.eup-network.de/fileadmin/user_upload/Lichtquellen_Flimmern_Erwin_2017_10_EN.pdf)
- [4] European Commission; EC and EU Regulations Directive No 2019/2020/EU (Product Design); Dec 2019 [https://www.eup-network.de/fileadmin/user\\_upload/Lichtquellen\\_VO\\_2019\\_2020\\_EU\\_EN.pdf](https://www.eup-network.de/fileadmin/user_upload/Lichtquellen_VO_2019_2020_EU_EN.pdf)
- [5] Der Lichtpeter, Peter Erwin; Counterstatement to the comments of LightingEurope; Affirmation of the SVM limitation of  $\leq 0.4$ ; Jul 2019; [https://www.eup-network.de/fileadmin/user\\_upload/Lichtquellen\\_Stellungnahme\\_Erwin\\_2019\\_07\\_EN.pdf](https://www.eup-network.de/fileadmin/user_upload/Lichtquellen_Stellungnahme_Erwin_2019_07_EN.pdf)
- [6] Der Lichtpeter, Peter Erwin; Light Modulation: SVM Limitation; Jul 2018; [https://www.eup-network.de/fileadmin/user\\_upload/Lichtquellen\\_Diskussion\\_SVM\\_Erwin\\_2018\\_07\\_EN.pdf](https://www.eup-network.de/fileadmin/user_upload/Lichtquellen_Diskussion_SVM_Erwin_2018_07_EN.pdf)

**ABOUT THE AUTHOR**



**Peter Erwin:** Inventively minded design engineer with 25 years of experience in innovative design and development of MCU controlled hardware and software for customer-friendly, intuitive and easy to use devices and applications.

Since 2010, the topic of lighting with artificial light has been important in Peter Erwin's own interest. The focus of his work lies in the determination of optical light flicker. This unpopular but nevertheless very important technical property of a luminous means needs paying more attention in view of the growth rates of flickering illuminants in the market. For this reason, Der Lichtpeter was founded. Der Lichtpeter works for the benefit of humans and invests some money and about 1000 working hours per year.

In 2018, Peter Erwin has been working together with IEC TC 34 / WG 5 and is a member of the International Commission on Illumination research forum RF-02 to support standards against light flicker.

# In Search of the Perfect Light

The question of the perfect light has interested people for generations. Dr. Stephen Mason, Managing Director at Sustainable Eye Health in Australia, has drawn interesting conclusions by combining the results of studies and research with new technological developments.

**T**he discovery of passing an electric current through a semi-conductor and observing it to emit light in the early 20th Century began a journey of discovery in physics and engineering to the present day where highly efficient light-emitting-diodes can be processor-controlled and programmed to vary radiance and wavelengths as a function of time. This paper explores the parameters of indoor lighting fixtures when considering the optimal solutions to support vision and systemic health, our comfort and human performance in the context of global societies becoming progressively more urbanised. The human visuo-sensory system is highly dependent on exposure to appropriate levels of sunlight for both health of the very organs that sense light, our eyes, as well as the healthy support of our systemic circadian clocks.

## LED Lighting – A Remarkable Discovery and a Work in Progress

Capt. H.J. Round, working in Marconi Laboratories in 1907 reported to the editors of *Electric World* on the effects of passing a current through “a junction of carborundum and another conductor” and was surprised to see it emit various colours (predominantly green/ yellow, orange and blue). This phenomenon of ‘electro-luminescence’ was the first recorded example of this unique property of semi-conductors.

A humble researcher in pre-WWII Russia, Oleg Losev, reported in detail the light emitting properties of zinc oxide and silicon carbide crystal rectifier diodes (used in radio receivers) when they were subject to an electric current. Losev’s first paper on this was published in 1927 by the journal *Tele-*

*grafiya i Telefoniya bez Provodov (Wireless Telegraphy and Telephony)*. It is reasonable to acknowledge Losev and Round, who can both be recognised as early pioneers in light-emitting-diodes.

Researchers over the following half century experimented with various semi-conductors however in 1962 four research groups reported a functioning *visible source* LED semi-conductor using gallium arsenide crystals. From (two separate) General Electric Company Laboratories came Robert Hall and Nick Holonyak, also Marshall Nathan of IBM and Robert Rediker of MIT. Telescoping through to today, the major milestone of the development of the blue LED ushered in a new era of illuminating the world. This breakthrough was recognized with the Nobel Prize awarded to the developers namely Asaki, Amano and Nakamura in 2014. Blue LEDs, combined with yellow phosphors, allowed the generation of white-light, and being more energy efficient than fluorescent or incandescent lighting, LED lighting is now recognised as the more efficient method for lighting the built environment for the 21st century.

## Light for Health

The case for designing LED lighting to support health and wellness has been accepted into our building standards and design parameters commonly referred to on a daily basis by architects and lighting engineers. The aged-care sector is just one example of where solid-state lighting has been modified to contribute to improved quality of life for residents and more efficient working conditions for staff. It raises the question however, “Have we gone far enough?”.

The retina is populated by light sensitive cells widely known as the rods (for night/s-cotopic vision) and cones (for colour vision

and day/photopic vision). When a photon is absorbed by the photo-pigment within the outer segment of the rod (rhodopsin) it sets in to train a series of reactions that cause hyper-polarization of the rod cell membrane and the issuance of an action potential to the brain via retinal ganglion cells to which they are connected via bipolar cells. The photo-isomerisation of rhodopsin and its associated opsin in cones underpins the elementary initiation of what we ultimately sense as “*vision*”. The opsins must be replenished; and for this the source is Vitamin A, stored in the liver. The process of photo-isomerisation causes metabolic by-products and cellular waste. The platelets of the rods and cones are at least partially shed, typically during sleep.

The metabolic debris is absorbed by the retinal pigmentary epithelium (RPE), the foundation layer upon which the sensory retina sits and into which the tips of the rods and cones are inserted. Over time and from a young age, metabolic waste accumulates within the cells of the RPE- a key waste protein is the flurophore “A2E”. The research performed by a number of investigators [1] reveals that reactive-oxygen-species (ROS), which are damaging to structures within the cell, are generated by high-energy-visible light (HEVL) particularly in the range of blue-violet of 415–455 nm. HEVL poses a threat to retinal health and particularly the macular (the retinal region servicing central vision): over-exposure increases the risk of cell damage to the rod outer segment initiating the cascade of generating ROS followed by cell damage both to the platelets and to the mitochondria within the cell. The cellular debris and degraded photo-isomerised rhodopsin is absorbed into the RPE where it is converted to A2E. Accumulation of A2E within the RPE compounds the problem as RPE cells loaded with A2E are significantly more susceptible to blue-light damage than RPE cells not loaded with A2E [2]. Over time



therefore, the RPE cells also become highly susceptible to blue-light damage which accelerates the development of what in the clinical literature is referred to as “*macular degeneration*” (MD).

**Aged Care**

Those who live in aged-care facilities are most likely to be over the age of 65 years. This population cohort, by virtue of age, will have accumulation of A2E within the RPE and are at elevated risk of developing MD as a consequence of over-exposure to HEVL. MD presents initially as deposition



Figure 1: Observed through the pupil, typical yellowed drusen deposits associated with MD at the posterior pole of the eye

of metabolic waste at the posterior pole of the eye typically seen as macular drusen (see Figure 1), which over time can lead to a cascade of cellular events leading to permanent scarring and loss of central vision. Loss of central vision typically compromises vision for reading, recognising faces and driving a motor vehicle. It is in the developed world, the most common cause of severe visual impairment in people over the age of 40 years.

The Australian Macular Degeneration Foundation reports that 14% of the population have the early signs of MD risk [3] with the classic sign of retinal drusenoid deposits at the posterior pole of the eye. One study of more than 1000 subjects over age 65 years with Asian heritage reports MD in 5% of those aged 65–69 years and 24.4% in those aged over 80 years. The impending sign of MD (soft drusen) was observed in 42.2% of all subjects [4]. A further study conducted in Greenland of the Inuit population studied 695 subjects which revealed the presence of established MD in 43.3% of the population over the age of 80 years. Importantly, the prodromal signs of MD, in this study referred to as “ARM” or “age-related maculopathy”, are concerning at 52.3% [5]. The research to date provides a safe conclusion that a significant number of subjects within our populations over the

age of 65 years either already have MD or have macular drusen which increases the risk of developing MD and visual impairment beyond the age of 80 years.

Given the relative ease with which luminaires can be designed and fabricated for custom applications, certainly in aged care this is one space where LED lighting on the one hand can be deployed to support circadian functions and assist with sleep/alertness at appropriate times of the day but also take into consideration the susceptibility the aged eye has to HEVL. From a clinicians perspective, HEVL should be minimised in the spectral power distribution (SPD) for lighting in occupied areas of aged care facilities in the interest of reducing the risk of exacerbating MD in a susceptible residential population.

**Pre-Schools and Schools**

Pre-school attendance typically begins at around the age of three or four years, although in many countries this can be preceded by “day-care” which can begin at an earlier age. Until 10 years of age, 90% of incident HEVL penetrates the cornea and crystalline lens to ultimately reach the retina. The corollary to this is that as the crystalline lens ages and accumulates chromophores, less blue light is transmitted to the retina. In the earlier years of life therefore, exposure to lighting that contains HEVL will inevitably expose the retina to HEVL and in later years of life, this risks an elevated risk of MD.

The Chesapeake Boatmen Study and the Beaver Dam Eye Study set out to study the effect of solar radiation on eye-health. These studies revealed an association between sunlight exposure and the absence of wearing sunglasses between the ages of twenty to thirty years with MD in later years of life. The Beaver Dam study also ruled out MD and an association with UV light, not surprisingly as less than 2% of incident UV reaches the retina in adulthood. This raised the question of short-wavelength blue light as central to the question on damage to the posterior segment of the eye, later confirmed by others. Many research articles have revealed an association between light skin and eye colour with sun exposure and MD [6], highlighting some phenotypes as more susceptible to short-blue wavelengths. In the context of indoor environments, research by Shang et al (2017) revealed that HEVL from LED sources at levels typically experienced in the built environment of approximately 700 Lux, phased over a 12 hour light/dark cycle, caused marked changes in retinal integrity when exposure to HEVL, measured over days and weeks; importantly, these are not time periods within the range of current standards that apply to LED lighting (IEC 62471). These changes were not observed for longer wavelengths of green or red LED sources (see Figure 2).

In Figure 2: A. Normal retinal layers in control group compared to wavelengths of 620/530/460 nm and induced retinal injuries including absence of photo-receptors

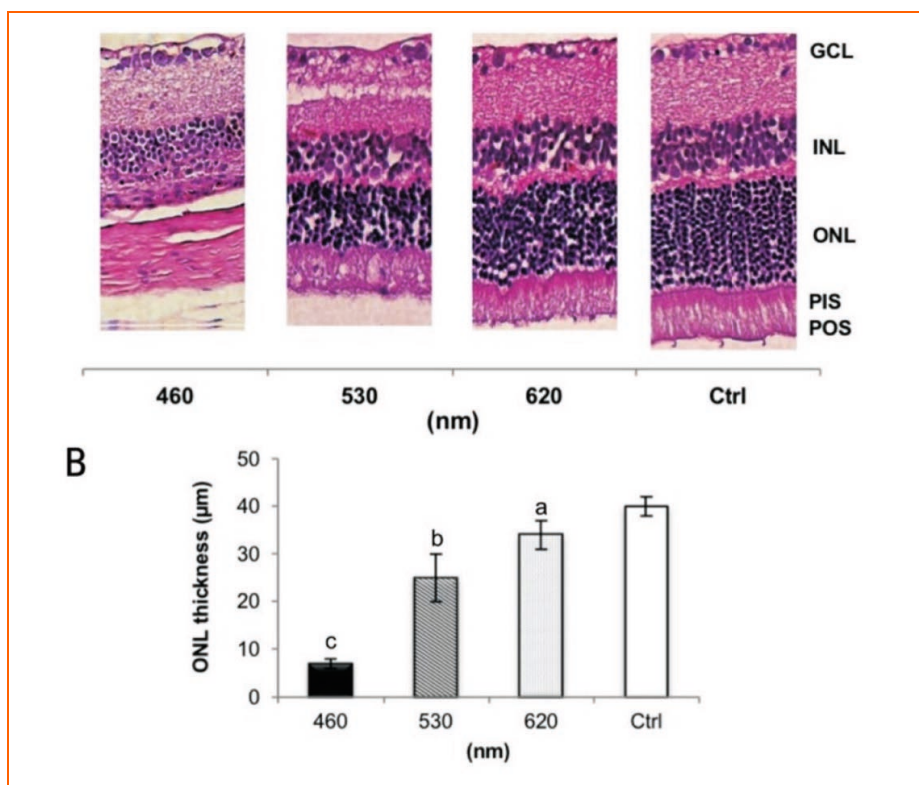


Figure 2: Histology: The image shows blue-light induced retinal pathology; see text below for nomenclature and details

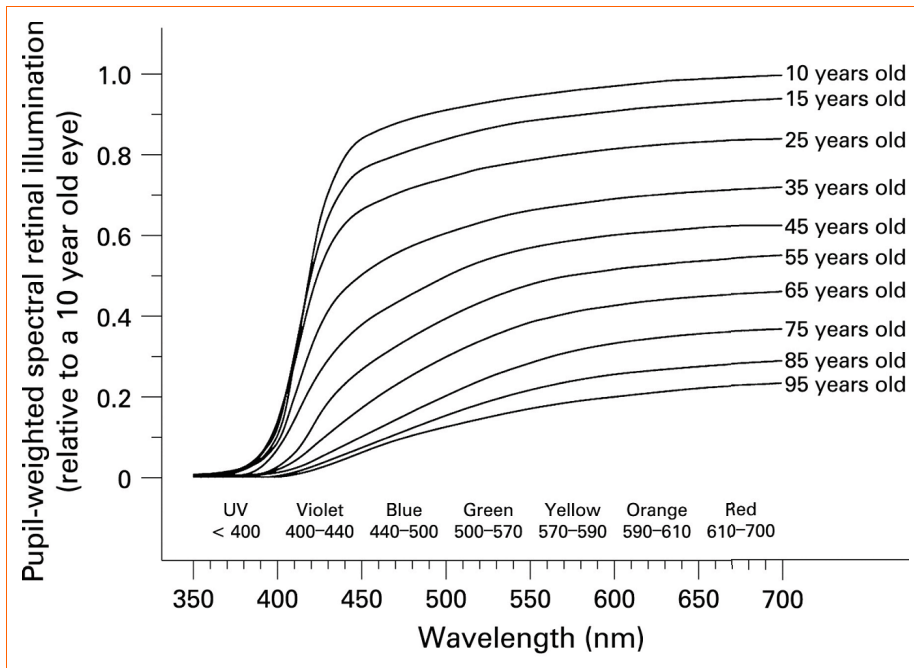


Figure 3: UV and visible light transmission through the human eye subject to age

and INL degeneration; B. The ONL thickness of the exposure groups decreased significantly after 28 d of light exposure. The blue LED group exhibited the strongest loss;  $n=6$  for the control group and  $n=8$  for each exposure group. GCL: Ganglion cell layer; INL: Inner nuclear layer; ONL: Outer nuclear layer; PIS: Photo-receptor inner segment; POS: Photo-receptor outer segment. (Shang et al 2017).

The younger eye transmits more of the shorter blue wavelengths than the ageing eye. As yellow chromophores accumulate in the crystalline lens, beyond the age of about ten years less high energy photons reach the retina. Given the understanding of the impact of high energy photons on the health of the retina, in environments where LED lighting is to be deployed for example in pre-schools, kindergartens and primary schools, care should be taken to minimise the exposure of these age-groups to LEDs with an elevated content of HEVL. **Figure 3** shows a graphical representation of the behaviour of visible light and UV through for various ages.

From **Figure 3**, at age 10 years, 85% of light at 450 nm is transmitted to the retina. For the same wavelength at age 35 years, only 50% reaches the retina. And given that A2E accumulates within retinal structures throughout life, it is essential that LED lighting installed in spaces designed for younger age groups, minimise HEVL. Their risks of macular impairment are otherwise unnecessarily elevated in later years of life.

## Glare and Retinal Stray Light

The LED lighting community is typically aware of the Rayleigh scattering of light through the atmosphere [7]. LED lighting solutions provide a variety of remedies to limit leakage of light from the edge of luminaires and optical solutions to (essentially) control the focus so limiting scattering by the atmosphere of the light leakage lost by luminaires. Increasingly, for out-door applications, it is a topic raised by interest groups concerned about light pollution with reasonable grounds, given the impact on the natural environment for animals and insects (by way of example) notwithstanding the effect on humans and astronomical observers. This section deals with the scattering of light through the eye, with emphasis on the cornea and crystalline lens and also considering stray light within the retina. The cornea and crystalline lens, in obeying Rayleigh scattering, do so proportional to the inverse of wavelength to the fourth power ( $1/\lambda^4$ ) [8].

The human eye has a number of elements that contribute to scattering light. From **Figure 4**, the cornea contributes mainly Rayleigh scattering largely due to water and protein molecules that make up its lamellae of collagen fibres. The crystalline lens contributes mainly Rayleigh-Gans scattering, sometimes called Rayleigh-Gans-Debye (RGB). There is little change with corneal transparency or scattering values with age, however the crystalline lens does exhibit more scattering with age to ultimately suffer from Mie scattering. Mie scattering is less wavelength dependent as it occurs with

particle sizes greater than the wavelengths of the incident light [8].

Clinically, glare is divided into either “*physiological*” or “*psychological*” glare. Physiological glare occurs when light from a source causes the observer to at least partially close the eyes as a protective mechanism to reduce retinal exposure. This may occur when an observer’s direct vision is impinged temporarily by the sun. Psychological glare occurs giving rise to a more severe response requiring the observer to turn away from the source and completely re-direct the visual axis from the direction of the light source. It can typically cause blepharospasm. This may occur in cases of extremely bright light sources directed at the eye or in pathological situations, migraine or some types of ocular inflammation where the sufferer often retreats to a darkened room or is obliged to wear dark glasses even indoors.

In the clinical setting, the term “*flare*” is sometimes used to describe what is experienced subjectively by an observer as an aura of varying shape and intensity surrounding a light source. The source of such entoptic phenomena are typically both the lower order optic aberrations of the eye, which would include uncorrected astigmatism and other ametropias, or the higher order aberrations, a common example is coma. Observers may report an overall “*veil*” that covers the entire visual field, sometimes referred to as “*veiling glare*”. The Commission International d’Eclairage defines “*disability glare*” as “*retinal stray-light*” “*retinal stray-light*” [9]. Consideration of the wavelength dependence of retinal stray light, central to the cause of disability glare emanating from a light source, is an essential consideration in the application of LED lighting.

VandenBerg’s development of improved methods and devices for measuring retinal stray light and its effects [10] confirmed the original hypothesis by Stiles in 1929 that the optical media of the eye closely obeyed Rayleigh scattering through the cornea and Rayleigh-Gans scattering through the crystalline lens. The significant variables revealed by VandenBerg’s work were the subject’s age and eye colour, or more accurately, the degree of pigmentation of the uvea (iris, ciliary body and choroid). Interestingly, less pigmented eyes showed greater scattering effect from longer (red) wavelengths transmitted through the wall of the eye (as a consequence of a lightly pigmented uvea) that had hitherto interfered in the historically less precise methods of measuring for retinal stray light. In addition to eye-wall interference in the retinal image,

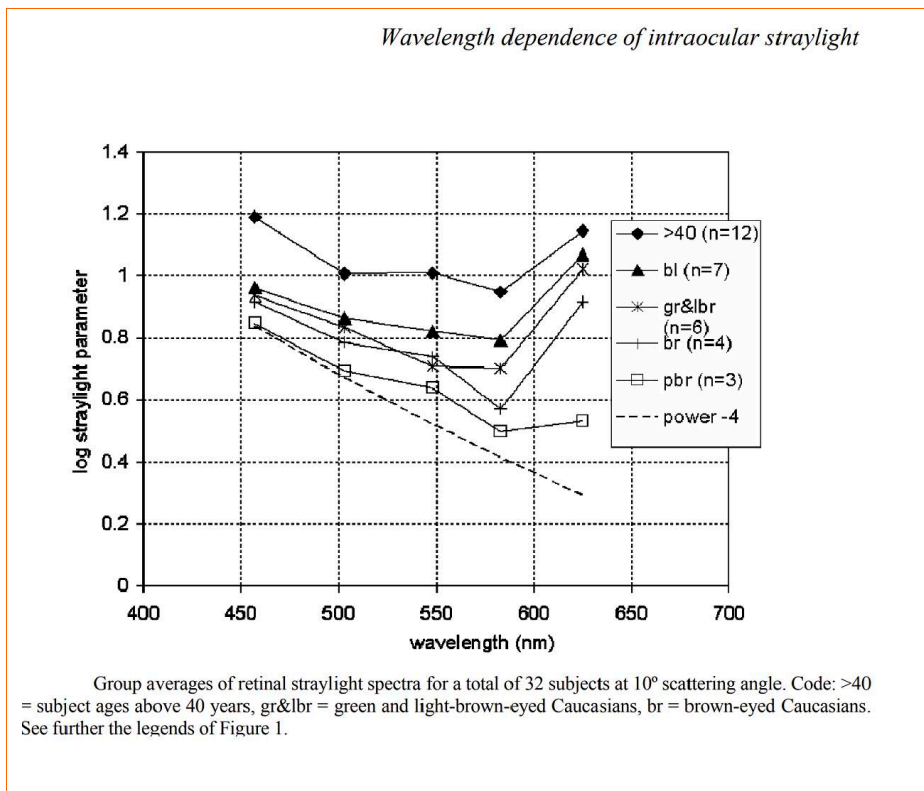


Figure 4: Disability Glare obeys Rayleigh dependence on wavelength

it is interesting to note the back-scatter of longer wavelengths from within the retina when measured at small angles from the visual axis are a function of the transmittance spectrum of haemoglobin, consistent with the highly vascular retina (see **Figure 4**). In certain settings, particularly when it comes to considering the age of a population, the degree of retinal stray light is an important consideration. Minimising short-blue wavelengths contributes to reducing the experience of disabling glare.

A method used by design engineers is use of indirect sources for their applications. Whilst this may not be a practical solution for all projects, it is a solution that can mitigate against retinal stray light with judicious use of surface albedo. In the instance of an LED surface emitting light that is directly visible to the observer, by virtue of the presence of short-wavelength blue light in the SPD of many LED sources (globes and panel luminaires), in the context of Rayleigh Scattering of light through the ocular media, careful consideration needs to be given to the potentially negative visual effects of disability glare.

### The Outliers

In any random cohort of people there is likely to be subjects who do not fit either genotype or phenotype of the average. The paper by Krigel (2016) showed a greater

susceptibility to retinal damage from HEVL for laboratory mammals with less eye pigmentation than those with more. In consideration of the design characteristics of lighting for classrooms (as an example), the susceptibility of the most vulnerable to long term exposure to HEVL should be factored into the short-wavelength blue-light content of the final design.

For the ageing eye, **Figure 3** reveals that at 75 years of age, significantly less HEVL reaches the retina as a consequence of yellowing of the crystalline lens. In developed countries however where the average lifespan is now approaching 80 years and more, a significant proportion of these subjects will benefit from eye surgery to remove cataracts and have a replacement intra-ocular lens (IOL) implanted that replaces their own, which as a consequence of ageing, became at least partially opaque and compromised the visual acuity. Some surgeons may elect to use a yellow IOL which protects the retina from HEVL, but there are no guarantees this will always be the case. Cost constraints may impact the final choice of IOL and it is typically the more expensive IOLs that absorb short wavelength blue light. Some surgeons may be ambivalent about using 'blue-blocking' IOLs. This was apparent in the early years of IOL usage (1980's) where this author had a number of patients undergo highly successful cataract surgery ("20/20" aided acuity) with IOL implants, to see the vi-

sion reduced to "legally blind" within a few months after surgery- the macular was lost to advanced/wet ARMD within a remarkably short period- this at a time when no treatment was available for this pathology as is the case now. It served this clinician as a stark reminder on the powerful relationship between light and retinal health. The lesson from this is that it is not appropriate to assume that as most of the eyes in aged-care for example are over the age of 65 years, their crystalline lens is aged or they have an IOL capable of absorbing short wavelength blue light, therefore HEVL is of no great consequence. HEVL should be considered on various levels which includes not only circadian function but the safety of the retina- some subjects may have high quality IOLs that protect the retina from HEVL and some may not. The design parameters of the lighting needs to accommodate the most vulnerable in the cohort and minimise the risk of retinal harm.

A significant percentage of the aged population suffer from "dry eye". It is the combination of a number of features of the ageing eye and eyelids that ultimately leads to instability of the tear film. An intact tear layer is essential for clear vision. As the air/tear boundary suffers instability as a consequence of either a lipid or aqueous deficiency (or both), visual acuity and visual performance decline. The epithelial cells of the cornea rely on an intact tear film to remain hydrated and to maintain an intact cell wall. With dehydration of the corneal epithelium and loss of cell wall integrity, cells suffer apoptosis and necrosis- cell death. This begins an inflammatory cascade and the release at the cellular level of inflammatory mediators; histamine, serotonin, prostaglandins and cytokines. Release of inflammatory mediators compounds the inflammatory response which disturbs the corneal hydration and leads to an increase in a subjective experience of photophobia and disabling experience of glare. Many, if not most in the population over the age of approximately 70 years have some degree of tear film instability from loss of meibomian gland function and associated loss of tear lipids. Their manifestation of "dry eye" (although typically the eyes suffer from epiphora resulting from elevated aqueous production and lachrymal discharge as a result of chronic irritation) can vary from mild to severe. Most sufferers are intolerant of bright light and any sources of glare. These subjects represent a growing cohort of an ageing population and even more-so in designated aged care facilities and retirement homes. Indoor lighting with elevated content of short-wavelength blue, is contra-indicated in such settings.

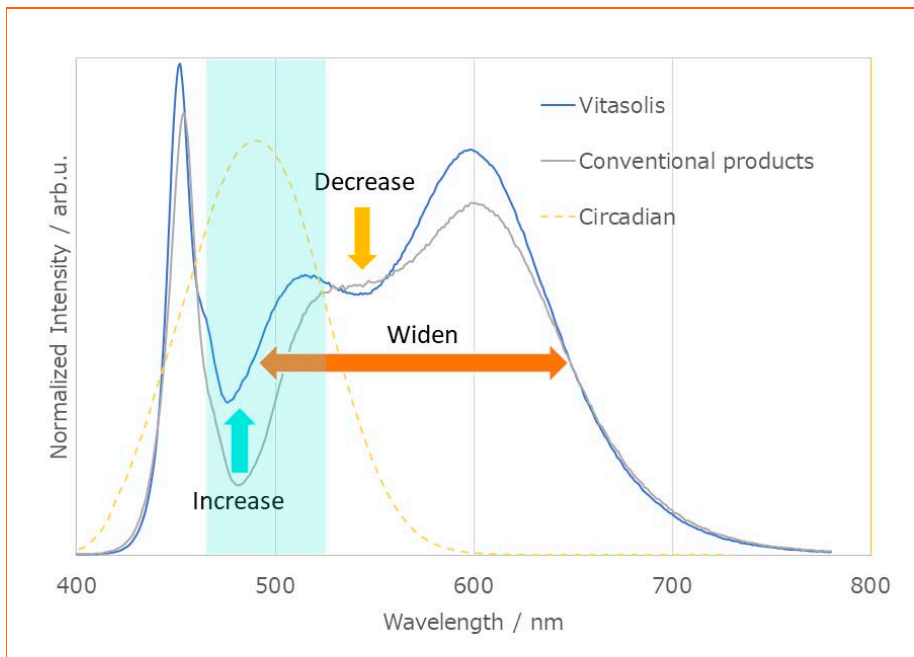


Figure 5: Example of Industry Response to HCL Market: Vitasolis™ by Nichia

## A Practical Application: Novel Spectra for Indoor Lighting – Schools/Offices/Universities; Less Retinal Stray Light and a Healthier Option

A study conducted in Japan and published in 2019 revealed that the prevalence of myopia in Japanese teenagers has now reached 94.9% [11]. Myopia, or “near-sightedness” is the consequence of elongation of the eye-ball, essentially, an eye that loses its innate capacity to control its own growth cycle and grows too long requiring optical correction for clear distance vision. About 10% of sufferers of myopia will have “high myopia” which in old-age leads to significantly increased frequency of vision loss (ocular morbidity). The burden for both individuals and the health costs globally for this problem both now and in coming years is already destined to be very high. Triggering ipRGC/retinal dopamine response controls eye growth and so limits, or can prevent, myopia in the first instance [12]. Research by Hua revealed that by simply making classroom lighting brighter and using fluorescent lighting with wavelengths that fortuitously fell within the melanopic sensitivity function, this more than halved the incidence of juvenile myopia in his study on school children [13]. Modified LED lighting rich in wavelengths that trigger the ipRGC’s, so stimulating the retinal dopamine response, and with reduced short-wavelength blue (415–455 nm) offers a solution for the global epidemic

in myopia whilst also protecting the retina in age-groups where shorter blue wavelengths penetrate to the retina whilst also optimizing visual performance. Some progressive LED manufacturers are beginning to offer such products with increased cyan content and relatively less violet content. An example of such a spectral power distribution could be as per **Figure 5**. We can expect new generation products to follow with even more improvements in the near future that are designed to accommodate eye-health and support of the circadian rhythm.

## So: What Constitutes the ‘Perfect Light’?

As humans become more urbanised, careful thought and design considerations are required to provide lighting solutions that in the first instance are designed to “do no harm”, a central tenet in medicine. Light is now better understood to have impact upon health and well being and as such, needs to be considered in the context of being of potentially therapeutic benefit or not. Lighting solutions ideally should be crafted to be in synchrony with our physical as well as our mental well-being. Illuminating the built environment well, has numerous benefits for man both from health aspects as well as productivity- the two are essentially linked. Whilst it is challenging to provide lighting solutions under the banner of “one-size-fits-all”, there are certain parameters that can be easily addressed that provide immediate support for eye-health; there is little room for high-energy-blue light

that contributes to retinal stray-light and potentially risk to retinal health. And with tunable LED solutions, processor control over wavelength, luminance and time offers a remarkable opportunity to adjust indoor lighting that can be visually comfortable, healthy for eyes and healthy for living by providing concurrent support for both ocular and systemic circadian clocks. *It makes sense therefore that the very source of this benefit, light, should be designed to complement the health of the very organs used for its detection, our eyes. With current technology and tunable solutions, LED lighting offers a solution that can be intelligently prescribed and tuned according to the cohort of subjects for which it is meant to serve, be they: the young in kindergartens, the elderly in aged-care facilities or those who may be the outliers in offices, schools and factories.* ■

## References

- [1] Shang YM, Wang GS, Sliney DH, Yang CH, Lee LL. Light-emitting diode induced retinal damage and its wavelength dependency in vivo. *Int J Ophthalmol* 2017;10(2):191–202
- [2] Arnault E, Barrau C, Nanteau C, Gondouin P, Bigot K, Viénot F et al. (2013) Phototoxic Action Spectrum on a Retinal Pigment Epithelium Model of Age Related Macular Degeneration Exposed to Sunlight Normalized Conditions. *PLoS ONE* 8(8): e71398. <https://doi.org/10.1371/journal.pone.0071398>
- [3] <https://www.mdffoundation.com.au/content/what-is-macular-degeneration>
- [4] Shih-Jen Chen, Ching-Yu Cheng, Kai-Ling Peng, An-Fei Li, Wen-Ming Hsu, Jörn-Hon Liu, and Pesus Chou3 Prevalence and Associated Risk Factors of Age-Related Macular Degeneration in an Elderly Chinese Population in Taiwan: The Shihpai Eye Study. *Invest Ophthalmol Vis Sci*. 2008;49:3126–3133 DOI:10.1167/iovs.08–1803
- [5] Andersen, Mads Varis Nis et al. Prevalence of Age-Related Maculopathy and Age-Related Macular Degeneration among the Inuit in Greenland *Ophthalmology*, Volume 115, Issue 4, 700–707.e1
- [6] Othman Al Gwairi, Lyna Thach, Wenhua Zheng, Narin Osman, and Peter J. Little, “Cellular and Molecular Pathology of Age-Related Macular Degeneration: Potential Role for Proteoglycans,” *Journal of Ophthalmology*, vol. 2016, Article ID 2913612, 7 pages, 2016.
- [7] Bucholz, A. Rayleigh-scattering calculations for the terrestrial atmosphere. Vol. 34, No. 15 *Applied Optics* <https://pdfs.semanticscholar.org/9ca7/810f8cdc348229e262500a88891d2fd93dbe.pdf>
- [8] Vand den Berg, T. Light Scattering in the Human Eye Wavefront Congress Athens,

February 11, 2005 <http://voi.opt.uh.edu/VOI/WavefrontCongress/2005/presentations/3-vandenBerg-LightScattering.pdf>

- [9] Joris E. Coppens, Luuk Franssen, Thomas J. T. P. van den Berg. Wavelength Dependence of Intraocular Straylight. Chapter 8 Experimental Eye Research 82, 688–692. 2006
- [10] Van den Berg, T.J. T.P., Franssen L., Coppens, J.E., Performance of the C-Quant Instrument for Retinal Straylight Assessment Investigative Ophthalmology & Visual Science May 2006, Vol.47, 1220.
- [11] Erisa Yotsukura, MD et al., Current Prevalence of Myopia and Association of Myopia With Environmental Factors Among School children in Japan, JAMA Ophthalmol.2019; 137(11):1233- 1239.doi:10.1001/jamaophthalmol.2019.3103 Published online August 15, 2019.
- [12] Zhou X et al., Dopamine signaling and myopia development: What are the key challenges, Progress in Retinal and Eye Research Volume 61, November 2017, Pages 60-71
- [13] Hua et al., Elevated light levels in schools have a protective effect on myopia, Ophthalmic Physiol Opt 2015; 35: 252–262. doi: 10.1111/opo.12207

#### ABOUT THE AUTHOR



**Stephen MASON, Dr.:** Stephen graduated in Optometry from the University of New South Wales (UNSW) Australia in 1978. In private practice for more than thirty years, for the past decade, Dr Mason has concentrated his interests on the development of LED light that offers beneficial effects for health and visual performance for the human eye and visuo-sensory system. Dr. Mason has been a visiting lecturer at UNSW and became a Fellow of the American Academy of Optometry in 1984. Dr Mason spends the greater part of his time in studying and educating colleagues and stakeholders in the LED lighting community to raise awareness of the importance to the health of our eyes that we adopt best design attributes to illuminate the built environment.



## Sustainable Eye Health Pty Ltd

### An LED IP Company

#### *LED IP that supports:*

- Eye health
- Circadian function
- General health and well-being

#### *Through:*

- Intelligent design of the spectral power distribution
- Processor control over LED output for:
  - Wavelength
  - Intensity
  - Duration

For more information contact:

Founder:

**Dr Stephen A Mason**

*B Optom FAAO Dip OT*

E: [stephenmason102@gmail.com](mailto:stephenmason102@gmail.com)

Web: [sustainableeyehealthptyltd.com.au](http://sustainableeyehealthptyltd.com.au)

# A New Method to Tune an LED Spectrum

Spectral tunable LED is not novel and different principles for different applications can be found on the market. However, following the black body line, or satisfying the requirements on HCL while being efficient is not trivial. Daniel Han, Business Development Director at Beijing Yuji International and his co-authors, Dr. Zhenxiong Wu and Dr. Leo Zhang, propose a new method implemented in their Spectrum X system to separate different but necessary parts from a full white light spectrum into individual channels or packages and adjusting each channel by an electrical circuit. The method promises advantages to match circadian rhythms better due to its relatively higher involvement of the melanopic sensitivity, while the broader spectra avoid dominant peaks especially of the blue light.

**S**PECTRAL tunable LEDs are used in different applications. For instance, in entertainment lighting equipment for stages, which requires saturated blue, green and red to create infinite spectral combinations of color; and for photographic lighting fixtures, the tunable spectrum means simulating tungsten and daylight or other specific natural or artificial lighting environments; for human-centric lighting, the tunable spectrum is the dynamic light for optimizing different scenes that affect circadian rhythm.

## Introduction

This article introduces a new method for a tunable spectrum LED to provide a product solution for flat spectrum tuning. The tuning theory and data are also introduced, and the conversion from the spectral power distributions to Color Rendering Index (CIE 13.3-1995) and TM-30-18 (IES) to present the color rendition performance will also be compared to conventional methods as mentioned. This new method is supposed to be ideal for optimizing human-centric lighting (HCL) solutions, as widely recognized, HCL is not just CCT tuning but is about the essence of a spectrum. Compared to conventional methods, this approach matches circadian rhythms better due to its relatively more involvement of the melanopic sensitivity, and the broader spectra avoid dominant blue peaks, which means it better mimics natural light from

morning to night, providing comfort light on both visual and biological levels. Furthermore, it is not only suitable for HCL, but all applications that demand dynamic and flat-spectrum will also prefer this method. For example, it could simulate standard illuminants of A / B / C / D50 / D55 / D65 / D75 to an ideal degree. Considering the flexibility of the use of semiconductor LED chip and phosphor, the method can also be extended to more spectral elements to match more different and specific lighting applications.

## Background

The digital feature of LED makes it possible to achieve tunable spectrum lighting, and tunable LED is no longer novel for the market. Currently, it is possible to find different solutions with different tunable methods. However, for the applications that require good color quality of uniform spectrum, there are always different problems with conventional methods.

## Conventional Methods of Tunable Spectrum LED

### Full-color tunable LED

A full-color tunable method always comes with pure semiconductor diodes at peak

wavelengths (typical) of 455 nm (Blue), 515 nm (Green) and 630 nm (Red) as frequently mentioned regarding RGB light source. To achieve full-color gamut, or saturated monochrome, the pure semiconductor LED is an ideal solution due to the narrow full width at half maxima (FWHM). No extra wavelengths are involved in the pure semiconductor spectra. Therefore it is easy to get to the edge of the CIE diagram, and the nonlinear tuning feature makes it possible to control the chromaticity coordinates to any color points, including the Planckian locus. But when tuning to white light, there is no color rendition because of its discontinuous spectrum. **Figure 1** indicates the typical RGB spectra with corresponding CRI-Ri and chromaticity coordinates at correlated color temperatures (CCT) of 2879 K and 6535 K (to simulate CIE illuminants A and D65 [1]).

### Hybrid white color-tunable LED

The LED phosphor has become more popular since its birth because of the relatively broader spectrum. The typical full width at half maxima (FWHM) of a pure semiconductor LED is 10–35 nm, while LED phosphor achieves 50 nm - 120 nm. By covering more visible wavelengths ranging between 380 nm and 780 nm, broader phosphor, especially for the ones with a richer red range longer than 620 nm, can offer excellent color rendition. High CRI LED is more widely used compared to five years ago

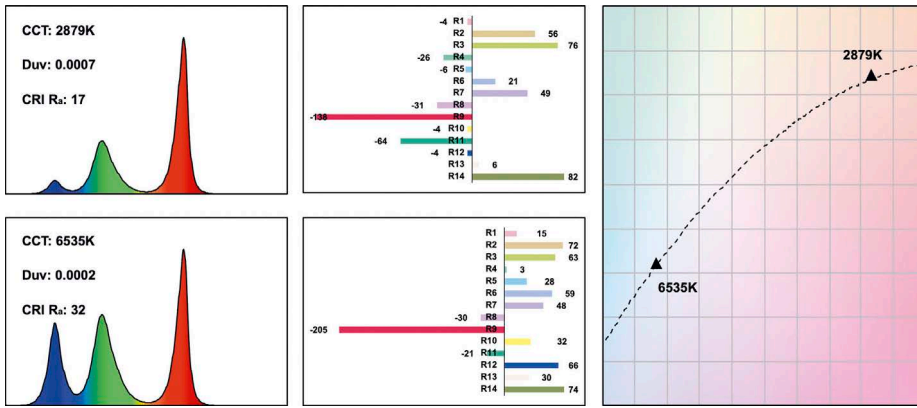


Figure 1: Typical pure semiconductor RGB LED spectra and corresponding CRI-Ri and chromaticity coordinates (CIE 1931)

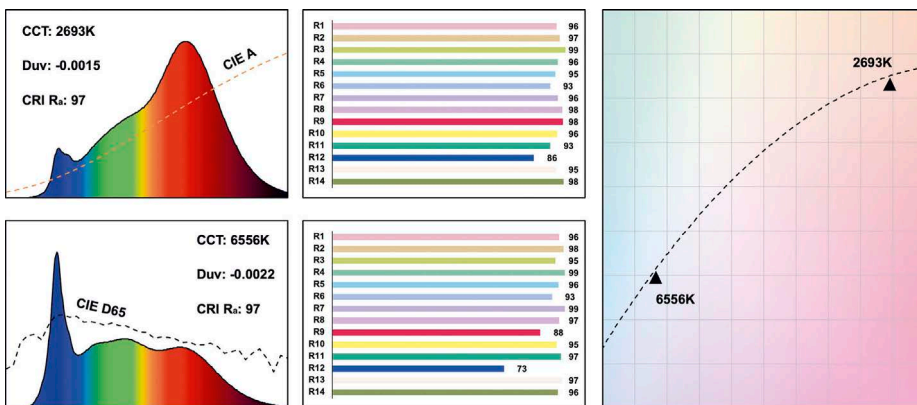


Figure 2: Typical high CRI white LED spectra and corresponding chromaticity coordinates (CIE 1931)

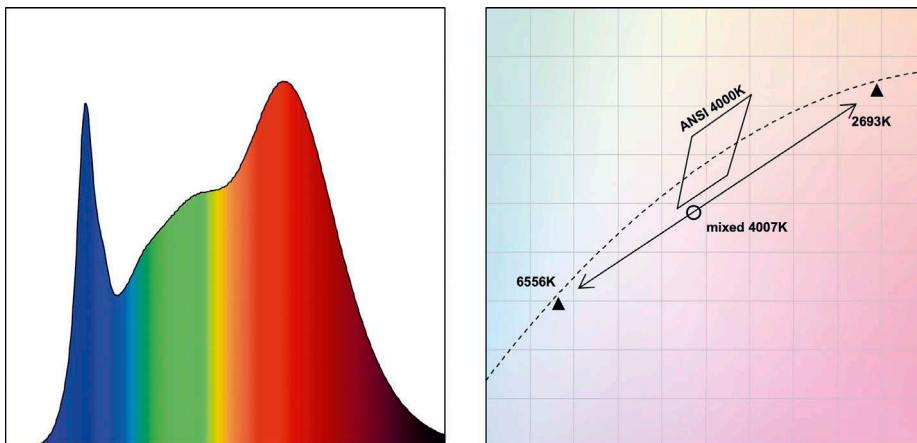


Figure 3: Hybrid high CRI white LED spectra and corresponding chromaticity coordinates (CIE 1931)

since the color quality is concerned more, and the development of high color quality LED is fast.

The independent high CRI LED performs well, however, when mixed with a middle CCT. Due to the linear tuning feature, the chromaticity coordinate can only shift along with the straight line between 2693 K and 6556 K, which results in the deviation from Planckian locus, while for evaluating color

rendition, purest white without any color trends is desired. Figure 3 shows a typical mixing result at 4007K, with the Duv of -0.0083. The magenta tint deviates from pure white, and importantly it is beyond the ANSI C78.377 [2] standard which defines the Duv tolerance of 4000 K as 0.001 +/- 0.006.

Additionally, for phosphor-converted LEDs with a blue chip pumping green/red phos-

phors, or a violet chip pumping blue/green/red phosphors, there is always the accuracy concern in mixing the appropriate proportion of the chip and different phosphors. Tolerance is inevitable. Thus there is the chromaticity bin concept. LED manufacturers (Figure 4) are always trying to achieve as small a bin as possible (Figure 4 shows a comparison between ANSI C78.377 standard and the chromaticity bins provided by some LED manufacturers), but nonetheless, subject to the accuracy of equipment and the cost performance, it is not realistic to shrink the bins to smaller scales within one LED package.

## Introduction to the New Method of the Tunable LED Spectrum

### Theory & Constitute

As well understood, to achieve white light by LED, it is necessary to make the chromaticity coordinates dropped on the Planckian locus or, at least, nearby. The three elements that make up white light are blue, green and red, and none are dispensable. The LED at early stage is constituted by blue chip and yellow phosphors, gradually with the development of LED and phosphor technologies, green and red phosphors replace the yellow phosphor for better color rendition, realizing a wider CCT options simultaneously, and a violet chip exciting blue, green and red phosphor, which means at least 4 elements involved in the white light recipes, is getting popular on the market. Figure 5 explains the basic theory on achieving white light with these different theories.

Apparently, an ideal solution for the spectral tunable method combines the digital feature of the pure semiconductor LED and the high color rendition feature of the phosphor-converted LED. By achieving both flexible chromaticity control and full spectrum that covers most of the visible wavelengths.

The new method comes with:

- Element B: blue phosphor-converted LED with typical peaks at 405 nm and 450 nm, FWHM about 80 nm
- Element G: green phosphor-converted LED with a typical peak at 540 nm, FWHM about 105 nm
- Element A: amber phosphor-converted LED with a typical peak at 605 nm, FWHM about 75 nm
- Element R: red phosphor-converted LED

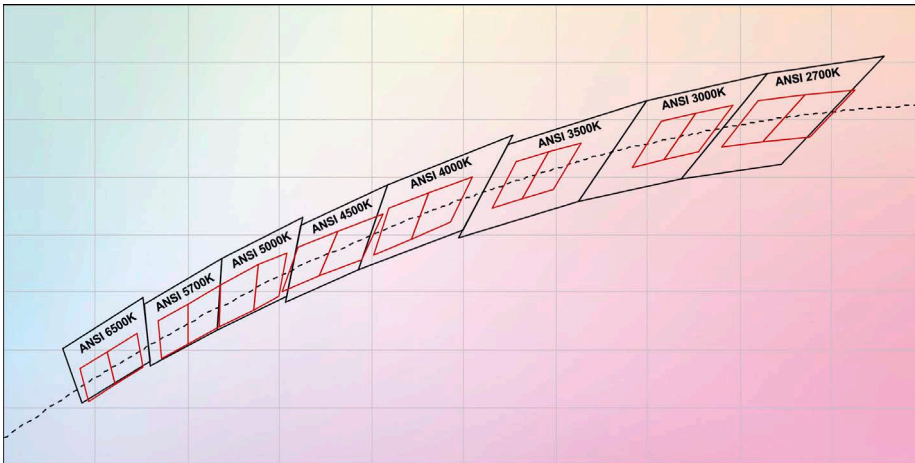


Figure 4: Comparison of ANSI C78.377 chromaticity tolerance with some LED manufacturer's chromaticity bins (CIE 1931)

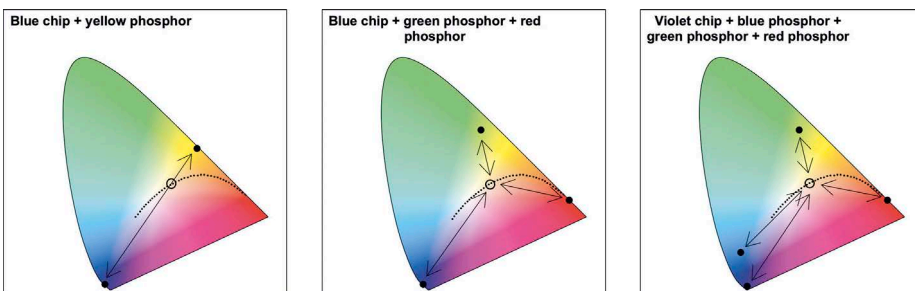


Figure 5: Different theories to achieve white light by LED chip and phosphors

with a typical peak at 665 nm, FWHM about 100 nm

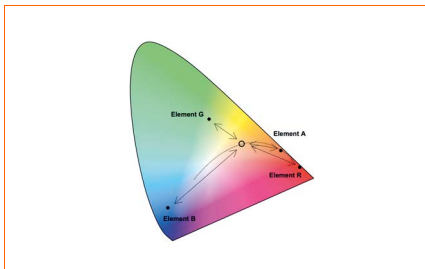


Figure 6: The tuning theory of individual elements of B, G, A and R

A tunable LED system with broad spectra is formulated. The essence of this method is to separate the color elements from a standard white light into individual channels to control. With the flexible and accurate control on each channel, the chromaticity coordinates can be set precisely along with the Planckian locus without the compromise of color rendition. This method avoids the difficulty to mix multiple phosphors in one package evenly, while the accuracy of the electrical system is easier to achieve compared to chemical and optical methods. **Figure 6** indicates the tuning theory of this method by elements B, G, A and R.

The use of each element in **Figure 6** is considered as:

- Element B: constitutes blue energy for white light, helps with chromaticity tuning and color rendition
- Element G: constitutes green energy for white light, helps with chromaticity tuning and color rendition
- Element A: fills the gap between element G and R to help with color rendition
- Element R: constitutes red energy for white light, helps with chromaticity tuning and color rendition

### Test & Performance

The tuning demonstrations aim to simulate natural light spectra as far as possible, achieving excellent color rendition including accurate chromaticity coordinate distributions on the Planckian locus. By tuning the 4-element channels with high accuracy power supplies, the demonstration of the data is formed from 2000 K to 10 000 K, which covers the most frequently used white light CCTs with 77 groups of spectral power distribution, the interval of typical 100 K.

#### Spectral power distribution & Chromaticity coordinate

**Figure 7** indicates the gathering of spectral power distributions and the chromaticity coordinate locus along with the Planckian

locus. The average Duv is 0+/-0.00002 with maximum Duv = 0+/-0.0008. It can be concluded that this method provides pure white light without color deviation at all CCTs.

#### Color rendering index / TM-30-18

For the dynamic spectrum, a typical/average color rendition metric is evaluated, and the maximum and minimum values which stand for the consistency are important and should be evaluated as well. In this report, the metrics of the Color Rendering Index (CRI) from CIE 13.3-1995 [3], and TM-30-18 [4] from IES are tested. **Figure 8** indicates the aggregate tables of R1 – R14 results of CRI, and Fidelity Index and Gamut Index of TM-30-18. According to the statistical data, the average CRI – Ra is 92, for the strong red color rendition of R9, the average is kept at 94. For all R1 – R14 results, the distribution represents a relatively stable trend, which means the color rendition evaluation based on CRI calculation is stable. Calculating with TM-30-18 metric, the Fidelity Index (Rf) and Gamut Index (Rg) perform even more stable. It can be seen that Rf distributes within the range of 90–95 and Rg distributes within 98–102.

#### Spectrum comparison with general high CRI lighting at specific CCTs

Compared to standard and fixed CCT high CRI LED lighting for three typical CCTs – 2700 K of halogen, 4000 K of commercial indoor lighting, and 6500 K of daylight as examples, this method provides more even and uniform spectral power distributions.

Simulation conditions and comparisons for these examples:

- Assuming to achieve 100 lumens on each CCT, then according to the formula of luminous flux the radiant power (W/nm) is derived reversely [5]

$$\phi_\nu = Km \cdot \int_{380}^{780} \phi_e(\lambda) \cdot \nu(\lambda) \cdot d\lambda \quad (1)$$

- Draw the spectral power distributions of the same CCT in the same coordinate system, the X-axis is the wavelength (nm), and Y-axis is absolute intensity (W/nm)
- The difference in intensity at typical 450 nm can be observed significantly

Compared to the standard high CRI LED, this new method brings a typical reduction of the intensity at 450 nm as 58%, 45% and 34% at 2700 K, 4000 K and 6500 K respectively, and the spectrum is distributed uniformly. With the extra 400–430 nm portion, this new method brings a full spectrum in the visible wavelength range.



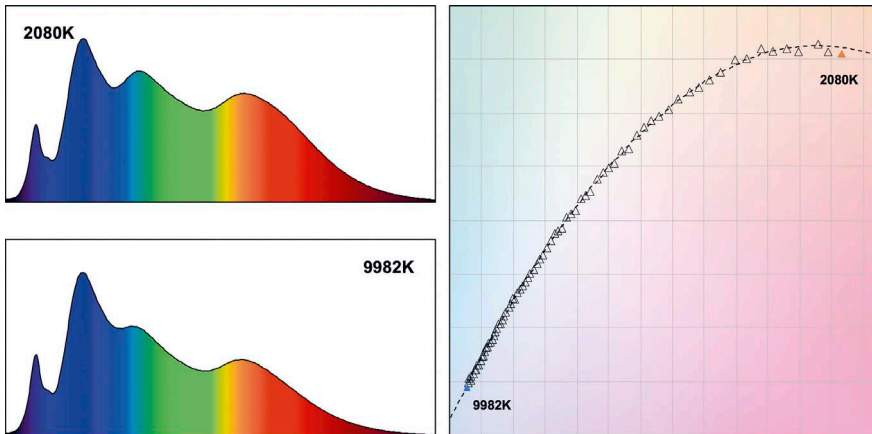


Figure 7: Spectral power distributions and chromaticity coordinate locus from 2000K to 10000K, interval 100K

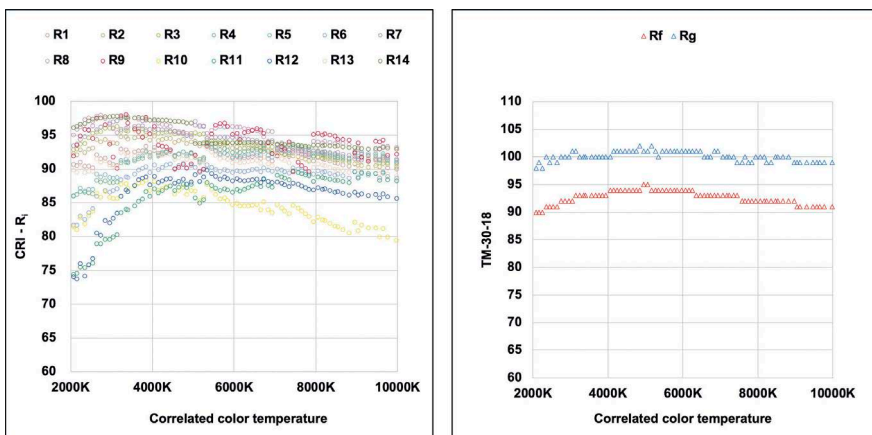


Figure 8: Distributions of different color metrics at different CCTs

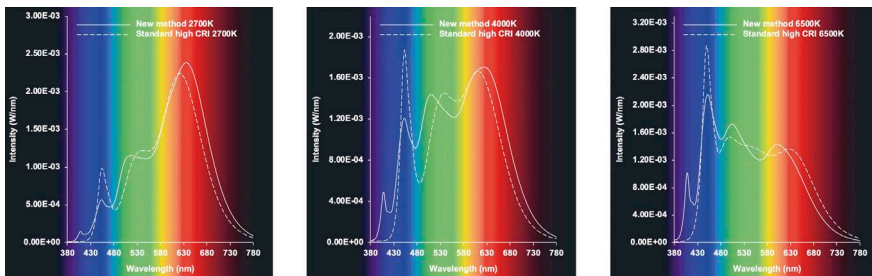


Figure 9: SPD comparisons of the new method and standard high CRI LED

### Optimization for matching with the melanopic sensitivity

The intrinsically photosensitive retinal ganglion cells (ipRGC) are recognized as non-visual photoreceptors but are crucial factors that affect the circadian rhythm biologically. Unlike the photopic (peak 555 nm) and the scotopic (peak 507 nm) sensitivities, the peak sensitivity of melanopsin is the shorter wavelength at 490 nm (Figure 10) [6]. The calculation of melanopic effective watts is similar to the photopic effective watts, just different sensitive weighting involved in the calculation:

$$M(S) = \int S(\lambda) \cdot M(\lambda) \cdot d\lambda \quad (2)$$

The spectrum which is involved in the melanopic sensitivity results in suppressing the production of melatonin.

The spectrum that is involved in melanopic sensitivity results in suppressing the production of melatonin and the consensus is that for work and study time, or environment, concerning the improvement of productivity, the production of melatonin should be suppressed for maintaining alertness. In contrast, the melatonin is supposed to be excreted normally or even more sufficiently during relaxation or at bedtime.

Based on this principle, Figure 11 indicates the spectral comparisons with an optimizing melanopic solution for matching with circadian rhythm, normalized to 1. Relatively, the weighting in the sensitivity is less for the “Melanopic optimized 2700 K” compared to the standard high CRI 2700 K, and is more for the “Melanopic optimized 6500 K” compared to the standard high CRI 6500 K. according to the calculation of Equation (2), the  $M_{2700K}(S)$  is 71% weighting compared to high CRI 2700 K, and the  $M_{6500K}(S)$  is 163% than the high CRI 6500 K.

Additionally, it should be noted and emphasized that there are other factors like intensity and exposure time, which are also crucial conditions that stimulate the circadian system effectively. These are not discussed in this article since the topic is mainly on the spectral characteristics.

### Specific simulations of CIE illuminant D50 and D65

Besides the capability of controlling the chromaticity coordinates exactly on the Planckian locus, it is also flexible enough to set specific coordinates. Taking the most frequently used standards of CIE D50 / D65 as an example, for CIE D series illuminant, the chromaticity coordinates are on the “Daylight locus” with  $Duv = +0.003$  instead of on Planckian locus, then it is still

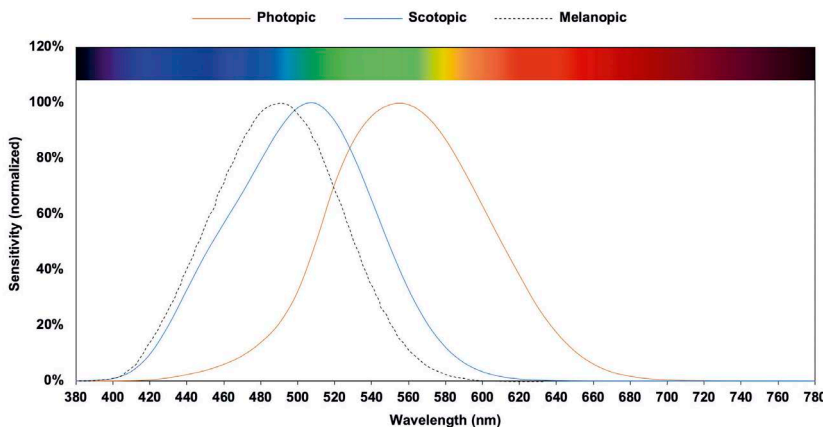


Figure 10: Comparisons of photopic, scotopic and ipRGC sensitivities

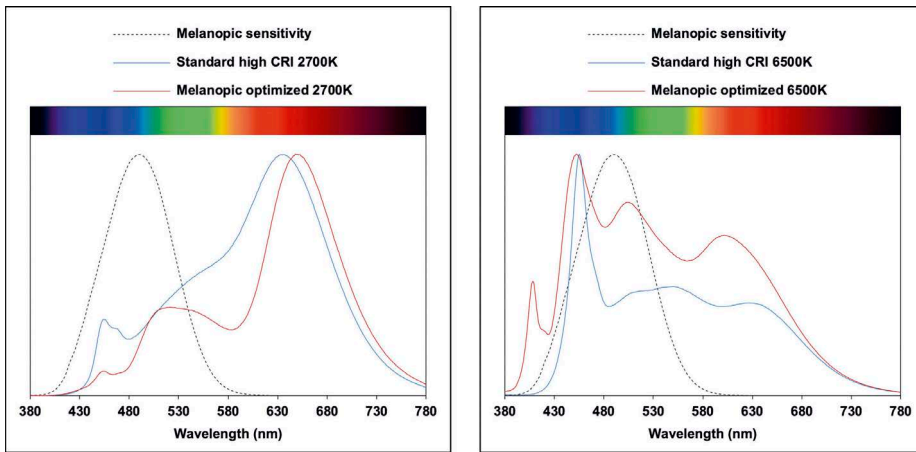


Figure 11: The comparison of melanopic optimized and standard high CRI spectra

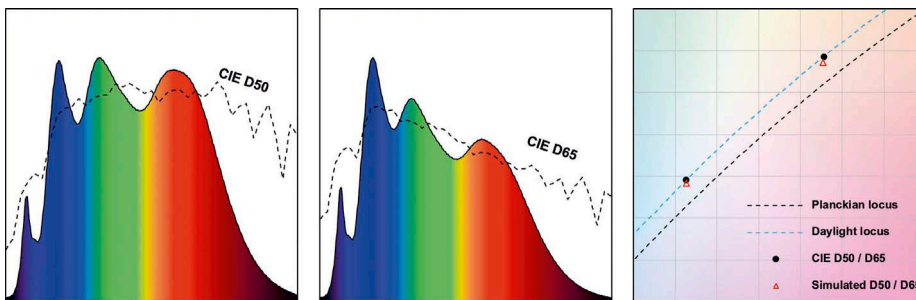


Figure 12: Simulations of CIE D50 and D65

	Forward current (mA)	Forward voltage (V)	Luminous flux (lm)	Luminous efficacy (lm/W)
Element B	120	3.1	20	54
Element G	32	2.7	20	231
Element A	60	2.7	20	123
Element R	300	3.1	20	22

Table 1: Photoelectric parameters and integrated efficacy on 2700K and D65 simulations

	2700K simulation		D65 simulation	
	Relative proportion	Integrated efficacy	Relative proportion	Integrated efficacy
Element B	6%	108 lm/W	42%	111 lm/W
Element G	26%		27%	
Element A	29%		19%	
Element R	39%		12%	

Table 2: Continuation to Table 1

realizable by adjusting the relative proportion of elements B, G, A and R. **Figure 12** indicates the simulated D50 and D65 spectra with corresponding chromaticity coordinates. Through this specific simulation, it can be concluded that this method brings the flexibility of simulating different target chromaticity coordinates by integrating and adjusting the four channels, not limited to the Planckian locus. Theoretically, any coordinates within the trapezoid which are composed of the four elements on the CIE diagram are achievable.

### Luminous efficacy

This method contains four different color elements. **Table 1** and **Table 2** indicate the basic photoelectric parameters when balancing all elements at the same luminous flux of 20 lumens. Because of different distances between the spectra of elements B/G/A/R and luminosity function with 555nm peak, the element R is the lowest efficacy, then B, A and G. For constant luminous flux at all available CCTs, the weakest element, R, is considered and programmed as the highest output LED, and other elements are compromised on it.

When simulating different CCTs' spectra, the relative proportions within the four elements are adjusted accordingly. At typical 2700 K and D65 spectra, the integrated luminous efficacy achieves 108 lm/W and 111 lm/W.

## Application

As introduced with the test and performance, this new method of spectral tuning LED provides the flexibility of formulating uniform and flat spectra, which makes it suitable for matching with the human-centric lighting (HCL) concept. There are misunderstandings with HCL. Like that sometimes it is recognized as just CCT tuning. However, CCT is the calculation from spectral power distribution, and according to the theory of metamerism, the same CCT could be calculated by different spectra. Thus CCT tuning is the result of HCL optimization but not the reason, and the spectrum tuning should be more concerned. This method achieves a balance of color rendition, luminous efficacy, the complexity of the tuning system, CCT tuning range and feasibility. By reducing the 450 nm peak intensities, this method optimizes photobiological comfort, with the full spectrum feature at any CCT. It is also an ideal light source for simulating the sunlight. Additionally, with the flexibility of adjusting the chromaticity coordinates in a wide range, this method is also suitable for simulating specific color points. Color measurement, graphic design, image capture and machine vision, which also require a dynamic lighting environment and good color rendering, are the target applications for this spectral tuning method.

## Challenge & Question

### Electrical accuracy

During the test, it is found that to achieve accurate chromaticity coordinates, either along the Planckian locus or Daylight locus, an accurate forward current is necessary. In the test, interval 100 K CCT from 2000–10 000 K means 1% accuracy tuning on each element, calculating to forward current which is indicated in **Figure 11**, for element G. The current accuracy should achieve 0.32 mA, even if the electrical tuning is generally better than chemical and optical methods, it is still not sure if an electrical system can reach such accuracy, especially when considering the feasibility of economy for commercial use.



Figure 13: An example of the spectrum design system

### Instrumental error

Assuming it is possible to achieve excellent electrical accuracy on both technical and economic feasibilities, there is still a question of instrumental error. According to the test data, with interval 100 K CCT tuning, the chromaticity coordinate of CIE x, y can be adjusted as interval 0.0002 minimally, and it is already close or beyond the instrumental error, thus it is difficult to identify if the test result is convinced and accepted by anyone. This also leads to doubt of the meaningfulness of such accurate tuning.

### Expansion & Summary

In this report, only one method is introduced for the flat spectrum and good color rendition. As a matter of fact, when expanding to more methods to achieve spectral tunable LEDs, there will be many different solutions of combing different LED chips and phosphors. **Figure 13** shows an example of a spectrum design system [8] with the collection of all feasible LED spectrum data in the world. In this case, any feasible tunable spectrum can be designed directly for matching different applications.

In this report, color quality during the tuning progress is considered as a priority. Since the birth of the LED, people have gone from monochromatic of pure semiconductor LED and phosphor-converted white

light LED to the present high CRI LED and spectra tunable LED. It is undisputed that with the development of technology and civilization, high color quality tunable LED is the tendency and future. Popularization is only a matter of time. ■

### References

- [1] CIE 015:2018, Colorimetry, 4th edition. Commission Internationale de L'Eclairage, 10/01/2018
- [2] ANSI C78.377-2017, American National Standard for Electric Lamps - Specifications for the Chromaticity of Solid-State Lighting Products. American National Standards Institute, Inc., 23/05/2017
- [3] CIE 013.3-1995, Method of measuring and specifying colour rendering properties of light sources. Commission Internationale de L'Eclairage, 01/01/1995
- [4] ANSI/IES TM-30-18, IES Method for Evaluating Light Source Color Rendition. Illuminating Engineering Society, 25/06/2018
- [5] CIE 084-1989, Measurement of luminous flux. Commission Internationale de L'Eclairage, 01/01/1989
- [6] CIE S 026/E:2018, CIE System for Metrology of Optical Radiation for ipRGC-Influenced Responses to Light. Commission Internationale de L'Eclairage, 12/01/2018
- [7] Sam Berman, HFIES Senior Scientist Emeritus Lawrence Berkeley National Laboratory, Robert Clear, FIES Staff Scientist (Retired) Lawrence Berkeley National Laboratory, Simplifying Melanopsin Metrology. Illuminating Engineering Society, 31/07/2019

[8] Spectrum Customization, <https://www.yujiintl.com/custom-spectrum.html>. Beijing Yuji International Co., Ltd, 01/12/2019

### ABOUT THE AUTHOR



**Daniel HAN:** With a technical background in photoelectricity, Daniel is currently the business development director at Beijing Yuji International. He is focused on market research, R&D of innovated LED technologies and products, as well as global business strategies implementation. With a profound understanding of the LED technology and extensive experience in different LED industries, Daniel leads a business department mainly concentrating on utilizing and optimizing its expertise and resources to provide comprehensive solutions for various applications and markets.

# LED Lighting for Circadian Entrainment

Since the introduction of LED lights, a lot has been said about risks of blue light for ocular health on the one hand, and the opportunity of circadian entrainment, on the other hand. While a controversial discussion on the first topic is ongoing, the second topic is well accepted. To solve both issues, Bill Chan, President of LiteController Inc. proposes the application of 465-470 nm pumped phosphor converted white LEDs with a content of 86-92% blue-turquoise light and 8-14% blue-violet light. In the article he concentrates on the second topic and proves the benefit of regulating the circadian entrainment more efficiently, maintaining a high typical efficacy of 150 lm/W and good color rendering of CRI 80+ ideally supporting the WELL Building Standard

**L**IGHT plays a vital role in our daily life. Besides helping us with visual effect, light also has important non-visual biological effects on the human body. Good human-centric lighting provides positive influence on health, alertness, well-being, and even sleep quality.

During daytime, sunlight plays the most significant part in regulating the Circadian Rhythm of human body. Nowadays, people are spending more and more time indoors during the day, and thus the time of the eyes being exposed to blue-enriched sunlight is reduced. The average noon daylight in North America and Europe can be represented by the CIE D65 illuminant, as shown in Figure 1. Eye exposure to appropriate amounts of sunlight during the daytime is healthful, and it helps cognitive function, elevates moods and synchronizes body-clock.

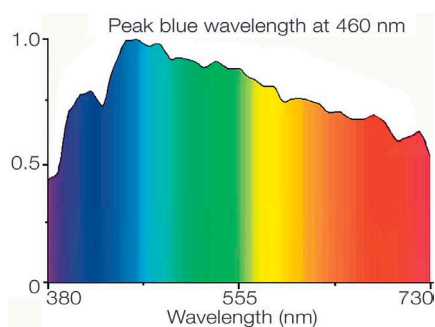


Figure 1: Relative Spectral Power - CIE D65 Illuminant

## Sunlight and Blue Light

Medical studies have shown that blue light in the nighttime suppresses the body to secrete Melatonin (a.k.a. Sleep Hormone), which is required for a good night's sleep. Consequently, our natural sleep-wake cycles can be disrupted by excessive exposure to blue light during the night. So, we should avoid our eyes exposed to bright blue-enriched artificial lighting and electronics screens before going to bed. Disruption of natural sleep-wake cycles may be linked to depression, diabetes and obesity.

Brainard et al. [1] has shown that blue light is the most potent wavelength range to influence the circadian entrainment by suppressing Melatonin secretion, and the quantum sensitivity peaks at 464 nm. Thapan et al. [2] also shows similar findings.

## Circadian Entrainment

Equivalent Melanopic Lux (EML) metrics is adopted by WELL Building Standard v2 to assess the circadian entrainment of the lighting environment. This metrics transforms the amount of light entering the cornea at a vertical pane into an EML value, and this EML value is weighted to the spectral response of the ipRGC cells in the retina. EML metrics is based on the SPD (Spectral Power Distribution) and Circadian index (or also known as Melanopic Sensitivity) of individual wavelength to come up with the Melanopic Ratio. The

EML value is equal to the product of the vertical illuminance and the Melanopic Ratio. The Circadian index used in the calculation of Melanopic Ratio is shown in Figure 2, and it starts to rise from 0.0795 (at 415 nm) to 0.6297 (at 455 nm) and then to 1 (at 490 nm). It demonstrates that blue-turquoise light (456–490 nm) is more efficient than blue-violet light (415–455 nm) to regulate the circadian entrainment. After that, the Circadian index starts to decline and reach 0 at 660 nm, i.e., red light wavelength.

## Retinal Blue-Light Hazard - IEC/EN 62471

Apart from the influence on circadian entrainment, blue light also has another biological effect on the eyes. The details are illustrated in the standard IEC/EN 62471 (Photobiological safety of lamps and lamp systems). The Retinal Blue-Light Hazard stated in IEC/EN 62471 is related to the Photoretinitis, i.e., photochemical retinal hazard caused by high-energy incident light to instigate damage in the retina. Its quantifying parameter is  $L_B$  (Retinal Blue Light Radiance), which determines the LED to fall into which risk group of Blue Light Hazard. There are four risk groups having different limits of  $L_B$ , and for example, Exempt Risk Group specifies a  $L_B$  limit of  $100 \frac{W}{sr \cdot m^2}$ .

$L_B$  is the sum of products of  $L_\lambda$  (spectral radiance) and  $B_\lambda$  (blue light hazard sensitivity) at each wavelength.  $B_\lambda$  curve shown

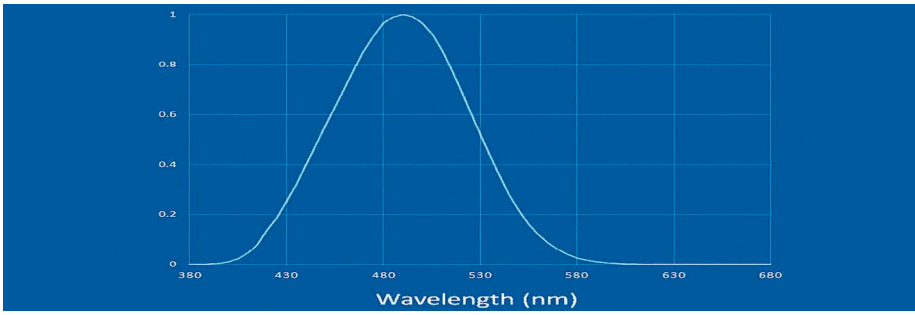


Figure 2: Circadian index @WELL Building Standard

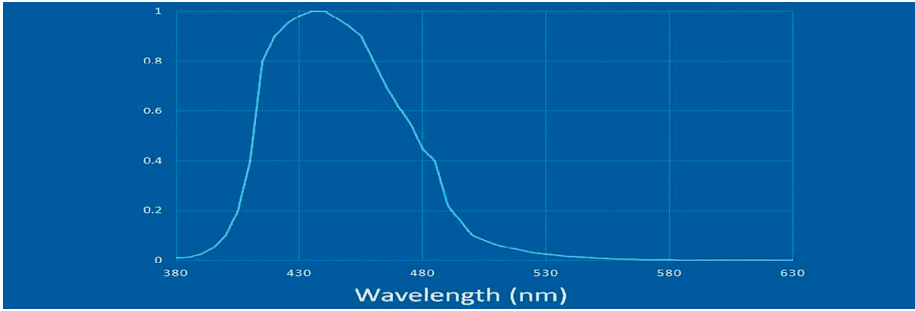


Figure 3:  $B_{\lambda}$  - Blue Light Hazard Sensitivity @IEC/EN 62471

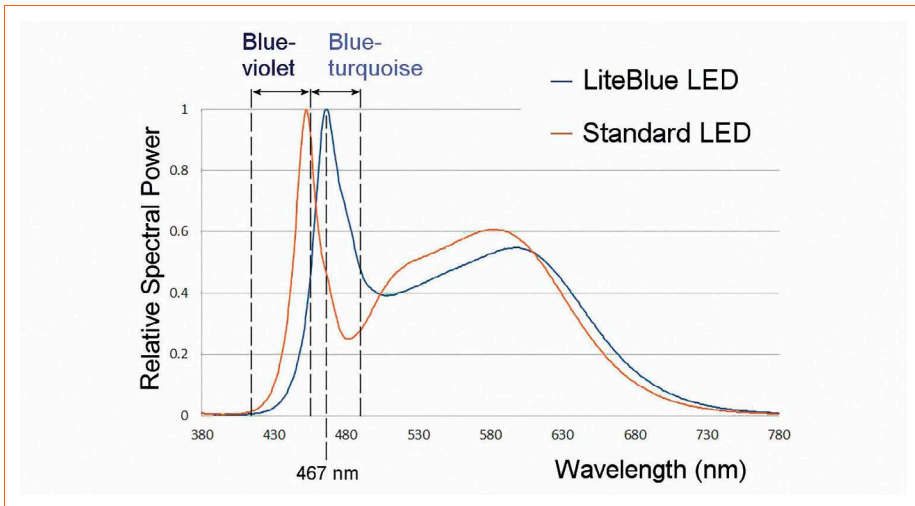


Figure 4: Comparison of SPD between LiteBlue LED's and Standard LED's

in **Figure 3** rises sharply from 400 nm and peaks at 435 nm and 440 nm. It demonstrates that the blue-turquoise light will produce lower  $L_B$  than the blue-violet light. After that,  $B_{\lambda}$  gradually declines to negligible value at 550 nm.

### Blue-violet Light and Blue-turquoise Light

Blue light (415-490 nm) consists of two components, i.e., blue-violet light (415–455 nm) and blue-turquoise light (456–490 nm). Based on the sensitivities illustrated in **Figure 2** and **Figure 3**, a higher dosage of blue-turquoise light is always preferred to blue-violet light for indoor lighting dur-

ing daytime, because of the following two advantages,

- Higher EML (Equivalent Melanopic Lux) to improve the efficiency of regulating the Circadian Rhythm
- Lower  $L_B$  (Retinal Blue Light Radiance) can be achieved

### LiteBlue LED vs Standard LED

Standard LED of 440–450 nm blue pump emits a mixture ratio of blue-violet light and blue-turquoise light by 0.5:0.5 roughly, depending on the color temperatures. By shifting the wavelength of blue pump to

465–470 nm, LiteBlue LED emits a mixture ratio of blue- violet light and blue-turquoise light by 0.1:0.9 roughly, and their mix percentages are listed in **Table 1**. As a result, LiteBlue LED has the advantages of higher efficiency of EML to regulate Circadian Rhythm, and at the same time,  $L_B$  can also be lowered significantly.

### Benefits of LiteBlue LED

Taking 5000 K CCT color temperature as an example, LiteBlue LED emits about 86% blue-turquoise light and 14% blue-violet light. The SPD comparison of LiteBlue LED with a standard LED is shown in **Figure 4**. It shows that the standard LED emits half of the blue-turquoise light content of Lite-Blue LED, and at the same time, three times more of blue-violet light content.

The comparison of LiteBlue LED with sample standard LED in terms of EML and  $L_B$  is shown in **Table 2** for various color temperatures, and they all have a footprint of 2835. Because of its higher content of blue-turquoise light, LiteBlue LED emits 26% more EML than standard LED. Hence, LiteBlue LED can achieve equivalent circadian entrainment at a lower light intensity level. In other words, LiteBlue LED offers the advantages of saving energy and reducing eye discomfort to users, when higher light intensity level of standard LED is used. Also, about 20% reduction of  $L_B$  can be achieved because of the blue-turquoise light enriched spectrum being less sensitive to  $B_{\lambda}$ , when compared with standard LED.

### Luminous Efficiency and CRI of LiteBlue LED

LiteBlue LED offers satisfactory performances in Luminous Efficiency and CRI, which are of 150 lm/W and minimum 80% respectively. Assuming 85% efficiency of optic and driver, LiteBlue LED can meet the minimum requirement of 125 lm/W and 80% CRI for indoor troffer as specified by the DLC (DesignLights Consortium) Premium requirement. DLC Certification is an energy rebate program from the U.S. and Canadian governments to encourage the use of LED lighting products. In the latest version of DLC V4.4, the requirements of Troffer are listed as follows [3]:

- DLC Standard requirement for troffer – Efficacy of 100 lm/W and 80% CRI and above
- DLC Premium requirement for troffer – Efficacy of 125 lm/W and 80% CRI and above

Part Number	CCT	Blue Light Content <sup>1</sup>	Blue-Violet <sup>2</sup>	Blue-Turquoise <sup>3</sup>	Ratio <sup>4</sup>
LB2835-50-465	5000 K	27%	14%	86%	0.1:0.9
LB2835-40-465	4000 K	21%	13%	87%	0.1:0.9
LB2835-30-465	3000 K	13%	8%	92%	0.1:0.9

## Notes

<sup>1</sup>Blue Light Content is the percentage of blue light out of total spectral power of visible light spectrum.

<sup>2</sup>Percentage of Blue-violet Light within the Blue Light Content.

<sup>3</sup>Percentage of Blue-turquoise Light within the Blue Light Content.

<sup>4</sup>Mixture ratio of Blue-violet light and Blue-turquoise light within the Blue Light Content.

Table 1: Blue light content of LiteBlue LEDs

Part Number	CCT	Equivalent Melanopic Lux (EML) Melanopic Ratio (MR)			$L_B$ Increase / Decrease
		LiteBlue LED	Sample LED	Increase / Decrease	
LB2835-50-465	5000 K	1.027	0.816	+26%	-20%
LB2835-40-465	4000 K	0.837	0.675	+24%	-20%
LB2835-30-465	3000 K	0.647	0.514	+26%	-24%

Table 2: Comparison of EML and Retinal Blue Light Radiance  $L_B$  of LiteBlue LED's with sample standard LED's

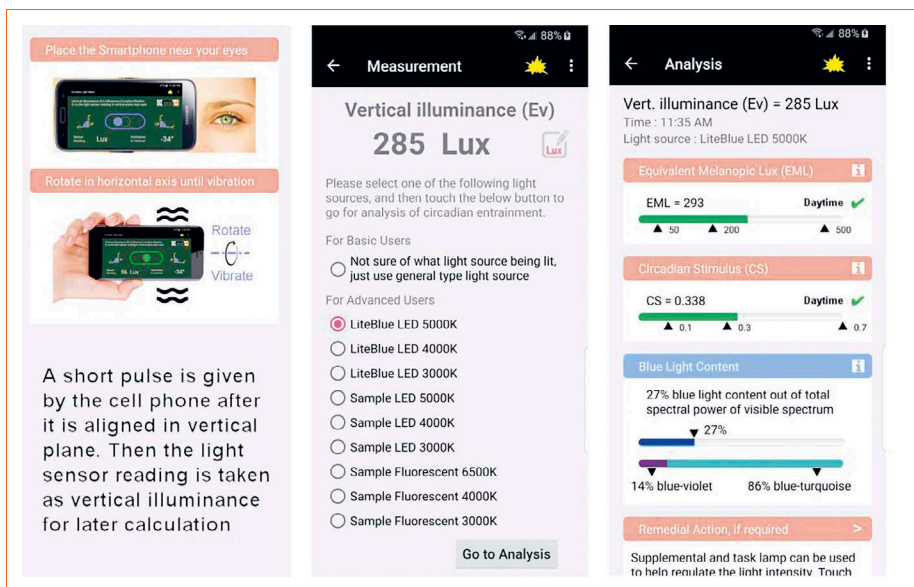


Figure 5: User interface of Circadian Light Meter app

## Android App – Circadian Light Meter

Different workstations inside the office premises may experience different circadian entrainment, especially for those sitting inside a cubicle. In order to facilitate its assessment at a specific position of the office worker, an Android app called “Circadian Light Meter” has been developed for free download [4]. This app makes use of the light sensor and accelerometer of the Android phone to determine the vertical illuminance, after the user aligns his/her cell phone vertically near the eyes. Then the circadian entrainment is calculated ac-

ording to two different metrics, namely, Equivalent Melanopic Lux and Circadian Stimulus. The Android app's user interface is shown in **Figure 5**.

## Conclusions

While there may be still some research required to come to an optimal solution in all LED lighting applications, the required technology to improve LED lighting to become healthier is available and some studies indicate the benefit of the proposed solution. As even very stringent lighting standards are satisfied with this solution, why should we wait longer? Why shouldn't we apply it immediately? ■

## References

- [1] Action spectrum for melatonin regulation in humans: evidence for a novel circadian photoreceptor, Brainard GC et al., J Neurosci. 2001 Aug 15;21(16):6405-12
- [2] An action spectrum for melatonin suppression: evidence for a novel non-rod, non-cone photoreceptor system in humans, Thapan K et al., J Physiol. 2001 Aug 15;535(Pt 1):261-7
- [3] <https://www.designlights.org/solid-state-lighting/qualification-requirements/technical-requirements/>
- [4] <https://play.google.com/store/apps/details?id=com.litecontroller.clm>

## ABOUT THE AUTHOR



**Bill CHAN, M.Sc.:** Mr. Chan received a Master of Science degree from Cranfield University. In 1993, he was conferred by Shanghai Tongji University as Honorary Professor of Electrical Engineering. He worked 12 years for Clipsal manufacturing electrical switches, outlets and luminaires, and his last position was Chairman of Clipsal China Limited. Since 2007, he has been working on manufacturing and development of LED products. Now he is the President of LiteController Inc., which specializes in circadian LED lighting products and WiFi - DALI control system for tunable white applications. He owns an invention patent in LED packaging of 465–470 nm dies.

# guangzhou international lighting exhibition

# 25<sup>th</sup>

The most influential and comprehensive lighting  
and LED event in Asia

## 9 – 12 June 2020

China Import and Export Fair Complex  
Guangzhou, China

[www.light.messefrankfurt.com.cn](http://www.light.messefrankfurt.com.cn)

### Contact

Messe Frankfurt (HK) Ltd

Tel: +852 2238 9969

Fax: +852 2519 6079

[light@china.messefrankfurt.com](mailto:light@china.messefrankfurt.com)



光亞 · Guang ya



messe frankfurt

# How to Implement the Latest LED Technology for a Successful Application

The pressure for LED manufacturers to produce cheaper, more efficient and more reliable products, has dramatically increased and put pressure on their R&D teams to bring new solutions to the table from the chip to the package. But new solutions like CSP or WICOP without package are not catching on as expected because the ecosystem for production has not adapted for these latest semiconductor developments. Marc Juarez, Technical Director Europe of Seoul Semiconductor's Lighting Division explains why, discusses opportunities for speeding up transition, and gives examples based on their WICOP technology and their product portfolio.

**A**PPARENTLY the CSP technology, which is state-of-the art in display manufacturing for tablets, mobile devices or even TVs and monitors, is not really applied in general lighting manufacturing. The aim of this article is to open a discussion about why this new technology is not being adopted very quickly, even when there are clear technical advantages for the lighting manufacturers. The article will analyze the reasons in detail and shows solutions to overcome this critical situation by bringing additional value to customers.

## LED Market

The LED market is a mature market. The big investments done in epi grow reactors, packaging lines and SMT lines to mount LEDs, for example, were all done in the last 5 years and now a stabilization, a consolidation or even a small downtrend can just be seen as there is oversupply in the market. After 10 years of continuous growth, for the first time, the market decreased in 2019 without signs for a recovery in 2020.

Usually, when we talk about markets with oversupply and decrease on margins and demand, the investments are already moved or start to be moved to other sectors or technologies that can bring more profit to the companies. In extreme cases

some companies decide to step out of these "red ocean" markets: This happened at the end of 2019 when LG decided to step out of the LED business closing the LED lighting and UV divisions. It seems hardly understandable as they were one of the biggest players in LEDs just a few years ago.

The majority of the LED players have to keep investing in new technologies and new products to stay ahead of the competition. But it is a fact that investment and market is conflicting with some other factors like the evolution of the devices. One of the key points is that the LED cost is not the biggest portion anymore, and the impact of a new LED technology doesn't bring all the benefits that luminaire makers expect in order to implement such new technologies. As an example, today, in some cases, like the mid-power LEDs, the cost of mounting an LED package into a board is more expensive than the LED itself and in consequence, from a cost point of view, the number of LEDs that need to be mounted is more important than the LED itself.

## Market Resistance

LED chip and package makers try to move forward, keep new product developments and target bringing more advanced technologies and smaller devices to market, but

they find a resistance to change to more advanced and better products that requires more accuracy and new investments in the ecosystem in order to put them on a board, for example.

On one side we have the LED chip and package makers that try to make it smaller, cheaper and better and on the other side we have the resistance of the market that focuses in keeping the investments low for the traditional lighting products as the big R&D investments are now reduced or reoriented in other sides of the products. Most probably in the driver part with new IoT and smart devices to be developed or in the optic parts for example, that remains a key point for the luminaire makers.

*In the past the LED was the king and the biggest portion of the total cost but that's not the case anymore.*

MARC JUAREZ



## Going Smaller

Going smaller is the trend in electronics. For many years we have seen things becoming smaller and smaller and it's usually a good sign that the technology is developing in the right way; we use less materials, we become more efficient and the planet, companies and final users benefit from it. But it looks like the current general lighting market situation keeps investments low and changes are difficult to be implemented in the PCB and luminaire side and most of the players still prefer to keep "old" platforms in order to benefit from past investments. Even the LEDs are "bigger".

For example, most LED SMT lines used for LED general lighting are "old fashioned". But in contrast to the phone or tablet industry, most of the luminaire manufacturers and general lighting SMT assembly companies are not willing to invest in new machines to work with more precise and smaller components.

If there is not enough economic incentive to decrease the total cost and get a positive advantage in a very short term it is difficult to get investments done in a decreasing market. Most probably, if the SMT lines have already amortized, they can squeeze this small margin that is so badly needed in today's fierce cost battle at all levels in the lighting industry, from chip to finished luminaires.

*"Even though technology is moving fast in the LED industry it needs the entire ecosystem to move in parallel for new technologies to be adopted."*

MARC JUAREZ

One of the resistances we can see in the market for the adoption of the packageless LEDs is that the R&D budgets from luminaire makers have been reduced and that the actual changes in PCB design, optics, re-testing, certifications and others are not being compensated by the cost drop that the LED itself can bring to them.

Analyzing the current Epi technology for LED lighting we can do very small mini LEDs with less than 0.15x0.15 mm or even smaller like the new micro LEDs 0.05x0.05

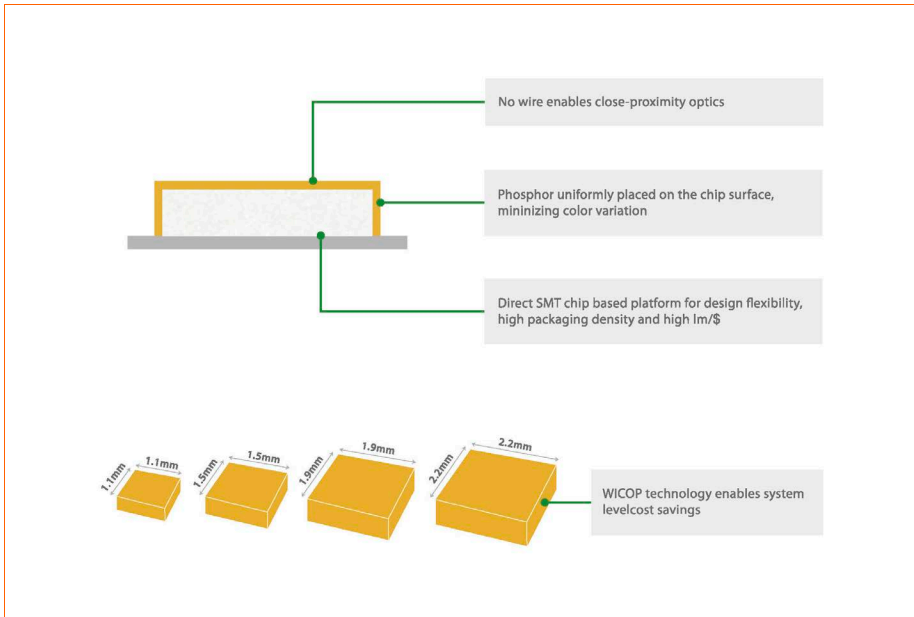


Figure 1: WICOP basic structure and size portfolio

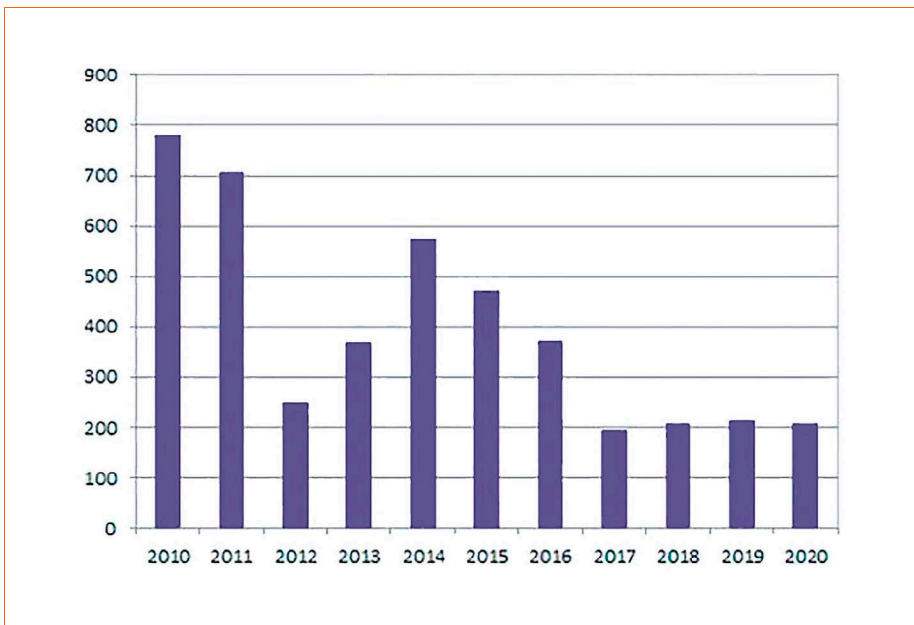


Figure 2: Annual epi-reactor sales (units) 2010-2020

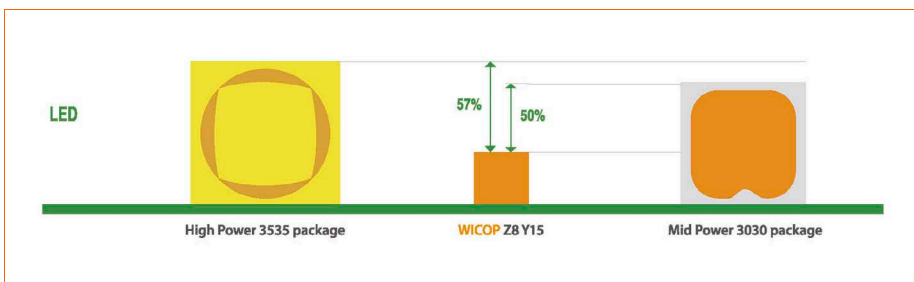


Figure 3: Size comparison of a traditional High-Power LED with WICOP and a Midpower 3030 LED

mm. But the question that rises with these new products is, which machines, pcbs, optics and ecosystems do the market need for these small components to be suitable for the current manufacturers? And of course, what is the price for these new technologies and is the market ready to pay for them?

The general lighting luminaire market is still very dominated by companies that are design houses and mechanical experts more than electronics experts. A fact that reduces their scope and vision on the edge technologies that are available.

*“Package-less technologies have been used for years in tablets and phones.”*

MARC JUAREZ

CSP and WICOP are already very good LED chips without package and this is demonstrated by good LM80 lifetime reports, good reliability, good lm/w, aggressive price and less materials used, but it seems that the gap with recent solutions in cost is not enough to drive the market to

these new technologies in general adoption.

These package-less technologies have been used for years in tablets, phones, TV’s, cars and recently, in general lighting, after the challenges of a high lifetime at high temperatures and high efficacy levels were solved.

The technology is evolving fast and we can find CSPs in all kinds of LED solutions from a mid-power LED to super-high-power array LEDs with the advantage of a very high lumen package density that also offers a new way for mixing colors and spectrums in a very small module.

### Key Success

Some of the experts in the industry see package-less LEDs as the only way to reduce cost from a ceramic package with a typical silicone dome or a plastic packaged LED. In the case of WICOP, the LEDs are completely manufactured at a wafer level that makes it much more economic and easier to produce than a packaged LED that involves many operations like die attach, bonding, curing, silicone molding, sorting, or testing.

We definitely see a bright future for LEDs

based on wafer integrated manufacturing processes as today the cost and performance are key and the integration at a module level of these components is more and more common among the CMs and lighting manufacturers.

*“One of the keys for success will be the cost that package-less LEDs could achieve in the future.”*

MARC JUAREZ

To accelerate the adoption of this new technology some LED manufacturers and packaging companies are pushing these new package-less products on the market by offering modules or more integrated solutions where the LEDs are already mounted on a board. This brings more added value to the customer and offers the knowledge and experience of manufacturers that have the technology to mount the small LEDs in-house and so they can reduce their R&D costs. The other approach to package these new chips looks weird and contradictory with what was discussed before - but yes, the customer is the King,

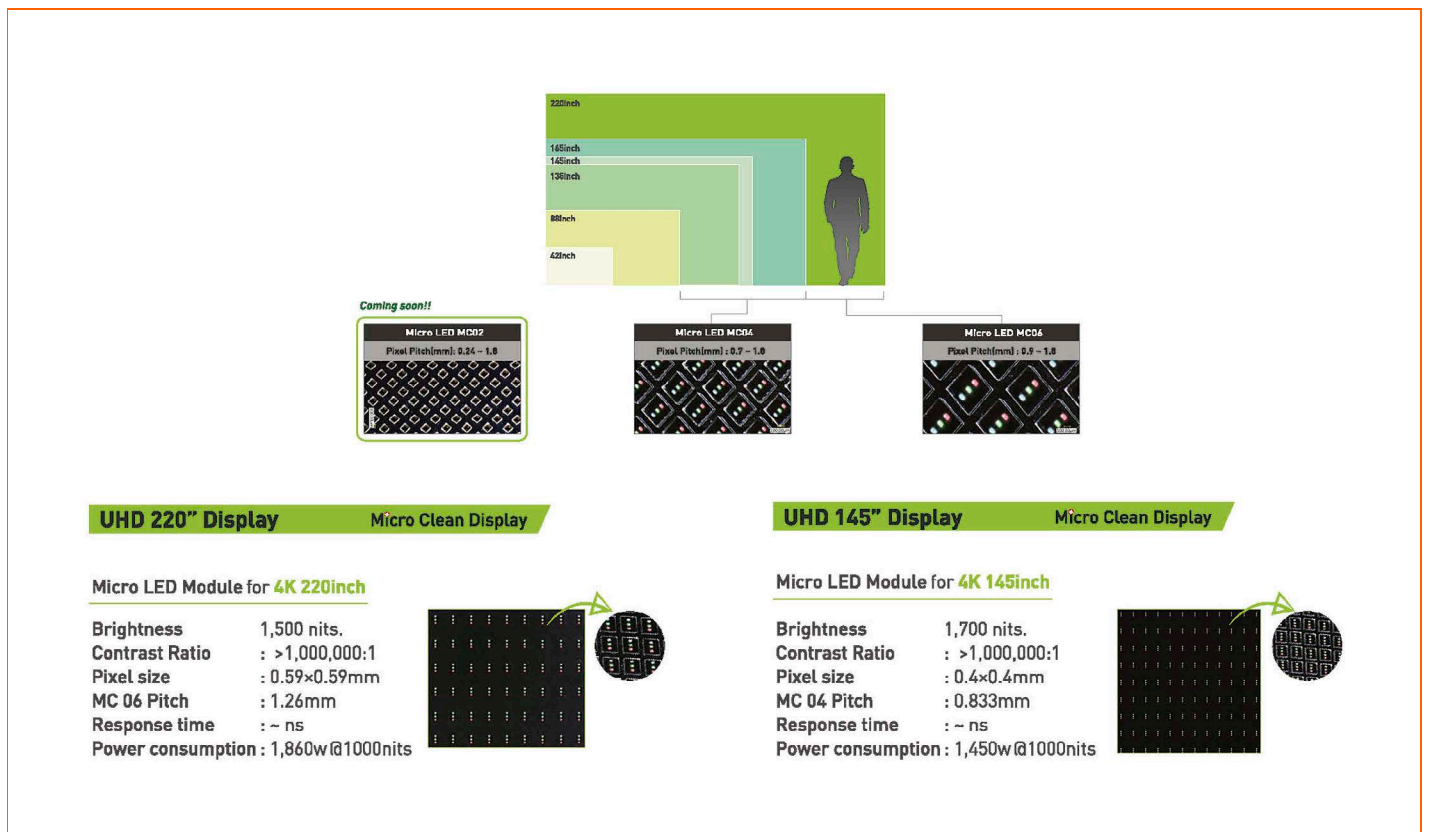


Figure 4: Micro LED technology portfolio – the question is how long will technology take that is gaining momentum in display production and will also be implemented in general lighting as CSP is still just being slowly adopted

and the results show that it is not the worst idea.

## How Manufacturers Benefit from Package-less LEDs

In order to accommodate today's customer needs and to provide the maximum benefits of this new package-less LED CSP LED chip, they are offered in many of the existing packaged LED platforms such as 3030, 3528, 5630, 3535.

For example, one of the most important packages in mid-power is the 3030 and until now companies used 1 or 2 lateral chips inside but the efficacy reached a plateau at around 200 lm/W that could not be overcome. But by using the new package-less LEDs inside a 3030 package, the result is the most efficient and robust LED on the market: It achieves 230 lm/W and still 99.5% light output after a corrosive Sulphur test.



Figure 5: 3030 Midpower package with a WICOP LED chip combines highest efficacy with extraordinary environmental stability even easily withstanding a corrosive Sulphur test

*"By using the new package-less LEDs inside a 3030 package, the result is the most efficient and robust LED on the market."*

MARC JUAREZ

In case of the high-power LEDs nearly all platforms are still based on the 3535 that has been one of the most successful and unchanged platforms for many years. Also some of the new 3535 packages have WICOP or CSP chip inside as this option offers the highest lumen/watt for a 2-Watt

high power package with great reliability (no bonding, very strong against Sulphur, high temperature/low temperature resistance).

Finally, as already mentioned, manufacturers are launching a large range of modules that include CSP technology in order for customers to easily adapt this new technology and take the benefit from small light sources, slimmer designs and great reliability at a great cost.



Figure 6: Example of a 3535 platform LED using WICOP/CSP chips

## Conclusions

It is apparent that sometimes technology grows faster than the market and it's important to understand this. This makes it all the more crucial to adapt the products to the needs of the customers. Cooperation between companies of different levels (Chip, package, SMT, PCB, optics, drivers, luminaire makers) in the same market is crucial for success.

*"It is apparent that sometimes technology grows faster than the market."*

MARC JUAREZ

For all of them, it's the only way to understand and adapt to the complex ecosystem of electronic lighting. ■

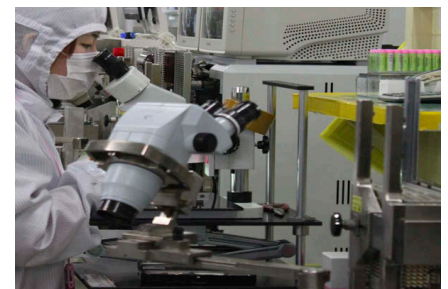
## References

- [1] Annual epi-reactor sales (units) 2010-2020. Source [www.Yole.fr](http://www.Yole.fr)
- [2] Yole study. CSP LED lighting modules: a revolution within the LED industry 2017
- [3] Seoul Viosys internal data
- [4] SSC Website <http://www.seoulsemicon.com/en>

## ABOUT THE AUTHOR



**Marc JUAREZ:** Marc is an Industrial Engineer and entrepreneur passionate about LEDs and lighting in general. He was born in lighting with the LED revolution in 2009 starting a lighting company in Spain called LEDsPRO that was successfully sold to the French company Lucibel after 2 years in the market. With the boom of the LED industry and with his company sold to Lucibel he moved to France to work in the R&D department to develop new LED luminaires and new ideas. As anecdote the French president at that time Francois Hollande was on the TV making a demo of a bulb developed by the R&D team he was working on. After 2 years in France he moved to Germany the biggest lighting market in Europe where he started a career in Seoul Semiconductor.



# Integrated Solution for Human Centric Lighting (HCL) / Integrative Lighting Assessment

Advertorial, Gigahertz-Optik GmbH

**G**igahertz-Optik GmbH, Germany (EU), is the only manufacturer of precise lighting measuring equipment that provides an integrated hardware and software solution to streamline the assessment of Human Centric Lighting (HCL) / Integrative Lighting, from design and prototyping, to commissioning in real-life spaces (offices, schools, healthcare facilities, industry, hospitality etc.). The solution can also assist with “Performance Verification (PV)” of the “WELL Building Standard” Light Concept, UL DG 24480 “Design Guideline for Promoting Circadian Entrainment with Light for Day-Active People”, and it is compliant with CIE S026/E:2018 “CIE System for Metrology of Optical Radiation for ipRGC-Influenced Responses to Light” reporting. Furthermore, it can provide precise real-time assessment of the Eh/Evmel performance metric.

As a result of the collaboration of Gigahertz-Optik with **Dr. Octavio L. Perez, Ph.D.**, WELL Accredited Professional (WELL AP), independent expert consultant in HCL, and adjunct researcher at Mount Sinai Hospital in New York City, NY, Gigahertz-Optik provides an **integrated solution for Human Centric Lighting (HCL) / Integrative Lighting assessment** where horizontal and vertical measurements can be taken simultaneously, at the same time.

Up to now, assessing Human Centric Lighting (HCL) / Integrative Lighting has been a **challenging process** for researchers, lighting fixtures manufacturers, architects, engineers, facilities managers, lighting designers and end-users. The **typical workflow** consisted in measuring light and lighting conditions with spectrometers and proprietary software, saving the different

(horizontal and vertical) spectral measurements (SPD) in excel-readable files (typically CSV, comma separated values), and then doing calculations, first in the Lucas et al. 2014 workbook, and lately in the CIE S026/E:2018 Toolbox. Reporting was next. Certainly, a cumbersome, time-consuming and error prone process. **Now, with the single push of a button** you can get all the measurements and reports for HCL / Integrative Lighting (WELL Building Standard, UL DG 24480, CIE S026/E:2018) in a **timesaving and error-free** way.

The “**WELL Building Standard**” Light Concept provides different lighting requirement specifications for the built environment, in the photopic (visual), and in the circadian (non-visual) domains. The lighting system and the environment have to be assessed for compliance with several lighting quality parameters such as light levels for visual acuity (illuminance), electric light quality (color rendering -CRI and IES-TM3018- and flicker/TLA), and circadian lighting (equivalent melanopic lux -EML- and/or CIE melanopic equivalent daylight illuminance -MEDI D65-). The software can provide **reporting and mission planning for assessment and Performance Verification (PV)** for the “WELL Building Standard” Light Concept, and it is **compliant with CIE S026/E:2018** “CIE System for Metrology of Optical Radiation for ipRGC-Influenced Responses to Light” reporting.

According to the “WELL Performance Verification Guidebook (Q1-2020)”, all these parameters must be calculated from illuminance and spectral measurements performed with **calibrated meters** (calibrated as per manufacturer specifications in an **ISO/IEC 17025 Accredited Calibration**

Laboratory and/or with NIST/USA traceable calibration).

Gigahertz-Optik is a well established and recognized German manufacturer of precise light and lighting measurement devices. All the devices are calibrated upon delivery and can be regularly calibrated per ISO/IEC 17025 Accredited Calibration Laboratories and/or NIST traceable facilities (upon request). The recommended laboratory and field spectral light meters for HCL / Integrative Lighting are the following:

- **MSC15** precise entry-level handheld stand-alone spectrophotometer with display, battery and USB for photometric and spectral measurements and calculations.
- **CSS-45** sensor for photometric and spectral measurements with USB (available with optional display CSS-D).
- **BTS256-EF** advanced handheld stand-alone spectrophotometer with display, battery and USB, for photometric, spectral, and flicker/TLA (Temporal Light Artifacts) measurement and calculations.

The operation of these three families of devices can also be automated through the use of different software solutions. Gigahertz-Optik also provides single device software and SDK DLLs (software development kits) to perform and automate lighting measurements (available in the Microsoft Windows operating system platform). ■

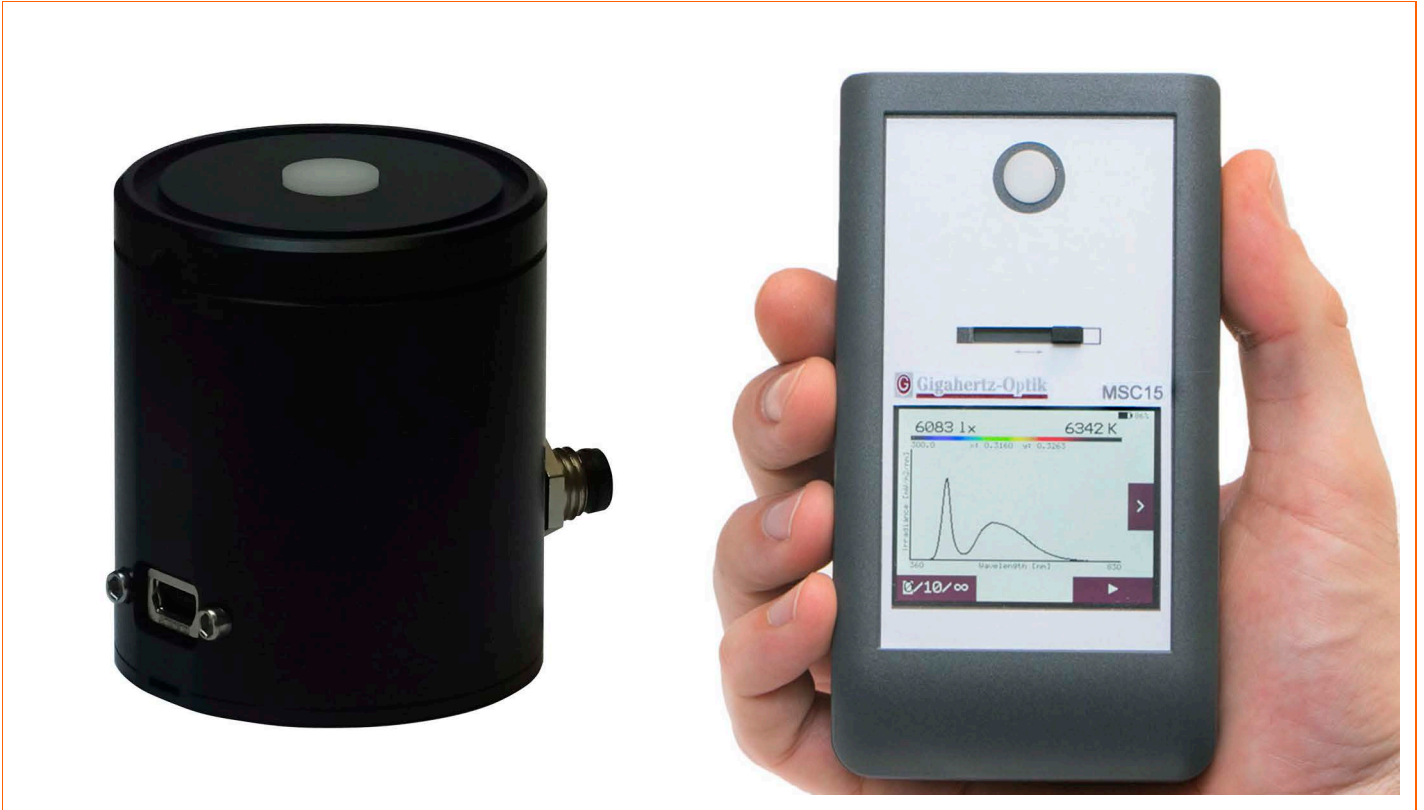


Figure 1: Gigahertz-Optik CSS-45 (left) and Gigahertz-Optik MSC15 (right)

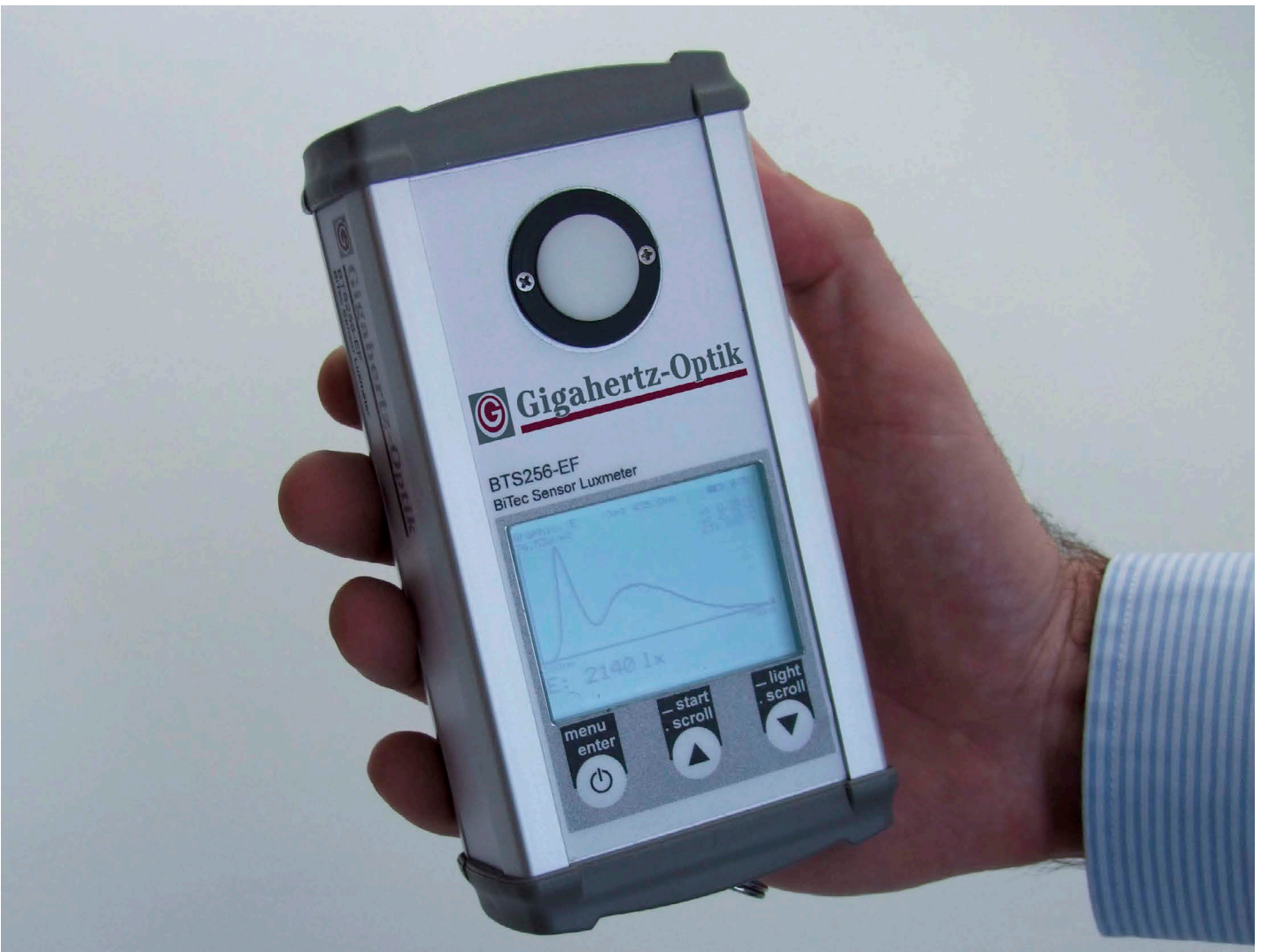


Figure 2: Gigahertz-Optik BTS256-EF

# Challenges for Measuring Multichip LED Light Engines for Interior Lighting Applications

As LED systems have been evolving in many niche applications, scientists and engineers are constantly looking for ways to reduce heat, improve performance and to get reliable data. Accurate thermal characterization of LEDs is crucial to satisfy these efforts. In their study, Mete Muslu, MSc, Onuralp Isil and Prof. Mehmet Arik from the Ozyegin University in Istanbul focused on the design and manufacturing of a thermally improved and fully operational rapid temperature controllable chamber in which calibration and test phases of junction temperature measurements are sensitively conducted under low deviation.

**W**HILE the current systems developed over the last decade reached a 40% LED light efficiency, a higher portion of the electrical input energy of LEDs is still produced as heat and it hinders their development potential. In addition, the compact size of the LED systems poses some challenges to the reliable characterization of their performance at low uncertainties. Especially the performance considerations associated with thermal loads over a limited size of LED chips require the effective characterization of these systems for various operational conditions.

One of the techniques used for this purpose is the characterization of an LED package by a decrease in forward voltage with increasing junction temperature. As LEDs are operated at higher junction temperatures, the amount and quality of the light deteriorates significantly, and the less efficient use of the LEDs results in additional operating costs and reduced lifetime of LEDs. In fact, accurate identification of thermal behavior of LED packages is one of the essential tasks towards improving the design of LED systems. If thermal characterization of LEDs is accurately done, performance parameters of LED packages are more reliably optimized to yield the highest possible performance ratios. Thus, this study focused on the design and manufacturing of a thermally improved and fully operational rapid temperature controllable cham-

ber in which calibration and test phases of junction temperature measurements are sensitively conducted under a low uncertainty.

## Introduction

Considering the significant amount of heat loss in current single LED chips (approximately 60 to 70% of electrical input power [1]), thermal issues are still significant and better cooling techniques or low power consumption technologies are required since the optical performance of LEDs is directly affected by thermal conditions [2], [3], [4]. Individual LEDs in multi-chip systems are even more affected by the existence of electrical components in the circuits and thermal loads induced by other LED chips. In fact, it has been shown that thermal losses caused by electrical components in a circuit could reach almost the same levels as radiant energy [5]. In the study, it was also shown that conversion efficiency of a multi-chip LED module drops by 6.1% due to the existence of electrical components. In future applications where Internet of Things (IoT) sensors are more included in lighting products, the severity of thermal problems in lighting units is expected to be more sound as the sensors are placed with additional electrical components. As more and more electronic devices are connected to each other via IoT sensors, human-to-human, human-to-device and device-to-device communication will find a great place in many improved everyday prod-

ucts. Considering the existence of lighting products in many interior, exterior and industrial uses, an LED system will inevitably include various IoT sensors as a future lighting and communication device. On the other hand, some performance parameters of LEDs such as lifetime, efficiency, color and amount of light generation are greatly affected by thermal conditions [6], [7], [8] and the adaptation of IoT sensors to the LED systems may require significant understanding of thermal behavior of LEDs in multi-LED systems. Thus, accurate measurement systems are needed to determine junction temperature of LEDs and improve the performance of high-power LEDs based on thermal data provided at their normal operation. If accurate temperature measurements are performed in this area, then it will be very practical for many industry experts, researchers and engineers to thermally characterize the design of LED systems including IoT sensors and associated electrical components. This will enable them to realize performance optimization of their LED products.

In addition, current junction temperature measurement systems are operated using transient measurement methods that require the derivation of a thermal resistance versus thermal capacitance relationship to determine structure function and junction temperature of LEDs over a one-dimensional heat flow path [9], [10], [11]. However, the method with one dimensional heat flux assumption is questioned especially for junction temperature mea-

measurements of white LED packages that include phosphor coating over the LED chip. This is mainly attributed to the impact of three-dimensional heat flow on the rise of junction temperature [12]. In junction temperature measurements of multi-chip LED systems, one dimensional heat flux assumption raises even more concerns due to the increased thermal interaction between LEDs and electrical components in the lighting unit, generated local hot spots over the electrical board and three-dimensional heat flow in those systems. Considering alternative cooling systems developed for future lighting systems and the inclusion of IoT sensors in these units, accurate measurement of junction temperature of LED chips will be critical to ensure that the lighting unit is designed to operate in its optimum condition.

In addition to the raised concerns about heat flux assumption in measurements, the current measurement systems are not applicable to measure junction temperature of serially connected LEDs in multi-LED systems. Thus, this study primarily focuses on developing a junction temperature measurement system for single and multi-LED system and investigates the challenges behind the accurate measurements of these systems.

## Methodology

### Junction temperature measurement technique

Junction temperature measurements are conducted based on the improved version of forward voltage change technique introduced by A.M. Muslu, and M.Arik, 2019, "Impact of Electronics over Localized Hot Spots in Multi-Chip White LED Light Engines" [5]. Measurements are initiated with the calibration of each LED located on the PCB. In calibration, the relationship between junction temperature and forward voltage is set with the use of a temperature controllable oven system.

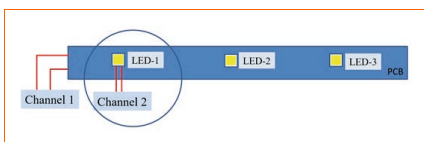


Figure 1: Evolutionary steps in Rapid Production (Electrical connections of two channels of a source-meter device for junction temperature measurements of LEDs [5])

The oven system provides steady state and thermal equilibrium conditions in which

junction temperature of an LED chip can be regarded as the oven temperature. In the second phase of the measurements, an LED unit is operated with its normal operation current or voltage until it reaches steady state condition. Then, the junction temperatures of individual LEDs are determined with the multi-channel sourcemeter system. The technique requires the separate application of electrical input power to the LED board and an individual LED whose junction temperature is to be determined. Applying energy to the LED board from the first channel enables each LED to reach their junction temperatures at steady state during their normal operation.

Once this is achieved, the first channel is turned off for 1 millisecond (ms) pulse duration and the second channel is simultaneously turned on and the pulse current of 1 milliampere (mA) is applied on the individual LED whose junction temperature is to be measured. The forward voltage drop on the LED is also measured by the second channel after applying 1 mA pulse current. The procedure is repeated ten times and the forward voltage readings are evaluated to ensure the range of results is within 0.1 mV. This ensures that junction temperature measurements were conducted at steady state operation of the LED board since 0.1 mV change in forward voltage readings of the pulse current application corresponds to the change in the results of repeated junction temperature measurements by around 0.07 °C as shown in the results section of the study. Before conducting measurements, the electrical wires were soldered to the LED leadframes in order to apply pulse current to the individual LED chips and measure the forward voltage from the second channel of the sourcemeter system. The LED board after additional wires are soldered and the test phase of the introduced technique are seen in **Figure 1**.

In order to conduct junction temperature measurements of LEDs described above, a sourcemeter integrated test chamber (oven system) was developed to provide steady state and thermal equilibrium conditions in the calibration phase, apply electrical power to the LED system and measure junction temperature at normal operation of the LED product.

### Computational analysis and test chamber (oven system) design

This study requires a robust and reliable thermal chamber with precise temperature conditions in order to determine the cali-

bration data (junction temperature versus forward voltage) for an LED chip. Thermal steady state must be achieved for each measurement point.

Parameter	Specification
Temperature Range	+25°C - 100°C
Chamber Dimensions	110mm x 110mm x 110mm
Temperature Gradient	+/- 0.5°C
Heating and Cooling Rate	1.5 °C/min
LED Chip Connector Amount	6 Chips
Cooling Liquid	Water

Table 1: Operating conditions for measurement device

Thermal equilibrium is considered as a temperature change of no more than 0.1 °C or a minimum of 10 minutes, in every temperature reading of the system. These values are picked from the previous studies performed by Tamdoğan et. al. [13]. The objective was to design a heating and cooling chamber with a high temperature change speed and uniformly distributed temperatures. Operating conditions are determined as shown in **Table 1**. According to the



Figure 2: Measurement chamber

operating conditions, an aluminum oven design is considered for a chamber enclosure. The proposed design consists of aluminum walls with embedded cylindrical heaters and liquid cooling path to ensure a rapid heating and cooling cycle to reach a certain temperature set. That said, 15 mm thick aluminum plates with drilled holes for circulation of the coolant is designed for a compact design. The model is manufactured by conventional manufacturing methods and does not require numerous

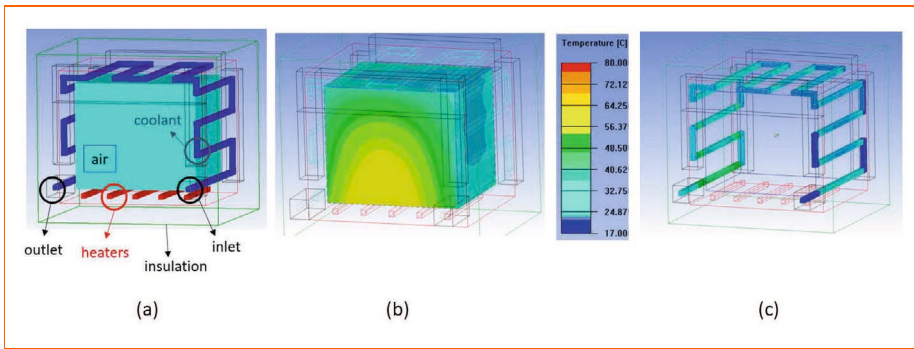


Figure 3: ANSYS Icepak model of the oven system(a), the change in temperature distribution of air inside the oven system during transient simulations (b), the change in temperature distribution of cooling liquid inside the drilled holes in the oven walls (c)

pipng and clamping systems that increase the number of defect points.

A collector is designed for connecting inner channels of the coolant in order to have one inlet and one outlet for the whole measurement chamber. These collectors are used for transferring the fluid from one channel to another while maintaining the sealed foundation with sealing rings conforming to temperatures of more than 200 °C. **Figure 2** shows the assembled measurement chamber structure.

Transient thermal analysis was made to determine design parameters that result in a desired heating and cooling rate of the test chamber. Thus, the oven model was created in ANSYS Icepak [14] (see **Figure 3**) including heating and cooling subsystems. The change of air and water temperature in the system was monitored in simulations. It was aimed to achieve over 1.5 °C/min heating and cooling rate of the air.

After the analysis, it was decided that 6 mm diameter drilling holes that the coolant water passes through, three 225 W capacity heaters, 17 °C inlet water, 11 × 11 × 11 cm<sup>3</sup> internal volume chamber and 15 mm thickness insulation layer satisfy the heating and cooling rates over 1.5 °C/min. The details of the selection process and other units of the system are described below.

Circulation pump for cooling fluid (water) is selected depending on the rate of the mass needed for optimum heat transfer from aluminum walls to the water. 4 L/min water at 25 °C is needed as flow rate from the circulation pump. Local pressure losses decrease the flow rate of circulation pumps, which is why pressure required at the inlet is calculated with the number of bends in connectors and plates. 1.3 bar of pressure is required for the water to be pushed to the other side. Then, according to the operating pressure-flow rate, the nominal flow rate of the circulation pump was determined.

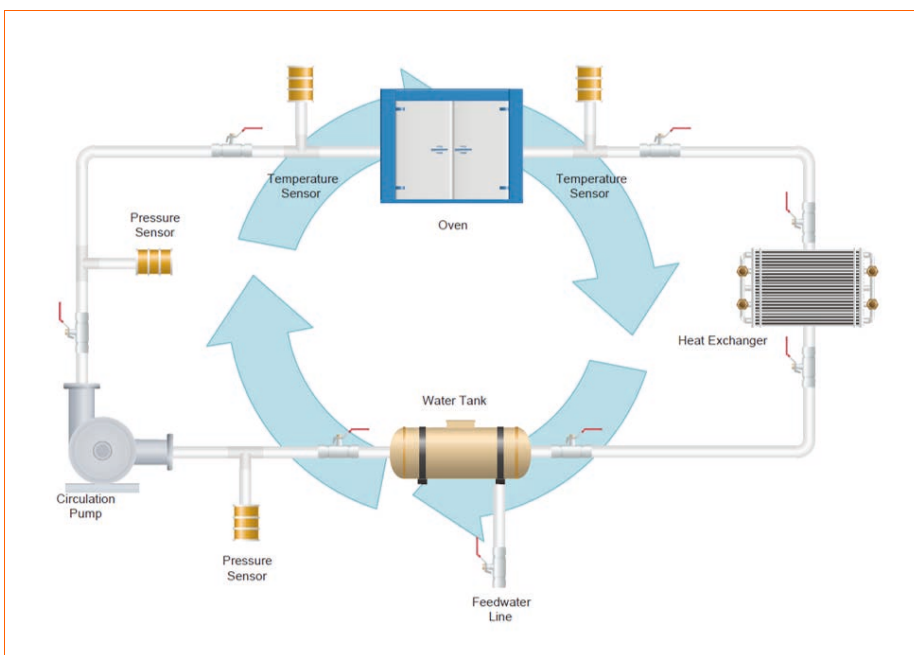


Figure 4: Schematic of the measurement device

A circulation pump with a nominal flow rate of 18 L/min and working pressure of 4.2 bar is selected. Cooling is done with the help of a fan driven plate type heat exchanger, of which the plate distance and dimensions are determined from the required cooling capacity of the chamber to operate with a rate of 1.5 °C/min (see **Figure 4** for the cooling subsystem of the measurement device). Since the temperature of the measurement device will be reaching 100 °C, stone wool is used for insulation instead of polyurethane panels that have been observed to melt at temperatures of more than 80 °C. On top of the insulation, a 1 mm thickness of powder painted sheet metal bent structure is installed.

### Manufacturing of the oven system

After determining measurement methodology and conducting computational analysis to achieve a preferred heating and cooling subsystem of the measurement device, the oven system was manufactured to enable a temperature controllable environment with heating and cooling control on the oven walls.

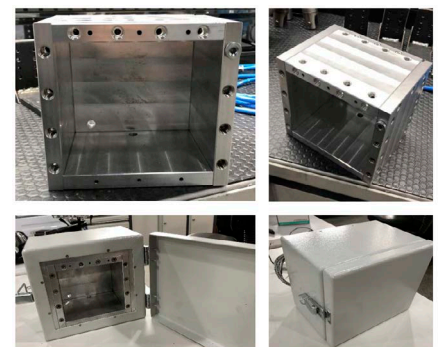


Figure 5: The manufactured oven system

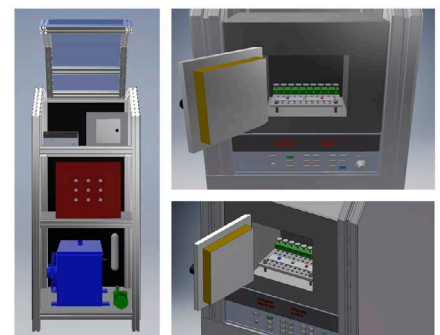


Figure 6: The assembly of all test units

The manufactured oven system is seen in **Figure 5** without inlet and outlet connections and the LED mount attachment. In **Figure 6**, the assembly of all test units in a compact measurement system is observed. It includes a heat exchanger, cir-

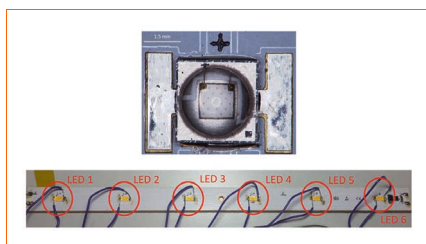


ulation pump, reservoir, sourceme- ter and oven system as main components.

The oven system as in **Figure 5** has drilled through holes on their walls and coolant liquid is circulated in these holes from the inlet to the outlet position. The circulation of cold liquid reduces the temperature of the oven walls and ultimately drops the ambient temperature. On the other hand, the heating of the oven walls and air in the test chamber is provided with the cylindrical rod heaters tightly embedded in the bottom wall of the oven to adjust a certain air temperature. The heating of the ambient air is facilitated by the movement of heated air particles to the upper positions of the test chamber as a result of natural convection currents. Temperature sensors (J type sensors) are also embedded in the heating and cooling walls to keep track of thermal conditions of the oven system and provide uniformly distributed temperature profiles at a steady state condition during the junction temperature tests. As an attachment to the test chamber, an LED mounting table is created with multiple electrical connectors and extension cables properly taken out from the back wall of the oven system. The oven system is also insulated with an insulation material (stone wool) durable at the operating temperature range of the system (maximum 100 °C).

## Results and Discussions

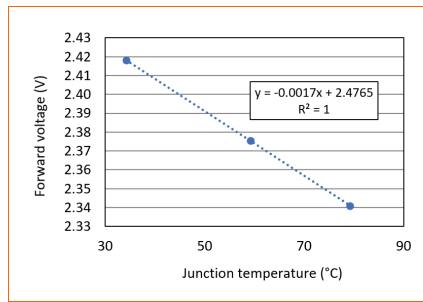
In this study, junction temperature measurements of a single blue LED and white multi-chip LED system (see **Figure 7**) were realized with the proposed measurement technique in a novel measurement device.



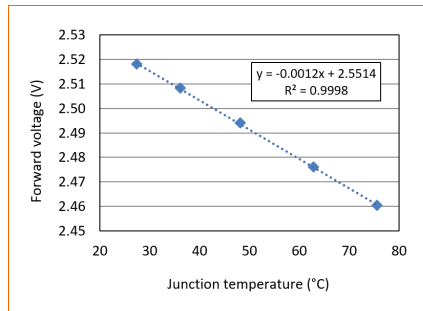
**Figure 7:** A single blue LED chip and a white multi-chip LED system for junction temperature measurements

The calibration of LEDs was conducted with 1 milliampere (1 mA) pulse current for 1 millisecond (1 ms) pulse duration to prevent additional heating over the LED chip at a certain stabilized oven temperature. Junction temperature of LEDs was assumed to be equal to the oven temperature once steady state and thermal equilibrium conditions were satisfied in the oven.

Then, calibration phase of measurements



**Figure 8:** Relationship between junction temperature and forward voltage for a single blueLED chip



**Figure 9:** Relationship between junction temperature and forward voltage for the LED-1 in a white multi-chip LED system

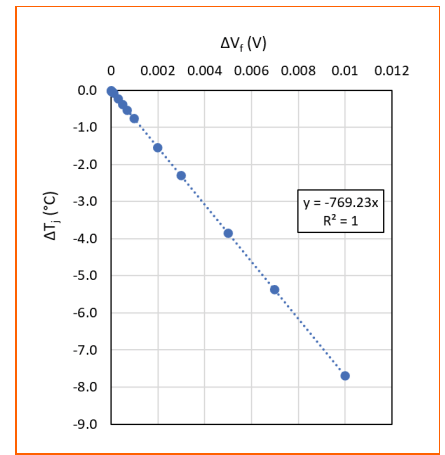
was conducted as described in the Methodology section. The relationship between junction temperature versus forward voltage was created individually for multi-chip the LED system from the soldered wires using the pulse current application channel of the sourceme- ter system. The relationship between two parameters are demonstrated in **Figure 8** and **Figure 9** respectively.

### Sensitivity Analysis

Calibration and test phase of junction temperature tests were conducted with repeated forward voltage measurements to increase the reliability of the results.

To ensure that the measurements were conducted after the steady state condition was reached, the variation between forward voltage measurements and its effect on junction temperature results were examined. According to the analysis, a variation criterion was determined between repeating forward voltage measurements to minimize measurement uncertainty of junction temperature results based on the allowed resolution of the measurement equipment. The variation between repeated forward voltage results and the corresponding junction temperature measurement sensitivity with this variation are shown in **Table 2**.

The analysis was made based on a calibra-



**Figure 10:** Junction temperature sensitivity of a single blue LED with the variation in repeated forward voltage readings

tion equation of a single LED derived with 1 mA pulse current application for 1 ms pulse duration ( $V_f = -0.0013 * T_j + 2.5939$ ). Based on this analysis, measurement uncertainty of junction temperature tests was limited to 0.1 °C in test phase and the LED was operated at its driving current until steady state is reached and maximum variation of 0.1 mV between ten repeated measurements is achieved. The overall analysis and the relationship between variation in repeated forward voltage readings and junction temperature sensitivity is given in **Figure 10** and **Table 2**.

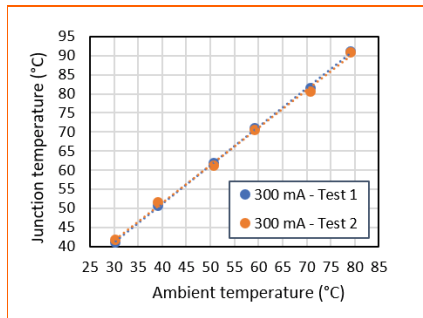
$\Delta V_f (V)$	$\Delta T_j (^\circ C)$
0.00001	-0.0077
0.00003	-0.0231
0.00005	-0.0385
0.00007	-0.0538
0.0001	-0.0770
0.0003	-0.2308
0.0005	-0.3846
0.0007	-0.5385
0.001	-0.7692
0.002	-1.5385
0.003	-2.3077
0.005	-3.8462
0.007	-5.3846
0.01	-7.6923

**Table 2:**  $\Delta V_f$  versus  $\Delta T_j$

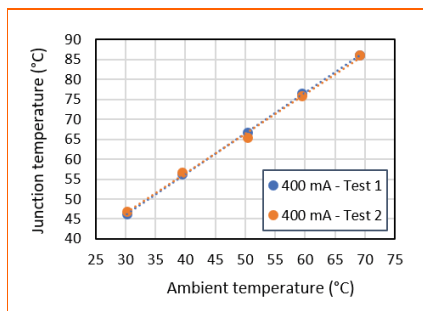
### Junction temperature measurements

Test phase of the junction temperature measurements were carried out in various ambient conditions and the LED system was operated at a steady state condition defined as the change in board temperature by 0.1 °C in 15 minutes.

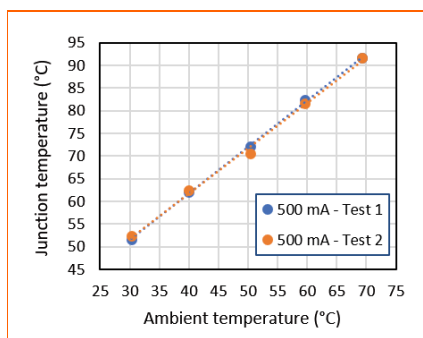
Junction temperature measurements of a single blue LED were conducted two times at different ambient conditions from 30 °C to 80 °C with 10 °C increments and at various driving currents (300, 400 and 500 mA) to observe the repeatability of tests. The results have shown a good agreement with a maximum variation of 1.6 °C between two series of measurements (see **Figure 11**, **Figure 12** and **Figure 13**).



**Figure 11:** Evaluation of repeatability tests with a single blue LED driven at a 300mA operating current at different ambient temperatures

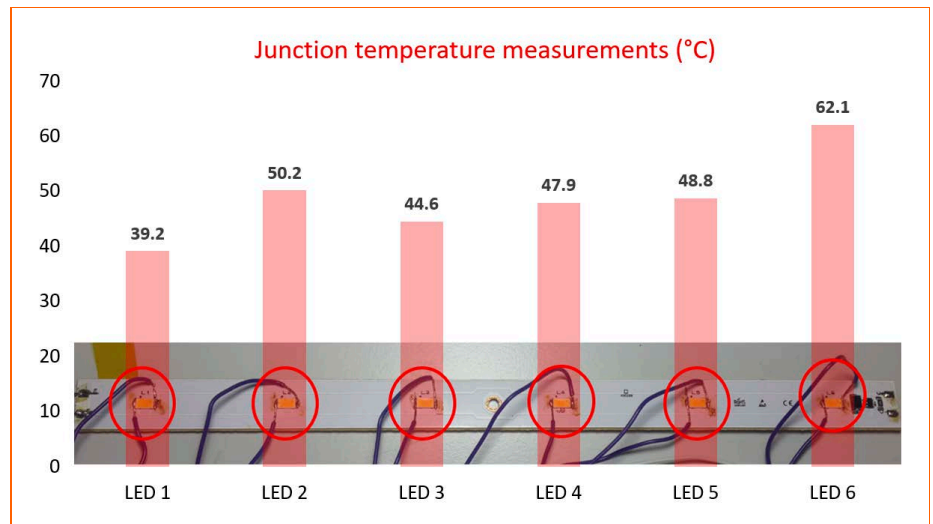


**Figure 12:** Evaluation of repeatability tests with a single blue LED driven at a 400mA operating current at different ambient temperatures



**Figure 13:** Evaluation of repeatability tests with a single blue LED driven at a 500mA operating current at different ambient temperatures

A multi-chip LED system was also operated with the application of 24 V at 23 °C ambient temperature and thermal behavior of individual LEDs was determined with junction temperature measurements to characterize the thermal condition of the LED system as seen in **Figure 14**. It was noticed that the



**Figure 14:** Junction temperature distribution of LEDs in a white multi-chip LED system

LED 6 has the highest temperature since it is located in a very close position to electrical components in the lighting unit. As the distance from the electrical units increases, junction temperatures of LEDs are observed to be gradually decreasing; however, the junction temperature of LED 2 is measured to be the second highest. This is also supported by solder point measurements with a T-type thermocouple and may be attributed to the inappropriate packaging of the LED 2 on the circuit board since this could contribute to the increase in total thermal resistance of the LED package.

## Conclusions

In this study, junction temperature of a single blue LED and multi-chip white LED was measured with a proposed junction temperature measurement device. The measurement method applied with the introduced device does not include the transient measurement technique with one dimensional heat flow assumption. Instead, steady state junction temperature measurements are carried out with a pulse current application and two-channel simultaneous operation and measurement technique. The measurement system could play a significant role in reliable measurements of junction temperature that directly affects the optical performance and lifetime of LEDs and offer a practical solution to the determination of junction temperature of individual LEDs in multi-chip systems. These measurements are believed to be even more significant in future applications when Internet of Things (IoT) sensors and associated electrical components are more frequently included in LED lightings units. Thus, the measurement system can characterize the thermal condition of an LED unit and allow researchers, engineers and experts to optimize the design of their LED

products considering various heat generators in their modules. ■

## References

- [1] X. Luo, R. Hu, S. Liu, and K. Wang, "Heat and fluid flow in high-power LED packaging and applications," *Prog. Energy Combust. Sci.*, vol. 56, pp. 1–32, 2016.
- [2] Weng, C., 2009, "Advanced thermal management and management of LED packages", ELSEVIER, *International Communications in Heat and Mass Transfer*, Volume 36, Issue 3, Pages 245–248.
- [3] Wu, H., Lin, K., Lin, S., 2012, "A study on the heat dissipation of high power multi-chip COB LEDs", ELSEVIER, *Microelectronics Journal*, Volume 43, Issue 4, Pages 280–287.
- [4] Yuan, L., Liu, S., Chen, M., Luo, X., 2006, "Thermal Analysis of High Power LED Array Packaging with Microchannel Cooler", IEEE, *International Conference on Electronics Packaging Technology*.
- [5] A. M. Muslu, and M. Arik, 2019, "Impact of Electronics over Localized Hot Spots in Multi-Chip White LED Light Engines", IEEE, *ITHERM Conference*, 2019, Las Vegas, USA.
- [6] M. Ha, S., Graham, 2012, "Development of a thermal resistance model for chip-on-board packaging of high power LED arrays", ELSEVIER *Microelectronics Reliability*, Volume: 52, Issue: 5, Page: 836.
- [7] M. Arik, C. A. Becker, S. E. Weaver, and J. Petroski, "Thermal management of LEDs: package to system," no. January 2004, p. 64, 2004.
- [8] A. Muslu, B. Ozluk, E. Tamdogan, and M. Arik, 2017, "Impact of junction temperature over forward voltage drop for red, blue and green high power light emitting diode chips," *Thermal and Thermomechanical Phenomena in Electronic Systems (ITHERM)*, 16th IEEE Intersociety Conference, Orlando, FL, USA.
- [9] Y. Luo, "Use Isothermal Surface to Help



# REPRO-LIGHT

Understanding the Spatial Representation of Structure Function,” pp. 63–68, 2012.

- [10] E. Juntunen, O. Tapaninen, A. Sitomaniemi, and V. Heikkinen, “Effect of Phosphor Encapsulant on the Thermal Resistance of a High-Power COB LED Module,” vol. 3, no. 7, pp. 1148–1154, 2013.
- [11] L. Yang, B. Wei, and J. Zhang, 2012, “Transient thermal characterization of organic light-emitting diodes”, Semiconductor Science and Technology, 27(10), 105011.
- [12] A. Hanß, M. Schmid, E. Liu, and G. Elger, “Transient thermal analysis as measurement method for IC package structural integrity Transient thermal analysis as measurement method for IC package structural integrity,” 2015.
- [13] E. Tamdogan, G. Pavlidis, S. Graham, and M. Arik, “A Comparative Study on the Junction Temperature Measurements of LEDs With Raman Spectroscopy, Forward Voltage Methods,” IEEE Trans. Components, Packag. Manuf. Technol., vol. 8, no. 11, pp. 1914–1922, 2018.
- [14] ANSYS Icepak, 2013, ANSYS Icepak Tutorials, Release 15.0, ANSYS, Inc.

## ABOUT THE AUTHOR



**Mete Muslu, MSc:** Mr. Muslu received the B.Sc. degree in mechanical engineering from Ozyegin University, Istanbul. He is currently pursuing his M.Sc. Degree in mechanical engineering in Ozyegin University. Mr. Muslu was a member of a competition team who received the “Best Commercial Potential Award” in developing a novel thermal connector design sponsored by U.S. Defense Advanced Research Projects Agency (DARPA) in 2015. From 2014 to present, he is a research assistant in EVATEG (Energy Efficient Lighting Technologies Research, Development, Education and Demonstration Center). His research interests include optoelectronics and thermal management of electronics.

## Initiating Transformation in the European Lighting Industry

Repro-light is a European research project that aims to support the European lighting industry in moving towards a more sustainable and competitive future.

[www.repro-light.eu](http://www.repro-light.eu)



# How to Increase the Efficiency of Two-Stage Drivers

In this article, Dr. Weirich from Infineon Technologies, describes a simple method for increasing the efficiency of drivers that can operate with LED engines with a wide range of current and power levels, at virtually no effort. In addition, the method allows for using smaller inductors in the buck stage, leading to lower cost and potentially, smaller size.

**L**ED drivers based on two-stage topologies are much favored thanks to their excellent performance when it comes to input power quality, wide dimming range, and a high quality of light. For power output levels of up to about 50 W, it is extremely popular to combine a PFC flyback and a constant current output buck as a second stage. Such an approach allows for optimization of virtually all aspects of the application since the combination increases design freedom compared to a single-stage driver. However, achieving very high efficiency can be challenging for two-stage topologies. The presented method gives a higher efficiency at no added cost nor design complexity. Moreover, it allows the usage of a smaller inductor value and size in the buck, leading to more compact designs.

## LED Drivers and the Quality of Light

Quality of light, first and above all, means the absence of any lighting artefacts, e.g. flicker and stroboscopic effects. Both are caused by modulation of the LED current and should be as small as possible. That means that the design goal for good light quality is an output current that is as close as possible to pure DC under all operating conditions. Any modulation generated by an AC component of the driver output will be detectable in the light output with a negative impact on the quality of light. Currently, there is no mandatory standard for such lighting artefacts, but the maximum light modulation levels given in IEE1789-2015 are a reasonable guide [1].

A second important aspect comes up when the driver is dimmable. In that case, the lowest dimming level is an important

performance indicator and the conformity of this level between different drivers is central. In other words, the lowest dimming level must be highly accurate. What is extremely important is the absence of any light artefacts caused by this low output power condition. Low dimming levels are often implemented by discontinuous LED currents either by using PWM modulation or by going in discontinuous mode of the output stage. Both will cause some modulation of the light and might reduce the light quality.

Now let's consider the requirements for the input side of the driver. International standards, such as IEC 61000-3-2:2014 [5] demand a high power factor (PF) and low harmonic content (THD) of the input current. Essentially, this means that the input current is exactly in phase with the input voltage and that it has a precisely matching waveform, i.e. no distortions. IEC 61000-3-2:2018, the 2018 edition of the above-mentioned standard [6], is applicable for input power ratings above 5 W and addresses dimmable drivers in more detail than before. Briefly, the requirements for input power quality seem to be extremely difficult to meet with a converter that needs to manage proper LED driving as well.

Consequently, single-stage drivers are dropping in popularity and are increasingly replaced by two-stage solutions. They make it much easier to optimize the first stage for an excellent power quality over a wide range of output powers. The second stage is then fed with a reasonably stable DC voltage and can be optimized to provide a clean and stable supply current for the LEDs.

As depicted in **Figure 1**, there are two basic configurations for two-stage drivers: galvanic isolation after the first or after the

second stage. It is obvious that the second configuration is not well suited for applications that demand more than one output channel, for example, tunable white or RGB solutions. It may also be a disadvantage in some single output channel applications where, in the second solution, the dimming interface is not isolated from power line. All this is completely independent of whether a primary side regulation (PSR) or a secondary side regulation (SSR) is used. We can conclude that two-stage LED drivers based on an isolated PFC followed by a buck stage are the most versatile solutions for power levels up to about 50 W and maybe even somewhat higher. That explains why the topology has become extremely popular for high light and power quality LED drivers.

## System Efficiency

The described two-stage solution presents challenges for designers as well. Achieving very high efficiency is one of them. This can be illustrated by a simple example. If the first stage achieves an efficiency of 92%, which is an excellent value for a flyback, and the buck has 97%, the system efficiency will be slightly above 89%. Considering the upcoming EU directive for lighting, the Single Lighting Regulation (SLR), which will replace several previous regulations and will demand an efficiency of at least 85% for a 50 W driver, there seems to be a comfortable margin. Many driver manufacturers nevertheless consider higher efficiencies as important, especially since that would result in lower cooling effort in an often thermally critical environment. Consequently, they have their own standards such as minimum efficiency of 88%, a number heard often. It needs to be emphasized that this efficiency level is desired over a wide load range, not only at maximum load.

There are a bunch of known measures to increase efficiencies of both stages. But all these measures considerably increase the complexity and cost of the driver. In case of a hysteretic buck, such as Infineon's ILD6150 or ILD8150, combined with an SSR flyback like XDPL8218, there is a simple solution to increase efficiency. This solution consists simply of a changed arrangement of the feedback circuit. With this new arrangement, the output voltage of the flyback becomes variable while the difference between flyback and LED output voltage is regulated.

### Hysteretic Buck Efficiency Increase

One thing worth mentioning is that the hysteretic buck is an almost perfect solution for the second stage of a LED driver. Deeper insights on hysteretic buck operation are provided in the application note on ILD8150 80V high side buck LED driver IC with hybrid dimming [2]. Further details of the theory of operation of hysteretic bucks are readily available for an interested reader in [2].

Its operation principle is perfectly suited to provide constant output current since there is no feedback loop needed to stabilize this current. No feedback loop implies that no loop-compensation is needed either. Consequently, the hysteretic buck is unconditionally stable under all normal input and output conditions. Finally, as the schematic in **Figure 2** clearly shows, component count is small, especially if the MOSFET is integrated.

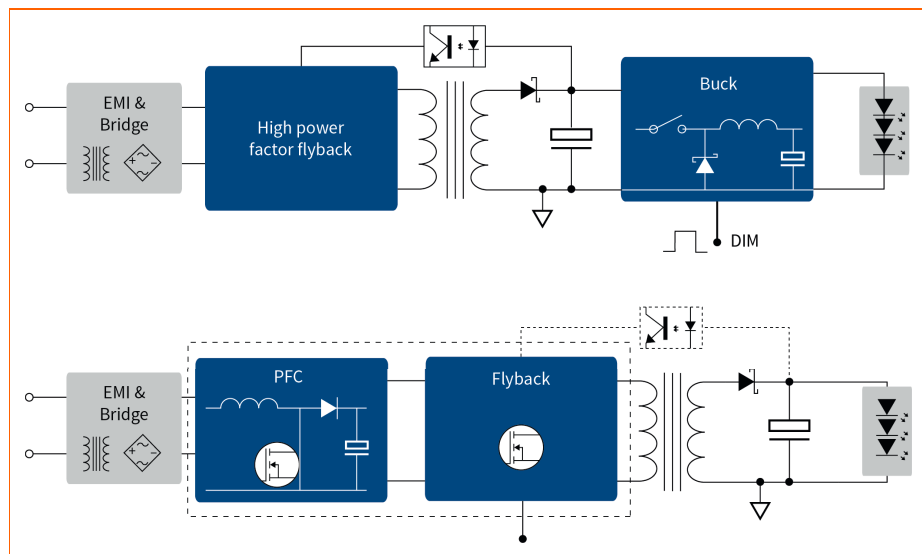


Figure 1: Two basic configurations for two-stage LED drivers

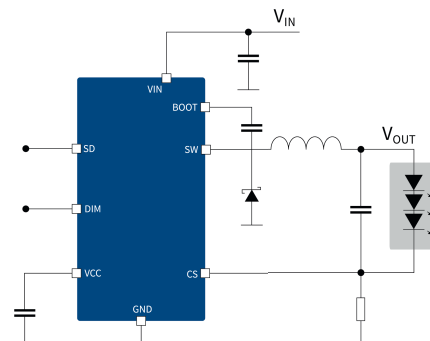


Figure 2: Schematic of hysteretic buck with ILD8150

Key to understanding the idea behind the proposed efficiency improvement is the fact that the hysteretic buck is operating with variable switching frequency  $f_s$ . This switching frequency is determined by the value of the inductor  $L$ , the amplitude of current ripple  $\Delta i$ , and, finally, input and output voltages  $V_{IN}$  and  $V_{OUT}$ .

Why is the switching frequency  $f_s$  so important? Simply because it dominates the losses in a hysteretic buck and, in turn, the efficiency. As can be taken from [2] and [3], total conduction loss (i.e. the sum of conduction loss of MOSFET and diode) is governed by their respective resistances and by the LED current. On the other hand, switching loss is heavily dependent on  $V_{IN}$  as well as  $f_s$ .

Analysis in [2] reveals that the difference  $V_{IN} - V_{OUT}$  between input and output is the dominant term in the expression for  $f_s$  and that the variation of the latter is much lower, if the difference  $V_{IN} - V_{OUT}$  is kept constant, as illustrated in **Figure 3**.

With a fixed  $V_{IN}$  (blue curve), the frequency rises rapidly with a falling LED voltage and almost triples when the output voltage drops by one third. Consequently, not only will the switching losses of the buck rise by a factor of almost three, but also the losses in the inductor will increase by a similar factor. What the fixed  $V_{IN}$  curve (blue curve) shows is that the selection of a suitable inductor is not an easy task. The value of the inductor needs to be small enough to keep the switching frequency above audible range under all

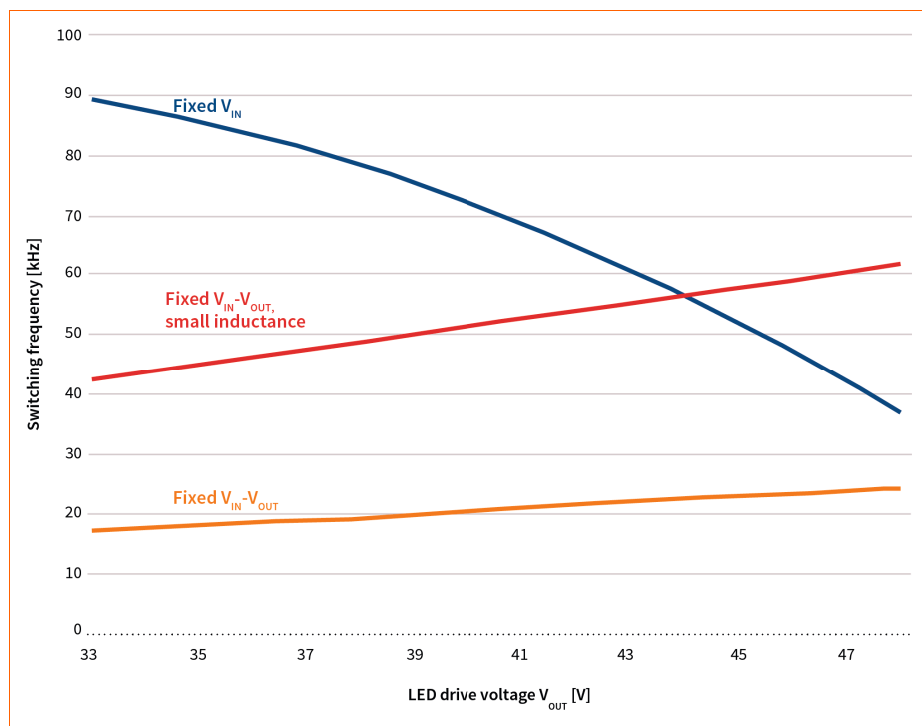


Figure 3: Variation of switching frequency vs.  $V_{OUT}$  of a hysteretic buck with fixed  $V_{IN}$  (blue), fixed  $V_{IN} - V_{OUT}$  (yellow), and fixed  $V_{IN} - V_{OUT}$  plus 2.5 times lower inductance (red)

conditions but must not allow  $f_S$  to go too high in order to limit the losses. Switching frequencies higher than 150 kHz may cause issues with conducted EMI as well.

When the difference  $V_{IN} - V_{OUT}$  is kept constant (yellow curve), the behavior changes completely. The frequency is linearly going down with the LED voltage. That implies that the inductance can be reduced considerably, say halved, while still having lower switching frequency in the majority of the operating range. In case the size of the inductor is kept the same, a lower inductance means lower turns and less losses. But it may be even more appealing to a designer to use a smaller inductor size and value. The red curve in **Figure 3** has been calculated with an inductor value that is 2.5 times lower (340  $\mu$ H) than what is the case for the other two curves (860  $\mu$ H). That still leads to pretty moderate frequencies, all below 85 kHz in this case, which are extremely unlikely to cause any EMI issues. We can expect that the efficiency improves greatly in most parts of the load range and that there is a prospect for reduction of inductor size, leading to a more compact design and lower cost.

## Implementation

The developed concept is surprisingly simple to implement. Instead of stabilizing the output voltage of the flyback stage, as shown in **Figure 4a**, the difference of the input and output voltages of the buck is regulated to a constant value of e.g. 5 V (**Figure 4b**). This regulation mainly needs a restructuring of the feedback network so that almost no additional components are needed, except for some low-cost resistors. Extensive theoretical analysis

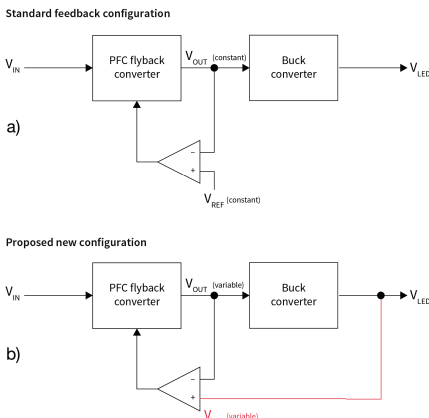


Figure 4: Standard feedback configuration a) and proposed new configuration b)

has been carried out to prove that such feedback configuration does not cause

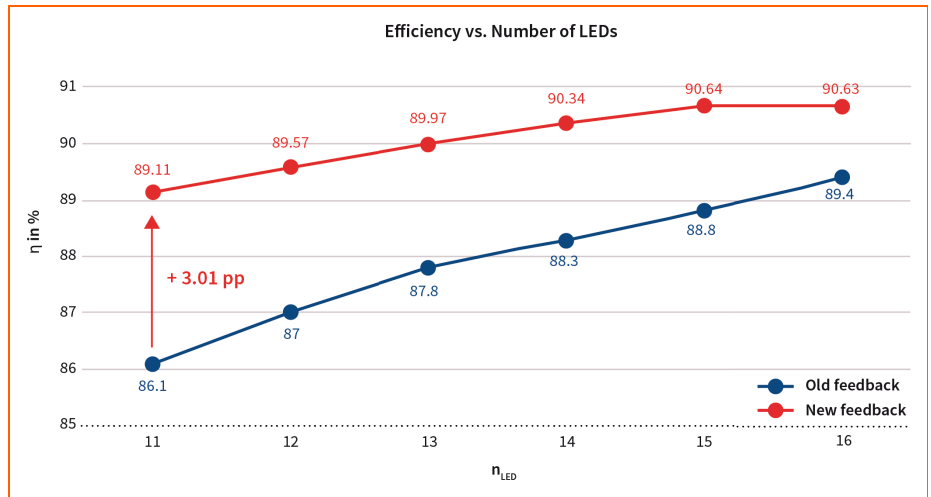


Figure 5: Increase of system efficiency by changing the feedback configuration vs. output voltage

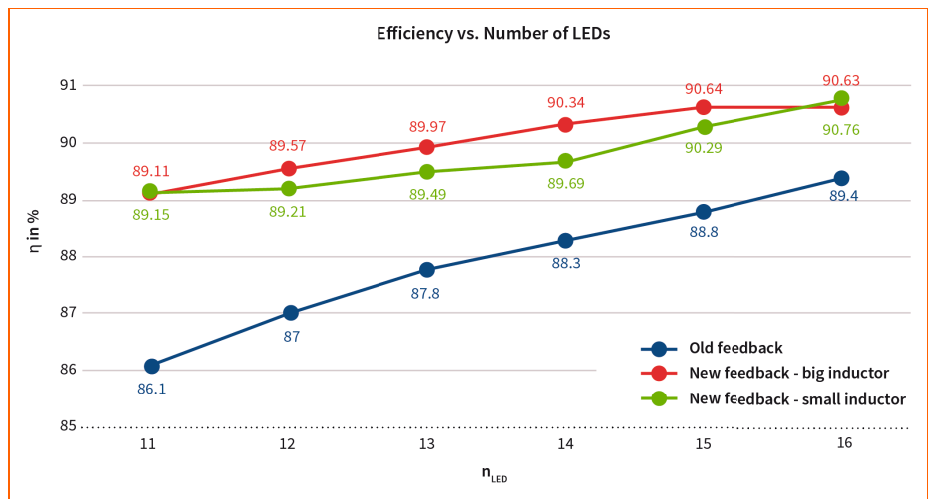


Figure 6: Comparison of system efficiency with altered feedback configuration and original 860 $\mu$ H inductor (red) vs. 100 $\mu$ H SMD inductor (green)

any issues with loop stability [4]. For both, the PFC flyback and the hysteretic buck, the small signal transfer functions have been determined and loop stability analysis has been implemented using MATLAB/SIMULINK. As expected, we found that this type of feedback does not cause any stability issues other than those known from a traditional circuit. Loop response needs to be slow and loop bandwidth needs to be below approximately 20 Hz, as with any other PFC flyback. At the same time, this feedback configuration does not cause any negative impact on the performance of the buck. It is also worth noting that neither ripple suppression nor load response is affected negatively.

How small a difference in  $V_{IN} - V_{OUT}$  can be made is an important question for many designers. This is determined by the maximum duty cycle of the buck. In CCM, duty cycle  $d$  is always  $d = \frac{V_{OUT}}{V_{IN}}$ . Thus,  $V_{IN} = \frac{V_{OUT,Max}}{d_{Max}}$ .

This finally leads to the equation:

$$V_{IN} - V_{OUT} \geq V_{OUT,Max} \cdot \left( \frac{1}{d_{Max}} - 1 \right) \quad (1)$$

ILD8150 has a maximum duty cycle  $d_{Max}$  of 0.97. If the selected maximum output voltage is e.g. 60 V, the minimum difference  $V_{IN} - V_{OUT}$  can be as small as 2 V, leading to extraordinary small inductors.

## Results

The expected efficiency improvement has been validated in a system consisting of an AC-DC converter based on XDPL8218, followed by a hysteretic buck based on ILD8150. This system is described and fully documented in [2]. In the first tests of the proposed solution only the feedback configuration has been altered, exactly as described above. Nothing else has been changed for this first validation. The system efficiency and its increase by altering



# REPRO-LIGHT

the feedback circuit is shown in **Figure 5**. While at maximum output voltage (16 LED  $\approx 48$  V), the increase in efficiency is 1.3%, reaching more than 3% at lower output voltages (11 LED  $\approx 33$  V). Even more exciting are the results displayed in **Figure 6**. Here we changed the output inductor of the buck - a relative bulky 860  $\mu$ H through-hole device was replaced with a 100  $\mu$ H surface mount. Although the latter has an almost five times smaller volume (1.4  $cm^3$  versus 6.4  $cm^3$ ) and a similar factor in the weight (7 g versus 32 g), the efficiency is almost identical. This is an impressive result because it is possible to increase efficiency while at the same time volume, weight, and cost are reduced. ■

## References

- [1] IEEE Recommended Practices for Modulating Current in High-Brightness LEDs for Mitigating Health Risks to Viewers, IEEE Standard 1789-2015, Jun. 2015.
- [2] ILD8150 80 V high side buck LED driver IC with hybrid dimming
- [3] ILD8150 high-frequency operation
- [4] Thomas Altmann, Efficiency Optimization, Size and Cost Reduction of a LED Driver, Master Thesis, Technische Universität München, 2019
- [5] IEC 61000-3-2:2014 Electromagnetic compatibility (EMC) – Part 3-2: Limits – Limits for harmonic current emissions (equipment input current  $\leq 16$  A per phase), 4th edition, 2014
- [6] IEC 61000-3-2:2018 Electromagnetic compatibility (EMC) - Part 3-2: Limits - Limits for harmonic current emissions (equipment input current  $\leq 16$  A per phase), 5th edition, 2018

### ABOUT THE AUTHOR



**Michael WEIRICH, Dr.:** Dr. Michael Weirich received his PhD in solid state physics from the University of Saarbrücken. He has more than 20 years of experience in power electronics design, mainly in lighting applications. Michael started his career as a designer for FL ballast with OSRAM, then joining Fairchild Semiconductor as head of the European application center. For five years he has been the head of the application engineering department for lighting applications of Infineon Technologies AG.

## Initiating Transformation in the European Lighting Industry

Repro-light is a European research project that aims to support the European lighting industry in moving towards a more sustainable and competitive future.

[www.repro-light.eu](http://www.repro-light.eu)



# Designing an Invisible Driver for High-End Track Lights

Until now, bulky LED drivers have required track light designers to choose between lumps on the track, a gear box next to the light head or bulky light heads to include the driver (with additional thermal challenges). Nordic Power Converters (NPC) and Eutrac have joined forces to fix this industry eye-sore. Mickey Madsen, founder and CEO of Nordic Power Converters reports on the result of this cooperation, the new InviTrack driver series. He explains the challenges, demonstrates the solution, and presents measurement results to proof the quality of the product.

**W**HEN two innovative companies join forces for a project, an extraordinary result and solution for a problem can be expected. Up until now, track lights either needed an ugly driver box or the driver was hidden in the luminaire, which adds to the heat load. A new solution hides the driver within the track. But this is not as trivial as it seems. This article explains the challenge, the path to the solution, the needed skills and the value of the new solution and provides a future roadmap for this product line.

## Multi-Disciplinary Challenge

Joined forces and a multi-disciplinary approach were required to put an entire LED driver inside a track. The result: No more lumps on the luminaire or on the track (see **Figure 1**). Thus, enabling more aesthetic and minimalistic designs. This multi-disciplinary challenge requires innovation in both the electronics and the mechanics, only possible with a close collaboration between the parts. This was just possible because of a novel technology for miniaturization of the electronics and the ability to decrease the size by up to five times [1], combined with 30 years experience in the development of mechanics for high-quality solutions for track lights. The first engineering samples of the product were presented at LpS 2019 and the product is now fully launched with ongoing volume shipments.

## High-End Retail and Hospitality

It's all about attracting customers. Design is absolutely key in this process, and no business knows this better than retail. But up until now, there has been a conflict between design and light quality – and the latter is instrumental in making customers stay.

Today's shopper is an unmerciful, fleeting creature, pouncing on even the tiniest of flaws. Add to that an attention span of a five-year-old: Yes, a calm, well-designed environment is severely needed for Homo Sapiens Shoppingensis to stay and focus.

Imagine a high-end retail shop. The goods sold here are presented in spotless, well-crafted displays arranged with great care in order to best present their contents. Design is key, and everything exudes luxury. But all too often, the lighting design has

had to make visible trade-offs in the form of bulky power supplies attached to the otherwise stylish designer lamps. Or live with inferior light quality, where flicker is the primary offender. Aside from being a nuisance, it can cause fatigue, headaches, and several other unpleasant effects.

When a customer enters the shop, first impressions are crucial. Sight, sound, and even smell – opinions and categorizations are formed within seconds. Most important is the visual side, where the sphere of influence reaches far outside the shop. Lighting is instrumental in the window displays, and once inside, it should convey an atmosphere that both reflects the shop's brand and a pleasant, welcoming, environment. Only now the customer begins to evaluate the products. But flicker is an issue with most modern LED lighting, and can cause all sorts of discomfort, repelling other-wise interested customers.

A purchase is only made when the customer feels like making it. And in order to reach that point, people need to focus on the product. The trouble is, flicker is an unseen but very real distraction that draws sensory capacity from the customer while inserting discomfort into the product associations, and may even trigger a desire to leave. We need to feel relaxed and comfortable in order to stay long enough to buy anything.

Decor, ambience and lighting need to induce that feeling as well as be on par with the brand of the shop. Luminaires should provide the exact right amount of light, and the quality of that light should be pleasing.



Figure 1: New invisible driver for high-end track lights



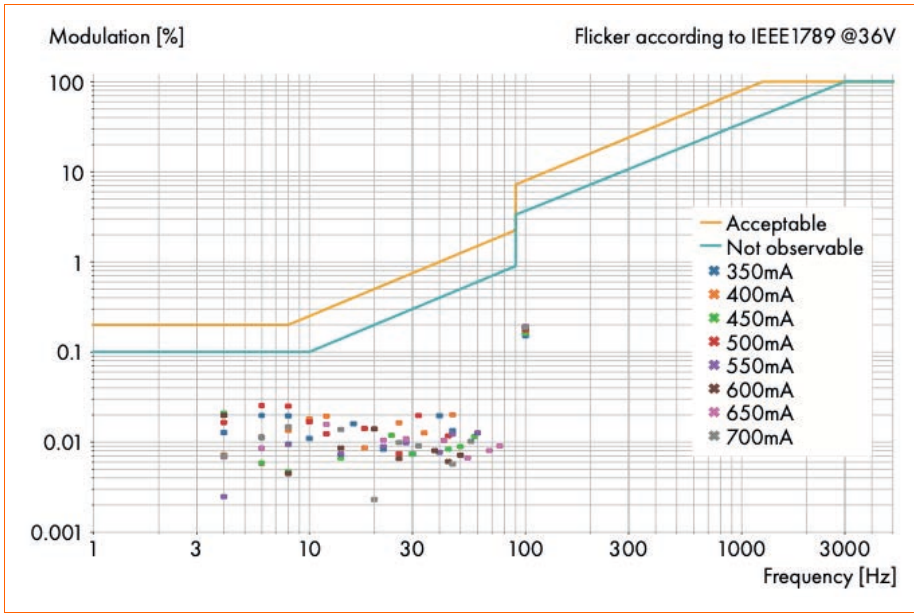


Figure 2: Measurement according to IEEE 1789

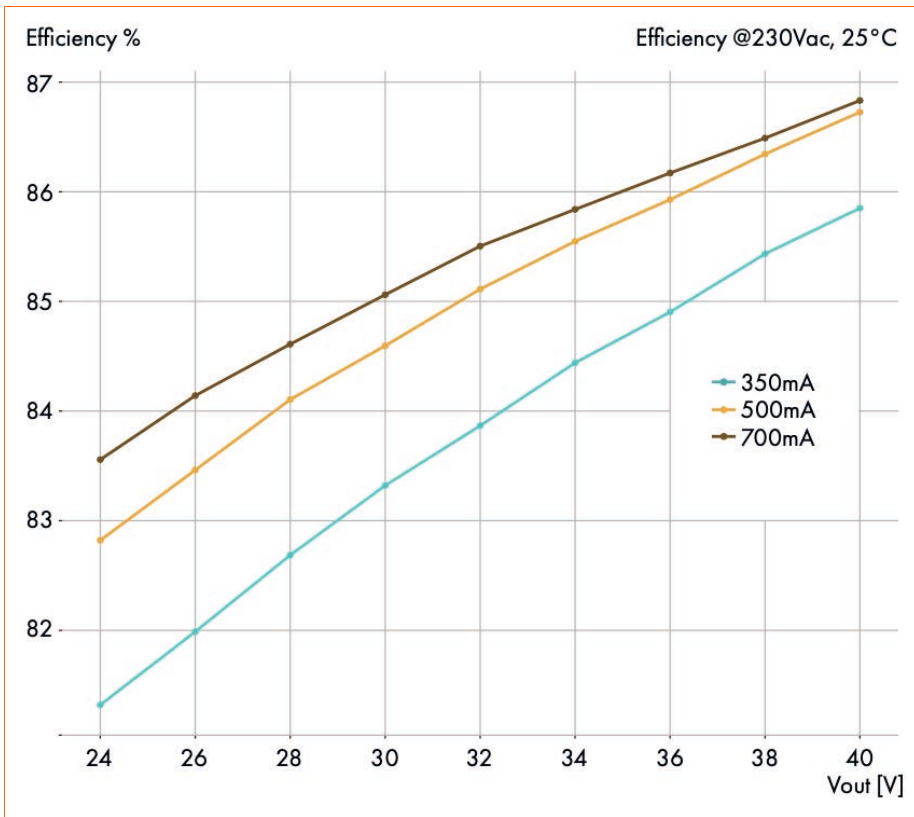


Figure 3: High efficiency at all output levels

## Overall Requirements

New products for the high-end retail and hospitality segments need to meet different requirements. All key requirements are almost equally important.

A designer luminaire should not be compromised by its power supply. The driver must be so tiny that it can be hidden within the design, making it possible to have an

unhindered and visually pleasing lighting design. At the same time the driver must emit a truly calm, flicker free, highly controllable light that will make it effortless to stay in the shop for a long time. Of course, dimming needs to be smooth, deep and have high efficiency.

While design and quality of light is of the utmost importance, there are several other requirements that are expected from any a

premium driver for high-end lighting products.

The temperature needs to be kept low to ensure high reliability and long lifetime. This puts high requirements on both the efficiency and the thermal design. Furthermore, it needs to support current and coming requirements for wired and wireless control. It must cover a wide output range in order to be usable with a wide range of luminaires and enable reduction in the number of stock-keeping units (SKUs). Additionally, it must have best in class performance in terms of inrush, EMC, weight handling and several other aspects as described in the following sections.

## Electrical Innovation

In order to meet all the requirements listed above, several innovations in the electronics were required. The main innovation that enables the development of a driver meeting these requirements is, however, NPC's novel and patented technology for very high frequency resonant converters, previously described in more detail in [1]. The technology enable the driver to operate at higher frequencies, hence reducing the need for passive energy storing elements such as capacitors and inductors. This leads to reduced form factor, more flexible layout and reduced flicker and tighter control.

## Miniaturization

Miniaturization is the main requirement in order to enable the driver to be completely integrated in the track and at the same time keep the length short. This is possible due to the highly elevated operating frequency of the power circuit in the driver.

The frequency is increased 10 times compared to similar products. This leads to a direct reduction in the size of the passive energy storing elements (capacitors and inductors) which constitute the majority of the volume of the electronics.

## Flicker

With the size and thereby design in place, quality of light, and especially flicker, is, as mentioned, the second most important requirement. This is a given fact for most people in the industry, but also the result of a global study conducted by McKinsey [2].

Flicker can be a great nuisance and cause fatigue, headache, and several other un-

pleasant effects for people shopping, working or living under the lights. Hence great care and strong engineering efforts have been put into ensuring not just a low flicker percentage, but also significant margin to pass IEC61010 NOEL limits (see **Figure 2**) [3].

## Temperature

The temperature has a direct impact on the lifetime and reliability of the driver. The lifetime of electronics is, in general, doubled, if the operating temperature is reduced by 10 °C [4]. It is therefore very important to ensure that the driver operates at low temperatures under all conditions. On top of this, the plastics inside the 230 V tracks can only handle 72 °C, so a temperature above this limit adds a risk of failure in the track.

This puts strong requirements on both the efficiency and thermal design of the driver. Thanks to NPC's novel technology, the driver is operated in a manner that ensures almost constant efficiency across load variations. As seen in the plot below, the efficiency is 86.5% at 700 mA and 40 V (28 W) and only drops 5-6% at 350 mA and 24 V (8.4 W) (see **Figure 3**).

At the same time, great care has been put into ensuring a good thermal design. The high efficiency combined with the thermal design ensures that the maximum temperature never exceeds 70 °C. This is below the limits of the plastics in the tracks and 15 °C colder than the semi in-track drivers on the market.

## No Inrush Current

Inrush currents caused by LED drivers have always been a challenge when dimensioning new installations. The immediate charge of capacitors inside the driver at turn on, causes the driver to draw a huge amount of current for a short period, often tens of amperes. This can cause the main fuse to break unless great attention is paid to this issue.

Due to the small capacitors, this problem is, however, eliminated. The inrush is reduced all the way down to 0.5 A, practically removing any need to consider inrush at all. The main fuse can hence be utilized fully; more than 100 drivers can be mounted on a single phase with a standard MCB 16 A type B fuse.

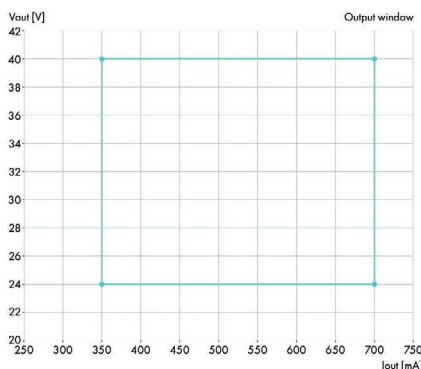


Figure 4: Wide output-window to cover a wide range of luminaires

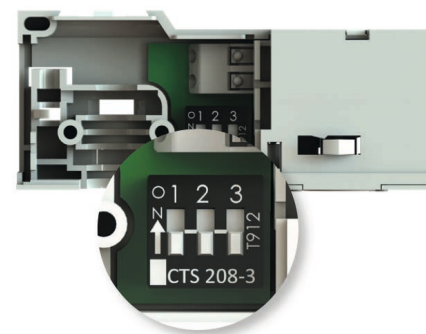


Figure 5: Simple setting of output current via dipswitch

## Wide Operating Range

A wide operating range is, as mentioned, important to enable use across a wide range of luminaires, both different power/current levels and different LEDs with different forward voltages. At the same time this helps to reduce the number of SKUs and hence to reduce costs associated with big stocks.

The driver is designed to cover a wide current and voltage range. The first version, which is a 28 W on/off driver, covers 350–700 mA and 24–40 V as shown in **Figure 4**. More information on coming variants can be found in the roadmap section

(see **Figure 5**). To enable the simple setting of the current within this operation-window, a dipswitch can be accessed through a small lid on the side of the driver. This enables the simple setting of the output current in steps of 50 mA.

## EMC

Compliance with requirements such as EMC, PF and THD from CE, ENEC etc., is, of course, also very important. In particular, EMC can be a challenge for track lighting, as the track can serve as a big antenna and proximity of the drivers to the mains wires can create capacitive coupling.

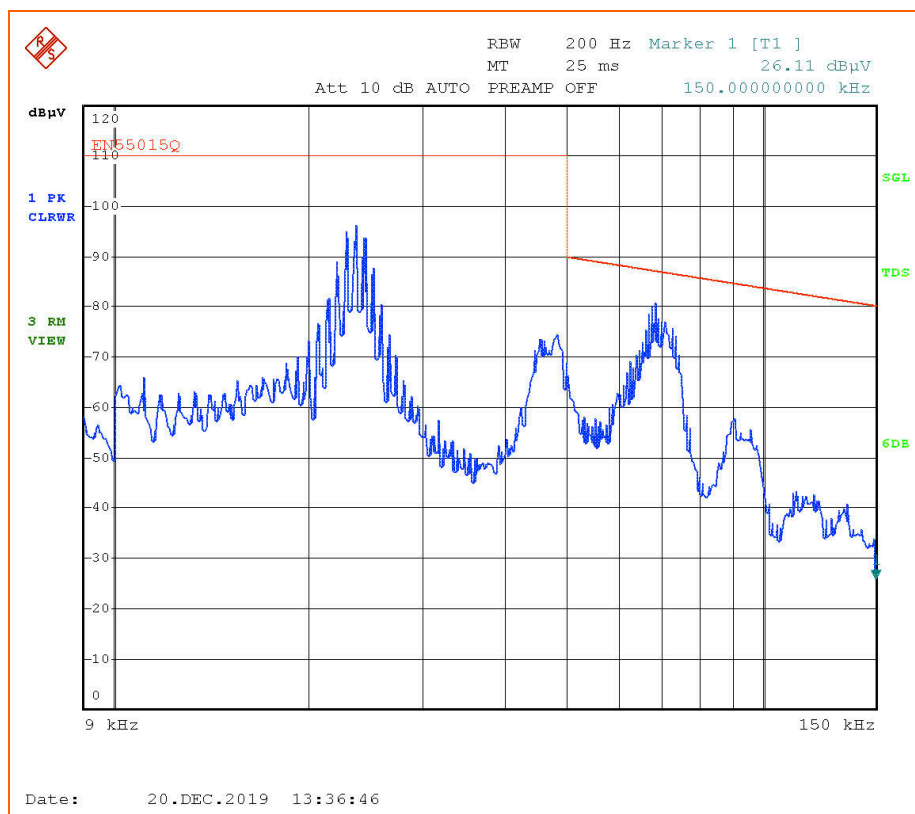


Figure 6: Extensive EMC measurements have been performed, both low and high frequency conducted and radiated

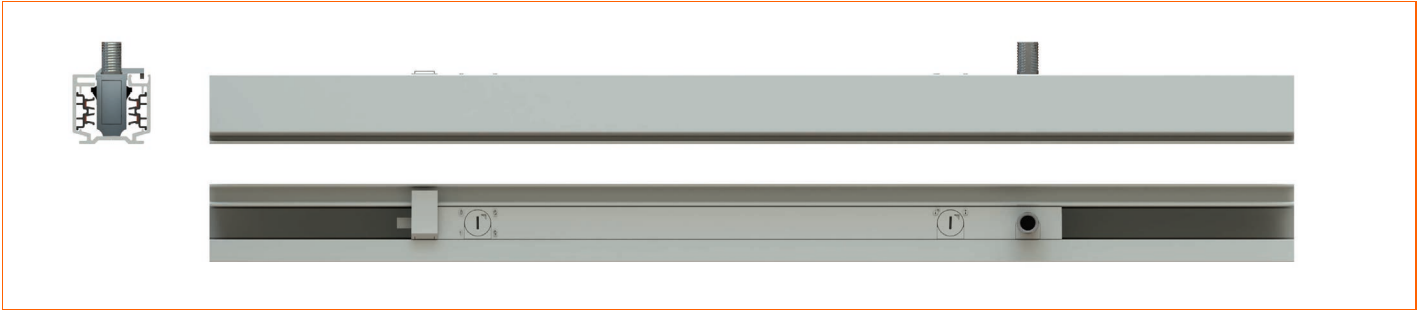


Figure 7: Driver completely integrated in track



Figure 8: Locking mechanism for screwdriver, also available in a version with turn knob

Through extensive design efforts and testing in tracks from all major manufacturers, it has been ensured that new solution passes the EMC requirements with good margin (see **Figure 6**).

## Mechanical Innovation

While design is the most important requirement, innovation in the mechanics is also needed. The product needs to look great in the final installation and at the same time be easy to use and compatible with existing tracks and lighting fixtures.

### Completely In-Track

The vision was to make a family of drivers for track lights that is completely integrated in the tracks. It was hence a strict requirement that the AC connector and phase selector were redesigned to be fully flush with the track (see **Figure 7**).

This has been achieved, and the result is a novel patent pending solution that utilizes a camshaft. This solution has been tested under power with minimum 100 switching cycles accordingly to EN 60 570. A small compromise is required to mount the driver. The two locks need to be turned (see **Figure 8**). This requires either a screwdriver or a small turn knob. Both solutions have been made available so that the user

can make the small trade-off between having a product that is fully flush with the track and a product that can be mounted without the use of tools.

### Fit All Tracks

The new solution has been designed to fit in all major track systems (see **Figure 9**). This is a great challenge as the height, width and construction varies from different manufacturers. By designing for the smallest dimensions and using the novel AC connector with slightly flexible connectors, it has, however, been made possible.

As the driver is completely integrated in the track, there is a risk that the user could mount the driver in the wrong direction, hence connecting it to two phases instead of a phase and neutral. A small 'arm' has been designed on top of the driver, to ensure the correct orientation in all tracks.

### Weight

The driver is designed to enable an aesthetic and minimalistic overall design of track lights. The driver is hidden in the track and the luminaire just needs to include the LEDs, optics and sufficient cooling for the LEDs. Hence the weight of the luminaire can be kept low even when utilizing the full power rating.

To ensure good margin and high reliability, the mechanics have, however, been designed to hold luminaires up to 3 kg (tested according to EN 60 570 with five times the weight). In addition, the driver has a lock in each end. This double mechanical locking ensures that the driver is always fixed tightly in the track, and thus that driver-s/adaptors hanging slightly from the track can be avoided.

### Easy Switch

It is important that it is easy for manufacturers to switch from incumbent solutions to the next generation. The driver has thus been designed to use retaining collars with standard M10 and M13 thread. The retaining collar also enables 360° rotation with internal stop, again to avoid parts on the top of the driver and ensure a sleek design when the driver is mounted in the track. The in-track drivers are available in three colors to match the track and luminaires and be even more invisible.

### Powering a Brighter Future

Several aspects make the new solution ideal when considering the environment, and not just the environment of the room illuminated by the track lights. While all drivers are fairly efficient at full power, most other drivers suffer power losses when

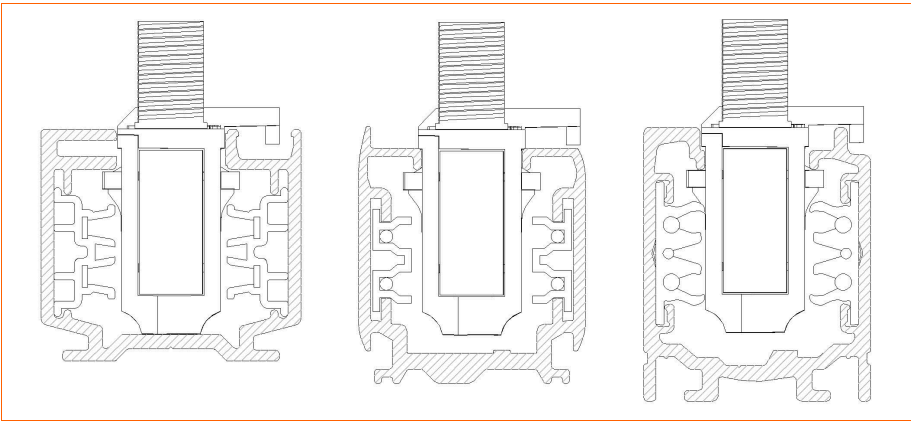


Figure 9: The driver mounted in tracks from Eutrac, Global and Stucchi



Figure 10: Aesthetic and minimalistic track light using the presented driver designed by innovative Hamburg based company

used at less than full power. A patented technology leads to considerably greater efficiency at all output levels, conserving energy. This adds up quickly and converts to actual financial savings, which is of course always welcome. But more importantly, NPC's drivers will help save tons of CO<sub>2</sub>.

Furthermore, it uses less raw material than other solutions, especially rare earth materials (magnetic core materials) and plastics. Combined with improved lifetime and reliability, this reduces both the material consumption when making the product and the waste generated by failed products. The wide output window, simple current setting and easy mounting of luminaires with retaining collars also make it convenient to change just the driver or the luminaire. This can be both in case of failure in one of the parts, or if one part needs to be upgraded, e.g. luminaires with new design or better LEDs or a driver with a new control interface.

## Roadmap

The first product in the new driver family is a 28W on/off driver. This product was first shown at LpS in 2019 and is now fully launched with volume shipments. Later, in 2020, the family will grow, with both DALI and higher power versions. The future

roadmap also includes smaller versions, wireless control interfaces, sensors and solutions for tunable white/human centric lighting.

All fully in-track and with the same premium performance. The roadmap also includes a completely new track system. A slim single phase 230V track. This combines the slim profile of DC tracks with the high efficiency and unrestricted power of 230V tracks. Add to this the miniaturized in-track drivers without inrush current, and you have a sleek, efficient, easy to use and affordable track system.

## Summary & Conclusions

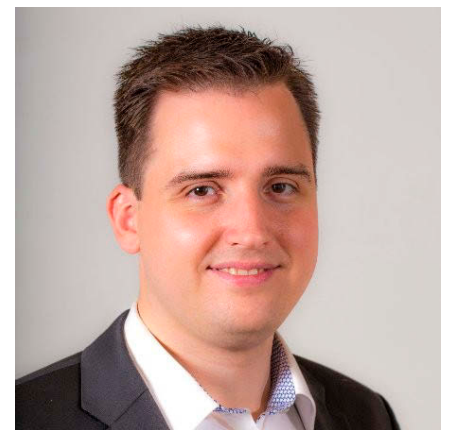
The article has described the needs of the high-end retail and hospitality market and how they translate into product requirements. Furthermore, the challenges and solutions to meet these requirements have been presented in detail. The driver concept for high-end retail and hospitality track lights (see **Figure 10**), presented in this article enables a combination of design and quality performance which has not been possible with incumbent solutions. The presented roadmap shows the potential of the concept and that the technology is future proof. While the coming members are already in development, the discussion about the future needs for (track) lighting

has just began. However, strong collaboration and exchange of knowledge across the industry is the only way to ensure the best possible solutions for the next generations of lighting. ■

## References

- [1] M. Madsen. LED Driver Miniaturization – Opening New Opportunities for Solid State Lighting. LpR issue 62. Jul/Aug 2017.
- [2] Lighting market report predicts strong growth for LED lighting (MAGAZINE), LEDs Magazine, September 2011.
- [3] 1789-2015 - IEEE Recommended Practices for Modulating Current in High-Brightness LEDs for Mitigating Health Risks to Viewers, Approved September 2008, Published May 2015.
- [4] S. Somers. Thermal Management Part 1: How Hot Is Too Hot?: [https://www.extron.com/article/thermalmgt1\\_ts?TS\\_PD\\_101\\_R0=08c7c0b6e6ab2000bd2678cf018f9e40160b55da693f06f610ec45b4a5adc15a65771200b1c0cace0828e7673e1430002eb2428ed629ff817e878dd7eaccf1b012de5b2789ebbbb634009021e94388d63898aa3f1078308b0c7f16e8f811a218](https://www.extron.com/article/thermalmgt1_ts?TS_PD_101_R0=08c7c0b6e6ab2000bd2678cf018f9e40160b55da693f06f610ec45b4a5adc15a65771200b1c0cace0828e7673e1430002eb2428ed629ff817e878dd7eaccf1b012de5b2789ebbbb634009021e94388d63898aa3f1078308b0c7f16e8f811a218)

## ABOUT THE AUTHOR



**Mickey MADSEN, Dr.:** Mickey Madsen has a strong technical background with both a MSc.EE and PhD in power electronics and several scientific publications and patents. He has received several awards, among them Semikron Innovation Award from the European Center for Power Electronics and PhD of the year award from the Technical University of Denmark. Mr Madsen is the CEO and founder of Nordic Power Converters, which is based on his technical breakthrough in power converters offering highly miniaturized LED drivers with increased reliability and extended lifetime. As CEO he is involved in all aspects of the business, but with a high focus on pushing the technology further, strategic partnerships, product roadmap and intellectual property.

# The Global Information Hub for Lighting Technologies

LED professional is the comprehensive publication and platform, connecting experts in the design, testing and production of the latest lighting technologies information from around the world.

MORE THAN  
**31,500**  
READERS



**GET YOUR FREE E-MAGAZINE**  
[www.led-professional.com/free](http://www.led-professional.com/free)



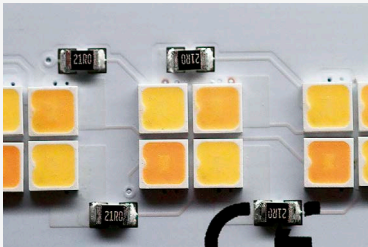
**LED**  
professional

[www.led-professional.com](http://www.led-professional.com)

powered by Luger Research e.U.



## Cover Page



Artwork: Thomas Klobassa

Main Image: Arno Grabher-Meyer

The shown segment from Lumitronix's LED module based on SSC's SunLike won the LpS Best Application Technology Award

## Annual Subscriptions

### LpR Digital Magazine

- 6 issues
- pdf download
- high resolution pictures and graphs printable
- commercial use
- access to all previous issues
- Euro 78.80

### LpR Printed & Digital Magazine

- 6 issues
- pdf download
- high resolution pictures and graphs printable
- commercial use
- access to all digital previous issues
- shipping costs included
- Euro 97.80

## Subscribe



<https://www.led-professional.com/subscription>

## Advertise



<https://www.led-professional.com/advertise>

## Preview May/June 2020 LpR 79 Future Proof Systems & Solutions

Interview with Hani Kanaan from  
CEA Leti about Micro LEDs  
Micro LEDs are the latest development in  
SSL. ■

## Degradation of Green High- Power LEDs – Influence on Color Stability of Multi-Channel Luminaires

The influence on RGB and RGBW systems  
in order to guarantee color stability along the  
Planckian locus are compared. ■

## New Flexible Luminaire Systems Based on Atmospheric Plasma Metallization

In this article the author demonstrates new  
innovative flexible large area luminaires at  
high volumes in the roll-to-roll production  
method. ■

## Current Trends in LED Phosphor Development

This paper gives an overview of today's typical  
LED phosphors with their product system,  
synthesis, performance, respective areas,  
performance and application solutions. ■

## Thermal Analysis of an LED De- sign – A Case Study

This article will explain the challenges in  
electronics design and dive into how to in-  
vestigate heat flow and visualize temperature  
distribution to develop the best cooling strategy  
for a new product, while saving time and  
costs. ■

## Cost and Benefit of Attempting Future Proof Solutions

The author discusses whether there is a def-  
inition, if we can we tell what future proof  
actually means without substantial and sound  
knowledge of the future and what the typical  
requirements are. ■

## Lighting Controls – Futureproof- ing and Open Standards Lead the Way

The article shows that a conscious strategy of  
futureproofing can help reduce risk percep-  
tion among buyers and secure contracts. ■

## Imprint

LED professional Review (LpR), ISSN 1993-890X

## Publishing Company

**Luger Research e.U. | © 2001-2020**

Institute for Innovation & Technology  
Moosmahdstrasse 30, A-6850 Dornbirn, Austria, Europe  
info@lugerresearch.com, www.lugerresearch.com  
P +43 5572 39 44 89 | F +43 5572 20 60 70

### Publisher

Siegfried Luger +43 699 1133 5570  
s.luger@lugerresearch.com

### Editors

Arno Grabher-Meyer, Editor in Chief +43 699 1133 5518  
a.g-m@led-professional.com

Dr. Günther Sejkora

+43 699 1133 4343  
g.sejkora@lugerresearch.com

Sarah Toward

+43 699 1133 5521  
sarah.toward@lugerresearch.com

### International Account Manager

Christine Luger +43 699 1133 5520  
c.luger@lugerresearch.com

### International Solution Manager

Sarah Toward +43 699 1133 5521  
sarah.toward@lugerresearch.com

### China, Hong-Kong

Lolo Young +852 9792 2081  
lolo@castintl.com

### Germany

Armin Wezel +49 30526 891 92  
armin@eurokom-media.de

### India

Priyanka Rai +91 124 4787331  
priyanka.raibinarysemantics.com

### South Korea

Jung-Won Suh +82 2 78 58222  
sinsegi@sinssegimedia.info

### Taiwan

Leon Chen +886 2 256 81 786-10  
Jeon@jkmmedia.com.tw

### Benelux, France, Ireland, Scandinavia, UK

Zena Coupé +44 1923 85 25 37  
zena@expomedia.biz

### US East - Key Accounts

Karen C Smith-Kernc +1 717 397 7100  
KarenKCS@aol.com

### US West & Canada - Key Accounts

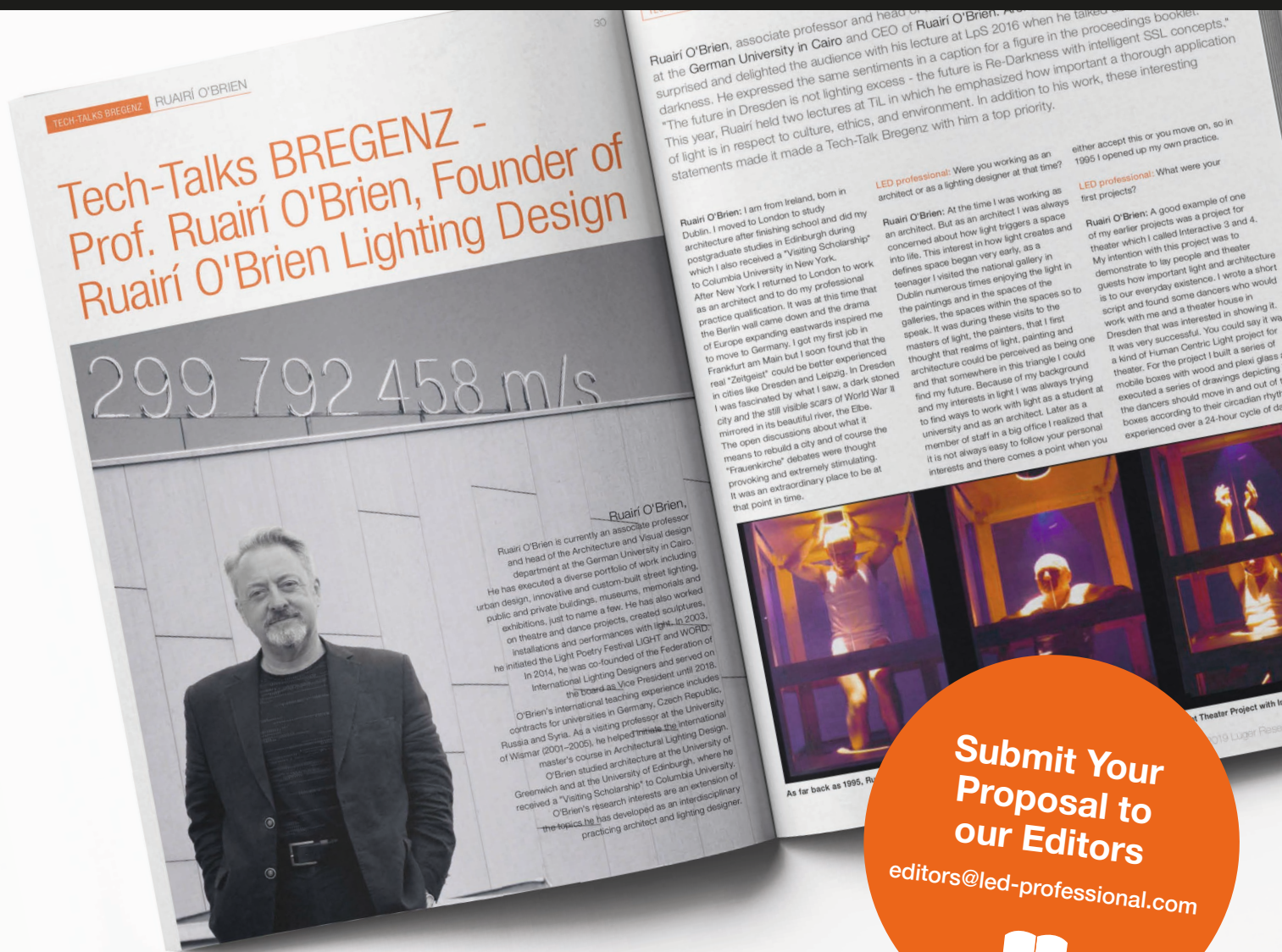
Alan A. Kernc +1 717 397 7100  
AlankCS@aol.com

### North American Sales Representative

Lesley Harmoning +1 218 686 6438  
lesley@hmediainc.com

## Copyrights – Luger Research e.U.

The editors make every reasonable effort to verify the information published, but Luger Research e.U. assumes no responsibility for the validity of any manufacturers, non profit organizations or individuals claims or statements. Luger Research e.U. does not assume and hereby disclaims any liability to any person for any loss or damage caused by errors or omissions in the material contained herein, regardless of whether such errors result from negligence, accident or any other cause whatsoever. You may not copy, reproduce, republish, download, post, broadcast, transmit, make available to the public, or otherwise use LED professional Review (LpR) content without prior written consent from Luger Research e.U. ■



# Showcase Your Lighting Excellence in 2020

ISSUE N°	IN THE SPOTLIGHT	ABSTRACT DUE	ARTICLE DUE
77 Jan/Feb	Disruptive Technologies & Approaches	Oct. 21 <sup>st</sup> 2019	Oct. 28 <sup>th</sup> 2019
78 Mar/Apr	Technologies For Health & Well-Being	Dec. 16 <sup>th</sup> 2019	Jan. 07 <sup>th</sup> 2020
79 May/Jun	Future Proof Systems & Solutions	Feb. 24 <sup>th</sup> 2020	Mar. 02 <sup>nd</sup> 2020
80 Jul/Aug	Environmentally Friendly, Lasting Designs & Approaches	Apr. 24 <sup>th</sup> 2020	May 04 <sup>th</sup> 2020
81 Sept/Oct	Technologies For Visual Performance & Cognition	June 22 <sup>nd</sup> 2020	July 06 <sup>th</sup> 2020
82 Nov/Dec	Technologies For Special Tasks & Applications	Aug 17 <sup>th</sup> 2020	Aug 24 <sup>th</sup> 2020



# Your Comprehensive Guide to the Lighting World

The Global Lighting  
Directory 2020

Published by  
LED professional &  
Trends in Lighting

[www.GLD.lighting](http://www.GLD.lighting)