

**LED**  
professional

[www.led-professional.com](http://www.led-professional.com)

ISSN 1993-890X

# Review

LpR

*The technology of tomorrow for general lighting applications.*

Mar/Apr 2009 | Issue

**12**



## LED Applications & Lighting Systems



## The Third Industrial Revolution



We are at the beginning of what has correctly been called the "third industrial revolution" – the rapid development of an entirely new energy system. We can expect a massive shift towards a carbon-free electricity system, with huge pressure to reduce energy consumption and transport on the basis of renewable electricity. The United Nations predicts that the global population will increase from 6.5 billion today to 9 billion by 2050, with most of this growth coming from the developing world. Today, about 1.6 billion people have neither modern lighting nor electricity. For ecological reasons the increased energy demanded has to be supported by environmentally-friendly technologies.

The lighting segment is responsible for approximately 20% of the worldwide electricity consumption. One pillar for the goal of reducing this amount is to ban the use of incandescent bulbs; even attempts at creating satisfactory efficient incandescent bulbs have failed. Could Compact Fluorescent Lamps (CFL) be the answer? The problem is that CFLs contain tiny amounts of mercury. Individually, they do not add up to much, but when billions are calculated, the risk of mercury spilling into our landfills is too great. Regulating recycling attempts would be far too difficult and its implementation is met with great skepticism. The most viable alternative available on the market are LEDs, but the cost of production is too high; at least until manufacturers can break out of a niche market and create a great enough demand for general lighting purposes.

Nowadays only a small percentage of the general lighting market (approx. 40,000 tera-lumens) is covered by LED applications. The market has extreme potential. LED lighting systems gain not only from high system efficacies, but also from the reduction of the luminary size, shape flexibility, simplicity of control and the ability of having the "right light" in the "right place" at the "right time" – a complete flexibility in lighting parameters, which was not possible 10 years ago.

One of those areas, which this flexibility of light will be needed in, is the focus of the European Project "Aladin", which studies the influence of light on elderly people. A detailed report of this study is covered in this issue.

The Mar/Apr 2009 *LED professional Review (LpR)* issue highlights LED applications and systems showing some aspects of how to apply LED technology in modern lighting systems. We would be delighted to receive your feedback about *LpR* or tell us how we can improve our services. You are also welcome to contribute your own editorials.

Yours Sincerely,

A handwritten signature in black ink, appearing to be 'S. Luger', written over a horizontal line.

Siegfried Luger

Publisher

## Imprint

LED professional Review (LpR)

ISSN 1993-890X

### Publisher

Luger Research e.U.  
Institute for Innovation & Technology  
dep LED professional  
Rhombergs Fabrik  
A 6850 Dornbirn, Austria / Europe  
phone +43 5572 394 489  
fax +43 5572 394 489 90  
editors@led-professional.com  
www.led-professional.com

### Publishing Editors

Siegfried Luger  
Arno Grabher-Meyer  
Chrystyna Lucyk

### Account Manager

Silvia Girardelli

### Front-page picture

ALADIN Project

### Copyrights – Luger Research e.U.

The editors make every reasonable effort to verify the information published, but Luger Research e.U. assumes no responsibility for the validity of any manufacturers, non profit organisations or individuals claims or statements. Luger Research e.U. does not assume and hereby disclaims any liability to any person for any loss or damage caused by errors or omissions in the material contained herein, regardless of whether such errors result from negligence, accident or any other cause whatsoever. You may not copy, reproduce, republish, download, post, broadcast, transmit, make available to the public, or otherwise use of LED professional Review (LpR) content without the prior written permission from Luger Research e.U. – Institute for Innovation & Technology, Austria. ■



### LED professional Review (LpR) – Subscription

#### LpR Digital Magazine – free version

- pdf download
- view only, low resolution
- private use

#### LpR Digital Magazine – full version annual subscription

- pdf download
- pictures and graphs in high resolutions, printable
- 6 issues
- access to all previous issues
- commercial use
- Euro 78.80

#### LpR Printed Magazine – annual subscription

- 6 issues
- Euro 158.40

#### Send E-mail to:

editors@led-professional.com

#### Next LpR Issue – May/June 2009

- LED Thermal Management

# Content

<b>Editorial</b>	p1
<b>Imprint</b>	p2
<b>Project News</b>	p4
<b>Product News</b>	p6
<b>Research News</b>	p14

## ■ Project

<b>LED Makeover, Yielding 90% Energy Saving</b> by Alexander Mueller, Future Lighting Solutions	p16
--	-----

## ■ Application

<b>ALADIN – An Advanced Lighting System for Improved Health and Wellbeing</b> by Edith Maier, Walter Ritter, Univ. of Appl. Sciences Vorarlberg, and St. Gallen	p20
<b>A New White Light Solution Using an End-User Design Approach</b> by Gary Trott, Cree LED Lighting	p28
<b>Merging Technology and Biomorphic Design</b> by Christie Liu, BComm Marketing & Lumolar	p32
<b>Light 2.0: LEDs Create an Entirely New Generation of Lamps</b> by Andreas Biß, Sharp Microelectronics Europe	p34
<b>The Future of LED Illuminators</b> by John Popovich, Column8	p38

## ■ Thermal Management

<b>Ceramic Simplifies Heat Dissipation</b> by Dr. Armin Veitl, Altair Engineering GmbH	p45
---	-----

## Advertising Index

EDISON	p C2
RADIANT IMAGING	p 5
OSRAM	p 7
CREE	p 13
VOSSLOH SCHWABE	p 18
SHARP	p 19
SRM-PRINTTECHNIK	p 30
TAITRONICS	p 31
LED LIGHTING TAIWAN 2009	p 37
GZ. INT. LIGHTING EXHIBITION	p C3
EUROLED 2009	p C4

## Project News

### Seoul Semiconductor Acriche in Saint Petersburg, Russia

Seoul Semiconductor (CEO Chung Hoon Lee) announced a project to replace outdoor lightings of a Senator business center with an exclusive solid state light. Acriche has been developed by Vitrulux Oy, a Russian lighting expert company.



Seoul Semiconductor's AC-driven Acriche decorates the skyline

According to Senator's spokesman, first Acriche is excellent in controlling light features and viewing angles compared to conventional fluorescent lightings. Also, while the lifespan of existing fluorescent lightings is less than 10,000 hrs, Acriche lighting fixtures can be operated for over 30,000 hrs. This feature could steeply cut maintenance fees. Additionally, while the existing T5-type of fluorescent lightings consume 36W, Acriche lighting fixtures use only 20W with 45% in energy savings.

Seoul Semiconductor's technical manager said that, while the existing fluorescent lighting does not function properly under -10°C, there is no change in the Acriche lumens and lifespan under the same weather conditions. Therefore, he recommends Acriche as an appropriate light source for outdoor lighting.

Seoul Semiconductor's Acriche is an AC/DC converterless semiconductor light source driven at AC, differentiated from general DC-driven LEDs requiring converters. This feature enables Acriche to operate for over 30,000 hrs and provide a solution to the problem in the lifespan of LED shortened by converters with 10,000 to 20,000 hrs of lifespan. Therefore, Acriche maximizes the lifetime-related advantage of LEDs. Also, Acriche provides customers with a simple and easy design as well as installation.

A Seoul Semiconductor's official said, "Despite a dull economy, the demand for Acriche is increasing steeply worldwide due to its brilliant technology. We are continuing to invest in our R&D in 2009 so that innovative products like Acriche can be realised." ■

### Philips Transforms Raymond James Stadium for Super Bowl XLIII

Raymond James Stadium, Tampa's host venue for the Super Bowl, was temporarily illuminated with state-of-the-art LED technology as part of a city-wide beautification effort for the championship game, held on February 1, 2009.

Design firm Infinite Scale Design was responsible for designing and branding the overall look of the city of Tampa for Super Bowl XLIII. Working with lighting designer Dall Brown, they chose to accentuate the stadium's exterior crown with colorful, customizable lighting. Approximately 70 ColorReach Powercore fixtures were used in total, with just two required to evenly illuminate each 40x80 foot bay. Mounted on a concrete cross beam from within the stadium, the fixtures project light onto the underside of the stadium's upper 30 rows.



Special illumination of Raymond James Stadium for the Super Bowl, from January 27 to February 01, 2009 (Photo Credits: Stephen Kovich)

Each fixture was individually programmable and could produce millions of colors and color-changing effects, which enables the stadium to display the colors of the opposing teams as well as providing dazzling lighting effects. Capable of projecting over 500 feet, the ColorReach Powercore fixtures made the stadium visible from the air and from multiple viewpoints across the city.

"When it comes to LED lighting, Philips Color Kinetics is known for its quality and reliability, which are critical for this globally televised event. ColorReach Powercore delivered the high intensity required for this project, along with unlimited color choices and low power consumption."

ColorReach Powercore supported the National Football League's recent efforts to make the Super Bowl event more "green." The temporary lighting scheme required minimal energy; just 290 watts per fixture. Even when operating at full intensity, ColorReach Powercore consumes less than half the energy of a typical coffeemaker. By comparison, the traditional metal halide fixtures typically used in such exterior projects consume 1,600 watts each and require gels to produce colored lighting. This allowed the stadium to be illuminated in a smart and sustainable way. ■



## The best solutions for any LED measurement application!

Whether you are designing or using LED luminaires, arrays, or displays, an accurate characterization of visual performance is vital to assess design choices, to make device selections, and to improve system performance.

Radiant Imaging provides the most extensive set of luminance and color measurement solutions in the industry specifically designed for LED applications. Source Imaging Goniometers for measuring near-field models for optical design. ProMetric Imaging Colorimeters for measuring illumination distributions. Imaging Spheres for measuring luminous intensity distributions. And a broad array of ProMetric Application Software for laboratory, factory, and field applications - including LED video display correction.

These measurements solutions provide you with the best fit to your application - saving time and reducing cost. And with a shared technology base and world-class technical support, Radiant Imaging solutions are easily extended to new applications.

For more information on Radiant's suite of LED measurement solutions, contact us at +1.425.844.0152 or [sales@radiantimaging.com](mailto:sales@radiantimaging.com).

Ask for a copy of our White Paper on LED measurement applications!

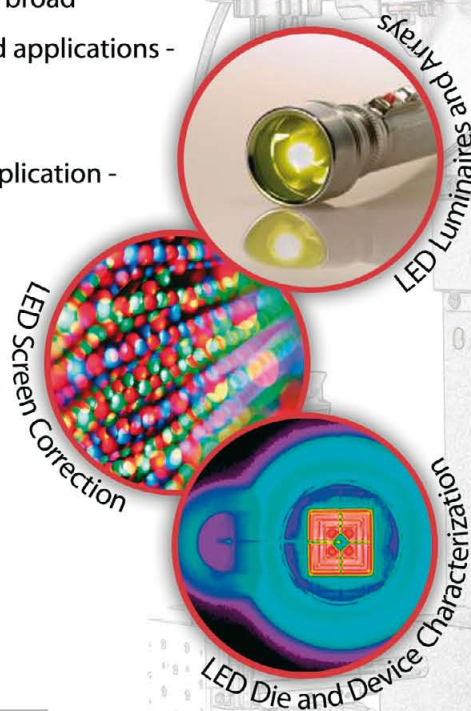

**RADIANT IMAGING**

## Product News

### Simple Architectural Color Changing Control

The Martin Professional Colorfox VX01 is the first lighting controller specifically designed for architectural use with dynamic color changing fixtures. This incredibly simple control solution allows users to customize and personalize a variety of architectural lighting settings.

Colorfox features an attractive, tactile design that enables it to fit into nearly any design environment. Its user-friendly interface allows even inexperienced users to access the benefits of dynamic light.

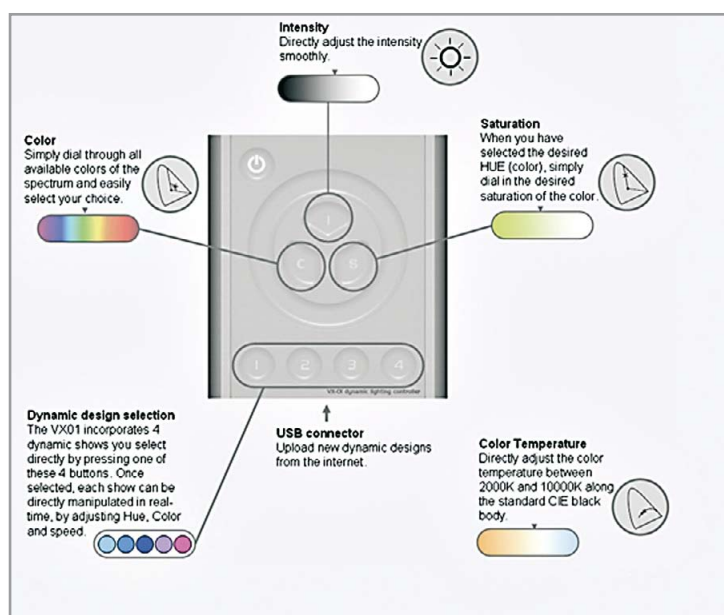

Functionality of the simple-to-use and intuitive Colorfox VX01

#### Main Features:

- Touch-sensitive dial with acoustic and visual feedback
- 4 memory buttons to run/store/adjust your favorite looks and dynamic scenes
- Select any color fast and easily by scrolling the color wheel
- Connects directly to DMX via RJ45 and controls up to 170 fixtures or zones (maximum 512 channels)
- Easily wall-mounted using the included bracket
- For straightforward control of Martin architectural luminaires

This intuitive controller allows for easy playback of static and dynamic scenes and provides a simple-to-use interface for users to alter the hue, saturation and intensity of their surroundings. Change color and speed by the mere click of a button and then re-save it to any preset.

Color temperature can be easily adjusted from 2000K-9000K to match different luminaire types (RGB or CMY) for identical and consistent color matching, making it easy to replace any fixture without re-programming designs.

Colorfox VX01 connects to any PC via USB for easy setup and uploading of new scenes using PixMove design software. It includes a list of pre-defined designs and the capability to create custom solutions with fast and direct access to all features. The software's Visual Designer also serves as an offline editor allowing designs to be pre-programmed off site and later uploaded to any device via USB. ■

### AsianSignals Introduces the Rebel Spot 36

The Rebel Spot 36 is AsianSignals' continuing exploration into leveraging FR-4 copper laminate techniques in achieving a low cost, easy to use, and effective mounting solution for the Luxeon Rebel LED.

All of the LEDs are arranged in tight formation inside a 34mm circle. This allows the board to accept off-the-shelf collimating lenses and be fit onto a low cost CPU heat sink. The LED circuits and layout pattern are sufficiently randomized to efficiently mix color between any of four circuits. LEDs can be mounted in combinations of three, six, or nine per circuit. Circuits can be cascaded for 12- 24- 36- or 48- volt service. The board is multi-layered and employs heavy copper plating with more than 1,000 thermal vias.

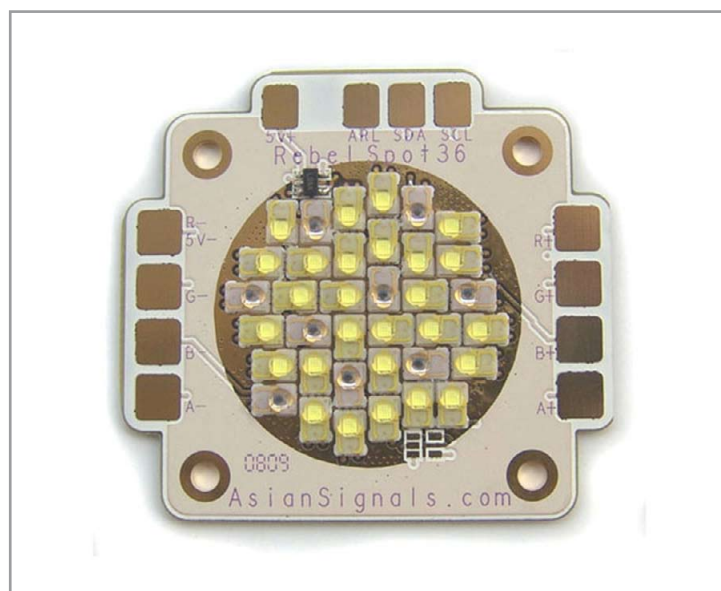

AsianSignals' Rebel Spot 36-board

New to this board are built-in locations for two digital temperature sensors. Now, a manufacturer with an available I2C bus can accurately monitor LED temperature right next to the LED array.





## LEDs for General Lighting Solutions

OSRAM Opto Semiconductors empowers lighting solutions for today and tomorrow

Opto Semiconductors

**OSRAM**

Captive mounting holes for solid effective mounting and thermally isolated pads are employed in order to easily solder wires to the board. With some practice, LEDs can be hand soldered to the board.

The product is an experimental offering that is within 90% of the company's goal in handling 4,500 Lumens (tested with Cool White Rebels LXML-PWC1-0100). For arrangements of color, the board concurrently handle any combination of Luxeon Rebels effectively. ■

## New Sharp-LEDs: Small, Efficient and Bright

In addition to the LED lighting Module "Zenigata", Sharp plans to expand its LED line-up with white and RGB high brightness chip LEDs. It consists of 21 different types of white light LEDs and 11 different types of monochrome and RGB LEDs. The company notes they offer a high light performance of up to 90 lumen per watt. In addition, they have an extremely long service life: depending on the type, 40,000h at a substrate temperature of up to 80°C cause extended maintenance intervals to contribute to low operation costs in addition to high energy efficiency.



Sharp LED portfolio overview

Sharp notes that the new LED components are made for versatile application areas, which require a high amount of brightness with a compact form factor at the same time. This gives designers more freedom and flexibility when creating illumination systems. Besides common applications such as backLighting for LCDs or keypads, chip LEDs are used, for example, for general illumination, surgical spotlights, as status signals for industrial applications and for indoor mood lamps, as well.

Due to different phosphor mixtures, the LEDs reach a colour rendering index (CRI) of up to 90 for a highly genuine reproduction of colours and details. Colour temperatures of white light LEDs are in the range of 2200K to 11500K. They are available with radiation angles of 120° and 130°. The white LEDs generate a light output of up to 6,4 cd at a power consumption of 0,01 to 0,2 W.

In any case the white light LED chips are in a convincingly compact design, as a standard 3228 package with a height of 1,9mm and 0,9mm as well as ultra small package of 1,6x 0,8mm with a minimum height of 0,2 mm. Since they require only a little space, the white LEDs are predestined to replace conventional lamps in commercial applications like shop and decoration lighting. But they will also be used as an illuminant in solar driven and normal streetlights.

Furthermore, Sharp is offering brick-shaped multi-chip SMD LEDs, or the so-called Flash Bricks that can be processed by reflow soldering. Despite their small dimensions of 2,6x1,6x0,7mm, they provide a high light performance of up to 39 lumen. They are particularly suited for applications which require a high brightness providing only a little space for design-in at the same time. Flash LEDs as well as Side Shoot LEDs which are used for mobile phones and other portable application, complete the line-up of white light LEDs. ■

## Luminus Introduces SST-90 White PhlatLight LED

Luminus Devices, Inc. announced the availability of the SST-90 white PhlatLight® LED, a large white LED chip in a new surface mount (SMT) package. The SST-90 combines the benefits of high power and efficiency, enabling lighting fixture OEMs to replace bulbs and LED arrays with a single PhlatLight LED. For LED customers, this results in simplified designs, lower costs and faster time-to-market.

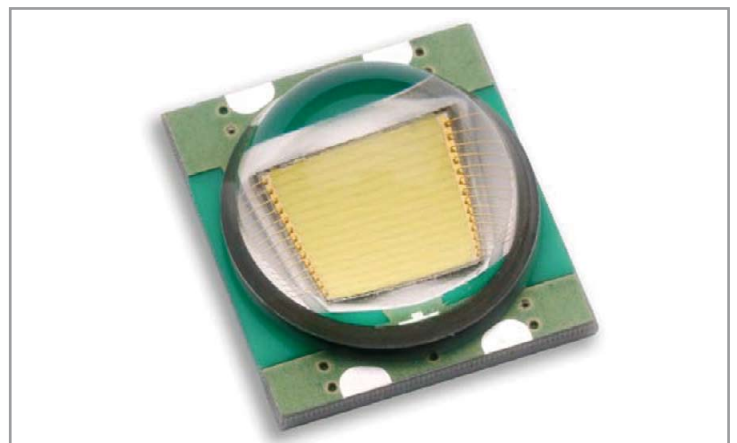

Luminus Devices SST-90 general lighting white LED package

"The SST-90 is a surface mount package in a form factor that OEMs are familiar with and use regularly," said Dave Sciabica, head of the Lighting Business Group at Luminus Devices. "With the introduction of the SST-90, we continue to enable new applications that benefit from a highly efficient, high-brightness single light source."

The light emitting surface of the SST-90 is a single, monolithic die that is nine square millimeters in size. The SST-90 produces 1,000 lumens with 10 watts input (at 6,500K) and 2,250 lumens at its maximum rated drive current. PhlatLight LEDs are mercury-free and highly reliable and have a lifetime of 60,000 hours with lumen maintenance of greater than 70 percent. The SST-90 is ideally suited for general lighting applications, including architectural, retail and residential lighting as well as wide area street and parking lot lighting. ■

## Avago Technologies: Small High-Power LED Emitters

Avago Technologies, a leading supplier of analog interface components for communications, industrial and consumer applications, launched one of the industry's smallest LED emitters for solid-state lighting applications. With dimensions of 5x4x1.85mm, Avago's new compact one watt (1W) ASMT-Jx1x is packaged in a small outline package (SOP) and capable of being driven at 350 mA to provide high flux output performance. Additionally, this compact LED emitter provides a wide viewing angle, has moisture sensitivity level-one (MSL 1) capability, and is very reliable.

This competitively priced 1W LED emitter is ideal for use in lighting applications where space is constrained. Typical applications include portable lighting appliances, street lighting, architectural facade lighting, retail display lighting, backlighting and specialty lighting applications.



Avago's new and small-sized ASMT-Jx1x series 1W power LED light source

### Applications:

- Architectural lighting
- Garden lighting
- Decorative lighting
- Sign backlight
- Safety, exit and emergency sign lightings
- Specialty lighting such as task lighting and reading lights
- Retail display
- Commercial lighting
- Accent or marker lightings, strip or step lightings
- Portable lightings, bicycle head lamp, torch lights.
- Pathway lighting
- Street lighting
- Tunnel lighting

### Features:

- Small package footprint with 165-degree viewing angle
- Available in Red, Amber, Green, Blue, Cool White, Neutral White and Warm White colors
- Electrically isolated heat sink
- Long operating life
- Energy efficient
- Low thermal resistance
- ISO and QS9000 certified
- Moisture sensitivity: MSL 1
- Pb-Free and RoHS compliant

Despite its compact size, the ASMT-Jx1x provides a maximum viewing angle of 165-degree to meet the needs of designers who require good color and light output uniformity in their lighting applications. Avago's ASMT-Jx1x is a high performance LED designed to handle high thermal and high drive currents. By delivering a high flux output of up to 87 lumens (lm) at 350mA, this LED features a maximum allowable junction temperature of 150 degrees-C and high Electrostatic Discharge (ESD) resistance of 16 kV which makes this LED insensitive to ESD. As a result, special ESD protection equipment is not required to handle the part during installation. Moreover, this 1W LED is compatible with standard SMT reflow soldering processes and helps lower design costs while providing lighting designers with more freedom and flexibility in designing their applications. ■

## ON Semiconductor: 6 W LED Driver With Integrated DC-DC Boost Converter

ON Semiconductor, a leading global supplier of high performance, energy efficient, silicon solutions has introduced the CAT4106 - a new six watt (6W) LED driver with an integrated, high-power DC-DC boost converter and on-chip diagnostics to maximize efficiency in larger, general purpose LCD panel backlighting applications.

As the company's first multi-channel boost device, the CAT4106 is capable of driving as many as 40 white LEDs – or four strings of ten LEDs with up to 36 volts (V) per string – for a total of 6W of LED output power. Additionally, the device enables designers to maximize backlighting efficiency and reduce space via its built-in diagnostics functions, which automatically adjust the output voltage to drive the highest forward voltage (Vf) string with the minimum head room voltage.

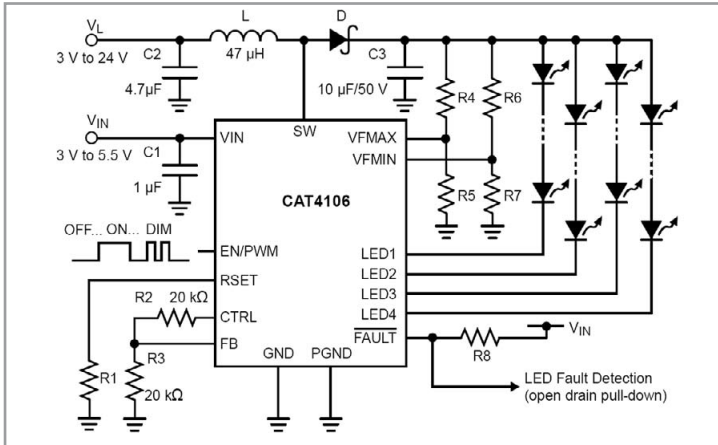

Typical application circuit with CAT4106

The on-chip diagnostic circuit allows designers to set the minimum and maximum voltage limits for the acceptable range of operation for LED strings through external programming resistors. Any channel which does not regulate within the set range of Open Circuit or Short Circuit LED will be detected and flagged on the FAULT logic output (active-low, open-drain). The device also provides thermal shutdown and overvoltage protection (OVP).

#### Features:

- Four matched output LED channels
- Integrated DC-DC boost converter
- Up to 6W LED total output power
- Low dropout LED channels, 500mV at 175mA
- High-frequency PWM interface, up to 2kHz
- On-chip diagnostics with adjustable short/open LED detection

#### Packaging:

- 16-lead TQFN, 4mm x 4mm
- 16-lead TSSOP, 4,4mm, exposed thermal pad

The CAT4106 features low dropout LED channels of 500mV at 175mA and a high-frequency pulse width modulation (PWM) interface, which supports multiple frequencies up to 2kHz, providing precise, high-resolution dimming control while the device remains fully biased. ■

## Green LED-MR16 Bulbs from GlacialLight

LED light manufacturer GlacialLight, a subdivision of the experienced technology manufacturer GlacialTech, Inc. is launching a brand new LED-MR16 light bulb. The new green energy saving LED light is a much more enhanced version of current LED MR16 models available in markets today. The GlacialLight high brightness LED bulb has a dedicated power source which is Energy Star Certified with a power rating of more than 80% energy to light conversion ratio. Rated at 3W @ 12V DC/AC, the luminaries overall power consumption is extremely economical. LED-MR16 light bulbs are the latest trend in LED technology, which is set to replace traditional MR16 halogen bulbs.

#### LED-MR16 Specifications:

The new green light bulbs come in two models, with the 3WW model having a Correlated Color Temperature (CCT) of 3000K, and the 3CW model having a CCT of 6000K. The former displays a LUX of 155 (1m), while the latter is brighter with 227lux (1m). Both display between an angle of 10°/30° and fall under a two-year warranty. The best operating temperatures are between -20°C ~+40°C. The LED lights are rated at 35,000 hrs lifetime and can fit in a standard GX5.3 base socket. The MR16 LED lights can fit most halogen MR16 bulb sockets without the need for a converter or adapter.

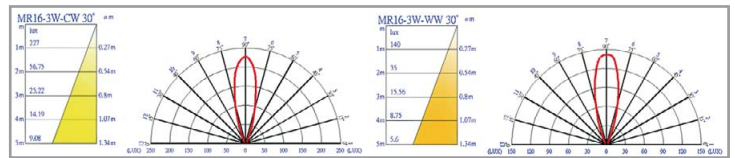

MR16 LED candlepower distribution curve (1m)

As a seasoned Taiwan manufacturer of IT power and heatsink products, GlacialTech management leverages all their expertise, coupling together all the necessary experience to manufacture the best LED lights in the business. The cost effective solutions make GlacialLight stand out as a brand to be reckoned with. GlacialLight has an impressive R&D team with a great deal of experience in power control, thermal management as well as optimal design capabilities. The alignment of such experience brings direct savings to development as well as a reduction in the time taken for development of these economical green LED lighting products. GlacialLight is clearly well positioned to enhance its contribution to the global need to save energy to conserve our planet.

The GlacialLight LED product range offers considerable power savings while extending long product life cycles under normal conditions. The advantages of the LED MR16 bulb are rated at 94% over standard halogen MR16 bulbs in terms of Energy savings. This contribution from GlacialLight to the lowering of the world's carbon footprint cannot be underestimated. ■

## LTM8040: 1A LED Driver & Current Source Protects LEDs

Linear Technology Corporation introduces the LTM8040, the first of a new family of DC/DC uModule™ LED drivers that contains all the circuitry, including the inductor, in a compact 9mm x 15mm x 4.32mm surface mount package. Driving an LED string with the LTM8040 is as simple as adding the input capacitor and connecting the LED string. The LTM8040 can drive from 0A to 1A through a string of LEDs with  $\pm 2\%$  accuracy at full load current. The device protects against an accidental open LED string with its output voltage clamp circuitry and against short-circuit incidents with a frequency foldback scheme. The LTM8040 has applications in 2-cell Li-Ion battery packs, rectified 12VAC and industrial 24V for LCD backlighting, portable lighting, and wide area lighting.

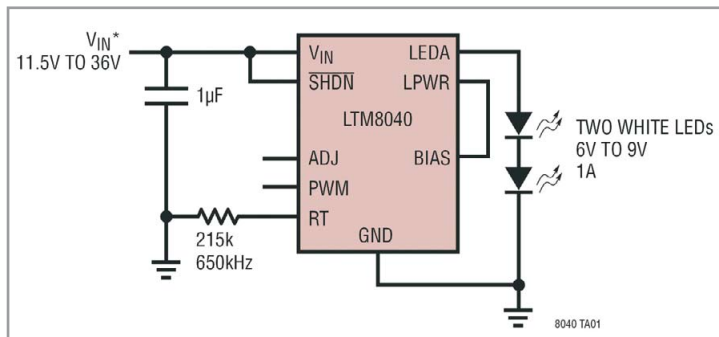

Typical application circuit for LTM8040

### Features:

- True Color PWM delivers constant color with 400:1 dimming
- Wide input range: 4V to 36V
- Up to 1A LED current
- Adjustable control of LED current
- High output current accuracy is maintained over a wide range from 35mA to 1A
- Open LED and short-circuit protection
- Grounded cathode connection
- Small footprint, low profile surface mount LGA package

### Applications:

- Automotive and avionic lighting
- Architectural detail lighting
- Display backlighting
- Constant current sources

The LTM8040 can convert an input voltage range of 4V to 36V to a lower voltage ranging from 2.5V to 13V, suitable for driving a wide variety of color and white LEDs with different voltage-drops (VD). The device also features both analog and True Color PWM™ dimming, allowing a 400:1 constant color dimming range. The LED current amplitude can be linearly controlled from 0A to 1A with a single resistor. The default switching frequency is 500kHz, which can be adjusted with a resistor for up to 2MHz operation.

The LTM8040 is housed in a 9x15x4,32mm land grid array (LGA) package and is offered in two temperature grades of 0°C to 125°C and -40°C to 125°C (internal package temperature). ■

## Driver Family Extension Meets Demands of Next Generation LEDs

The RCD series of constant current LED Drivers from Recom has been extended to a maximum of 1200mA to provide the higher currents needed by the next generation of high brightness LEDs. The RCD-24-1.0 and RCD-24-1.2 DC/DC converters deliver a stable maximum current of 1A or 1.2A respectively from a wide input voltage range of between 5V and 36VDC. The modules measure only 22mm x 12.5 x 8.5mm and yet are fully complete plug-n-play units requiring no external components, thus reducing the circuit footprint compared with alternative discrete solutions by up to 50%.

The RCD series have two independent dimming inputs: a PWM control that allows simple interfacing with microprocessors and digital controllers and an analogue voltage input that is suitable for lighting controllers or rheostat dimmers. Both dimming inputs are linear and the dimming range covers 0%-100%. The PWM input can also be used to shut down the converter to draw only 200µA from the supply.

The sophisticated feedback control circuit used in the RCD family of LED drivers ensures excellent load and current regulation, resulting in LED current stability of  $\pm 1\%$ , a residual output ripple of less than 200mV and efficiencies of up to 96%. The low internal power dissipation of only 800mW permits the ambient operating temperature range of -40°C to +71°C for the 1000mA version and -40°C to +65°C for the 1200mA version. The drivers also feature short circuit protection and thermal shutdown.

The drivers have been designed to be as reliable as the LEDs they are driving and contain no electrolytic or tantalum capacitors. ■

## National Semiconductor: TRIAC Dimmable LED Driver

National Semiconductor Corp. (NYSE:NSM) introduced a new constant-current controller that enables off-line, uniform, flicker-free dimming of high-brightness light-emitting diodes (LEDs) with a conventional TRIode for Alternating Current (TRIAC) forward or reverse phase-control wall dimmer. The LM3445 TRIAC dimmable LED driver enables a full 100:1 range of dimming capability and can maintain greater than 1A of constant current to large strings of LEDs in a variety of residential, architectural, commercial and industrial applications.

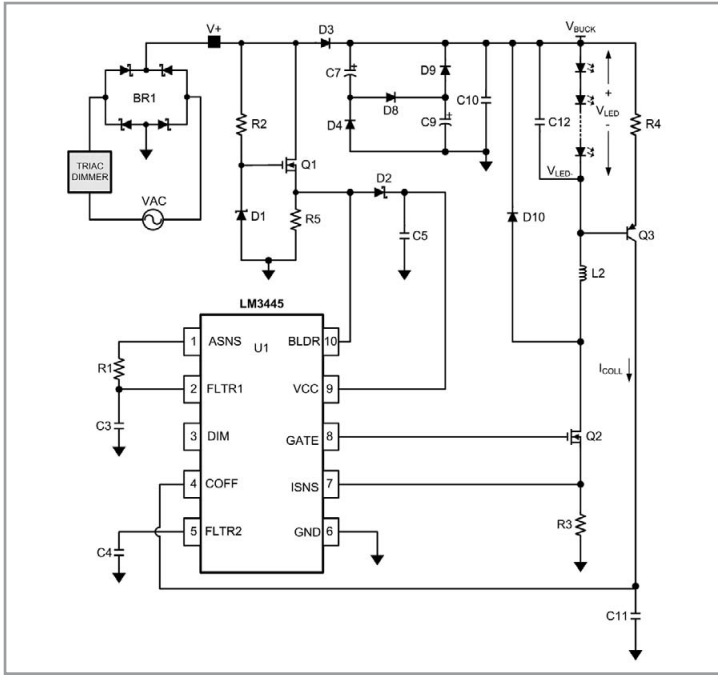

Typical application circuit of the LM3445

The LM3445 TRIAC dimmable LED driver maximizes the light output for systems while maintaining ENERGY STAR® power factor requirements in a typical application, positioning it among National's PowerWise® family of energy-efficient products.

Today's TRIAC wall dimmers are designed to interface with a resistive load such as incandescent or halogen light bulbs. Since an LED bulb does not appear as a resistive load to the TRIAC wall dimmer, dimming an LED bulb using a conventional TRIAC wall dimmer does not yield optimal dimming performance. LED drivers available today cause either a 120Hz flicker of the LEDs or do not enable the full 100:1 dimming range. National's LM3445 overcomes this challenge by translating the TRIAC-chopped waveform to a DIM signal and decoding it for a full-range of uniform, flicker-free dimming. The driver's patent-pending control architecture maintains constant ripple through the LEDs, which extends the life of the LEDs.

National's LM3445 LED driver enables direct LED bulb replacement of existing incandescent or halogen bulb systems connected to standard TRIAC wall dimmers. In addition, the LM3445 allows master-slave operation, enabling the control of multiple strings of LED bulbs.

#### Technical Features:

Offered in a 10-pin mini SOIC package, National's LM3445 is an adaptive constant off-time AC-DC buck (step-down) constant current controller that includes a TRIAC dimming decoder. The decoder allows wide-range LED dimming, using standard TRIAC dimmers. The high-frequency capable architecture allows the use of small external passive components.

The LM3445 includes a bleeder circuit to ensure proper TRIAC operation by allowing current flow while the line voltage is low to enable proper firing of the TRIAC. A passive power factor correction circuit ensures good power factor by drawing current directly from the line for most of the cycle, and provides a constant positive voltage to the buck regulator. Additional features include thermal shutdown, current limit and under-voltage lockout. ■

## NXP: World's First Integrated Dimmable Mains LED Driver IC

NXP Semiconductors, the independent semiconductor company founded by Philips, launched the SSL2101 - the world's first integrated dimmable mains LED driver. The NXP SSL2101 is a small form factor Switched Mode Power Supply (SMPS) controller IC specifically designed to drive LED devices and provide dimming capabilities to further improve the energy efficiency of LED lighting.

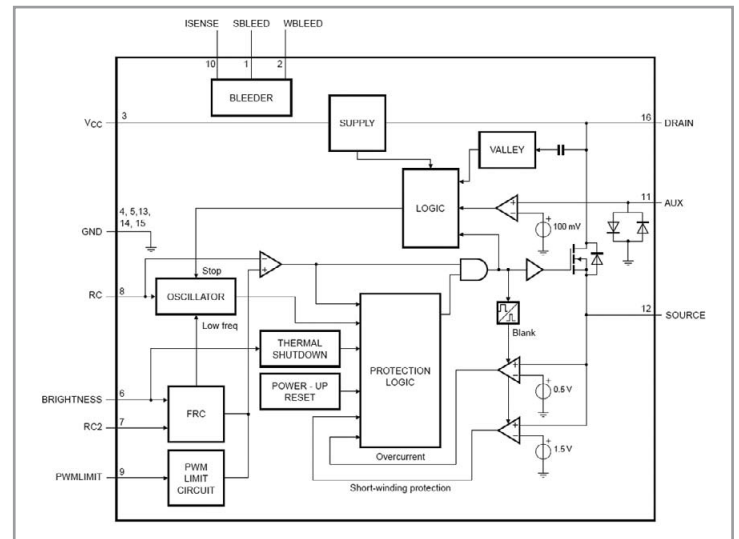

Block diagram of the SSL2101

The dimming capabilities offered by the SSL2101 create unique opportunities for lighting system designers to produce more energy efficient systems. With the high integration level, this cost effective device reduces the number of total electronic components and allows designers to fully reap the benefits of dimmable LEDs while minimizing precious board space.

The SSL2101 is fully compatible with today's lighting infrastructure and can operate directly from rectified mains power supply in combination with a phase cut dimmer. The SSL2101 includes a high-voltage power switch and can start-up directly from the rectified mains voltage, so no external startup circuit is required. To support its dimming capabilities the SSL2101 contains two integrated high voltage-switches for bleeder operation and an input that can be used to sense lamp power usage and activate additional bleeder action when needed.

CREE SETS THE STANDARD FOR ARCHITECTURAL, RESIDENTIAL, COMMERCIAL AND OUTDOOR LIGHTING



**CREE XLAMP® LEDs. THE CHOICE WHEN 4 BILLION PEOPLE ARE WATCHING.  
THAT'S LIGHTING-CLASS.**

Built to deliver energy-efficient beautiful light, Cree XLamp LEDs outperform all others in brightness and efficacy. And they prove it daily at thousands of commercial, architectural and residential installations worldwide.

Contact a Cree Solutions Provider or authorized distributor at [www.cree.com/xlamp](http://www.cree.com/xlamp) or call 800-533-2583.



**XLamp XR-E**  
The proven platform.  
Up to 114 lumens  
at 350 mA



**XLamp MC-E**  
Up to 456 lumens  
at 350 mA —  
4x the flux, same  
size as an XR-E.



**XLamp XP-E**  
Same output as  
the XR-E at 20%  
the package size.



Photos depict actual installations using Cree XLamp LEDs. Cree, the Cree logo and XLamp are registered trademarks of Cree, Inc.

The SSL2101 also offers non-isolated (buck) and isolated (fly-back) solutions in one chip. It has an additional input that can be used to detect demagnetization of the inductive element, ensuring full utilization of the magnetic material and preventing hard switching of the current. The device has in-built circuitry to reduce capacitive switch-on losses and optimize valley switching efficiencies therefore making the SSL2101 an effective power converter at low power levels. The SSL2101 uses on-time mode control and frequency control to control the LED brightness. This combined effect of both frequency variation and on-time control results in a dimming curve similar to that of an incandescent lamp. The usage of both control methods also enables the designer to reduce peak current, helping in the reduction of audible transformer or inductor noise.

The IC offers a reliable and safe thermal solution via a thermal enhanced package with a built-in Over Temperature Protection (OTP). It also features Short-Winding Protection (SWP), Over Current Protection (OCP) and is aligned with regulations on safety and power factor. ■

## CRS Electronics: Record Performance for LED MR16 Replacement Lamps

CRS Electronics, a world leader in Light Emitting Diode (LED) MR16 halogen replacement lamps, has achieved another significant breakthrough in performance.

The company has received confirmation from LTL Testing Laboratory Inc., a US Department of Energy CALiPER qualified facility, that their newest model LED MR16 product achieved a temperature stabilized light output of 325 lumens at a color temperature of 2850K. The light also has a center beam candpower of 1800, a color rendering index (CRI) of 88, and an efficiency of 53 lumens per watt - more than four times the efficiency of many halogen MR16 lamps.

CRS released its first LED MR16 lamp in 2008, replacing existing halogen MR16 lamps and reducing energy consumption by 75%. The first model with continuing demand in applications such as elevators, hallways and restaurant settings, achieved industry leading performance levels for brightness, light quality, and fixture compatibility.

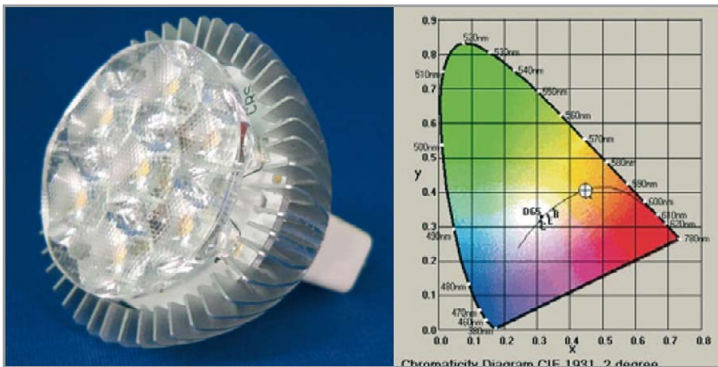

The CRS MR16 replacement lamp that achieved a 325lm@2800K

"These latest test results re-confirm our leadership position in LED MR16 replacement lamps" said Scott Rieseboch, president of CRS Electronics. "According to a US Department of Energy report, LED technology has the potential to significantly reduce electricity consumption worldwide, and the technology is advancing quickly."

"Although they cost significantly more than traditional halogen lamps, the short payback period of about one year combined with a three-year warranty make for a very wise investment," says Brian Moreau, owner of the Blue Star Restaurant in Welland, Ontario.

In 2008, CRS Electronics completed the largest LED residential lighting retrofit in North America. All 44 floors of Toronto's prestigious waterfront Palace Pier condominium tower now feature the company's first model of LED MR16 lamps, with a 150 lumen output and a CRI of 96 as the primary light source for the corridors. ■

## Research News

### Increased Optoelectronic Device Performance

In the past decade, Group III-nitride materials have been widely used for visible and ultraviolet light emitting diodes and blue, violet laser diodes. Most of these optoelectronic devices are typically fabricated on the conventional polar (0001) c-plane oriented substrate materials. Devices grown on the polar substrate orientation suffer undesirable spontaneous and piezoelectric polarization resulting in significant band bending in the quantum well. This reduces radiative recombination efficiency and lowers device performance.

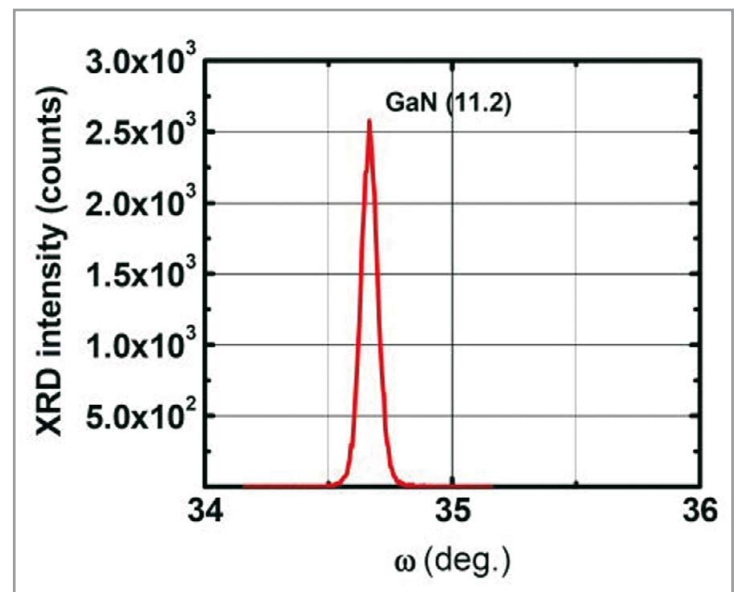

XRD w-scan rocking curve



Now the technical team at Oxford Instruments-TDI, led by Dr. Alexander Usikov, has made significant progress in solving this problem, and is working closely with a leading LED manufacturer to fabricate these semi-polar GaN layer for optoelectronic devices. This would increase radiative recombination efficiency and device performance.

In order to diminish these polarization effects, growth of GaN-related devices along semi-polar and non-polar directions has been studied intensely. Using hydride vapour phase epitaxy (HVPE), the team has grown high quality, semi-polar (11.2) oriented GaN on (10.0) m-plane sapphire with an intermediate layer between the sapphire substrate and the GaN layer.

The semi-polar (11.2) GaN layers were grown in the temperature range from 930°C to 1050°C in an inert argon ambient at atmospheric pressure. Gallium and aluminum were used as metallic source materials and hydrogen chloride (HCl) and ammonia (NH<sub>3</sub>) as the active gases for the HVPE process. The epitaxial growth of GaN was performed at approximately 60µm/per hour using an intermediate layer deposited on m-plane sapphire followed by an undoped GaN layer. The growth procedure results in high quality, semi-polar GaN layer with thickness up to 30mm. ■

## Cooling, a Magnetically Attractive Solution, Maybe for SSL Cooling too

Electricity-guzzling cooling systems could soon be a lot smaller, quieter and more economical thanks to an exotic metal alloy discovered by an international collaboration working at the National Institute of Standards and Technology (NIST)'s Center for Neutron Research (NCNR).\*

The alloy may prove to be a long-sought material that will permit magnetic cooling. The magnetic cooling technique, though used for decades in science and industry, has yet to find application in the home because of technical and environmental hurdles – but the NIST collaboration may have overcome them.

Magnetic cooling relies on materials called magnetocalorics, which heat up when exposed to a powerful magnetic field. After they cool off by radiating this heat away, the magnetic field is removed, and their temperature drops again, this time dramatically. The effect can be used in a classic refrigeration cycle, and scientists have attained temperatures of nearly absolute zero this way. Two factors have kept magnetic cooling out of the consumer market: most magnetocalorics that function at close to room temperature require both the prohibitively expensive rare metal gadolinium and arsenic, a deadly toxin.

The alloy the team has found, a mixture of manganese, iron, phosphorus and germanium, is not merely the first near-room-temperature magnetocaloric to contain neither gadolinium nor arsenic – rendering it both safer and cheaper – but also it has such strong magnetocaloric properties that it could rival gas compression in efficiency.

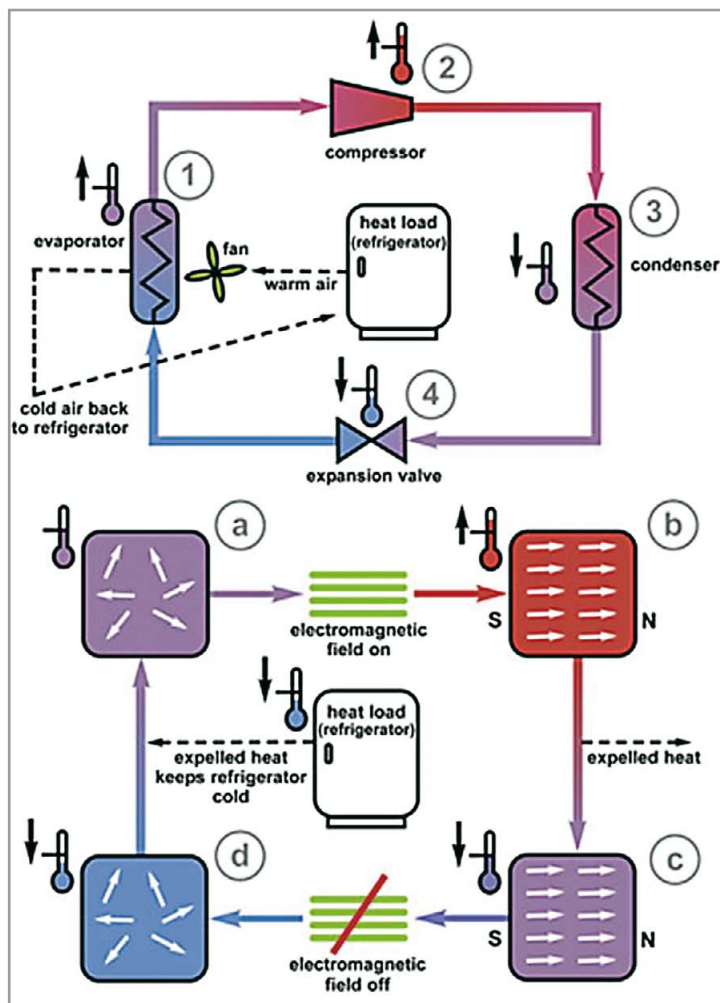

**HOW IT WORKS:** Conventional and magnetic refrigeration cycles use different physical effects to cool things off. [Top] When a gas is compressed (2), it heats up, but if it is cooled and then allowed to expand (3), its temperature drops much lower than it was originally (4); this principle keeps food in your home refrigerator cool. But a magnetocaloric material [bottom] heats up when magnetized (b); if cooled and then demagnetized (c), its temperature drops dramatically (d)

Working alongside (and inspired by) visiting scientists from the Beijing University of Technology, the team used NIST's neutron diffraction equipment to analyze the novel alloy. They found that when exposed to a magnetic field, the newfound material's crystal structure completely changes, which explains its exceptional performance.

"Understanding how to fine-tune this change in crystal structure may allow us to get our alloy's efficiency even higher," says NIST crystallographer Qing Huang. "We are still playing with the composition, and if we can get it to magnetize uniformly, we may be able to further improve the efficiency."

Members of the collaboration include scientists from NIST, Beijing University of Technology, Princeton University and McGill University. Funding for the project was provided by NIST. ■

\* D. Liu, M. Yue, J. Zhang, T.M. McQueen, J.W. Lynn, X. Wang, Y. Chen, J. Li, R.J. Cava, X. Liu, Z. Altounian and Q. Huang. Origin and tuning of the magnetocaloric effect for the magnetic refrigerant MnFe(P1-xGex). *Physical Review B*. Vol. 79, 014435 (2009).

## Project

# LED Makeover, Yielding 90% Energy Saving

> Alexander Mueller, Business Development Manager, Future Lighting Solutions

Walk into Future Electronics' new EMEA headquarters outside of London, and you step into the lighting world of the future. From the custom green LED array gleaming like an emerald racing stripe beneath the reception desk to off-the-shelf LED luminaires installed both inside and outside the building, 'Future House' is filled with a rich array of lighting products emerging from today's solid-state lighting revolution. "Our extensive use of LED fixtures shows that we practice what our Future Lighting Solutions division preaches: LED lighting can be used as functional lighting" said Danny Miller, Managing Director at Future Electronics EMEA. LEDs are also slashing lighting-related energy use in the building by as much as 92% per fixture, advancing energy conservation initiatives.

### Solid-State Showcase

Perched on the busy M25 corridor encircling the London metropolitan area, the 64,000-square-foot boulding is as architecturally striking as the lighting inside. Three five-story cylindrical towers are connected by two glass-enclosed wings stretching from the central tower structure at 30-degree angles. The building in Egham, Surrey, was completed in 2000 and became the European nerve center of the Montreal-based electronic components distributor company in July 2008.

In remodeling the building to suit the company's needs, the executives decided to use solid-state lighting products to create a new lighting ambience and to replace many of the existing halogen and CFL fixtures. The goal was to promote the mission of Future Lighting Solutions by turning the building into a billboard for LUXEON-based lighting applications.

### LED Accents in the Atrium

That message is clearly on display as soon as one enters the four-story atrium that serves as the Future House reception area. Decorative lighting on the ground floor as well as functional and accent lighting visible in the upper-story rooms draw the eye to the latest achievements in solid-state lighting design -all selected and in some cases engineered by Future Lighting Solutions itself.

For starters, the toekick of the massive reception desk shimmers with a 150 mm-high ribbon of 70 green LUXEON I LEDs utilizing a custom light engine developed by Future Lighting Solutions, running the full width and depth of the desk, and producing a reflection that creates a double band of green at floor level. The same color scheme is echoed in LUXEON-powered green spotlights and floor lights that replaced the original white halogen lighting in and around the two nearby glass elevators.

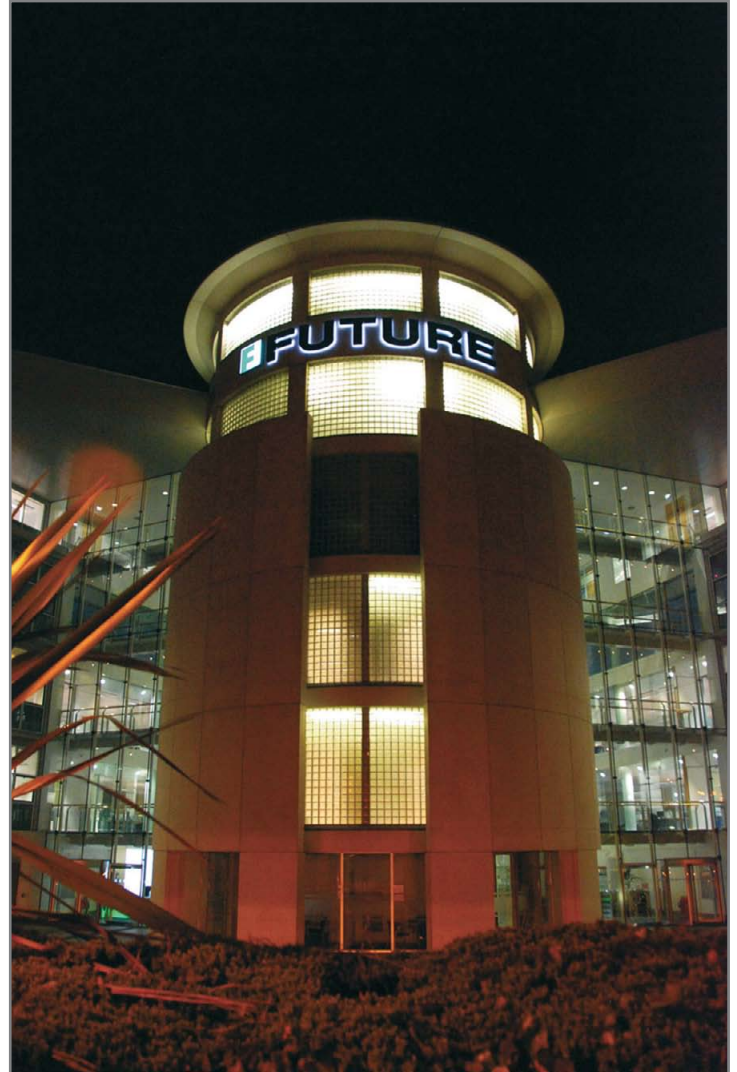

Figure 1: Architectural showcase on the outside, solid-state lighting showcase on the inside



Figure 2: Decorative lighting on the ground floor

Behind the desk, a 5.3-meter-wide x 3-meter-tall world map etched into a frosted Plexiglas panel is backlit by 32 Powerwhite Linear Modules from Dialight Lumidrives, each containing six side-by-side neutral-white LUXEON Rebel LEDs used instead of conventional fluorescent tubes.

Around the perimeter of the atrium, 31 existing 50W halogen MR16 accent lights were retrofitted with 4W Dialight Lumidrives HL16 light engines containing three warm-white LUXEON® K2 LEDs simply by changing the transformer and replacing it with a constant current driver. Each LED retrofit uses only 5W of power when used with a constant current drive compared to 63W for the halogen bulb - typical of the energy savings for each solid-state luminaire in the building.

## All-LED Meeting Rooms

The company went even further in the four executive meeting rooms on the first and second floors, eliminating conventional lighting completely.

In each 14-square-meter meeting room, the four existing twin 26W CFL downlights were replaced with an equal number of LUXEON Rebel-based IST DL090 downlights from Integrated Systems Technologies (IST). The solid-state fixtures provide light output comparable to the CFL versions, fit in the same space, and deliver a performance of 45 lumens per watt that complies with the UK's Part L regulations for fuel and power conservation.

In addition, all eight 50W halogen MR16 lamps installed around the edges of each room were retrofitted with the same three-LED Dialight Lumidrives HL16 light engines as the perimeter fixtures in the atrium. The LED lamps provide the same wall-washing effect and can be used for soft illumination when the downlights are turned off.

The same HL16 light engines were also in the building's two informal ground-floor meeting rooms. The original GU10 halogen fixtures were replaced with an equal number of HL16s, providing the same level of illumination on the meeting tables.

In total, Future Electronics replaced 116 halogen bulbs with warm or neutral-white MR11- or MR16-compatible LED lamps from Dialight Lumidrives, including 42-30W halogen GU10 fixtures in two other meeting rooms near the elevators. The upgrades for those 116 fixtures alone cut energy consumption 92% from 6.974kW to 0.494kW.

## Boardroom & Cafeteria Color

Elsewhere in the building, Future Electronics used LED lighting to create special color effects that add visual interest to some of the main spaces visible from the atrium. In the second-floor boardroom, for example, each of the three drum-shaped fixtures hanging above the conference table is fitted with six warm-white Dialight Lumidrives MR16-compatible light engines for task lighting and topped with 18 blue LUXEON® I LEDs embedded in a custom light engine that bathes the ceiling in blue. Also, the 19 perimeter MR11 fixtures were retrofitted with blue LED lamps to create a blue wash on the walls. Independent switches make it possible to turn on only the blue lights when the room is not in use.



Figure 3: Green LED "racing stripe" and LED-backlit world map greeting visitors at the reception desk



Figure 4: Meeting room entirely lit with solid-state fixtures



Figure 5: The fixture is equipped with warm white LED light engines for task lighting and blue LEDs for ceiling accent lighting

In the first-floor cafeteria, the seating area that overlooks the atrium is appointed with 16 combination white/RGB pendant lights from Italy-based Minulamp that are built with LUXEON Rebel LEDs and hung in clusters of four. The neutral-white LEDs in the bottom of each luminaire supply functional lighting, while the RGB assembly in the top projects constantly shifting color patterns on the ceiling. Whether viewed from the atrium or the seating area itself, the light show - like the blue-lit boardroom - is a conversation piece that is helping to spread the gospel of solid-state lighting.

## A True "Future House"

All told, the initial LED installations yielded a dramatic 86% reduction in lighting-related energy usage, replacing 213 fixtures consuming 12.198kW with an equal number of luminaires plus a few new decorative lighting fixtures drawing just 1.691kW. That includes halogen lamps in the flower beds that were removed in favor of LED landscape lighting from Clarity Lighting, reducing energy usage from 125W to 7W per luminaire.

And there are more savings to come. Over time, the EMEA headquarters plans to add more LED downlights, decorative LEDs on the building's three towers and signage, and other solid-state illumination as new LED products hit the market. ■



Figure 6: Yellow illumination with the white/RGB pendant lights from Italy-based Minulamp

- **brightness control for LED modules of the 24V standard and 24V HighPower series of VS**
- **output current of 5A max.**
- **dimming interface 1-10V or via external PWM**
- **compact design (83x30x19 mm)**
- **especially suitable for integration into luminaires**

## Vossloh-Schwabe's DigiLED Mono CA: A New LED Brightness Control Module

The cost-effective and easy to use dimming control module DigiLED Mono CA from Vossloh-Schwabe is the best-in-class device of its type available on the market to control monochromatic & white LED modules.

The output of 5A enables the dimming of a complete 10m roll of the monochromatic LEDLine Flex SMD modules with only one DigiLED Mono CA. Dimming control via 1-10V input or PWM interface.

**Vossloh-Schwabe:** A New Lighting Experience

[www.vossloh-schwabe.com](http://www.vossloh-schwabe.com)



Sharp LED solutions for bright sparks

# LED's work together!

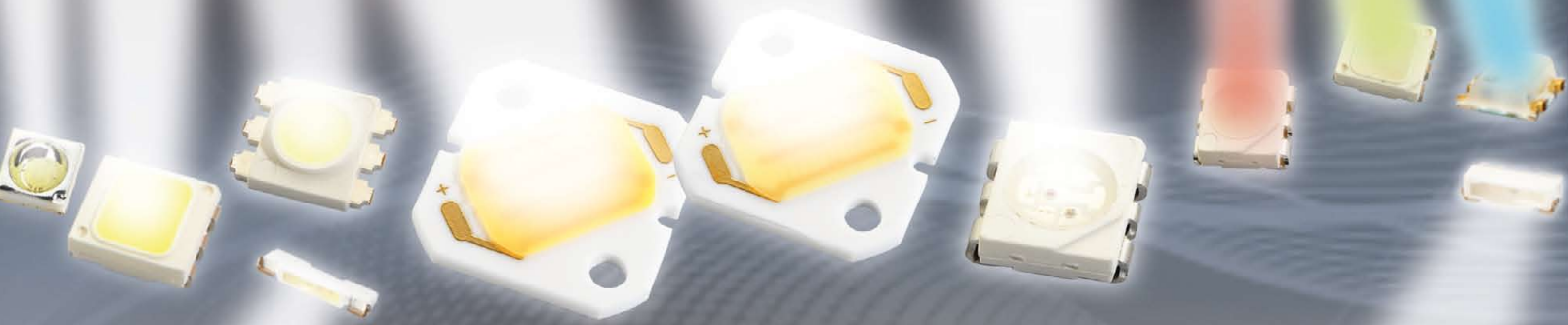

[IC]

[OPTO]

[LED]

[LCD]

[RF]

Go for the broad range of Sharp LED solutions to present your applications in the best possible light: LED multi-chip modules, white light LEDs, RGB LEDs and flashlight LEDs. Whether single spotlight or wide-area ambient lighting, indoor or outdoor, stationary or mobile usage, Sharp LEDs combine maximum efficiency and lifetime with minimal heat generation. You can define white in the most beautiful tones – anything from warm to cold white and high CRI optimised for almost natural colour reproducibility. The Sharp portfolio offers a wide variety of different packages: from PLCC2 to

PLCC6, standard or extra thin, sideshoot and ultra-small – and features LEDs for work and reading lamps, indoor and outdoor lighting, signalling equipment and advertising panels, flashlights and displays as well as architectural and medical applications. Call or mail us to benefit from 37 years of experience in LED technology.

**Our Service Team will be glad to supply you with any engineering samples and advice you need. E-Mail: [info.sme@sharp.eu](mailto:info.sme@sharp.eu) phone: +49 (0)180 507 35 07**

**SHARP**

| Microelectronics

## Application

# ALADIN – An Advanced Lighting System for Improved Health and Wellbeing

> Edith Maier, Walter Ritter, University of Applied Sciences Vorarlberg, AT, and University of Applied Sciences St. Gallen, CH

Like Aladdin in the medieval oriental folk-tale, the assistive lighting system developed by ALADIN (Ambient Lighting Assistance for an Ageing Population), a research project co-financed by the European Commission, is expected to bring enchantment to people's lives. Adaptive lighting can contribute considerably to sound sleep and a regular sleep-wake cycle regulated by people's 'inner clock'. This tends to deteriorate with ageing, but is essential to preserve and enhance comfort and wellbeing. And this is the main goal of the assistive ALADIN lighting system.

So called 'ambient lighting' with varying color, temperature and brightness has been in use for some time. However, the user has no possibility to interact with the predefined control strategy and the lighting solutions do not take into account individual differences (Boyce and Mcibse, 2006).

The intelligent control system of ALADIN, however, is capable of

- capturing and analyzing the individual and situational differences of the psycho-physiological effects of lighting, and
- enabling the users to make adaptations tailored to their specific needs.

## The Impact of Lighting on Health and Wellbeing

Light affects the elderly mainly in terms of sleep quality, changes of mood and cognitive performance as well as the metabolic system. The negative impact of poorly designed or maintained indoor lighting resulting in unbalanced luminance in the field of view, glare, wrong intensities and light colors (spectra), flicker etc. has been documented (Heschong, 2002; Schweitzer et al, 2004; Ulrich, 2001). These intensify existing vision problems, add to eye fatigue and headaches and contribute to a loss of concentration.

The results of studies of nursing-home patients and hospitalized elderly patients suggest that increased daytime light exposure, measured by duration and intensity, has an impact on night-time sleep quality and consolidation (Shochat et al, 2000). There is also an empirical laboratory evidence for the superiority of so-called "dynamic lighting", which provides light outputs varying over time, for visually demanding activity

(Abdou, 1997). As natural lighting is almost always dynamic, there are probably evolutionary mechanisms in humans that make them prefer a certain dynamism of lighting.

Impaired vision is one of the most common problems with advancing age, usually caused by physiological and pathological changes in the eye like cataracts or longsightedness. To compensate for diminished vision, the level of illumination has to be increased up to three times for older people, which makes higher standards in lighting in older people's homes necessary, e.g. through increasing light levels, improving color perception and increasing contrast.

Despite the abundance of studies on the effect of lighting there still remain many questions. Among the lacunae in our knowledge is the amount of light required, the most effective way of administering light, whether there is any adaptation effect as there is in the visual system, the effect of different spectra and the influence of the timing of light exposure (Boyce and Mcibse, 2006).

## Theoretical and Methodological Underpinnings

Getting to know one's target group is essential for the future acceptance and use of any assistive system. To find out what users really need and want, empirical research using mostly qualitative and ethnographic methods such as interviews and observation is called for.

Further cornerstones the approach are the scenarios outlined by the ISTAG Group. The Report has identified different characteristics that contribute to the societal acceptance of ambient intelligence, namely:

- Facilitate human contact
- Be orientated towards community and cultural enhancement
- Help to build knowledge and skills for work, better quality of work, citizenship and consumer choice
- Inspire trust and confidence
- Be consistent with long term sustainability both at personal, societal and environmental levels
- Be controllable by ordinary people

These ideas lie at the core all necessary endeavors. Throughout the project the barriers that may hinder the acceptance of the ambient intelligence approach were taken into account:

- People do not accept everything that is technologically possible and available.
- People need resources/capabilities to buy and use technologies (money, time, skills, attitudes, language, etc.) that are not evenly distributed in society.
- People make use of new technologies in ways that are very different from the uses intended by suppliers.

The empirical study conducted at the outset of the project to define user requirements as well as the feedback obtained in the course of the field trials very much confirm the importance of both the focus on activity support and the contributory factors for user acceptance outlined above.

## Analyzing User Requirements

APOLLIS, an Italian social research organization, carried out 196 face-to-face interviews in the Autonomous Province of Bolzano. The main goal was to describe typical everyday activities of people aged 65+ to model one-room/one-person use scenarios for the ALADIN prototype.

On the whole, people's ability to imagine the benefits of new technologies for independent ageing are rather limited. Typical reactions are that technology is useless or too complicated, that it makes dependent or threatens to reduce social contact. Overall, the following conclusions can be drawn with a view to increasing future acceptance:

- Light devices must correspond to the sensitivity and limited adaptability of the elderly's eyes. Glare effects and fast light changes should be avoided.
- The whole installation must either be a 'camouflaged' supplement to the existing infrastructure or correspond to individual aesthetic preferences.
- Since motivation to use sensors is mainly correlated to safety matters e.g. automatic emergency call devices, safety concerns have to be taken into account.
- As long as there is a high share of computer non-users within the target group, maximum attention is to be paid to the design of the user interface.

## Tests In a Laboratory Setting

A series of laboratory tests were conducted to determine the psycho-physiological target values for both relaxation and mental activation and examine the impact of various light parameters on older adults. Preliminary to the lab tests, the criteria for the test population were defined. The elderly person should live on his or her own, spend most of his or her time in the apartment or house and regularly watch TV, read newspapers, or perform some pastime activities in a particular room. The daylight situation in this room should possibly be such that the person normally needs artificial light for a specific period of time to perform daily routines. On the one hand, the test persons should be mentally fit enough to make active use of the ALADIN system, on the other hand they should suffer from certain constraints such as limited mobility that prevent them from engaging in frequent outdoor activity in full sunlight. As was to be expected, recruiting suitable test persons was quite challenging.

### Investigating the impact of different light parameters

The Bartenbach Light Laboratory, located near Innsbruck, Austria, carried out tests for defining the psycho-physiological effects of various light parameters such as light intensity and color temperature and tried to establish correlations between light parameters as independent variables and physiological biosignals (blood pressure, heart rate, respiration rate, skin conductance and muscle tension), cognitive performance and subjective perception rated by questionnaires. The tests pursued two objectives:

- Investigate the effects of different lighting situations on older adults in terms of psycho-physiological impact, subjective perceptions and performance.
- Produce recommendations for the prototype lighting system to be installed for the field tests.

Overall, the different lighting situations showed a clear impact on older adults both in terms of activation and relaxation. The effects of lighting could be shown in:

- the test persons' subjective assessments as reflected in the questionnaires,
- the performance tests which measured the test persons' ability to concentrate, and
- the heart rate variability analyses.

Bright light produced the most significant effects in the performance tests. The relaxing effects of all the dim light situations could be shown in the heart rate variability (HRV) analyses, especially in the very low, high and middle heart rate frequencies.



Figure 1: Testing environment at the "Bartenbach Lichtlabor"

These results suggest that bright light of at least 500cd/m<sup>2</sup> and 6500Kelvin is needed to achieve activation in older test persons. In practical terms this means that the lighting system should aim at providing a color temperature between 3000 and 8000 Kelvin and a brightness level of max. 750cd/m<sup>2</sup>. The adaptive lighting system therefore has to be dimmable in the range from 0 to 750cd/m<sup>2</sup>.

### Defining psycho-physiological target values

The Ergonomics Department of the Budapest University of Technology and Economics, was responsible for defining the optimal psycho-physiological target values for the successful accomplishment of mentally or visually demanding (VDT) every-day activities. Target values in electrophysiological measurements are the values which represent the desired state of alertness or relaxation. The intention was to operationalize the mental and physical fitness in terms of alertness or relaxation by measurable indicators.

Skin conductance response (SCR) turned out to be the most appropriate psycho-physiological target value for the envisaged automatic lighting adaptation, i.e. the intelligent control loop. This parameter proved to be the most sensitive for different activities since a very clear and practically important relationship with activation and relaxation levels was found. Besides, this relationship does not only have statistical significance but shows very high absolute differences in pair-wise comparisons. As a further useful benefit, skin conductance response shows no habituation effect. Heart rate emerged as the second best psycho-physiological target value. All the other psycho-physiological parameters did not prove to be sensitive and/or specific enough due to very high individual differences.

## User Testing

In line with the participatory and iterative development approach end-user testing takes place continuously. Given the specific target group the user interface has to conform not only to general usability guidelines, e.g. ISO 924, but also to accessibility guidelines. Hence designed a simple user interface in line with the widely accepted accessibility guidelines of WCAG 2.0. was designed.

In the course of user requirements analysis it emerged that a TV set could be found in almost all households of older adults and that therefore it could be assumed that all target users would be familiar with handling remote controls. Given the more or less universal presence of TV in the home environment, the adaptive lighting system was implemented on a computer with added TV functionality.

The interactive TV user interface of the ALADIN prototype was tested with clients of a care facility for the elderly. Users liked the overall graphic design (font, colors and contrast) and found the GUI easy to navigate, provided that the number of navigation elements was kept to a minimum. Several general observations could be derived from the early user tests:

- The majority of users prefer number keys to cursor keys.
- Users expect immediate confirmation or feedback from the system.
- The number of menu items to choose from should not exceed 5 or 6 items.
- (Semi-)technical terms (e.g. biofeedback) have to be replaced with simple everyday terms (e.g. relaxation exercise).

A special biosensor glove was developed which entailed a change of methodology:

Instead of measuring SCR a photoplethysmography (PPG) to measure peripheral pulse was employed.

The usability test results from the field trials show that the iterative testing approach has paid off. The criticisms voiced by the test persons concern mainly the hardware devices. These components have not been subjected to the same rigorous testing with end-users. The partners responsible for developing the hardware are currently analyzing the results with a view to improving the various components.

## The Modern Version of the Enchanted Lamp

Both the results of the lab tests and the test runs with end-users fed into the development of the ALADIN prototype. It constitutes an intelligent open-loop control and biofeedback system which can adapt various light parameters such as intensity and color in response to the psycho-physiological data. These are continuously registered by the system. It can be manually adjusted via the graphical interface and allows the resetting of all light parameters to their default values. As shown in Figure 2, it comprises the following components:

- Television (Fernsehen),
- Automatic lighting (Automatisches Licht),
- Manual lighting (Manuelles Licht),
- Exercises (Übungen),
- History (Rückschau), and
- Advice & support (Wohlfühl Tipps).

The user can select between these options by pressing the number buttons 1 to 6 or move the cursor to the desired option and press OK on the remote control.



Figure 2: Main menu of ALADIN system

Both hardware, i.e. the sensor gloves and lighting devices, and software applications have been developed to allow easy integration into building management systems and become part of a general assistive environment.

### Technical architecture – overview

The general idea of ALADIN technology is to make as few modifications as possible within the private households of elderly people. This means that preferably already existing, common devices in private households shall be used, to replace these devices with new technologies with additional functionality or to introduce only non-intrusive components for some novel features of ALADIN. An important requirement of the project is that it should be possible to integrate the ALADIN lighting



system into conventional building control systems. There are basically two ways of ensuring that all components of a building system work together smoothly and do not interfere with each other:

- running all components across a single system, or
- installing a special system for every individual service to achieve maximum functional efficiency in each area.

For the research the second possibility was chosen and the LITENET system from Zumtobel Lighting GmbH was used to control lighting devices. It provides interfaces to other building services and higher-level building management systems. Thus seamless system integration between field buses and computer applications such as the ALADIN software can be achieved.

The biosignal recorder used for the prototype is a wireless adaptation of the Varioport device from Becker Meditec to measure electrocardiographic, electrodermal, respiratory and body movement indicators and continuously transfers them to the computer system via bluetooth connection.

Adaptive algorithms for feature detection, optimization, and learning are active continuously as there is no optimal lighting condition; this depends on a person's individual psychological state at a particular point of time. For the field trials the light devices were set at 20% of their maximum when using the genetic algorithm. During the phase with the simulated annealing algorithm the lighting condition at the outset was set randomly. The intelligent control loop is started manually by TV remote control and stopped automatically by a specific motion pattern detected by the intelligent unit or by the user.

#### Hardware components

To ensure the accessibility of the ALADIN user interface a remote control with large keys as well as a tactile and non-slip casing that makes it easier to use for older people is recommended. The ALADIN prototype was programmed for the Meliconi gum body remote control. In the future, this might be replaced by the one-button device currently being developed by Bernhaupt and colleagues in Salzburg (Bernhaupt et al, 2007).

The user navigates the television device as well as the ALADIN software user interface via the remote control. Therefore an infrared control system has to be installed which is able to receive infrared signals from the remote control and send infrared signals to the television device. For ALADIN, an infrared control system was directly connected with the ALADIN software via USB.

The choice of a specific computer device for ALADIN is closely related to the general idea of ambient technology, i.e. implementing computer systems in such a way that the users are hardly aware of them. The Apple Mac Mini computer is small and stylish and can be taken as a common set-top box for television devices. For the benefit of the administrator the computer can be connected with a keyboard and mouse. The user, however, interacts with the ALADIN software only by means of the remote control.

#### Sensor device

As mentioned before, the biosignal recorder used for the prototype is a wireless adaptation of the Varioport device from Becker Meditec. The final biosensor glove was adapted with photoplethysmography (PPG) to measure the peripheral pulse on the index finger, and electrodermal electrodes to measure skin conductance between index the finger and the thumb. The user slips the glove on every time he or she wants to use automatic lighting or perform a biofeedback exercise. The smart biosensor glove can be turned on and off by a small power button. The glove has a rechargeable battery inside which has to be reloaded after twelve hours of operation.



Figure 3: The final biosensor glove

A great deal of research is currently conducted to develop unobtrusive and truly non-invasive sensor devices.

#### Light installation

ALADIN was combined with lighting and control devices from Luxmate, a company that belongs to the Zumtobel Group. The ALADIN system also works with control units of other producers such as Tridonic or Osram. The general lighting control protocol is DALI (digital addressable lighting interface), an open standard in accordance with the International Electrotechnical Commission IEC 60929 standard for fluorescent lamp ballasts.

The ALADIN prototype consisted of least twelve devices. The control circuits are divided in ten lighting channels with five channels for blue colored light (e.g. 8000 Kelvin) and five channels for red colored light (e.g. 2700 Kelvin). A single lighting device is composed of a red and blue colored light. Furthermore the ALADIN prototype also includes a light sensor measuring the light intensity within the room and at least one manual lighting switch to turn on and off the lighting in the usual way.

The ALADIN lighting system consists of two different components (Figure 4):

- a direct or indirect suspended down-light, and
- a ceiling floodlight,

both of which can change spectrum, color temperature, light intensity and directions.

For adaptive lighting, all circuits can use the maximum light variation with all parameters (0-100 %) and in any combination except the two circuits for the direct lighting (table light). A single circuit for direct light has a maximum of 80 % and both circuits together have a maximum of 120 %. To obtain a smooth change, light variation must not exceed 10% per second. Indirect lights are mounted along the whole length of all four sides of the room. The direct light, i.e. the table lamp, produces a great deal of heat, which is why a fan has been added. A bus box contains all the interfaces that are usually included in the building automation system. The light sensor is attached to the table light and normally directed to a window to check the amount of daylight.



Figure 4: ALADIN light installation

### Software architecture

It is essential that the software architecture of ALADIN be open to allow easy integration with other information and communication systems in buildings, thus becoming part of a general assistive environment. For this reason ALADIN is a platform-independent system which can run on any supported operating system platform.

ALADIN has a client-server computing architecture, where the applications are clients who may initiate a communication session (see Figure 2). Each of these applications has a user interface and an application area. Data between client and server are exchanged via TCP/IP.

The applications have been implemented in Java. However, given the above-described approach it would be possible to implement other individual applications using different programming languages if Java should prove inappropriate for any particular application. Client and server communicate via a specially developed ALADIN protocol at the application level. This means that the client application can instruct the server application to start or terminate recording, to store the results or retrieve records already stored.

Each application can store data (e.g. biosignal results) in the persistence layer. All data are saved as plain text into a directory, the name of which records time and date. What is difficult with this type of implementation is the performance of complex queries combining different search parameters. If this should be required in the future, it can be realized due to the abstraction of storage mechanisms provided by the persistence level which allows easy integration of a database.

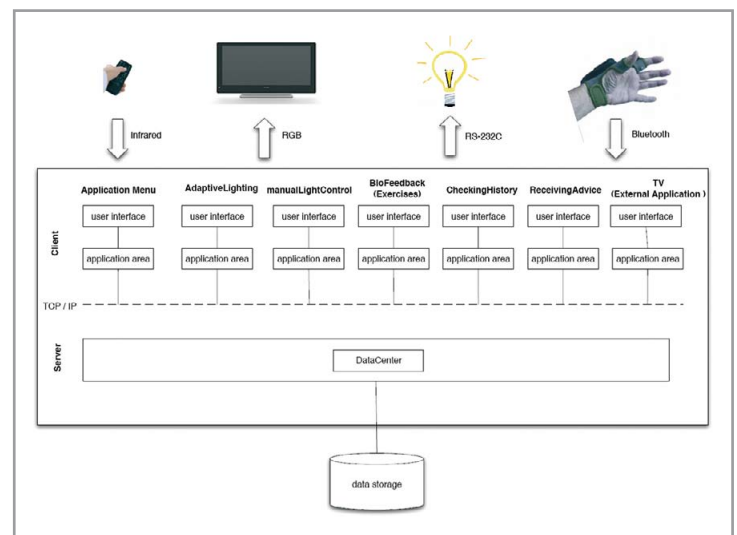

Figure 5: Software architecture of ALADIN

### ALADIN applications

For automatic light adaptation the user has to select either an activating or a relaxing light situation. According to the user's selection the adaptive algorithm (e.g. simulated annealing or genetic algorithm) starts looking for the best individual lighting condition. Before starting the light adaptation the light sensor checks the amount of daylight within the room. The user receives the information to darken the room if it is too bright for adaptive lighting. The automatic light adaptation is achieved by an open loop circuit modifying the light parameters through the DALI interface and interpreting the biosignals (electrodermal activity and heart rate) measured by the biosensor glove as an individual reaction to these light modifications. The result of this interpretation is used by the adaptive algorithms to find the next best light modification. The intelligent control loop is started manually by TV remote control and stopped manually by the user or automatically when the user leaves the room.

After selecting the manual light option in the main menu, the user is offered different options of light situations on the television screen. The user can select one of these options. There are several predefined

lighting situations and one variable light situation where the user can modify the light intensity. ALADIN consists of an administrator tool to define the light situations which are shown on the television screen and/or are available through manual switches, e.g. romantic dinner light, bright light for visually demanding tasks or whatever.

The exercise application of ALADIN contains a set of different relaxing and activating exercises. After starting this application the user gets the information about the number of exercises on a particular day. Relaxation is achieved through continuous biofeedback from the user's own electrodermal activity or the heart rate. Activation exercises include calculating, text searching, memorizing, and a visual guessing task. The user can select one of these exercises as often as he/she wants to relax or to activate. All the parameters of these exercises can be configured by a configuration file of ALADIN system. After finishing an exercise the user receives immediate feedback on his or her success, i.e. the degree of activation or relaxation achieved. The data are stored in the data center of ALADIN.

The history view application of ALADIN shows the individual's success in relaxing and activating in the exercises of the past five days. The data base is composed of the results of the exercises which are automatically analyzed every day at noon by the ALADIN system in a two step process. The results are stored in the data center of ALADIN. The history view application takes this information from the data center every time when the user selects this option and shows the results of this routine on the television screen.

The advice application takes several recommendations from a set of approximately 250 recommendations depending on the outcome of the results from the exercises executed during the last five days. There are six possible results: too much activation during the morning, too much activation during the afternoon, too much activation during the evening, not enough activation during the morning, not enough activation during the afternoon, and not enough activation during the evening.

*Light adaptation algorithms*

With ten individually controlled light circuits, each of which can be set to values between 0 and 255, the number of different possible lighting situations is enormous and therefore it would be impractical to test every single one of them for their effects. One approach consists in implementing uniform search strategies that can find optimal lighting situations by selectively generating new lighting situations and testing them against previously defined target values. ALADIN contains two different algorithms, simulated annealing algorithm (A1) and genetic algorithm (A2). In the field trials the algorithms were tested consecutively for three weeks each.

Simulated annealing is a combination of a so-called hill-climbing search algorithm with a random walk within a state space. The hill-climbing algorithm is simply a loop that continually searches a state with a higher value within a state space containing only immediate neighbors. Because hill climbing algorithms can get stuck on a local maximum they

are combined with a random walk within the immediate neighborhood of the state space. By means of this guided technique a searching path is built based on successive local searching steps from the initial to the best lighting situation.

Each step of the simulated annealing algorithm replaces the current solution by a random "nearby" solution, chosen with a probability that depends on the difference between the corresponding function values and on a global parameter T (called "temperature") that is gradually decreased during the process.

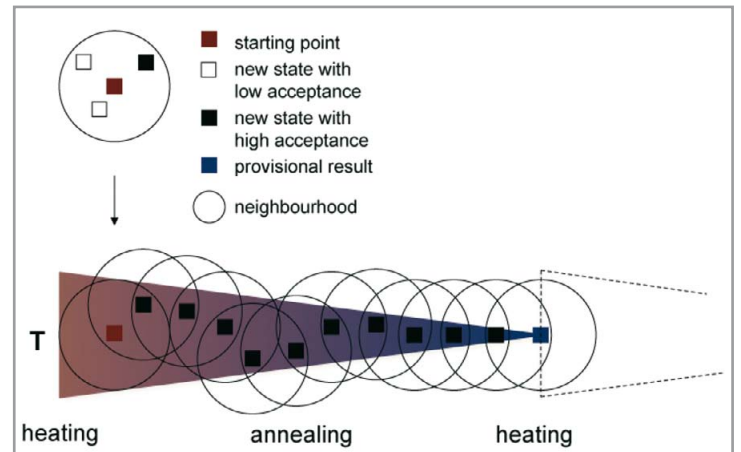

Figure 6: Simulated annealing algorithm

The other approach used is a so-called genetic algorithm which resembles evolution in nature. A genetic algorithm is a stochastic search in which successor states are generated by combining two parent states. This algorithm begins with a set of randomly generated states, called the population. Within one generation each state of the population is rated by the evaluation or fitness function. According to this fitness function two states are selected for reproducing new states applying crossover and mutation procedures. In ALADIN a set of different light scenes determined by the individual brightness levels of the lighting devices forms an initial population.

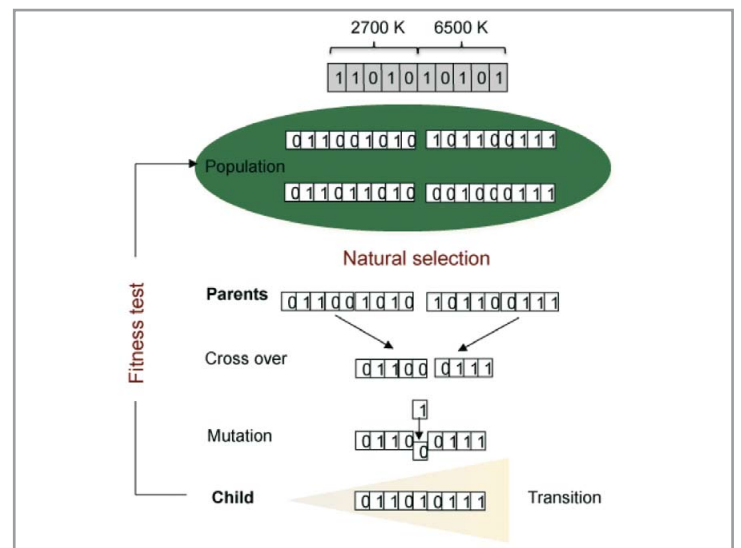

Figure 7: Genetic algorithm

Highly rated scenes become the "parents" and are eventually recombined to form new light scenes. Random mutation can also take place, just like in nature. Once the creation of the new population is finished, the whole process is repeated over and over again. During the course of this process, the generated light scenes should increasingly approximate the desired effect.

Both search algorithms are implemented with different time parameters. The simulated annealing algorithm works with a fixed light transition time of five seconds. Then the lighting parameters are held constant and the psychophysiological effects are analyzed until a trend is found within the biosignal. The maximum time window is two minutes. After two minutes a random change parameterization occurs within 20 seconds. The genetic algorithm introduces a new light situation within a dynamic transition time window. The length of the time window depends on the difference between start and end point of lighting situation. Only ten percent per second modifications are allowed. Analyzing psychophysiological effects is done within a 20 second time window.

Light variation occurs in a very smooth and gradual way from the beginning to the end of transition time. The analyzing window should not be less than 20 seconds to equalize artifacts.

## Discussion of Field Test Results and Outlook

### Findings from field trials

The prototype has been tested in twelve single households for a period of three months. At regular intervals, various mental and physical performance tests as well as life and sleep quality questionnaires were administered. Besides, test persons were encouraged to enter anything they considered worth mentioning and which might affect the outcome of the measurements into personal diaries. During two focus group meetings with the test persons any issues that might not have been included in the questionnaires or log data were discussed. Besides, based on the diaries as well as on information obtained by the coaches that accompanied the test persons during the field trials, case histories have been prepared. These illustrate and convey people's experience with the prototype in a much more accessible way than a list of log data. Case histories can supplement the scientific discussion of the results and are useful for disseminating the results to a wider audience.

The results indicate an overall increase in both mental and physical fitness. On the whole, test persons enjoyed the exercises and found the system easy to handle. However, they would like to have a bigger choice both with regard to the exercises and the music tunes that accompany the biofeedback sessions. Minor improvements in terms of technology acceptance can also be discerned. On the whole, the test persons who evaluated the system in winter and early spring showed a more positive attitude than those using the system in the summer months. This is not surprising since most test persons were active and preferred going for walks outside to watching TV with ALADIN.

People who might benefit most, e.g. the fragile, home-bound older elderly, were represented rather poorly in the test population. To reach the older elderly, different recruitment strategies would have to be employed such as addressing nursing homes or other care facilities/organisations. However, this was ruled out by the focus of the AAL programme on independent living. On the other hand, one may argue that older people should familiarize themselves with new technologies that will help them prolong the period they can remain living at home whilst still in comparatively good health and mobile.

### Outlook on ALADIN's future

The Consortium partners have started looking at opportunities of exploiting the system and its components. The challenge consists in turning research findings into a cost-effective solution that can be marketed successfully to older people across Europe. Anyone who wishes to enhance his or her wellbeing and improve their quality of life by means of intelligent adaptive lighting is a potential customer.

Europe's population is ageing rapidly. ICT and assistive technologies can help deal with the challenges and opportunities presented by this demographic change. It can be assumed that the target group will grow to 135 millions of European elderly aged 65+ by the year 2050.

Given the fact, that the average income of the elderly is expected to increase, a host of economic opportunities with great business potential are opening up for age-related products and services, especially in the healthcare field, but also in the housing and building markets. Because the ALADIN system is modular and therefore flexible, it can be implemented in all housing categories.

So far, intelligent or smart homes have been focusing on building, household appliances and multimedia and the associated technological data processing. The integration of human beings by using the occupants' data - physiological indicators, life style parameters, movement and location, etc. - to assist in their comfort, health and safety has not really been taken into consideration. However, integrating them in future AAL applications would contribute to tailor them to the specific needs, requirements and wishes of particular users.

Another strategy consists in marketing the ambient lighting solution with a voucher for a certain number of hours for technological assistance. Actually, the provision of technical support has emerged as a major prerequisite for user acceptance of new technologies. Most people would be quite happy to pay a higher price provided they are guaranteed a reliable and regular support service, if possible delivered by someone from their own neighborhood or community. Since the elderly tend to suffer from chronic conditions to a disproportionate extent, the evaluation results of self-management programs could be very valuable (Jordan and Osborne, 2007; Kennedy et al, 2004).

Due to mobility constraints, many older people spend a large proportion of their time indoors, which makes optimizing lighting so essential for their wellbeing. When installing lighting systems in the homes of the elderly, quantity, spectrum, timing, duration and spatial distribution are

important characteristics to be considered. In addition, special age-related impairments have to be taken into account. Therefore the basic ALADIN system will have to be supplemented with some extra functions such as automatic daylight supplement to smoothen contrasts between light and shade or automatic corridor illumination by motion sensors.

In the empirical research for ALADIN, the risk of falling down emerged as one of the most common worries among the elderly. The use of lighting for navigational purposes therefore would clearly respond to older people's needs. Although the lighting industry can already offer a variety of solutions that address safety and security concerns such as recessed LED luminaires along staircases or corridors, few people are aware of their existence.

## Conclusions

In all future developments that build on the ALADIN project the USP (unique selling point) must be emphasized, which is user- and situation-specific personalisation and customisation. This is one of the outstanding features that distinguish this solution from the other lighting offerings available on the market. So called 'ambient lighting' with varying colour and brightness has been used and on offer for several years from various lighting companies. On the whole, the user has no possibility to interact with the predefined control strategy (mostly defined by the time of the day or the function of the room) and the lighting solutions do not take into account individual and situation-specific differences. ALADIN, however, can be tailored to the individuals and their environment by capturing sleep and activity/movement patterns as well as psychophysiological parameters such as skin conductance or heart rate.

From the perspective of a future roll-out of the ALADIN system and having in mind the preventive rather than therapeutic intention, it could be an advantageous strategy to conceive ALADIN as a convenient ambient assistance device addressed to technically open-minded younger end users. In the long run, however, the very elderly (75+) will constitute an equally interesting target group, provided the ALADIN functions related specifically to age-related impairments such as

deteriorating sleep quality are emphasized. In this case, it would be important to target the intermediaries, i.e. family members, formal and informal care-givers, when marketing the system.

The price of the system is still a major barrier to marketing the system on a large scale. Even if with bringing the price down due to economies of scale, the price would still be beyond the means of most older people. This is why care facilities and senior residences for the elderly have to be concerned as a potential target group. This, however, would require a certain measure of adaptation since at the moment ALADIN is designed for single rooms in private households.

The modular and open architecture of the ambient lighting solution make it easy to integrate it in building management systems and general assistive environments. Therefore it can be marketed both as a stand-alone product as well as an add-on or option for existing systems.

For the time being, ALADIN is directed at older adults and piloted only in the private homes. However, its findings are relevant for many other target groups as well as other application areas which others might want to explore further:

- Shift-workers (e.g. in industry, in servicing sectors, hospital staff)
- Assistive lighting systems for navigational support for older adults or people with cognitive impairments.
- Air-traffic controllers or any other personnel responsible for the safety and security of critical installations such as nuclear power plants or chemical factories.
- Office workers, in general, should benefit in terms of significant increases in work productivity.
- Automotive Industry Applications, like the interior lighting of cars, applying ambient illuminating systems to facilitate the handling of single functions, to reduce fatigue of the driver and to increase safety.

Because the system consists of modular components it can be adapted to different contexts such as hospitals, airplanes, vehicles, health centers and offices, and be extended to other contextual variables such as temperature, acoustics or displays. ■

## References:

- Abdou O (1997) Effects of Luminous Environment on Worker Productivity in Building Spaces. *Journal of Architectural Engineering* 3:124
- Bernhaupt R, Obrist M, Weiss A, Beck E, Tscheligi M (2007) Trends in the Living Room and Beyond. *Lecture Notes in Computer Science* 4471:146
- Boyce P, McBise F (2006) Education: the key to the future of lighting practice: The Trotter-Paterson memorial lecture presented to the Society of Light and Lighting, London, 21 February 2006. *Lighting Research & Technology* 38(4):283
- De Ruyter B (2003) 365 Days of Ambient Intelligence Research in HomeLab
- Friedewald M, Da Costa O (2003) Science and Technology Roadmapping: Ambient Intelligence in Everyday Life (Aml@ Life). Karlsruhe: Fraunhofer-Institut für System- und Innovationsforschung (FhG-ISI)
- Harland C, Clark T, Prance R (2002) Electric potential probes—new directions in the remote sensing of the human body. *Measurement Science and Technology* 13(2): 163-9
- Heschong L (2002) Daylighting and human performance. *ASHRAE Journal* 44(6):65-67
- ISTAG (2002) Report of working group 60 of the 1st advisory group concerning strategic orientations and priorities for ist in fp6. Tech. rep., Bruxelles
- Jordan J, Osborne R (2007) Chronic disease self-management education programs: challenges ahead. *Medical Journal of Australia* 186(2):84
- Kennedy A, Gately C, Rogers A, EPPE (2004) National Evaluation of Expert Patients Programme: Assessing the process of embedding EPP in the NHS: Preliminary survey of PCT pilot sites
- Mayring P (1987) Subjective well-being in the aged. Status of research and theoretical development. *Z Gerontol* 20(6): 367-76
- Nakashima H (2007) Cyber Assist Project for Ambient Intelligence. *Frontiers in Artificial Intelligence and Applications* 164:1-20
- Pollack M (2005) Intelligent Technology for an Aging Population. *AI Magazine* 26(2):9-24
- Schweitzer M, Gilpin L, Frampton S (2004) Healing Spaces: Elements of Environmental Design That Make an Impact on Health. *Journal of Alternative & Complementary Medicine* 10(Supplement 1):71-83
- Shochat T, Martin J, Marler M, Ancoli-Israel S (2000) Illumination levels in nursing home patients: effects on sleep and activity rhythms. *Journal of Sleep Research* 9(4):373-379
- Ulrich R (2001) Effects of healthcare environmental design on medical outcomes. *Design and Health: Proceedings of the Second International Conference on Health and Design Stockholm, Sweden: Svensk Byggtjänst pp 49-59*

# A New White Light Solution Using an End-User Design Approach

> Gary Trott, VP Business Development, Cree LED Lighting

Each day, around the world, people leave their homes for work, school and appointments, or perhaps to run errands. And each day, these people work, learn, sit and shop under many different lighting systems. But how many people can say that those lighting systems were designed specifically for them? How many commercial lighting solutions have been designed with the activity and comfort of the end user in mind?

By focusing on the end user and building an ideal solution for a specific audience or application, a company may be able to overcome challenges, break new ground and create a more effective product with immediate commercial appeal.

## Beginning at the End (User)

In order to design the most efficient, effective and occupant-friendly lighting system, the design process must begin at the end. To solve a problem, one needs to better understand the application. When Cree, a U.S.-based LED lighting company, began work on a new commercial LED lighting solution, the company embraced an end user design approach. For the development of the new LR24, an architectural lay-in designed for applications that require high ambient light levels, the design process began with the end user in mind.

First, the specific audience for the luminary was defined, with a focus on applications requiring high ambient lighting – applications where lighting significantly affects the environment. Offices, schools, hospitals, retail – these environments were the central design focus.

With the target audience and applications defined, the next step is to determine the specific lighting usage for these applications. How and where will the environments use lighting? How much light will they need and how should it be distributed? Visual comfort of the end users, which is often overlooked or disregarded, should also be considered. The end users of the targeted applications – teachers and students, doctors and patients, office and store workers – are typically exposed to the same lighting for long periods of time, creating a need for warm, soft, but well-lit white light environments.

Finally, it is important to take into consideration the desired architectural look of luminaries that designers crave in today's buildings. Designers want streamlined, contemporary designs that can blend seamlessly with any architecture. They want luminaries with superior form and function that subtly enhance a room.



Figure 1: Cree's LR24 Luminary

## Analyzing Existing Solutions

Once product development teams identify a specific audience and use for a new product, it becomes much easier to identify attributes of the product to improve. Each product component, design element or performance output is measured against the most ideal solution for the end user. Asking, for example, "Will this design element produce the most optimal lighting solution for the end user?" Ultimately, this practice helps break from standard practices in product design. Instead of simply accepting the industry norm, companies should challenge themselves to create a better solution for the target end user.

For the LR24, this meant analyzing existing fluorescent and LED solutions. For commercial applications, various fluorescent and LED options exist, each with different design considerations and issues. Linear fluorescents have long dominated the commercial lighting market due to their energy efficiency and relatively low cost; however, these benefits often come at the expense of compromised aesthetics and luminary efficiency. The linear fluorescent tube, while standard among commercial fluorescent lighting solutions, inherently limits the system design possibilities. In addition, efficiency is limited because half of the light is going in the wrong direction. Luminary size also presents a challenge. While 2'x2' troffers are typically preferred in a commercial setting, applications using linear fluorescents often use a 2'x4' troffer in order to utilize the most efficient and cost effective fluorescent source.

It is a common misconception that fluorescents are more energy efficient than LEDs. While this can be true by some measures, it really only applies to fluorescent lamps outside of the fixture. For example, a linear fluorescent outside of a fixture may reach 90 lumens per Watt. Once inside a fixture, however, the fluorescent luminary may lose up to 30 percent of its light output perhaps providing only 64 lumens per Watt.

Other known complaints with fluorescent lighting include unnatural color and a flickering effect. Additionally, the use of mercury creates the need for hazardous waste disposal at the end of life or if a lamp should break.

Current LED alternatives on the market bring specific challenges, as well. Color rendering standards for many LED white light sources, as measured by the Color Rendering Index (CRI) typically range from 70–80, well below the full potential for white light. The traditional combination of a blue LED chip with a yellow phosphor creates a distribution of white color that must be binned for the final application. Traditional LED fixtures can experience a certain amount of color shift over the lifetime of the product, and lumen output also degrades over time.

Aesthetically, LED solutions offer a great deal of design potential. But often, in an effort to produce the maximum product efficacy or lumen output, visual comfort is compromised. LEDs may be left unshielded, creating a very intense source of light as opposed to a natural diffusion. While brighter and more direct, these solutions are not necessarily more appealing to the end user.

## Overcoming Challenges

For the design of the lighting fixture, an ideal solution for its target end users meant overcoming each of these challenges. The first and foremost challenge was to address the current color rendering standards of traditional troffers. Foregoing the traditional blue and yellow white light combination, which often leads to color inconsistencies or color change over time, the LR24 combines unsaturated yellow and red LEDs to create a higher-quality white light. The result is a white light with a 92 CRI versus traditional troffers with a 70–80 CRI average. In addition, the two colors together provide the capability to tune the fixture to a specific color point (3500K), which helps to eliminate inconsistencies from fixture to fixture. Finally, an optical sensor, which measures and maintains the color temperature over the lifetime of the product, completes the color maintenance control system. The end result is a highly-uniform product. Going back to the end user experience, these innovative developments mean that someone exposed to multiple LR24s everyday can expect the same color and light output from each of the fixtures over the course of their product lives.

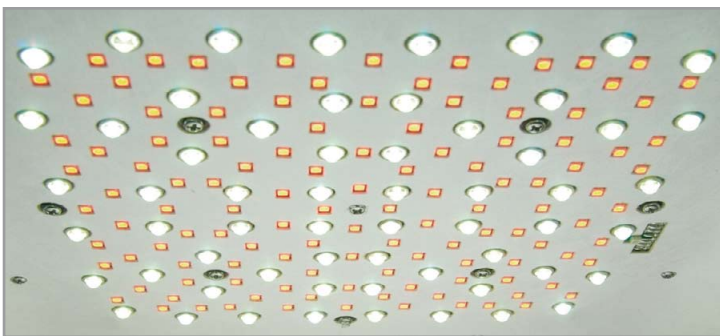

Figure 2: Inside the LR24: Active Color Management technology ensures a stable, even color point

To address demand for a 2'x2' solution with the output of a traditional 2'x4' troffer, thermal management and LED design were key elements. Unlike incandescent and fluorescent lighting, LEDs do not radiate heat away from themselves. If not properly accommodated, this can lead to the LEDs overheating, which in turn affects the performance of the

LEDs over time. For the LR24, an integrated thermal management system was designed to conduct heat away from the LEDs and transfer it to the surrounding environment. The system uses a circuit board mounted directly to the LED fixture. This simple, but highly effective thermal management system enabled the manufacturer to design the LR24 with many tightly grouped LEDs. As a result, the LR24 is much more powerful than typical downlights, allowing for an effective 2'x2' design.

To improve overall aesthetics, which immediately and directly impacts the end user's experience, the team placed an emphasis on optical design. As described earlier, LED fixture light sources are often left bare in an effort to deliver maximum light output. Similarly, many fluorescent luminaires appear very bright from a distance. In large installations standard fluorescent designs appear as scores of bright white rectangles across the ceiling creating a busy look.

The design addresses these challenges via three primary components. First, a combination of reflective and refractive optical components creates a uniform appearance and eliminates any direct view of the LEDs. Second, the lower reflector is finished with a textured, high-reflectance white polyester powder coating. This creates a natural visual transition from the diffuser to the ceiling pane. Finally, the lens is recessed above the ceiling to reduce glare. The result is a luminaire that retains its high efficacy, and projects a subtle, glowing appearance. In addition, the optical system creates an ideal distribution of light with light effectively balanced between horizontal and vertical surfaces. For the end user, this translates to a soft, well-lit, environment.

Finally, electrical design played a significant role in the overall performance. Here, customization played a critical role. Rarely in a fluorescent solution are all of the components designed to work specifically with one another for one particular task. Component pieces are often purchased separately and while they may function properly together, the combination often involves compromises which limit the system's ability to reach its true optimal performance. For example, a lighting solution may use an off-the-shelf driver, which was designed for multiple usages and wattages, and it may use a thermal management system that was designed for another product. The end result is a functioning product made of generic building blocks versus customized, integrated pieces. Each component of the luminaire was designed specifically for this fixture and with the end use in mind. This was a large undertaking indeed, but one that provided full product optimization and control. Ultimately, this sophisticated level of integration and product control enabled all of the design and performance breakthroughs of the new product.

## The Test

One of the most important tests of the new luminaire came from the United States government. The Pentagon, which is undergoing a major renovation, sought out the LR24 for a potential LED lighting solution as part of government leadership effort to make federal buildings more energy efficient. This lighting solution endured rigorous testing and business-case analysis in a comparison with fluorescent technology.

Pentagon studies showed a payback on the investment of less than four years. And, of course, also showed the expected benefits of LED lighting: energy savings, maintenance savings, savings associated with a reduced load on heating, ventilating and air conditioning systems, as well as the elimination of hazardous waste disposal fees.

However, one component of the testing, a preliminary Pentagon installation, yielded particularly interesting results. As part of the analysis, LR24 luminaries were installed in a test room in the Pentagon, replacing the existing fluorescent luminaries. The independent study showed an expected 22 percent reduction in energy usage and improved light quality. In total, the Pentagon switch to these LED luminaries is estimated to save 140 tons of CO2 emissions per year.

But what about the end user's experience? For the Pentagon test, the existing fluorescent fixtures were replaced by an identical number of LR24 luminaries, yet people who viewed the room perceived it to have more light. Anecdotally speaking, visitors perceived the room as brighter, bigger – even cleaner. The walls appeared whiter; the carpet appeared to be a brighter shade of red. The overall effect was of a much improved working environment – one that will undoubtedly be appreciated by the hard-working employees of the Pentagon.



Figure 3: LR24 luminaries, such as the ones shown here, are being used in place of fluorescent fixtures in the Pentagon

## Conclusion

By focusing on the end user, the designers were able to create a fully-integrated, high performance lighting solution, which addresses standard challenges, such as color rendering and consistency, luminaire size and efficacy, electrical optimization and overall visual appeal, to better serve the target audience.

Upon design completion, a new white light solution was created – one that is powerful yet soft and inviting, one that is warm but maintains tight color consistency over its product life and one that is contemporary and visually appealing but can be applied to existing housings and older building designs.

A product's success mostly depends upon its appeal to the buyer and ultimately the end user. Most lighting solutions are created with the buyer in mind. They address business goals such as cost savings, ROI, energy efficiency and LEED certification. But very few products address the needs and wants of the end user. Does the lighting solution help them function more effectively? Is the lighting solution visually appealing and comfortable to look at? Companies should challenge themselves to address the needs and wants of their ultimate consumers – even if it is not requested by the product purchaser.

End user appeal is a critical component of a product's functionality, but one that is often overlooked. By focusing on the end user throughout the design process, a company can go from creating a good product to a groundbreaking one. ■

**NEED  
COOLING?**

Better use PCBs with  
Insulated Aluminium Substrate  
made by SRM!



**SRM**  
PRINTTECHNIK

www.srm-printtechnik.de  
upload@srm-technik.de  
Tel: 030/701900-22, Fax: 030/701900-11





Taipei International Electronics Show

# **TAITRONICS**

- Components • LED •
- CCTV • Wires & Cables •

**October 8–11, 2009**

TWTC NANGANG Exhibition Hall, Taipei, Taiwan

**Go to [www.Taitronics.org/Taipei](http://www.Taitronics.org/Taipei)  
REGISTER & receive FREE**

- **Buyer's Badge**
- **Official Directory**
- **Updates on TAITRONICS 2009**

Find your nearest TAITRA branch and  
learn more about our buyers' incentive program!

*Organizers:*



**In conjunction with**



# Merging Technology and Biomorphic Design

> Christie Liu, BComm Marketing & Lumolar

While common in industrial and commercial applications, consumers generally have not had immersive lighting experiences with LED technology. This rapid expanding field of applications was traditionally evident by the use of LEDs in displays, signs, billboards, automotive lighting, and as equipment status indicators. The introduction of LED lights into interior spaces has been marked by an increasing momentum for the last few years with emphasis on maximizing light output and minimizing the side effect of heat generation through improved heat management. A new fixture series by Toronto, Canada based Lumolar is inspiring growth in the LED technology market via design innovation in the architectural lighting sector.

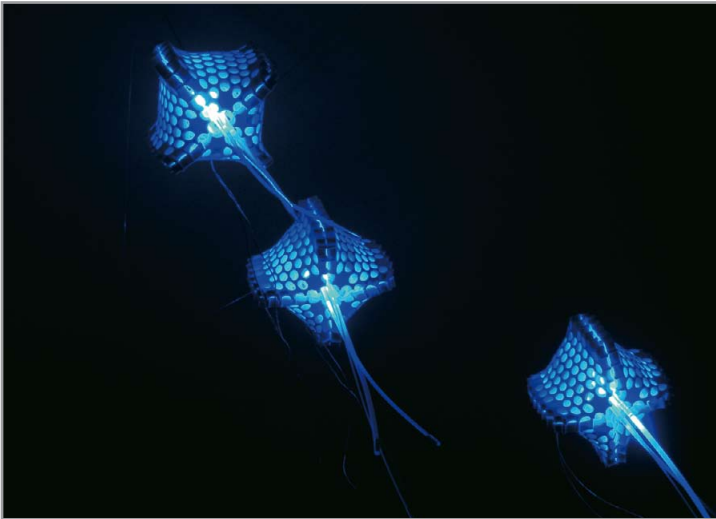

Figure 1: The illuminated "Baby Fish Tide" luminaries

## Morphology

Drawing inspiration from nature and a commitment to the environment, the light assembly metaphorically resembles biomorphic forms and is reminiscent of microbiological cells or larger organisms. Even though the fixtures are man-made objects they appear to be a found object and are esthetically based on biomimicry. The three illuminated strands or tendrils are the vertical imperial interpretation of the "Three Standard Stoppages" by Marcel Duchamp, assisting in guiding the light from the body and complementing the marine appearance. However, the lights are available with different glass or acrylic strands and some are delivered without the tendrils for a more formal aesthetic.

Developing the optics (Figure 2) for these strands was a challenge without the availability of polymer optics (230 color mixer reflector for rebel power LEDs) that only came on market 12 months after the unveiling of the fixtures. Lumolar designed and tested various assemblies of glass and acrylic lenses in 2007 and developed a custom lens that allowed the three individual strands to illuminate all in the same color simultaneously. Originally due to the small diameters of these strands or tendrils unintentional multi-colored strand illuminations were

created. The solution was found in arranging different polished and translucent acrylic surfaces with the proper aluminum reflector bundling the light into the stands and the body. The stands are custom-made optical acrylic rods that are individually formed and arranged to complete the aquatic emergence.

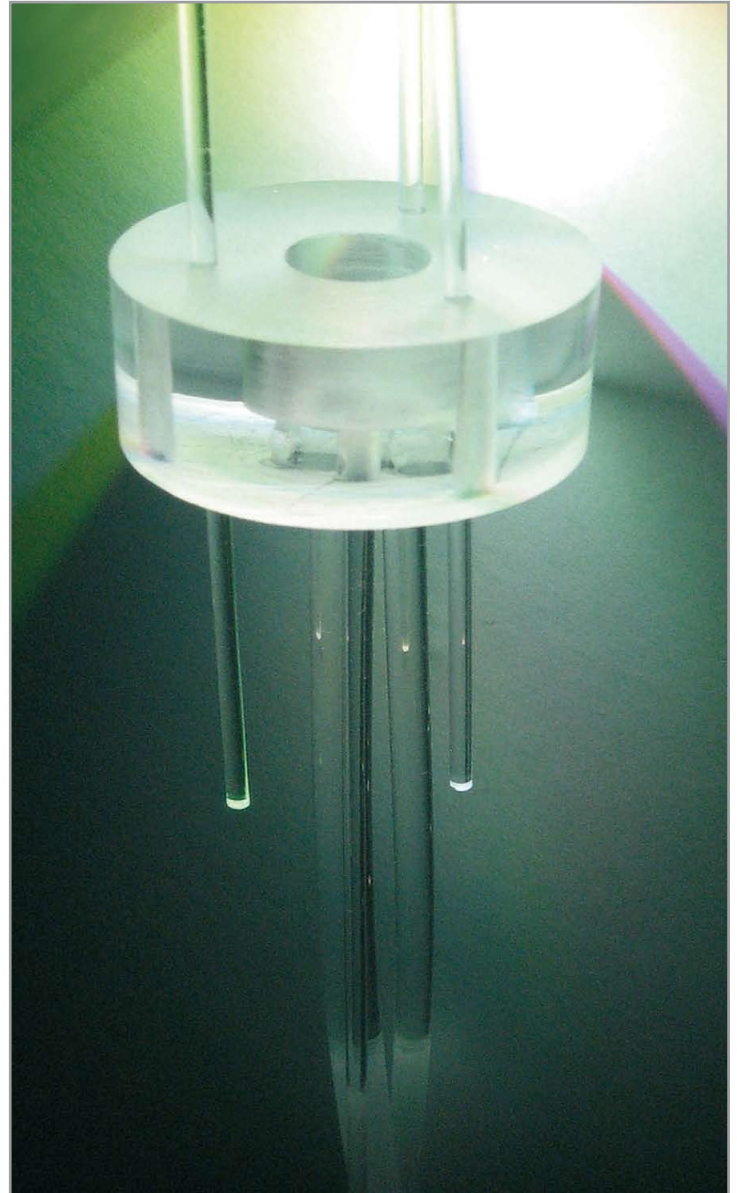

Figure 2: The custom lens for mixing and distributing the light from the Rebel LEDs

## Materiality and Specifications

The material for the light shade of the new light concept was found as a waste product of the automotive and chemical industry. Through this up-cycling process it inherits its own initial sustainability rating by diverting waste from landfill. The material of the light shade is 100 percent natural felt in a white finish with industrial strength. Made from sheep wool, it is chemical free and has in itself a low environmental impact in original manufacturing. The industry only needs the round cutouts for glue applications. As such, the perforated felt is a negative product that is no longer of any use to the industry. As an interior design material, it has

excellent fire retardant properties and is self extinguishing which makes it an optimal lampshade material. The shade is assembled in a patent pending process without the use of any glue and could be used as organic fertilizer should one ever decide to part with the product.

The lights have a base white color LED source of 3300K or 5500K. An RGB star formation facilitates unlimited adjustment of the light color on the Munsell chart and allows electronically pre-programmed choreographies or daylight simulations. Phillips Lumileds Rebel LEDs were chosen due to their inherent small footprint, since the space inside the light and the transfer of the light through the optics is limited to a small area. This set up is paired with a Cypress dynamic solid state color control system. The system was conceived at that time when there was restricted availability of color controls for LEDs and a cross between available and custom made components was chosen. As such, the designer opted for the Cypress system EZ-Color chip with some custom-made boards. The system runs with a 5000 frame count for pre-programmed color choreographies at a maximum frame speed of 25 Hertz and a master board that can control up to 90 fixtures.

By using LED technology as a light source, energy consumption is significantly lower than conventional lighting by up to 80 percent. This reduced energy requirement can be supplied by any power source and certainly also solar power or any other environmentally conscious power generation according to the customers specification.

The average life span is 50.000 hours at continuous usage. The size of the space determines the number of lights to be utilized and ranges from three to seven for small rooms up to 50 to 100 for larger spaces. A free space specific set up or cluster is the most successful metaphorical arrangement for any number of lights. The size of the individual unit is 150mm diameter shade with three +300mm strands.

## Impact

LED daylight simulation tests on workers have demonstrated positive psychological and emotional results. This general improvement of well-being leads to higher productivity levels. The right color of light can be used to reduce the effects of SAD (Seasonal Affective Disorders) in areas of reduced sunlight exposure. Compared to fluorescent lights, LEDs are manufactured without lead or mercury, have a significantly longer life and lower energy consumption. Felt in itself is environmentally friendly since it is all-natural and the dust from manufacturing is not harmful and as mentioned can be used as organic fertilizer. Unlike bio-plastics, the animal hair is not a food source for human nutrition. The up-cycling process reduces landfill volume and the patented mechanical fastening system requires no chemical glues for assembly. Due to the up-cycled felt material and LED technology, the product can be thought of as being "100 percent green" and will be featured in the upcoming "Green Ovations" Trade Show in Toronto in April.

## Context

The lights were initially designed for a sushi restaurant allowing the space to have very slow changing ambient light color or changes exclusively on a daily basis. Lumolar's light designer and partner Mark Tholen prefers to go deeper into Duchamp's philosophy and created an aura around the lights based on 'Pataphysics\*': 'The product originated

from the depth of the sea, was carried towards the surface of the ocean and to shore. Was found within the driftwood and taken to be used as a light shade at a sushi restaurant'. During a Chinese wedding, these lights resembled the bride's changing wedding dresses through their color changes – from the white western wedding dress the bride wore at the beginning of the event, to the traditional red Chinese gown. The impact was significant as the lights transformed the space and themselves from a symbol of purity to fertility.

The unusual biomorphic shape is at the same time a drawback since it may not be compatible with all interiors. The lights require a simple modern surrounding space or a space that is comparable in ideology to the aquatic theme since they are very strong in their own form. The first generation of lights (2008) functioned only with a connection to a computer. 2009 will see the introduction of independent lights that are controlled by a small remote control. This remote is based on touch control without any moving switches or components. The lights are hung from custom made ceiling hooks with a very simple and effective 180-degree slip on connection. Patents and trademarks are pending on assembly processes, electronic remote control and product names.

Lumolar unveiled the soft shell "Baby Fish Tide" fixture series in January 2008 at the Passagen show in Germany, in a space with 60 lamps with constantly changing color. Passagen is a show that runs parallel to the International Furniture Fair IMM in Cologne. The lights were shown in North America for the first time at the IDEX 2008 in Toronto Canada, showcased in the Lumolar booth as well as a cluster above the champagne bar sponsored by the Canadian Design Magazine Azure. Here a blue water color change was displayed that was reminiscent of a water reflection painting by the artist "David Hockney" in moving color value changing LED's.

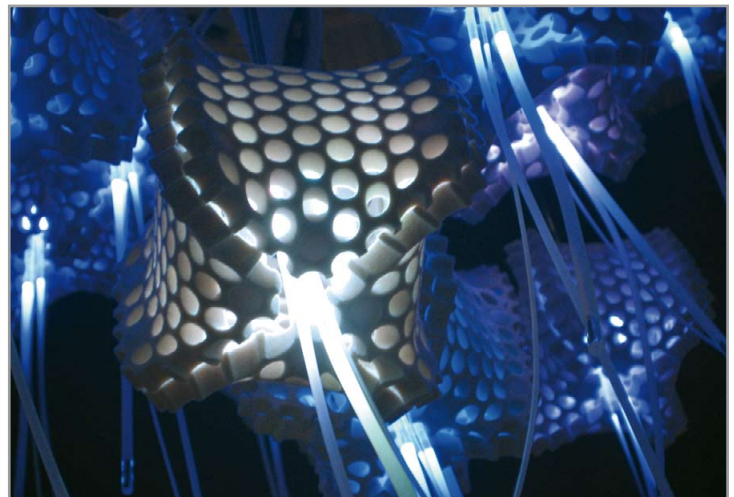

Figure 3: Blue water colored "Baby Fish Tide" cluster above the champagne bar

The lights won an Award of Excellence from the Ontario Association of Architects, a Best of Canada 2008 Award from Canadian Interiors Magazine, and a Design Exchange Award 2008 from the Toronto Design Exchange emphasizing and manifesting the importance of the consistence of new technical developments as a combination between technology and design. ■

### References:

\* Science journalist Zoë Corbyn offers this definition in "An introduction to Pataphysics", The Guardian Dec 9, 2005.

## Light 2.0: LEDs Create an Entirely New Generation of Lamps

> Andreas Biß, New Business Development, Sharp Microelectronics Europe

According to the International Energy Agency (IEA), around 2650 terrawatt hours are used across the world every year for lighting alone. A consumption level with enormous potential for savings: in comparison to traditional light sources such as electric filament lamps, fluorescent tubes, halogen lamps, sodium and mercury vapour lamps etc., modern light sources only need a maximum of just less than half the energy. LEDs are one of the light sources with the highest energy efficiency on the market today. With a lighting efficiency of e.g. 90 lumens per watt depending on the module, they use only 11% of the power used by normal bulbs. Even conventional low-energy light bulbs still use twice as much as LEDs.

### LEDs – Cost-Efficient Even After Only 1500 Operating Hours

In addition to high energy efficiency, a long-term advantage of using LEDs as a light source is their long life cycle. Well designed LED modules provide at least 40000 hours of light at a substrate temperature of up to 80°C, depending on the module. Despite the comparatively high purchase costs, using LEDs as a light source pays off throughout their total life cycle (some have already done so today). According to recent calculations, LED lights already have an advantage of around 1,500 operating hours over electric filament lamps in terms of costs. Even in comparison to

fluorescent tubes, the break-even point for costs is around 8000 operating hours, i.e. after a sixth of the life cycle of LED lights. If you consider the high maintenance costs for hard-to-access applications such as streetlights, where changing the light source is extremely time-consuming, the total cost savings generated by LEDs in comparison to traditional light sources come to a total of around 38 percent. Some utilities companies are already converts: EnbW in Baden-Württemberg and the Italian company Enel Sole have already initiated pilot projects for LED-based street lighting. The latter intends to install 40000 streetlights with LEDs as the light source over the next two years.

### Environmentally Friendly and Climate-Neutral

LEDs have further advantages in particular over fluorescent tubes and metal vapour lamps: firstly they contain no mercury and secondly they are easy to dim, which means lights in the street or in offices can simply be turned down depending on the time of day or usage – which also saves energy. Thirdly, their low supply voltage with direct current predestines them for use in so-called solar lighting systems, where lamps are powered by batteries independently of the mains supply. These batteries are charged during the day via photovoltaic panels. Both LEDs and photovoltaic cells are thus key components for CO<sub>2</sub>-neutral street lighting.

### LEDs – Wide Ranges of Colours and Forms for More Freedom in Light Design

In principal, LEDs are suitable for universal use as light sources for lamps, not just in streetlights: in interior spaces, e.g. for study, reading and desk lamps, decorative lighting, direct and indirect lighting for work surfaces in kitchens etc., as spotlights for stages and building sites or as components for LED large displays. The LED modules are also a long-

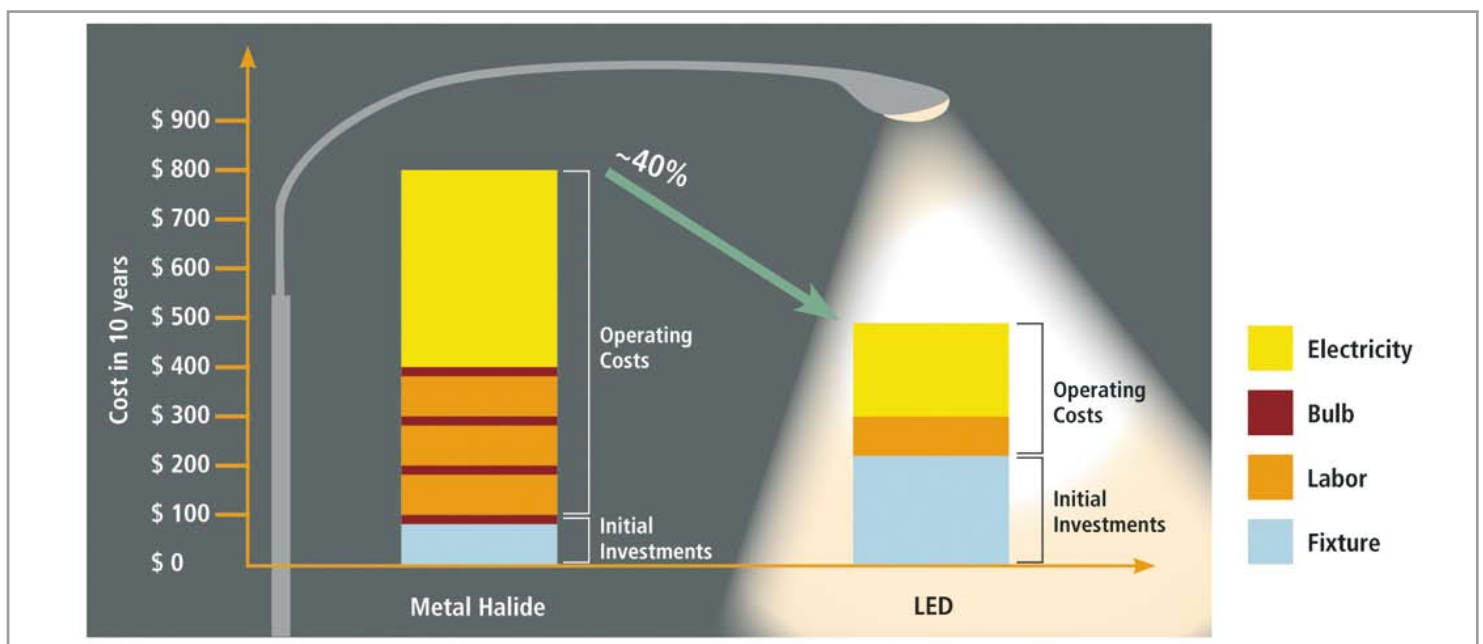

Figure 1: LED costs comparison – despite higher initial investment costs, street lights pay off after 8-10 years due to reduced energy and maintenance costs

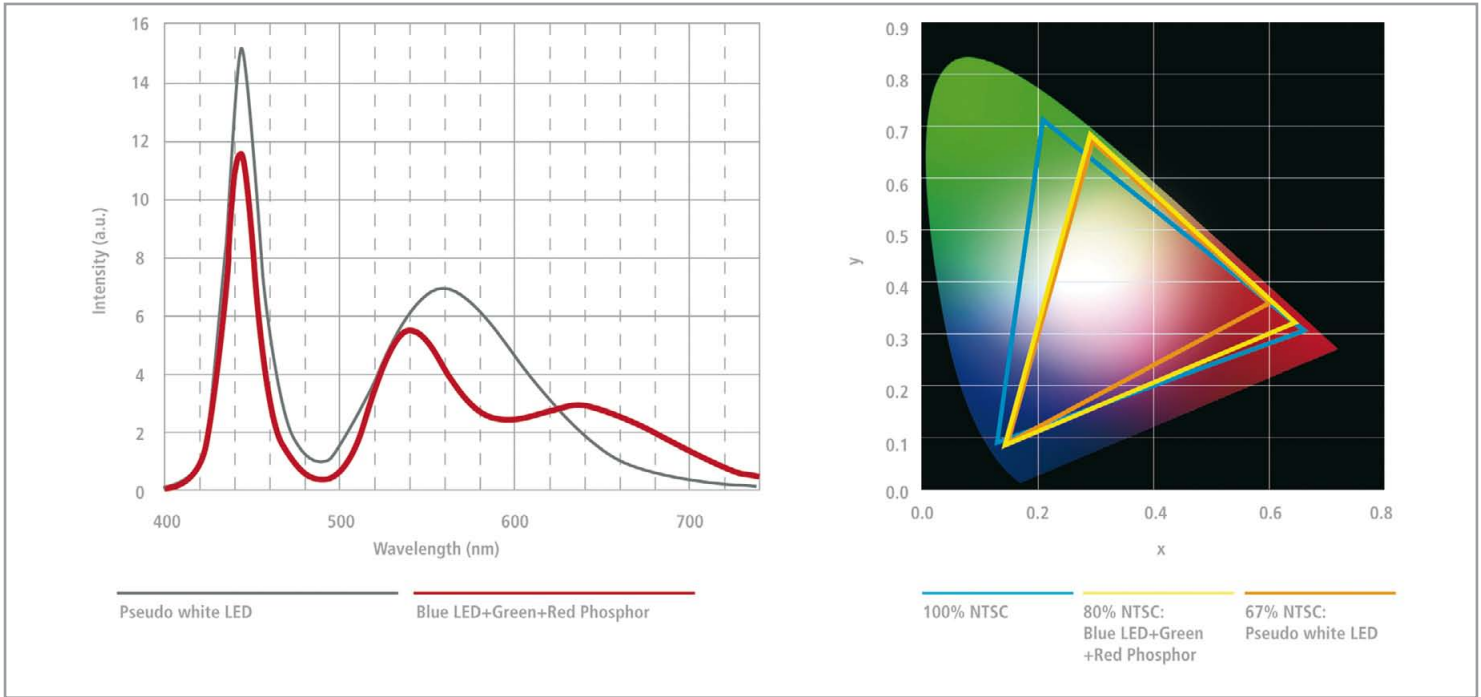

Figure 2: High CRI LEDs with red and green phosphors offer an improved colour rendering and natural colour space

lasting solution for reading lamps on public transport such as trains, aeroplanes and buses. However, the different applications have their own individual requirements for light output, colour temperature and form factor. For the wide range of lighting applications, a correspondingly wide range of LEDs for lighting purposes is available on the market.

Despite all the differences, all LEDs have the same design in principle: they consist of a blue diode with a phosphorus coating. In addition to traditional yellow phosphorus, some manufacturers also use a mixture of red and green phosphorus. This means that these diodes cover a wider area of the natural colour space.



Figure 3: Other than most light sources, LEDs can be manufactured in a wide range of CCT from 2200K to over 11500K, making LEDs the first choice for different applications from residential lighting to medical applications

LEDs can be manufactured in a large range of different colour temperatures. With traditional light sources, the physical properties of the gas filling and/or of the coatings of the glass skin dictate the wave spectrum of the light, which provides only a small amount of leeway in the adjustment of the light properties. With white-light LEDs, specific colour temperatures can be achieved by altering the proportions of red

and green phosphorus in accordance with the relevant mixture. Theoretically, white-light LEDs can be manufactured with a specific colour temperature for every application. In practice, e.g. Sharp supplies white-light LED lighting modules in four shades - 'Normal White light', 'Warm White light', comparable to a light bulb, and two shades in the field of 'High Colour Rendering White' - whereby the colour temperature lies in the range of 2200 to 11500 Kelvins. Light sources with warm white light up to approx. 3000K are mainly suitable for lighting living spaces, light sources in the average temperature range of 3000 – 5000K are intended for use in general commercial lighting applications such as those in offices, public buildings and factories, whereas cooler colour tones of 5000K and more are particularly suitable for applications with high contrasts, e.g. in the medical sector.



Figure 4: The closer CRI comes to the maximum of 100, the more natural and vivid the colours of an illuminated object are rendered

By means of varying phosphorus mixtures, the two 'High Colour Rendering' LEDs attain a CRI level of up to 90 and thereby provide high colour fastness and fidelity to detail. This is of significance in all circumstances in which artificial light may not falsify the depiction of the illuminated objects. 'High Colour Rendering' LED modules are for that reason particularly popular in areas such as photography, window-dressing for shops and the presentation of goods, and also in medical technology e.g. for OP lamps.

The compact design of LEDs provides designers with new freedom in the design of their light sources. Instead of designing lamps as a shield around comparatively large-format light sources, LEDs can be used with great space savings and therefore do not necessarily dictate the overall form of the lighting application. This also means that integration into, for instance, items of furniture, ceilings, as reading lamps, car roof interiors etc., becomes substantially easier. E.g. "Type 3228" LED modules measure as little as 3,2x2,8x0,9 millimetres. The smallest components in the white-light diode sector are Ultra Small Package LEDs, with an edge length of 1,6x0,8x0,2 millimetres. Even the high brightness module from the Zenigata series, measuring 18x18x2 millimetres, is much more compact than the traditional light sources. Furthermore, LED-based lamps are much less complex systems: the starters that are needed for fluorescent tubes and low-energy light bulbs are unnecessary here.

### Modular Design for High Product Flexibility

In total, the Sharp LED lighting module range comprises just about 30 different types. The greatest light output is provided by the 540 lumens series from the Zenigata range. This module has a light output of up to 540 lumens with 6,7 watt current consumption, achieving a level of brightness equivalent to traditional 40 - 60W light bulbs. Its little sisters from the 280 lumens series are similar in design, with 3,6 watt current consumption and a level of brightness equivalent to 30 - 35W light bulbs. Anyone who needs more compact light sources with equally high light output can go for the so-called Flash-Brick module (for example), which supplies up to 39 lumens with power consumption of one watt. Even smaller LEDs, like the "3228" LED chips with a light output of 3,5 lumens upwards and a radiation angle of 120°, are useful for different applications.

This high flexibility in light source design is achieved through the modular construction of its LED components. The basic modules are individual blue LED dies coated with phosphorus, connected together in a matrix and housed on a printed circuit board. For example, the high brightness module from the Zenigata series consists of 48 dies for the 6,7 watt versions, while the Flash-Brick models only use four dies, connected in series or in parallel depending on the model.

### Colours for More Light Design

In addition to the comprehensive portfolio of white-light LEDs for general lighting purposes, a broad range of RGB and monochrome LEDs is available to address the decorative lighting and light design market. Besides the standard colours - yellow, red, green and blue - special

colours in pastel tones are available: extraordinary design accents can be created deliberately in architecture and interior design using light blue, lemon yellow and violet.

Various RGB 3-chip LEDs for light designs across the entire colour spectrum are on the market. The three LED colours on the RGB chips can be controlled separately, allowing for a smooth flow of colours across the entire spectrum from yellow to blue. In order to house such colour effects in even the smallest of applications, very small RGB 3-chip LEDs in ultra compact form with edge lengths of e.g. 16x1,6x0,55 millimetres offer extraordinary design opportunities.



Figure 5: White lighting LED packages with different power and lumen output for various applications

### Conclusion

Given their energy-saving potential and long life cycle, LEDs will rapidly gain in significance as light sources for general lighting and lamps. By 2012, lighting applications will grow to a volume of approx. USD 1,4 billion with a proportion of 12 percent on the overall LED market.

Crucial for their breakthrough on the market-place for light sources is the light output of the LEDs - what manufacturers want here is an efficiency above 100 lumens per watt. Once this hurdle has been overcome, the advantages of the LEDs are overwhelming: long life cycle, compact form factor, low system complexity, high energy efficiency, no pollutants and finally a wide range of different colour temperatures. Monochrome colour and RGB 3-chip LEDs will also allow the creation of designer light effects that would simply not have been possible to this extent with traditional light sources.

By using LEDs as light sources in so-called retrofit lamps, it is already possible today to substitute conventional light bulbs and low-energy light bulbs, so that consumers can also directly benefit from the advantages that the new light source technology is ushering in. ■



The logo features the letters 'LED' in a stylized font where the 'L' is a vertical bar, the 'E' is a horizontal bar, and the 'D' is a vertical bar. To the right of 'LED' is the year '2009' in large, bold, multi-colored digits (red, green, blue). Below 'LED' is the word 'LIGHTING' in a smaller, white, sans-serif font. Below '2009' is the word 'Taiwan' in a large, white, sans-serif font.

# LED Lighting Taiwan

The 5th Int'l LED Lighting Exposition

<http://www.optotaiwan.com>

**June 10-12, 2009**

Taipei World Trade Center, Hall 1

## Exhibits

- **LED Lighting Fixture**  
Indoor, Outdoor, Specialty  
Decorating, Landscape, Architecture, Garden  
Control System & Accessories
- **LED Applications**  
Automotive Lamps, Backlight, Display Board, Traffic Signal, IrDA, etc.
- **Package / Module**  
Lamp, Dot Matrix, Cluster, SMD, etc.
- **Epi Wafer, Chip**
- **Materials**  
Substrate, Ingot, Phosphor, Lead Frame, etc.
- **Processing Equipment**  
Wafer (MOCVD, Mask, Etching)  
Assembly (Dicing, Bonding, Packaging)  
Testing (Prober, Aging)

## Organizer



Photonics Industry & Technology Development Association

5F, No.9, Roosevelt Road, Sec.2, Taipei 10093, Taiwan

Overseas contact :

Pamela Hsiao

E-mail : [exhibit@mail.pida.org.tw](mailto:exhibit@mail.pida.org.tw)

Tel : +886-2-2351-4026 ext. 805 Fax : +886-2-2396-8513

# The Future of LED Illuminators

> John Popovich, Founder, Column8

Technologies are introduced that enable the design and manufacture of illuminator systems with increased efficiency, flux, radiance, controllability, reliability, durability, viewability, and design freedom and with reduced cost, mass, volume, and thickness.

Radiation from LEDs is introduced into edge regions of transparent waveguides and maintained within the waveguides by total internal reflection until encountering scattering regions which act as secondary emitters. A portion of the radiation from the secondary emitters escapes from the waveguide and creates a virtual source which is collimated by an external concave mirror that reflects the radiation back through the waveguide. The edge pumped waveguide illuminators incorporate novel means of radiation entry, transport, escape, and control.

Auxiliary waveguides are used to homogenize (mix) radiation from the LEDs, increase entry flux and radiance, and to allow the placement of LED arrays normal (perpendicular) to the parent waveguide edges to allow for an increased number of LEDs and improved thermal and electrical subsystems. Close packed LED arrays are attached to thin metal enclosures and the heat from LED operation causes liquid flow within the enclosures via phase change driven passive internal micropump arrays. LED costs are reduced by homogenization and the consequently relaxed LED electrical and optical specificity and by an integrated thermal management scheme that allows the LEDs to be operated in closely packed arrays and at increased current densities while providing temperatures consistent with high efficiency and long life.

The system provides compact efficient illuminators with cellular (local) and global (overall) control of the field of view (angular extent) of the emitted radiation, reduces the effects of emitter (LED) outage, and allows the use of LEDs with wide variation in electrical and optical specifications via homogenization.

Many applications can be fulfilled by illuminators that combine waveguides, secondary emitters, and compact cellular collimator arrays in thin film composite structures that may be produced in roll-to-roll manufacturing processes.

Optical reversibility enables the illuminators to be used for detection and high data rate optical communication. LEDs are capable of functioning as detectors as well as emitters and may use brief off states for detection and communication while continuing to provide illumination. Edge pumped illuminators/detectors with global concave or convex form can provide increased field of view and thereby increased illumination, communication, and detection opportunities.

## Light Mixing and Distribution

### Waveguides

Waveguides allow thin section illuminators of complex form, provide homogenization to mask variations in LEDs, and are an important part of the illuminator technology presented (Figure 1).

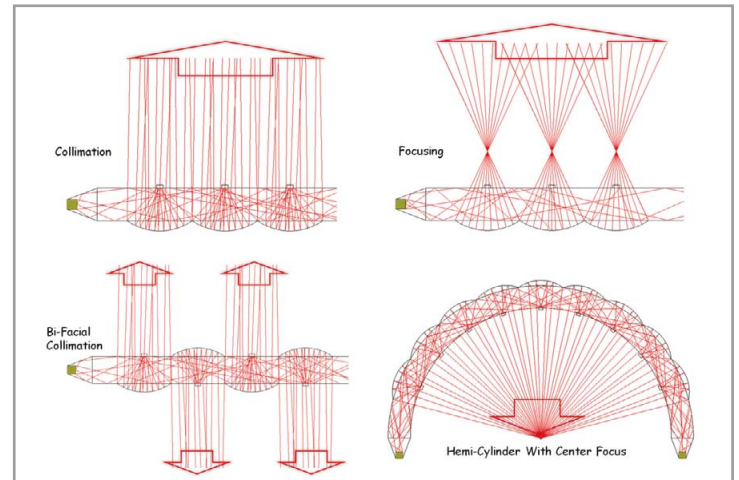

Figure 1: Some possible variations of illuminators with waveguides

Sawtooth auxiliary waveguides (Figure 2) provide premixing, allow thinner waveguides, and offer means to increase flux by a factor equal to the sawtooth auxiliary waveguide refractive index by increasing the angular extent of the radiation in the plane of the waveguide to  $\pm 90^\circ$ . Additional benefits include increased area for introduction of radiation from the LEDs beyond the limits defined by the parent waveguide edge cross-sectional area. The increased entry area can be used to increase radiance by overfilling and color addition. Radiation from "colored" LEDs with non-overlapping spectrums can be added in the same parent waveguide edge space to increase radiance and color gamut. Further connective elements such as tees are used to span the height between the waveguides and the LED arrays or to provide thermomechanical compliance via the use of elastic material such as silicones.

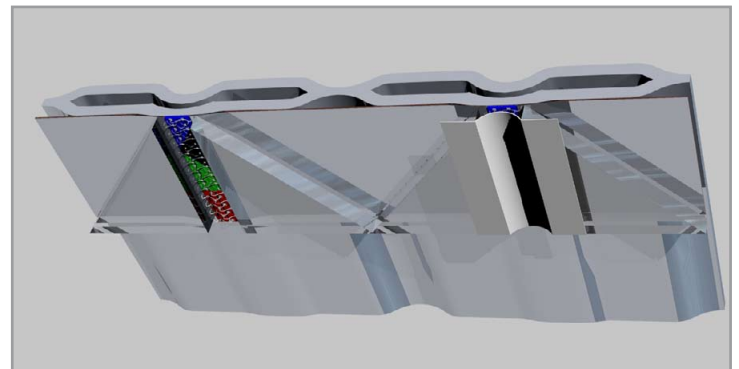

Figure 2: Cross section of a system using an auxiliary waveguide

Hierarchical waveguides (Figure 3) provide increased flux and increase or make more constant the radiation available to secondary emitters while still allowing small collimator cell size for reduced cost and thickness. Radiation transport between hierarchical waveguides is controlled by



varying the refractive index, size, and placement of intermediate contact regions between the waveguides. Windows can be used as waveguides via edge pumping and thin composite film illuminators are brought into optical contact with the windows to create hierarchical illuminators. Windows offer strength, weatherability, and sufficient thickness for illumination of large areas. Windows may become a source of controllable light and heat while remaining substantially transparent. One or both sides of windows act as light or heat sources. Waveguide illuminators may also form walls, ceilings, and floors, and they may provide radiant heating, communication, and detection in addition to lighting. Windows may allow sunlight to pass thru and adjust light and heat output to comply with needs. Aluminum windows are attractive candidates for lighting conversion as the aluminum surround can be used for heat transport and electronic enclosure.

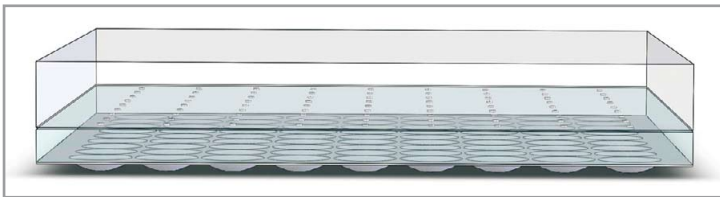

Figure 3: A hierarchal waveguide basically consisting of the LED coupling, the primary waveguide with attached secondary waveguide using a transparent coupling medium with embedded secondary emitters, a diffusion layer and a micro-collimator array

The waveguides require high transparency materials to reduce absorption and scattering and low reflectivity surfaces to reduce losses from partial internal reflection. Waveguide materials include water white glass, cast acrylic, optical grade polycarbonate, and silicones. Graded refractive index surfaces can best provide the bandwidth and field of view needed and may be manufactured by addition, subtraction, and deformation. Protective covers are needed in some environments to reduce partial internal reflection losses from contamination.

### LED array organization

Organizing LEDs into parallel linear arrays normal to the parent waveguide edge allows a greater number of LEDs and provides an increase in the effective area for thermal communication. Heat from the LEDs is used to actuate parallel arrays of passive liquid micro-pumps and a space between the pumps allows improved flow organization. The electrical circuitry for LED operation is simplified by allowing a single conductor layer to access all emitters in series and/or parallel configurations. The increase in plan form area required to accommodate the normal LED arrays can be minimized by minimizing the spacing between the LED arrays.

### Secondary emitters

Secondary emitter optical systems allow much greater electrical and optical variation in LEDs via homogenization of the radiation from the LEDs and this is a very important consideration because the cost of LEDs increases dramatically with electrical and optical specificity. Directly lit LED illuminators require more closely specified LEDs, greater thickness, and their emitter outages are more obvious to viewers. LED

traffic signals provide a prime example of the effects of LED outage in directly lit LED luminaires and of the poverty of this strategy.

Secondary emitters can be smaller than primary emitters (LEDs) and this allows smaller collimating systems because optical systems are radiometric, a larger emitter requires a larger collimator. Secondary emitters can be more or less numerous than primary emitters.

Secondary emitters allow the power, control, and heat transport subsystems to be remotely located and this allows waveguide subsystems with reduced cost and increased freedom of form. Medical, health, and explosion hazard environments are potential markets.

Proper color composition requires a much larger number of green than red or blue LEDs and it would require a very large pixel size to accommodate the appropriate number of LEDs at each pixel in a directly lit illuminator. Red, green, and blue colors in the proportion of 6:3:1 is a common approximation of the level of each additive primary color required for good color composition. If this composition is to be provided in a directly lit illuminator, it implies a large number of LEDs per pixel or paying for LEDs that operate at a very low level and consequently at very low economic value. In an edge pumped illuminator the proper proportion of LEDs can easily be provided and homogenized to reduce the variations between LEDs. Edge pumped illuminators can easily accommodate a further increase in the number of colors for improved economics or color gamut.

Enhanced spectrum illuminators may provide ultraviolet radiation for health maintenance or tanning and infrared radiation for heating within the same waveguide carrying visible spectrum radiation because the spectral emission regions are non-overlapping. Spectral addition via LEDs made reflective to radiation outside their emission region or via the use of thin film photonic crystal filters.

Secondary emitters provide greater freedom of form and scale. Secondary emitters may vary in plan form to aid in the control of the angular extent of the output radiation, e.g. illuminators can be provided with greater field of view in the horizontal axis by secondary emitters that are more elongate in the horizontal axis. Secondary emitters are arranged in lines or complex and intricate patterns. An artist may paint with light by creating secondary emissive regions as desired.

Secondary emitters, e.g. phosphors, may provide white or colored light with a single type of pump LED. Blue or ultraviolet LEDs activate phosphor secondary emitters and secondary emitter regions may exhibit a single color or a blend of colors chosen by the lighting or signage designer. The phosphors are dispersed in polymers and deposited by inkjets. Dyes and quantum dots can also be used as secondary emitters.

"Lighting may be tuned for a space or a whim." The presence or absence of dots or lines (secondary emitters) can be used to tune a light to a space. Luminaires may be made with accessible emitters to provide for "reprogramming" of the luminaire. Users may add, remove, or modify the secondary emissive regions. Linear secondary emitter regions (lines) can be selectively removed to tailor far field illuminance or reduce secondary emitter far field imaging. Manual programming means include the use

of paints or inks or removable dots and lines via pressure sensitive adhesives. Users may remove or add dots and lines with desired colors in the appropriate positions on the luminaire. Ink jet printers can create secondary emitter arrays for lighting and signage.

Secondary emitters could be electrically operated reflective liquid crystal regions (switchable secondary emitters). Switchable secondary emitters in this system are a type of optical amplifier in that they occupy only a small part of a luminaire emission region but control a much larger luminaire emission region with beneficial effects including reduced operating power and reduced obscuration from liquid crystal cells and associated conductors. Bi-stable reflective liquid crystals switches are well developed and are being incorporated into low cost retail products. Switchable secondary emitters provide tempo-spatial control to illuminators and enable energy savings by providing the right light at the right time and place. Signage and displays are candidates for switchable secondary emitters with signage being easier due to the reduced need for resolution and update rate and the ability to use very low power bi-stable liquid crystals. Seven segment character signage and display is an application that does not require high resolution or update rate. Switchable Secondary Emitters provide greatly increased utility and will lead to a merger of lighting, signage, and display products.

Radiation from secondary emitters outside of the escape region fills the waveguide to its angular capacity in plan and section and thereby reduces the variation in secondary emitter to source apparent field of view with varying distance from source. By placing LED arrays on opposing or additional edges of waveguides, the variation in radiation available to secondary emitters can be further reduced. Multiple pass and hierarchal waveguides are additional means to reduce the variation in radiation available to the secondary emitters.

Secondary emitters must occupy sufficient area of the illuminator output surface to satisfy the constraints associated with conservation of radiance or suffer a degradation of efficiency. Radiance can be increased by using emitter areas less than radiation entry areas (overfilling) but with some loss of efficiency.

## Painting with Light

The technology enables the creation of lighting, signage, and art with controllable field of view, brightness, and color. Illuminators without secondary emitters allow lighting and signage designers to create custom products. Inkjet printers currently used in the sign industry have optical location capability that can be used to determine the location of the cellular reflectors via fiducial marks. Secondary emitters may vary in size, color, form, and symmetrical relation to the underlying reflector cells to create the desired features. Compact cellular collimator cells may be made small relative to the desired text or features. The time and cost of illuminator customization is reduced.

Lighting, signage, and art can be created at point of use by selective placement of secondary emitters. The secondary emitters usually are dots or lines created with paint or applied by pressure sensitive adhesive

(tape). The luminaire, seen as a "canvas", can be painted to direct light and heat where desired and to provide attractive direct viewing. Logos, signage, and art may exploit absence of light by leaving regions of the illuminator without secondary emitters to create reverses. A single illuminator can illuminate several separate and distinct regions of a space with light differing in brightness and color composition.

### Compact cellular collimators

Ninety-degree rim angle parabolic reflectors of rotation or translation are ideal collimators but circular and spherical forms are typically easier to manufacture and are sufficient for most applications. Circular/spherical forms with a 37° half-angle provide good collimation. Hexagonal cells and linear reflector arrays provide 100% space filling.

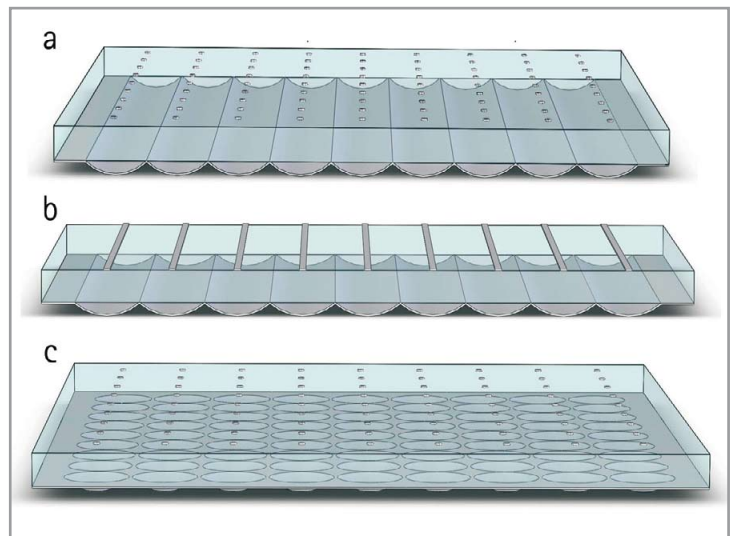

Figure 4: Collimating cell array variants: Linear reflector array - circular secondary emitters (a), linear reflector array - linear secondary emitters (b) and circular reflector array - circular secondary emitters (c)

Asymmetric and locally varying secondary emitters and reflectors are possible and the optical properties of symmetric and asymmetric reflectors may be modified by the addition of refractive elements within the reflector cavities. Polymers may be dispensed by programmable ink jets and may be applied in multiple layers to control shape, vary refractive indices, or create GRIN lenses. The deposited media may acquire symmetric or asymmetric planar, convex, or concave form by means including contact angle engineering, gravitational orientation, and repeat deposition and curing cycles. Convex lenses can be created by the deposition of a small amount of viscous polymer in a centric or eccentric region of a reflector followed by curing and repeat deposition to generate the desired form. It may be easier to manufacture a reflector array of common cellular nature, especially of spherical form, as it is typically the simplest to manufacture, and to vary the optics at the cellular level by other means. Additional radiation control means include microlenses, faceted reflectors, faceted refractors, stepped arrays, and integrators. Signage and high mounted displays often illuminate an upper hemisphere needlessly due to system symmetries and the ability to direct all radiation to the lower hemisphere allows increased radiance or energy savings and reduces night sky pollution.

Compact cellular collimators can be used to create a matrix of beamlets of equal angular extent across an entire illuminator field or to project logos, images, art and information. The reflector arrays can be manufactured from metallized molded forms, metallized films, microlaminate films, and aluminum foil or sheet. Segmented reflector optical software is useful for the design and analysis of compact cellular collimator optical schemes.

**Global illuminator form and design**

Concave illuminators have a larger effective field of view than planar illuminators and can provide smaller focal regions and higher illuminance than planar illuminators and thereby allow passage thru apertures of reduced extent for spot lighting or to reduce the cost, size, and throw length of projection illuminators.

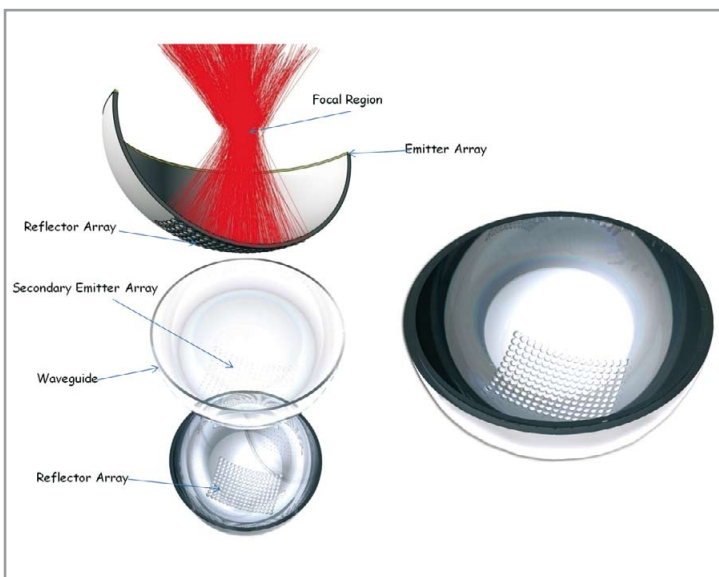

Figure 5: An example of concave illuminator design

Convex illuminators have a larger effective field of view than planar illuminators and may allow a reduction in the number of illuminators and thereby a reduction in purchase and installation costs of lighting systems. LED arrays, situated at the perimeter of a domical shell or in external or internal radial arrays, feed sawtooth auxiliary waveguides.

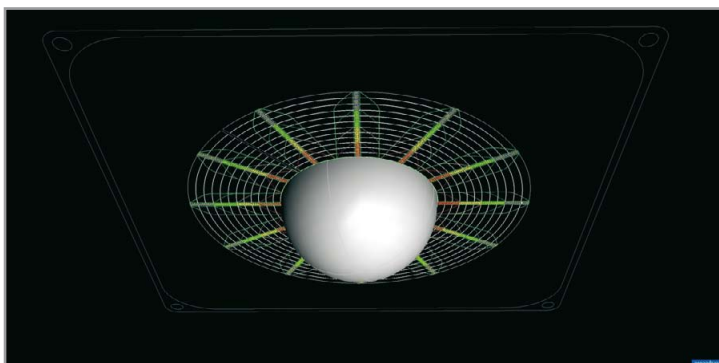

Figure 6: More or the less the inversion of Figure 5 is the convex illuminator

Reflector array forms include circular cells, annular troughs, meridional troughs, and helical (loxodromic) and contra-helical troughs and circular cell arrangements. The illuminators may have varying cell size with "latitude" to increase fill factor or for photometric reasons. Secondary emitters may be electrically operated reflective liquid crystal cells. The simplest X-Y conductor grid on a domical element is provided by crossed helical (contraloxodromic) lines, and this may also be a useful compact cellular collimator array geometry. Electronic power and control means could be contained within the dome.

The cellular nature and thin section of the illuminators provides increased freedom of form. Potential benefits accruing to curvature include freedom of form, increased stiffness/mass, increased stiffness/cost, increased field of view, increased focal plane flux density, increased spatial control, and increased spatial detection capability.

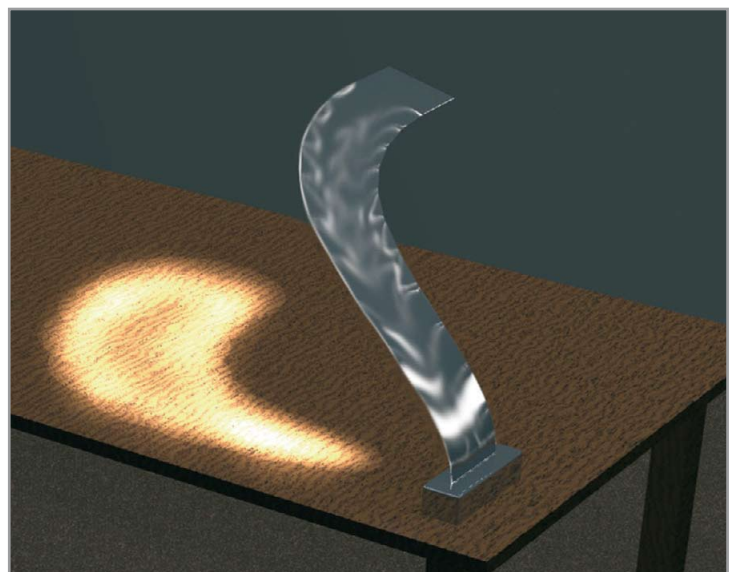

Figure 7: The technology allows also unusual designs or automobile lighting, e.g. via thin skin illuminators conforming to the automobile surface

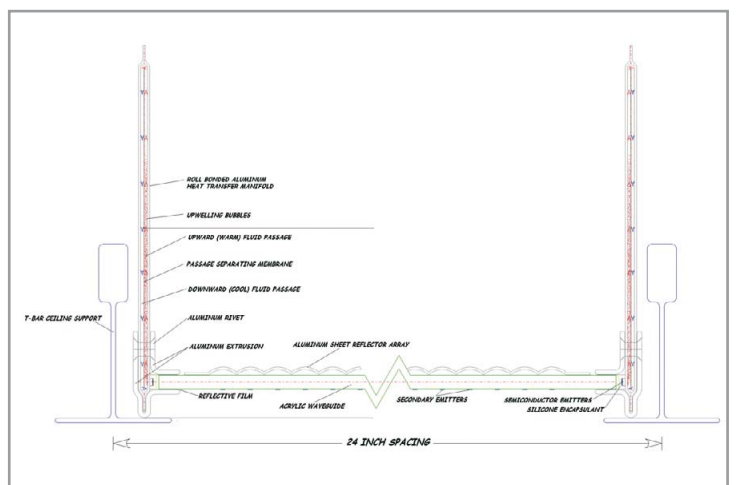

Figure 8: Cross section of the T-Bar ceiling downlight that could replace today's fluorescent lamp solutions

Planar illuminators such as the T-bar configuration depicted may offer improvements in lifetime, color, far field illuminance controllability and increased brightness compared to fluorescent luminaires.

### Planar illuminator

The planar illuminator Megalux depicted is a very high brightness linear unit containing 2240 standard size LEDs in 40 arrays with 10cm spacing. The LEDs feed an anti-reflection coated 0,08cm thick cast acrylic waveguide with a square aperture of 10cm side length. The radiation entry (cross-sectional) area of the parent waveguide is  $0,08\text{cm} \times 10\text{cm} \times 4\text{ sides} = 3,2\text{cm}^2$  and the aperture area is  $10\text{cm} \times 10\text{cm} = 100\text{cm}^2$ , which yields an aperture area/entry area ratio of  $\sim 30$ , and allows a similar ratio of linear collimation, or a linear illuminator with a  $\pm 3^\circ$  angular extent.

Commodity grade LEDs allow a collective color luminous efficacy of  $\sim 60$  Lumens/Watt for a total output of 13440 Lumens or 1,34 Megalux of radiation per/m<sup>2</sup> aperture area (1,34Mlux). The Megalux illuminator depicted projects a high brightness rectangular beam of extreme aspect ratio. Narrow field of view high brightness color controllable linear illuminators have been missing from our armamentarium and markets of interest include machine vision, medical, photography, stage and screen, signage, and retail environments.

LEDs are typically limited in operating power due to thermal constraints as stated in the manufacturer's literature. The increased heat transport rates made possible by integrated thermal management allow LED operation at much higher power levels. Most standard size LEDs can be operated comfortably at 5x continuous rated power levels with proper heat transport. Machine vision LED illuminators are routinely operated at 10x to 20x rated current in short time period pulses. The Megalux illuminator depicted provides heat transport rates and thermal capacitance sufficient to operate the LEDs at much higher than rated power for short periods. Sometimes a single color is operated at high power levels and this is easier to sustain, as the total thermal load on the system may be less than its continuous rated capacity. Operating all of the LEDs at 5x rated continuous power levels, ( $\sim 0,5$  Watt) requires a system power of  $\sim 1\text{kW}$ , a level that can easily be provided with this illuminator for short pulses and 20% percent on time.

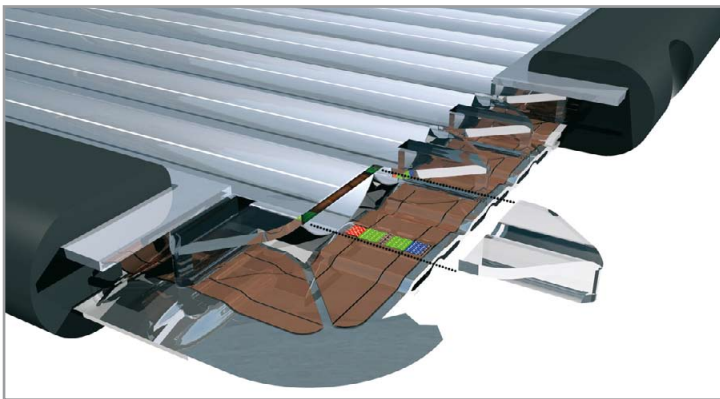

Figure 9: The linear collimated design of the "Megalux"; but it can also be fitted with 2 axis compact cellular collimator arrays for spot rather than line illumination

## Electronics

The value of heat transfer in electronic systems has traditionally been undervalued and underexploited. Integrated thermal management allows LEDs and associated electronics to be placed directly on liquid/vapor cooled heat transfer manifolds via solders or high thermal conductivity adhesives and connected by wire bond to circuitry composed of etched foil/polymer laminates. Aging and temperature are two significant causes of variations in LED visual properties and individual LEDs vary at differing rates. Sensors, lookup tables, and feedback schemes have been developed to reduce the deleterious effects of these changes and it is possible to separately monitor and adjust every color of every LED at every pixel but the cost of this approach is much greater than homogenizing the LEDs and controlling them as a group.

Organizing LED arrays normal to the waveguide edge greatly simplifies the LED electrical circuitry by allowing a parallel array of single layer foil/film traces to provide a wide variety of series and parallel circuits to achieve optimum voltage/current ratios.

## Integrated Thermal Management

The lifetime, efficiency, and power density of LEDs is limited by temperature and the associated means of transferring heat to the local environment. Integrated thermal management (ITM) technology allows densely packed LED arrays and associated power and control electronics to operate at very high power densities while maintaining temperatures consistent with long life and high efficiency. LEDs also vary in spectral composition with temperature and the thermal homogeneity made possible by the manifolding strategies reduces these variations.

ITM encompasses improvements in LED array organization, liquid flow circuitry, and novel micropump arrays within thin section metal manifolds that may be easily integrated into products and systems by replacing elements such as circuit boards and enclosures.

ITM manifolds consist of liquid filled passages operated by Vectored Thermal impulse pumps (VTIPs). The systems are typically operated at sub-atmospheric pressure to allow reduced container wall thickness, simplify manufacturing, reduce phase change temperature, and increase phase change expansion ratios.

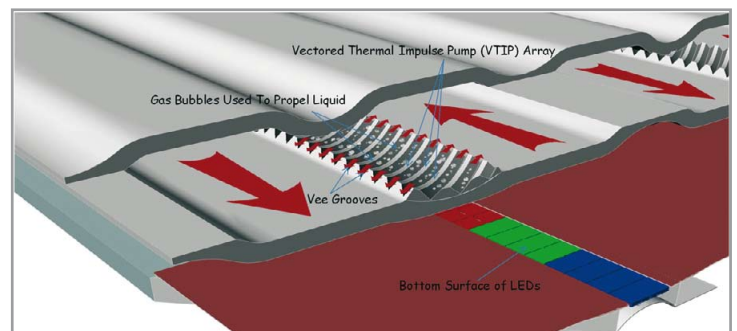

Figure 10: Cross section of an ITM manifold showing the VTIPs

Placing electronic components in closer proximity reduces heating via reduced electron path length and allows increased cyclic rates, but the necessary heat transport circuitry may require longer heat transport path lengths. Integrated thermal management allows the increased heat transport path lengths to be of low resistance and to be accommodated by the use of circuit boards and product enclosures as heat transport circuitry.

### Vectored thermal impulse pumps

Self-heating (Joule heating) is a significant problem in electronic products and systems but the problem may contain the seeds of a solution by using Joule heating to boil liquids and provide pumping forces for forced convection heat transport by the contained liquids.

"Vectored thermal impulse pumps" (VTIPs) cause vapor generated at nucleating sites within cavities to have specific vectors determined by the cavities configuration and orientation. Vapor expanding from the nucleating sites is used to pump liquids by acting as liquid piston pumps within single or multiple exit cavities and by entraining neighboring liquids via viscous shear coupling. The growth in volume accompanying the liquid to gas phase change (boiling) process associated with VTIPs can exceed 10000x depending on the operating pressure within the passages and the operating fluid. VTIPs and related nucleation sites can be created by additive, subtractive, and deformational processes including embossing, coining, knurling, needle punch, and etching.



Figure 11: A circular system consisting of a contra-spiral manifold with VTIPs and ventilation

Electronic heat producing regions can be seen as high temperature reservoirs for steam engines. VTIPs are heat engines and subject to second law limits. VTIPs operating between 350°K and 345°K are subject to a 2<sup>nd</sup> law limiting efficiency of 1,4%:  $(350-345)/350 = 0,014$ . An operating efficiency of 20% of the 2<sup>nd</sup> law limit yields 2,8 watts of mechanical power in a 1000-watt thermal system or ~ 2 ft/lb sec in English units, a considerable pumping effect. The pumps low cost, mass and volume allows arrays of pumps to be placed much closer to localized heat producing regions and causes these regions to act as pumps to propel the neighboring liquid. The pulsatile nature and velocity of the flow allows greatly increased heat transfer coefficients via boundary layer thinning and velocity increase. The pumped liquid transfers heat

via convection to the enclosure surfaces for further communication to the local airstream via natural or forced convection directly or through a metallic extended surface array. The scheme allows the source side of the heat transport system to be greatly reduced in cost, mass, and volume.

### Structure

Illuminator stiffness can be determined by varying local and global curvature, material modulus, waveguide thickness, reflector array depth, and by varying the form and pattern of collimator cell arrays. Linear trough or square cellular reflector arrays allow greater flexibility than close packed circle and hex cells. Parallel "off-axis" linear trough reflector arrays allow the creation of helices and other forms e.g. consider a 10cm width thin film composite illuminator of continuous length with a linear trough reflector array at a 45 degree angle to the edge of the illuminator strip; the illuminator can form a helix with a 45 degree helical angle and can be wound around a post or a box to provide a 360 degree illuminator. Stiff structures are desired for walls, dividers, and for spanning significant distance and may be composed of relatively deep linear troughs or hexagonal cell arrays and may contain an additional planar element spanning the back of and connected to the reflector array to act as a shear panel.

A flexible film illuminator could be composed of a 0,3mm optical grade polycarbonate film waveguide with a printed white dot secondary emitter array on one face and a 0,05mm thick (before thermoforming) aluminized polycarbonate thermoformed film compact cellular collimator array on the opposite face for a total thickness after forming of ~ 0,5mm. Thin film composite illuminators may be cut, punched, bent, rolled, twisted, nailed and otherwise manipulated to provide the desired illumination or effects.

Integrated thermal management enclosures may act as primary or secondary structural elements by replacing circuit boards, interior walls, and exterior surfaces of products.

### Controlled Atmosphere Exchange

Dust accumulation and atmospheric contaminants are common causes of lamp lumen depreciation and electronic system failure. Means to limit the ingress of atmospheric contaminants such as particulates (dust), water, chloride ions, sulfur compounds, insects, and microbes can lead to increase product efficiency and durability. Controlled atmosphere exchange is especially useful in outdoor and extreme climates and in medical environments to reduce microbial transport. If LED luminaires are to survive outdoors, they will have to survive in industrial, marine, urban, and rural atmospheres and with large and sometimes rapid temperature swings.

Controlled atmosphere exchange technology allows the interior spaces of illuminators and electronic product enclosures to be isolated from the local environment except for passage thru a recycling dessicator. The recycling dessicator contains materials such as activated charcoal, silica gel, getters, and biocides to prevent damage from moisture and

contaminant ingress from the local environment and thereby provides protection for internal optical and electronic components. When an illuminator is operating or exposed to sunlight its temperature rise causes expansion of the internal atmosphere and this causes a portion of the contained air to be vented to the local environment thru the recycling dessicator. The clean dry air from the enclosure transports water vapor and organic volatiles from the recycling dessicator back to the local environment. An opposite cycle takes place upon cooling. Upon cooling, air from the local environment enters the illuminator thru the recycling dessicator and its moisture and contaminants are adsorbed by the dessicator media. Proper design can maintain this cycle indefinitely thus provides protection of the illuminator internals in a wide range of indoor and outdoor environments.

The incorporation of a recycling dessicator reduces lumen depreciation and allows increases in lifetime and in the range of operating environments. Additional benefits include a reduced need for electronic encapsulants as bare die and wire bonds should be sufficiently protected with coatings such as Parylenes and simplified rework via encapsulant avoidance.

External airside heat transport systems are much easier to clean than internal air side heat transfer components. Integrated thermal management technology allows illuminator backplanes and enclosures to transfer internally generated heat to the local environment by convection and radiation without the need for internal airflow. ITM also allows closer spacing of electronic components within enclosures and thereby allows more compact electronic systems and shorter electron path lengths.

## Conclusion and Future Perspectives

Saving energy means saving cost, whether in manufacturing, distribution, installation, operation, or maintenance. If the overall cost is higher so is the energy use; cost is a measure of energy. Production rate and process maturity are important factors in the cost of manufactured goods but costs are primarily and fundamentally determined by design. Material mass X cost per unit mass provides a lower cost bound. The radiometric nature of optical systems implies a potential reduction in cost, mass, and volume by dividing the system into a large population of cellular subsystems. Optical, electrical, and thermal homogenization allows LED color composition with greatly reduced LED and electronic system cost. LED illuminators offer much higher value/cost in display, signage, and specialty lighting than in commodity lighting.

Control can play an important role in efficiency. Switchable secondary emitters can improve the efficiency of lighting by directing light where and when desired. A similar degree of control may be exerted for heating purposes. Radiant heating offers fast response and high efficiency by not heating the neighboring thermal mass. Radiant heating with infrared LEDs can bring further increases in efficiency by more localized control and by very low system thermal mass. Infrared LEDs have the lowest manufacturing cost and the highest efficiency.

The technologies presented allow the design and manufacture of semiconductor illuminator systems with improved economy of means and enable the market for these system and allied products to be increased. The manufacturing schemes incorporate existing processes and provide the potential for rapid and widespread implementation. Attractive markets include architecture, art, automobiles, chandeliers, display, fiber optic illuminators, infrared heating, LCD backlighting, medical/health, microscopy, projection, photography, signage, spotlights, stage & screen, and traffic signals.

Enhanced spectrum illuminators will provide radiation from ultraviolet to infrared and will be used for art, optical communication, detection, entertainment, health maintenance, heating, information display, lighting, mood control, tanning, and in some instances from the same illuminator and at the same time. The merger of illumination and display will increase value by increasing efficiency and by providing spatial, spectral, and temporal detection and control. Adaptive lighting and heating will adjust for ambient changes, detect occupants, provide spectral controls for photopic, mesopic, and scotopic visual regimes and allow user control to "suit the mood".

Light valve arrays are not inherently lossy and the losses currently associated with liquid crystal light valves and displays can be mitigated by color sequential operation, compact cellular collimator arrays that focus radiation through unobstructed pixel apertures and by polarizers reduced in absorption or number. Many applications such as lighting and signage do not require the resolution or refresh rates associated with displays and as a consequence can use more efficient liquid crystal light valves and less costly electronics.

Blocking the direct view of high radiance sources is important for many illumination tasks and this was recognized early in the 20th century by Mariano Fortuni who introduced fabric diffusers (lampshades) to hide the garish light from early incandescent lamps.

Radiance is a strong measure of thermodynamic utility and its increase has led to improvements in the economy of sources and of the systems of their inclusion but as the source radiance has increased so has the need to restrict direct view. At some point eye safety also becomes an issue. The radiance of LEDs will increase greatly in the next several years and the designer's task will increasingly be appropriate reduction of illuminator radiance. ■

# Thermal Management

## Ceramic Simplifies Heat Dissipation

> Dr. Armin Veitl, Dir. of Design – Europe, Altair Engineering GmbH

LEDs suffer heat problems limiting their success as a light source. Much attention is given to the heatsink, less to the layers and barriers between LED and the heat dissipating surface. A change of concept and material allows significant gains in thermal management and reliability as well as a simplified system. Using ceramics as heatsink, circuit carrier and part of the product design needs some fresh thinking and the willingness to overcome traditional patterns. A simulation method based on Computational Fluid Dynamics supports thermal optimization and technical product design. Besides the theoretical approach, the proof of concept shows what and how improvements with ceramic heatsinks can be achieved.

### The Impact of Heat

LEDs are known to be efficient and are loved for being tiny. But they are only really tiny as long as heat management is not involved. Incandescent light sources work with temperatures up to 2.500°C. LEDs are much colder and many people stumble upon the fact that heat is such an issue. Being relatively cold LEDs still do produce heat which is not yet a problem. But they are based on semiconductors which, roughly speaking, simply allow temperatures below 100°C. According to the law of energy

conservation the thermal energy must be transferred to the surrounding area. The LED can only use a small temperature gap between 100°C of the hot spot and 25°C ambience temperature; offering just 75 Kelvin. Consequently a larger surface and powerful thermal management are needed.

### Two Optimization Blocks

Group 1 is the LED itself and mainly remains untouched. Its centre is a die and a heat slug, a copper part, which connects the die with the bottom of the LED. Thermally, the ideal solution is direct bonding of the die to the heatsink itself. Due to mass production this concept is commercially unrealistic. Hence, the LED has to be considered as a standardized "catalogue" product which can not be modified. It is a black box.

Group 2 is the heatsink, transmitting energy from a heat source to a heat drain. This is usually the surrounding air either with free or forced convection. The less aesthetic the material, the higher is the need to hide it. The more you hide it the less efficient is the cooling. Alternatively, pleasing and worthy materials can be used, directly exposed to the air and being part of the visible product design.

In-between group one and two is Group 3 providing mechanical connection, electrical isolation and thermal transmittance. That seems contradictory since most materials with good thermal conductivity conduct as well electricity. Vice versa almost every electrical isolation material translates into a thermal barrier. The best compromise is soldering the LED to a PCB which is glued on the metal heatsink. The original function of a PCB as a circuit board can be kept. Although PCBs exist with various thermal conductivities they remain an obstacle to thermal transfer.

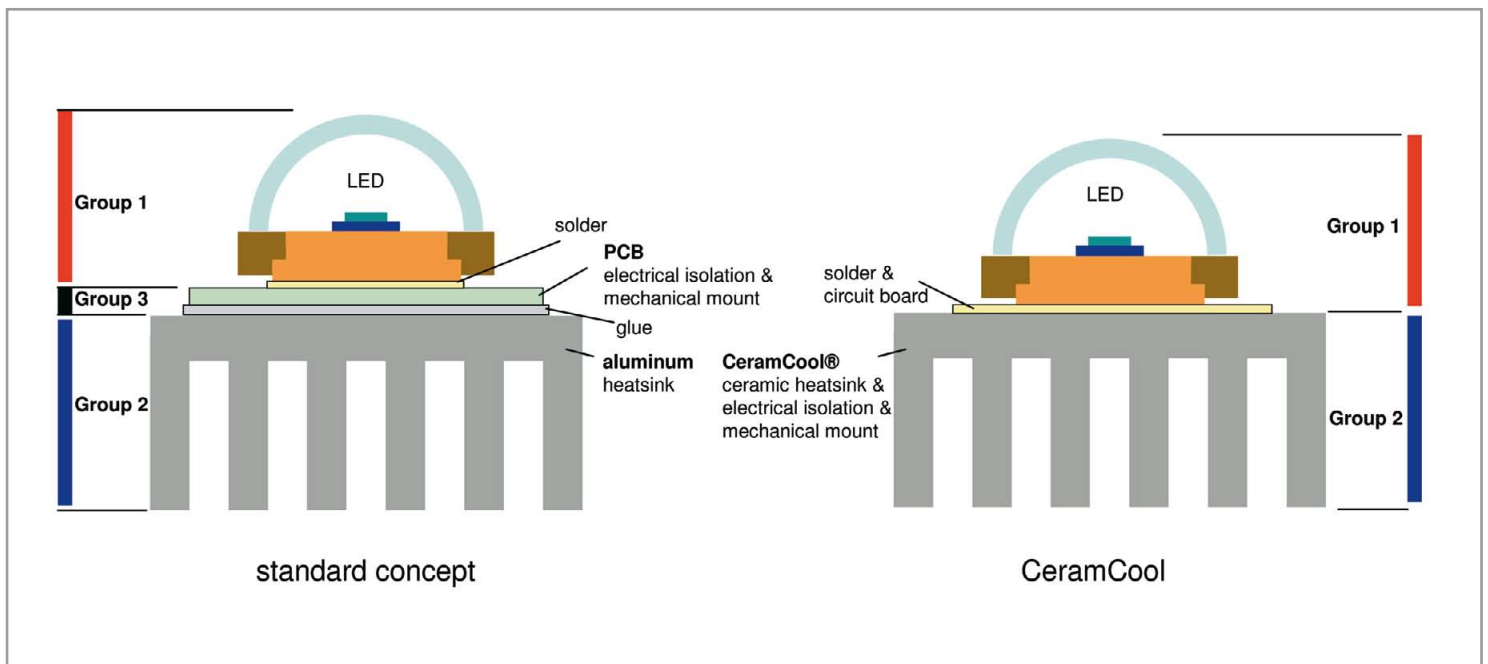

Figure 1: Three groups build a thermal management system and are examined for optimization potential

## $R_{tt}$ for Valid System Comparison

The thermal resistance of LEDs (die to heat slug pad) and heatsinks is available from the manufacturer. But there is little focus on group 3 and its significant influence on the total thermal performance.

Adding all thermal resistances but the LED (group 1), the total thermal resistance  $R_{tt}$  is born. The  $R_{tt}$  allows a real comparison of heat management concepts.

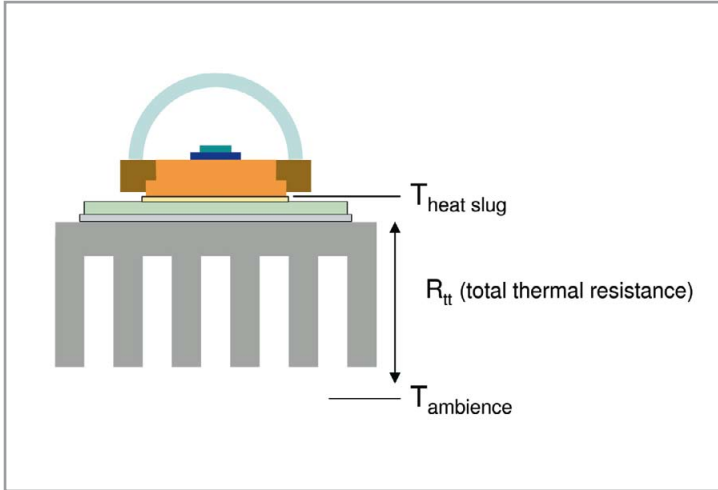

Figure 2:  $R_{tt} = (T_{\text{heat slug}} - T_{\text{ambience}}) / \text{heat emission LED}$

$R_{tt}$  indicates the total thermal resistance from the LEDs headslug to the surrounding. The comprehensive factor simplifies the comparisons of cooling systems and their efficiency.

## Ceramic: Two Jobs in One Material

It is common to optimize only the heatsink. Hundreds of designs are available, essentially of aluminum. But for further improvement it is necessary to advance or even eliminate the third group. Electrical isolation has to come from the heatsink itself by the use of other materials. One solution is ceramic. Ceramics, e.g. Rubalit ( $\text{Al}_2\text{O}_3$ ) or Alunit ( $\text{AlN}$ ), combine two crucial characteristics: They are electrically isolating and thermally conductive.

Rubalit has a lower, Alunit a slightly higher conductivity than aluminum. On the other hand Rubalit is less expensive than Alunit. Their thermal expansion coefficient is adapted to semiconductors, they are rigid, corrosion-resistant and RoHs compliant. Completely inert, they are the last part of a system to die. The simplified construction (without glues, insulation layers, etc.) combined with a direct and permanent bond between the high-power LED and the ceramic heatsink create ideal operating conditions for the entire assembly. Put simply: What isn't there won't wear out and materials that expand in proportion to each other won't separate. The result is excellent long-term stability, secure thermal management and exceptional reliability.

## The Theory

The ceramic heatsink CeramCool is an effective combination of circuit board and heatsink for the reliable cooling of thermally sensitive components and circuits. It enables the direct and permanent connection of components. Also, ceramic is electrically insulating per se and can provide bonding surfaces by using metallization pads. Customer-specific conductor track structures can be provided, if required even three-dimensional. For power electronic applications direct copper bonding is possible. The heatsink becomes a module substrate that can be densely populated with LEDs and other components. It quickly dissipates the generated heat without creating any barriers.

## Validation and Proof of Concept

The idea to use ceramics was first cross-checked in several simulation models. To predict thermal behaviour of various designs a method based on Computational Fluid Dynamics (CFD) was developed. Equally an optimized ceramic heatsink for 4W cooling was developed. Manufacturing requirements were taken into account. The optimized geometry allows operation of a 4W LED at a maximum temperature below  $60^\circ\text{C}$  which was validated against physical tests. The design is square in shape (38mm x 38mm x 24mm) and comprises longer, thinner fins with a larger spacing. The identical geometry in aluminum with a PCB mounted LED showed significant higher temperatures. Depending on the thermal conductivity of the PCB (from  $\lambda = 4\text{W/mK}$  to  $1,5\text{W/mK}$ ) the temperature rose between 6K to 28K.

Already a 6K reduction at the hot-spot implies significantly less stress for the LED. The total thermal resistance of the Rubalit assembly is at least 13% better than aluminum with identical shape. Using Alunit the minimum improvement of CeramCool reaches 31%. These good results are outperformed largely for both ceramics if the heat drop of 28K is taken into account.



Figure 3: First serial production of optimized CeramCool geometry for 4W cooling. With Rubalit the total thermal resistance  $R_{tt}$  of the assembly is at least 13% better than aluminum. Using Alunit it is more than 31% better.



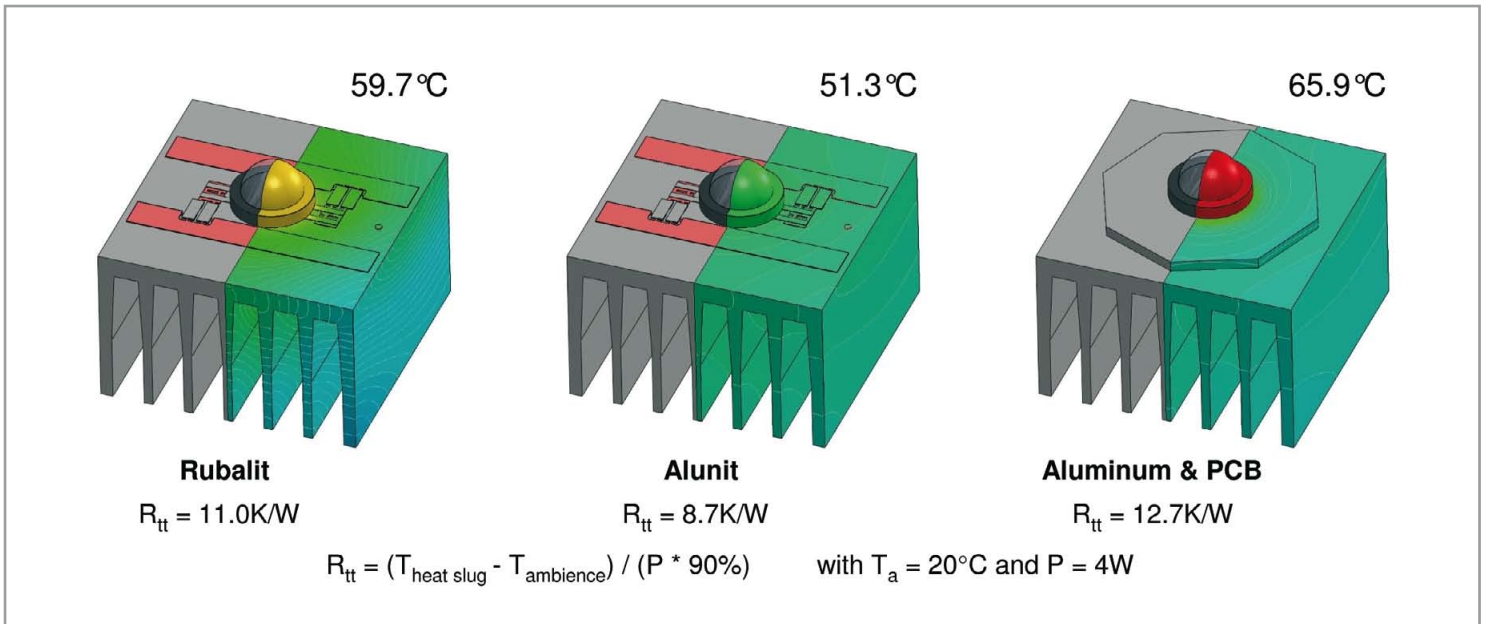

Figure 4: For validation purposes a simulation model has been developed. All results were verified by product samples

### Flexibility of Concept

The concept is flexible and can be used for different targets. It's the designers choice whether he runs a LED on its optimum temperature assuring high life time and high lumen per Watt or he accepts higher temperatures reducing life time and efficiency. A temperature spread from 50°C to 110°C is common. If more lumens are needed the 4W-heatsink can be equipped with 5W or 6W LEDs. Splitting the power into several 1W LEDs helps to get a better heat spreading. The results are 65°C with 5W and 70°C with 6W.

### Smaller Sizes

With the chip permanently and reliably bonded to the electrically insulating CeramCool, the heatsink takes more heat and becomes hotter. It takes the burden off the LED and does exactly what it is made to do, namely, cool the critical components. The reduced die temperature allows a downsized surface, a smaller heatsink. Its higher temperature makes it possible.

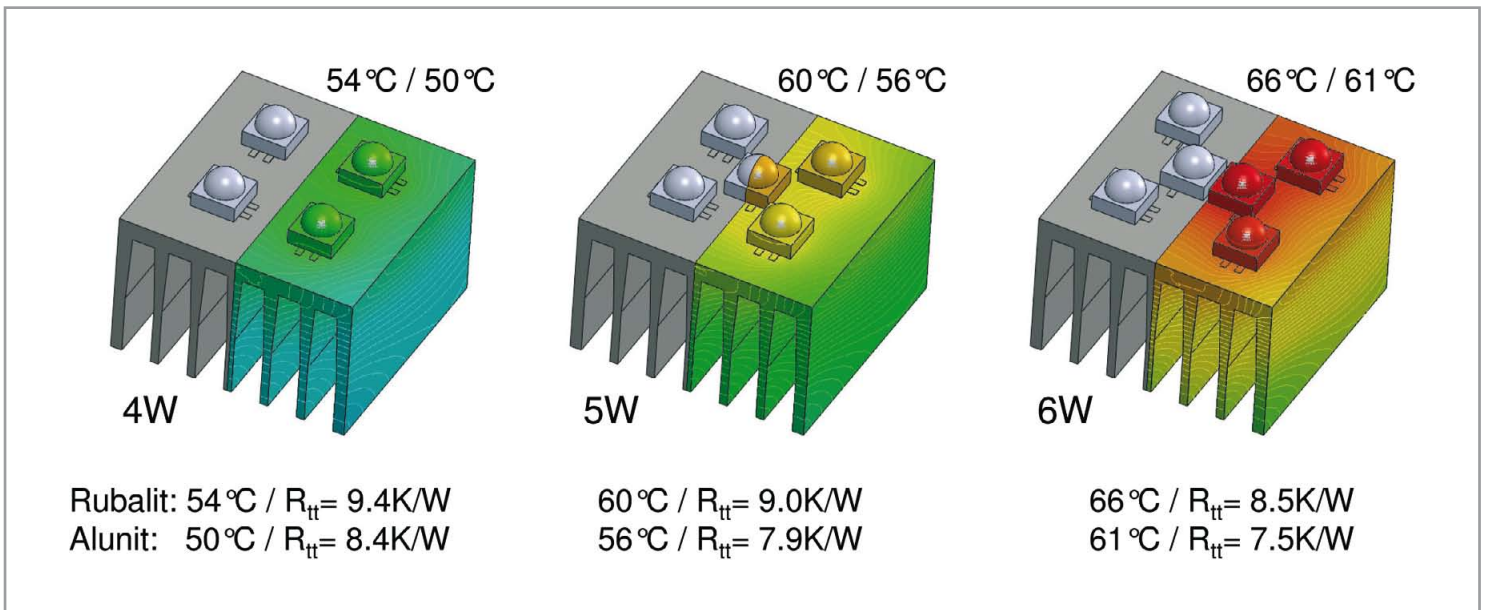

Figure 5: Splitting the power for better heat spreading offers new prospects

## Cooling Water at 2mm Distance

Air cooling reaches its limits at very high power densities. This is where liquid cooling is best suited. One example is CeramCool water cooling which benefits from the inertness of ceramics. No corrosion can cause trouble. The concept follows the same goal as for air cooled heatsinks: Shortest (thermal) distance between heat source and heat drain. With ceramic it is feasible that cooling water is only 2mm away from the LED heat slug. No other concept can do this in combination with the durable nature of ceramics. Multilateral electrical circuits can be printed directly on the ceramic without creating thermal barriers.

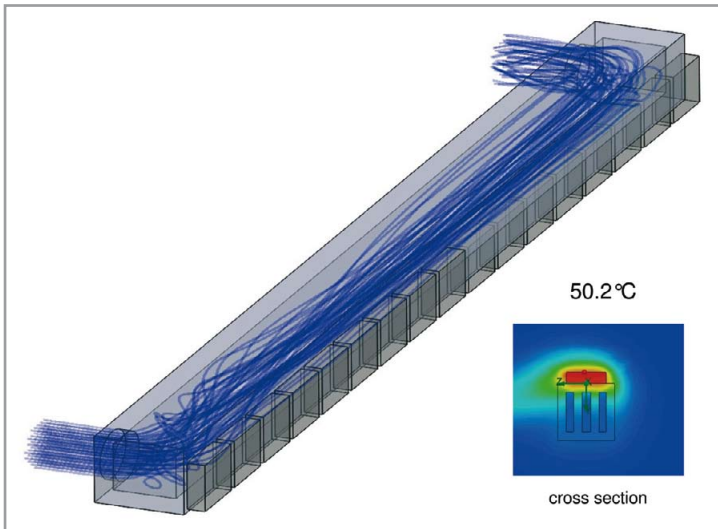

Figure 6: CeramCool liquid cooling allows almost any needed cooling capacity. Here the power density of 290W is managed with only 120mm lengths. The cooling water is only 2mm away from the LED heat slug

## Simulation Models for Customized Solutions

Since most of the applications where CeramCool is used are customer specific solutions, it is essential that the performance can be proved before first expensive prototypes are made. Intensive studies were made to build up simulation models. These simulation models have been verified against various tests and showed reliable correlations to test results. Based on this knowledge, new concepts or variations are easily evaluated. What is the thermal advantage of splitting a 5W LED into 5 LEDs of 1W? What is the benefit of a heat spreader included in the circuit layout?

## Retrofit Lamps and Isolation

The problem of retrofit lamps is mainly one of isolation. Any retrofit lamp has to be class II construction because you cannot guarantee an electrical earth. This means that any exposed metal part has to be isolated from the mains wiring by double or reinforced insulation. Often retrofits with metal heatsinks do not comply as it requires larger distances (like 6mm in air) or double layers of insulation which stop the heatsink working well. The integrated electronic driver in a GU10 LED is so restricted for space that this is a very difficult product. With a ceramic heatsink even if the driver fails completely mains electricity is not conducted by the heatsink and the product is safe.

E.g. the new CeramCool GU10 LED spot works with any LED. Socket and reflector are made from a single material: a high-performance ceramic. Thus it is a simple class II construction with safe insulation. A high voltage 4W LED only reaches a maximum temperature below 60°C, so both lifetime and light output are increased. In all CeramCool ceramic heatsinks the substrate becomes the heatsink. Here it acts as the lamp, or even the luminaire. The simplified design delivers extremely high reliability. In addition, the mount and reflector of GU10 LED spots are usually made of different materials. With this solution far fewer materials are used and ceramics are exploited for their electrical insulation, good EMC and high mechanical and chemical stability. Last but not least: The indirect light and the continuous ceramic construction are beautiful.



Figure 7: The CeramCool GU10 LED spot has a fully ceramic construction. Takes any LED. Simple class II construction with safe insulation. Designs are developed in consultation with customers



Figure 8: CeramCool GU10 LED spot: only lamp or even luminaire? Indirect light and continuous ceramic construction delight the eye

## Conclusion

As shown, the newly developed ceramic materials, perform very well and have numerous advantages over conventional design and materials. Also other high power applications, especially for outdoor usage, gain as well from the features of these ceramics. It is still an unusual material for heatsinks but as simulation models and physical tests have shown the electrical isolating and heat transmitting character enables a simplified and more powerful heat management design. ■

# Guangzhou International Lighting Exhibition 广州国际照明展览会

The biggest lighting industry  
forum in Asia

**9 – 12 June 2009**

**China Import and Export Fair Pazhou Complex  
Guangzhou, China**

**Show highlights:**

- Asia's largest lighting exhibition and the 2nd largest in the world
- Over 1,500 exhibitors and 48,000 expected visitors
- Over 100,000 gross sqm exhibition space
- Dozens of symposiums featuring global speakers

**For free admission, register online now at**

[www.light-building.messefrankfurt.com](http://www.light-building.messefrankfurt.com) and click on  
Guangzhou International Lighting Exhibition

**For information, please contact:**

Tel +852 2238 9964

Fax +852 2598 8771

[LBguangzhou@hongkong.messefrankfurt.com](mailto:LBguangzhou@hongkong.messefrankfurt.com)

[www.light-building.messefrankfurt.com](http://www.light-building.messefrankfurt.com)



messe frankfurt

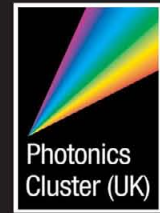

# euroLED

2009

Europe's Leading  
Conference, Exhibition & Gala Dinner  
in Solid State Lighting

Ricoh Arena, Coventry  
3rd & 4th June, 2009

Visit the recently launched 2009 euroLED website:  
[www.euroLED.org.uk](http://www.euroLED.org.uk)

Premier Sponsors:

**anglia** lighting

 **EBV** Elektronik  
| An Avnet Company |

 **FUTURE**  
Lighting Solutions  
Making LED Lighting Solutions Simple

 **MARL**

**OSRAM**  
Opto Semiconductors

Other Event Sponsors:

 **MOW**

 **Advantage**  
West Midlands  
www.advantagemw.co.uk

 **SEOUL**