

LED Applications & Lighting Systems

LEDs & OLEDs
in General Lighting Applications

LEDs in Shop Lighting - Interview

Evolution of LEDs

High Quality GaN Substrates

Show & Product Previews

2010
light & building

Go Deeper

Offering the deepest dimmable control for LED lighting solutions, NXP and Future Lighting Solutions give you the power to never stop innovating.

NXP's SSL Driver Solutions are designed to provide deep dimming completely flicker free with a natural dim curve. Its isolated voltage circuitry accelerates UL approval, thus speeding your time to market.

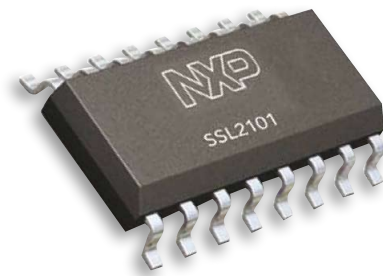

Visit www.FutureLightingSolutions.com now, for instant access to the NXP Future Lighting Solutions virtual catalog and the best technical expertise in the industry.

Zhaga Pushes Standardization



The new consortium for the standardization of LED light engines was named after the Zhaga waterfalls in the Munigou Scenic Nature Reserve in China. Like the cascading water that takes various routes and ends up in one main stream, the Zhaga consortium was established to make LED developments manageable for luminaire manufacturers all over the world. The initiators are convinced that further growth in the general illumination market can only be achieved by defining stable design platforms for luminaire manufacturers based on interface standards for LED light engines. This would prevent fragmentation into a large number of incompatible light engines, enabling a second source supply of LED light engines which would stimulate market growth by fostering competition.

Standardization is focused on defining the mechanical, thermal, electrical and photometric interfaces of an LED light engine which would allow manufacturers to implement a Zhaga certified product for many years without hindering further improvements of the light engine internals. A weak point of the Zhaga goals seems to be that they neglected to harmonize the interface between the LED driver and the light engine - especially when the drivers are not integrated in the light engine itself.

Even if Zhaga focuses on interfaces, the process is complex and it will be necessary to develop a group of standards for interchangeable and interoperable light engines covering different applications as well as types of light engines. A minimum set of common standards should cover products which are already on the market and standards which are already established.

Zhaga is an open, global consortium which at the moment is made up of 24 regular members, who are, for the most part industry players. These members will define an industry standard first and then offer it to an international standardization committee like IEC. In the same way that the Chinese waterfall continuously supplies water without directives, the lighting market will overflow with disharmonized LED products in the near future. "Time is therefore crucial for the Zhaga members" stated a spokesperson of the consortium and I would add, for the entire market as well.

Finally, it is important to mention that Zhaga will grant royalty-free licenses for all patents that are necessary to implement the interface standards developed by the consortium. The consortium spokesperson said that they are aware of the fact that standardization and innovation, especially in a new technology field like LEDs, has to be balanced. The first meeting of the General Assembly met on March 2nd and the working groups will meet every 6 weeks starting on April 15th.

LED professional wishes the Zhaga consortium the best of luck. We will be giving our readers background information on a continuous basis and reporting the outcomes of this standardization initiative.

We would very much appreciate your feedback about *LpR*. Let us know what you like or tell us how we can improve our services. Please keep in mind that you are also welcome to contribute your own editorials.

Yours Sincerely,

A handwritten signature in blue ink, appearing to read 'Siegfried Luger', written over a horizontal line.

Siegfried Luger

Publisher

Imprint

LED professional Review (LpR)

ISSN 1993-890X

Publisher

Luger Research e.U.
Institute for Innovation & Technology
dep LED professional
Faerbergasse 15, Haus Rot
A 6850 Dornbirn, Austria / Europe
phone +43 5572 394 489
fax +43 5572 394 489 90
editors@led-professional.com
www.led-professional.com

Publishing Editors

Siegfried Luger
Arno Grabher-Meyer

Account Manager

Theresa Koenig

Promotion Manager

Silvia Girardelli

Front-page picture

Artwork: Thomas Klobassa, ©LED professional 2010

Copyrights – Luger Research e.U.

The editors make every reasonable effort to verify the information published, but Luger Research e.U. assumes no responsibility for the validity of any manufacturers, non profit organisations or individuals claims or statements. Luger Research e.U. does not assume and hereby disclaims any liability to any person for any loss or damage caused by errors or omissions in the material contained herein, regardless of whether such errors result from negligence, accident or any other cause whatsoever. You may not copy, reproduce, republish, download, post, broadcast, transmit, make available to the public, or otherwise use *LED professional Review (LpR)* content without prior written consent from Luger Research e.U. – Institute for Innovation & Technology, Austria. ■



LED professional Review (LpR) – Annual Subscriptions

LpR Digital Magazine

- 6 issues
- pdf download
- high resolution pictures and graphs
- printable
- commercial use
- access to all previous issues
- Euro 78.80
- <http://www.led-professional.com/subscription>

LpR Printed Magazine

- 6 issues
- Euro 158.40

Next LpR Issue – May/June 2010

- LED Light Generation

Content

Editorial	p1
Imprint	p2
Project News	p5
Product News	p5
Research News	p5
Event News	p16

■ Applications

LED in General Lighting Applications

by Günther Sejkora, items – Innovation and Technology Management p24

LEDs For Shop Lighting: Interview with lighting designer Simone Mariotto

by Arno Grabher-Meyer, LED professional p28

Addressing the Rising Requirements for Solid State Lighting Products

by Mitch Sayers, Cree Europe GmbH p32

OLED Technology – Status of a Promising Lighting Solution

by Siegfried Luger, LED professional p36

LED Retrofits for Antique Style Roadway and Walkway Lights

by Heather Goldsmith, Future Lighting Solutions p40

■ Technology

High Quality GaN Substrates for Modern LED Technology

by A.E. Romanov, et al., CJSC "Optogan" / Ioffe Physical-Technical Institute RAS p42

■ Thermal Management

LED – Cooling and Thermal Management

by Lothar Noelle, Fischer Elektronik p50

■ Drivers

Intelligent LED Driver/Controllers Becoming Standard Modules

by Albert Berghuis, eldoLED p56

LED professional – Patent Report	p60
-----------------------------------------	-----

Advertising Index

FUTURE LIGHTING SOLUTIONS	p C2
EVERLIGHT	p 4
MINLEON	p 7
CITIZEN	p 11
INSTRUMENT SYSTEMS	p 15
SIGNCOMPLEX	p 17
KINGBRIGHT	p 18
LEDIL OY	p 19
OSRAM	p 23
ALPHA-ONE ELECTRONICS	p 27
AVAGO	p 29
STELLARNET	p 31
CREE	p 33
RAGNI SAS	p 37
OCEAN OPTICS	p 39
GOSOLED LIGHTING	p 41
SEOUL SEMICONDUCTOR	p 43
LUMIVILLE	p 45
LIGHTING JAPAN	p 47
LED LIGHTING TAIWAN	p 49
BERGQUIST	p 51
LED LIGHT FOR YOU	p 53
EUROLED	p 55
GZ-INT. LIGHTING EXHIBITION	p 57
VOSSLOH-SCHWABE	p 59
LOK-F GMBH	p C3
TRIDONIC.ATCO	p C4

there is not only
off & on
there is Everlight



MR16



Office Lighting



Streetlight



High Power



SMD LED



Power LED



LED LAMPs



IR Devices



Digital Display



Photo Coupler

Project News

Philips Dyalite Provides Green Lights for Scarlet Hotel

Leading lighting control and automation group, Philips Dyalite, has drawn on its expertise in the hospitality sector to supply an energy-saving lighting control system for the luxury Scarlet eco-hotel in Cornwall. The design by Philips Dyalite Dimension dealer, Lightmaster-Direct, embraces best environmental practices to yield a lighting scheme in harmony with the surroundings - using just 3.4 watts per square meter - and providing guests with an unparalleled ambience and sense of opulence.



The luxury Scarlet eco-hotel employs an energy-saving lighting control system from Philips Dyalite, including a garden lighting design using less than 100 watts in total (top). Stunning architectural and mood lighting belie the considerable energy savings realized—with an internal lighting efficacy of just 3.4 watts per square meter being achieved (down).

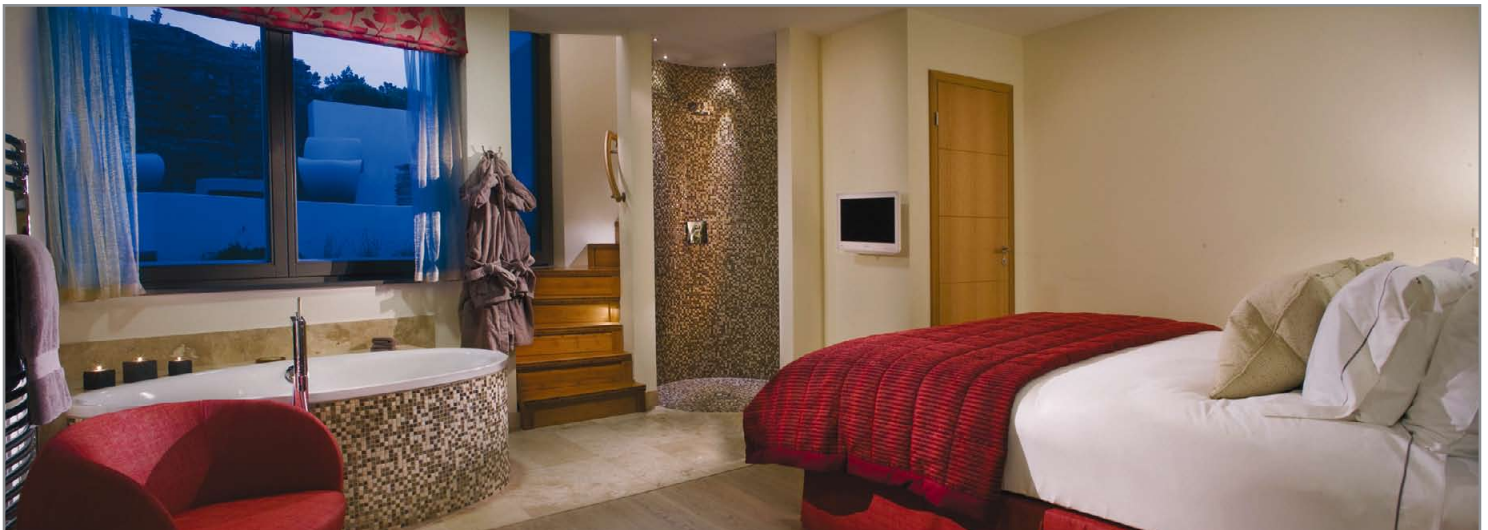

Guests can match their mood from a choice of seven lighting scenes, carefully created by the design team to enhance the ambience of the guest rooms.

According to the Development Director for the Scarlet Hotel, Simon Baldwin, the lighting system reflects the pioneering approach to environmental sustainability that is the hallmark of the hotel's design. "The Scarlet has been designed to maximise the use of natural light as much as possible, and this has driven the development of the lighting system itself."

"All the lighting is either fluorescent or LED, and the Scarlet is probably unique in this respect," said Baldwin. "The design is also challenging the expectation that hotel lights need to be on all the time, making extensive use of multipurpose sensors to ensure lights are turned off when not required."

Lightmaster-Direct designed, engineered and commissioned the innovative lighting system to meet stringent environmental, functional and architectural criteria. Integral to the overall design, many of the hotel's light fittings were custom-designed and built by Lightmaster-Direct to meet these exacting standards.

"The design brief called for an integrated lighting control system to provide pre-set lighting scenes in all public areas and mood lighting to bedrooms - all controlled by a combination of wall-controls, remote controls and motion sensors," said Lightmaster Design Director, Richard Nock.

Two Philips Dyalite touch-screen control panels allow the lighting moods of the public areas to be set by the hotel staff. Revolution 2 user-interface wall panels permit local user control for some public areas and all the guest rooms. There are two engraved and backlit Revolution 2 wall panels in each guest room - one by the entrance and one by the bed - and these have been designed to be intuitive and simple to operate. Guests can match their mood from a choice of seven lighting scenes carefully created by the design team - 'ambient', 'bright', 'relax', 'bath', 'night', 'balcony', and 'all off'.

In spite of the architectural and mood lighting results achieved, considerable energy savings have been realized. "Where a conventional hotel typically achieves lighting efficacy of 10 watts per square meter, the finished system achieved a staggering internal lighting efficacy of just 3.4 watts per square meter - representing just 34% of the energy use of a conventional design. ■

Product News

Nexxus Lighting: Commercially-Available QD- LED Replacement Light Bulbs

Nexxus Lighting, Inc. has begun production and shipment of its new Array™Quantum LED R30 replacement light bulb. Developed in conjunction with QD Vision, this is the first commercially available LED lamp that utilizes quantum dots to deliver true 2700° Kelvin, high-color rendering (91 CRI) incandescent warm white light at an industry leading 60 lumens per watt.



The Nexxus LED Array™ PAR lamp.

"After announcing this project in 2009, it is very exciting to see our vision come to life with the product finally flowing down the assembly line and into the marketplace," said Mike Bauer, president and CEO of Nexxus Lighting, Inc. "In collaboration with QD Vision, we have developed a product that trumps competitors who are offering high CRI, but very low lumens per watt and set a new industry standard.

The new Array™Quantum LED R30 features the new co-developed Quantum Light™ Optic from QD Vision and unique LED package from Citizen Electronics combined with Nexxus' patented and patent pending design and Selective Heat Sink™ thermal management system. Array™Quantum LED R30 will deliver the highest efficiency 90+ CRI system currently available on the market.

"Our Quantum Light™ Optic is the first product that allows manufacturers to make warmer-colored, high-efficiency LED lamps, which is seen as essential to their widespread adoption," said Dr. Dan Button, QD Vision President and CEO. "This new lamp from Nexxus Lighting demonstrates the value of Quantum Dots for solid state lighting applications."

The new Array Quantum LED R30 lamps will be featured at the upcoming Global Shop trade show at the Sands Expo and Convention Center, March 10th-12th in Las Vegas, Nevada. Nexxus Lighting's booth number is 1628. Representatives from both Nexxus and QD Vision will be on hand to demonstrate the product. ■

New LED-Based Edge Lighting Solutions from GLT

Global Lighting Technologies (GLT), Inc., developer of the world's most efficient LED-based display backlights, is continuing its technological progress with a new range of LED-based edge-lit illumination solutions to expand its offerings beyond LCDs, keyboards and keypads and into areas of egress lighting and general illumination.

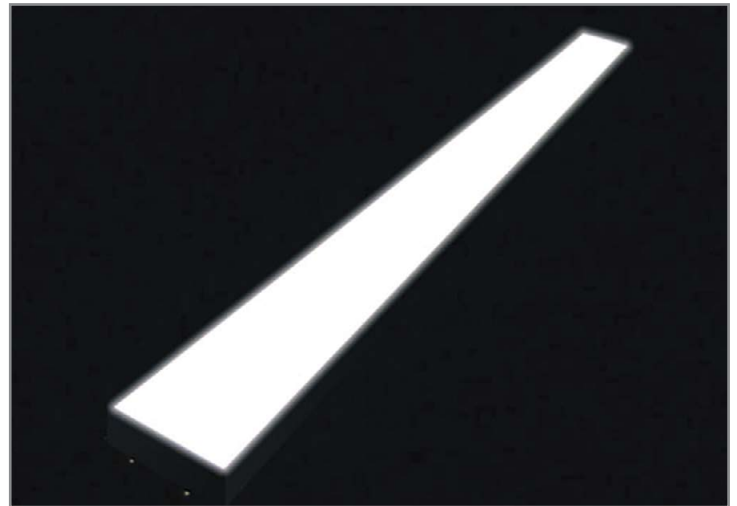

GLT expands their edge-lighting technology to general lighting products.

"Edge-lit LED illumination has moved well beyond its established turf in backlighting portable and handheld product displays, and so has GLT," said VP & General Manager David DeAgazio, referring to the company's long-established success in super-efficient, ultra-thin BLU (backlighting unit) designs for a wide range of backlit displays.

GLT is enhancing the advantages of LED illumination with a new range of edge-lighting solutions utilizing high efficiency LEDs that focus the light into a high-performance backlight, or light guide. Because the LEDs are located on the edge of the light guide, there is better optical control for color and uniformity, fewer LEDs, better repeatability, and the thinnest possible lighting solution.

"GLT is leveraging its history of high efficiency edge-lit LED light guides to expand beyond LCD and keyboard backlights, though they remain important market segments for us," said Director of Sales and Marketing, Brett Shriver. "New solutions include edge-lit backlighting units for exit signs and all manner of egress lighting. GLT has also entered into the general illumination/solid state lighting market with new edge-lit illumination for downlights such as task lights and troffers."

"If it can be edge lit," said Shriver, "GLT can provide the best illumination solution." These new illumination solutions from GLT include edge-illuminated LED backlight panels for egress lighting and exit signs, downlighting, as well as under-cabinet, splash, desk task lighting, refrigeration, and cabinet illumination solutions.

GLT continues to provide BLUs for LCDs, keyboards and keypads utilizing the most efficient LED-based edge lighting and the slimmest BLUs available for maximum brightness with optimum uniformity, superior color mixing and a smaller number of widely spaced, high-output LEDs with low-cost manufacturing and quick turnaround. ■

Osram Unveils LED Module for Street Lighting

With Streetlight Advanced, OSRAM provides an efficient and future-proof solution for technical and decorative street lighting with LED. This durable module enables lighting without distracting stray light plus easy maintenance thanks to a lamp socket that is installed once only. In addition to that, the module is sustainable due to its standardized, consistent system interfaces as well as unchanging dimensions.

Compared with the mercury-arc lamps still widely used in street lighting, the Streetlight Advanced LED module saves a third of the energy. With a light yield of up to 60 lm/W, Streetlight Advanced enables sustainable lighting.

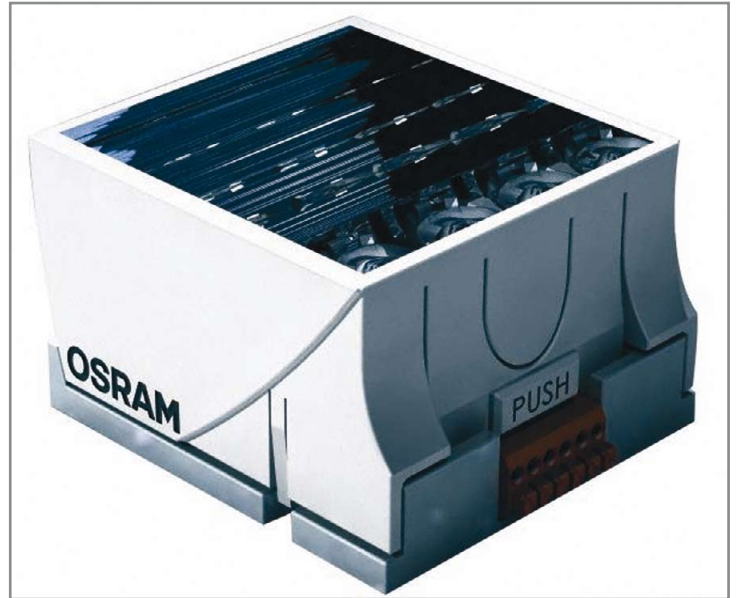

Streetlight Advanced LED module and further LED highlights will be on display at the OSRAM Light + Building trade fair stand in Hall 2.0, Stand B 50.

The module itself comprises an LED, lens and reflector. An additional lamp socket is installed once only in the luminaire housing. Should even more efficient LEDs become available in future, the new modules can simply be snapped onto the existing socket without tools. The luminaire does not have to be replaced or modified, as the dimensions of any Streetlight Advanced LED modules developed by OSRAM will remain unchanged.



MinleonTM

A Leading Manufacturer & Distributor of Quality Holiday, Decor & General Use LED replacement Bulbs and String lights

LED professional

LED Ceiling Panel



www.minleon.com

Minleon International is a leading manufacturer of high quality LED lighting products. Featured products include retrofit/replacement LED bulbs in the holiday, décor and general use markets. Minleon has an in-house professional design team for tooling, custom plastic molding, SMD and assembly. Minleon has a branch facility in the USA to warehouse product and provide hands-on customer service to its nationwide network of distributors and their customers.

LED lamps



www.minleon.com

Minleon International Ltd.
Dongken Town, Dongken City
Guangdong Prov, China 523450
website: www.minleon.com
email: info@minleon.com

www.minleon.com

Minleon International USA Ltd.
3920 Market Street
Camp Hill, PA 17011
Toll-free 866-670-0422
email: minleonusa@live.com

The streetlamps' brightness can be individually adjusted, depending on the number of LED modules used. Plus, the modules can be perfectly controlled and dimmed using the appropriate Optotronic power supply and control gear.

With the modules' high color rendering index of 75-80, illuminated objects appear very natural without any color distortion. Streetlight Advanced is available either at a color temperature of 6,000 K or warm white at 3,000 K.

The module's extremely long life of up to 50,000 hours in a luminaire with a suitable heat sink reduces maintenance costs. As modules can be replaced without tools, the Streetlight Advanced module offers key benefits with simple and fast maintenance.

Apart from their efficacy and long life time, the fundamental benefits of LED in street lighting are their directed light, i.e. the LED only emits light in the desired direction or on the desired surface. The Streetlight Advanced module's particular optical concept – comprising LED, lens and reflector – enables a very high optical efficacy plus a street lighting according to the DIN EN 13 201 standard with very uniform and sharply defined illumination.

As such, despite its lower power input, an LED street lamp achieves brighter and more uniform illumination of a defined surface. This enables the road to be illuminated ideally and in conformity with standards without scattered light and adherence to glare limitations. ■

PrevaLED: Creative Freedom for Luminaire Designers

Flexibility, great freedom of design and high efficiency – these are the main advantages of the new PrevaLED Core Light Engines by OSRAM. The PrevaLED range is designed using a modular principle and thanks to fixed interfaces reduces both development effort and time to market for luminaire developments. The system consisting of light engine and electronics control gear is small, easy to use and extremely powerful.

PrevaLED light engines enable luminaire manufacturers - despite the fast development cycle of LED - to significantly reduce the effort of developing new luminaires and thus to save costs. Design ideas can be evaluated and realized much quicker.

The PrevaLED Core product family provides a wide range of lumen output options from 800 lm to 3,000 lm at a system efficiency of up to 75 lm/W and is available in the color temperatures 3,000 K and 4,000 K. A special feature of this system is its outstanding light quality with a color rendering index (CRI) >90, without compromises in system efficiency. Active control of the light engines reduces the tolerances between single light engines below the limit of visual perception.

Thanks to intelligent system design, currently available lumen packages will be available for years, independent of increased LED efficiency, thus permitting a future-proof luminaire design.



With PrevaLED, OSRAM provides an efficient and future-proof platform for LED illumination. The system consisting of light engine and electronic control gear (ECG) is small, easy to use and powerful.

Individual Future-Proof Luminaire Design:

Irrespective of the lumen output, all round modules have the same dimensions (50 mm diameter) and feature the same integrated reflector mounting options. Thanks to the wide beam angle of 140° these light engines are ideally suited for light shaping with reflectors. The light engines can be flexibly combined with various control gears allowing the simple integration of additional functions such as dimming, if so required. The combination of these features and their compact size make PrevaLED Core light engines ideally suited for use in downlights and spots of various output powers. ■

Sharp MiniZeni: Small, Flat, Bright and Cost-Effective

Sharp has developed a new series of high-power LEDs. The six new models of the "MiniZeni" series, which is the young daughter of the Zenigata series, represent yet another addition to the Sharp LED portfolio. The future-orientated product variants are characterised by four special features: they have compact outer dimensions and are extremely flat, economical and bright. Sharp "MiniZeni" LED modules are substantially smaller than the models of the ZENIGATA LED modules; with dimensions of 15x12x1.6 mm, they only require 56% of the volume of their parent with approximately the same light output. A ceramic plate is also used as the carrier material. With a light output of up to 410 lm (depending on the module), a substantially improved CRI value of at least 87 at all color temperatures, Sharp sets new standards in light technology.

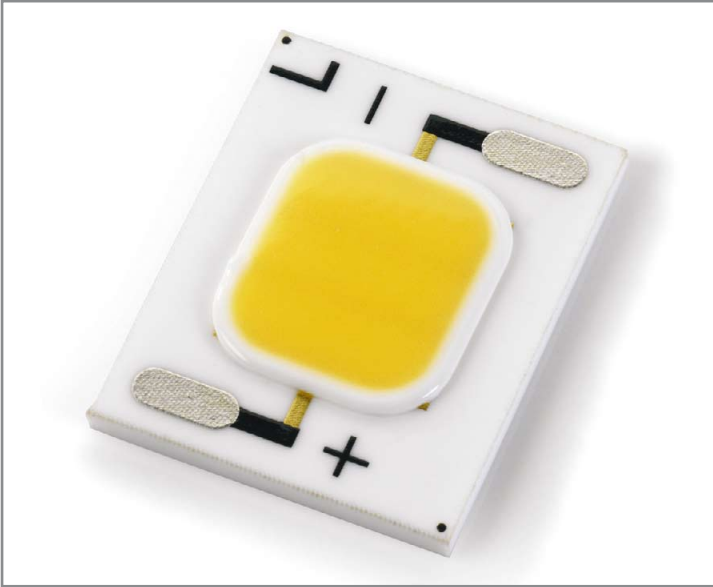

The ceramic carrier material of the MiniZeni is characterised by a high surface quality.

The new models are available in two series: a 6.7 W and a 3.6 W series. Sharp achieves high flexibility in the lighting design through the modular structure of its LED multi-chip modules. The fundamental components here are individual blue LEDs, coated with phosphorous, that are interconnected in a matrix and installed on the ceramic plate. With the 6.7 W Sharp "MiniZeni" series, the square LED matrix consists of a total of 45 LEDs that are arranged in fifteen parallel-switched series of threes and achieve a luminous flux of 355 to 410 lm, depending on the model. On the other hand, the matrix of the 3.6 W consists of a total of 24 LEDs that are arranged in eight parallel-switched series of three and achieve a luminous flux of up to 230 lm.

The benefit of multi-chip LEDs, compared with the large-scale single-chip LEDs with approximately the same luminous flux, lies in their homogeneous distribution of heat. Whereas the heat developing from high-power LEDs has to be transported away over a single point or a very small area, the lower temperatures of multi-chip LEDs resulting from low currents can be distributed and transported away over a larger area. This results in a substantial simplification of heat management.

The ceramic carrier material is also characterised by a high surface quality, resulting in low surface roughness. This simplifies connection to the cooling element, making it as seamless as possible and creating excellent heat dissipation.

The color temperature of the three white light LED lighting modules lies in the range of 2,700 to 5,000 K with the shades "Warm White" and "Pure White". The models of the "MiniZeni" series have a substantially improved CRI value of 87, thanks to various phosphorous mixtures, and thus ensure color fastness and attention to detail. This is vital everywhere where artificial light must not manipulate the illustration of the illuminated objects. 'High color rendering' LED modules are therefore very much in demand in areas such as photography, medical technology (e.g. for OP lights), in shop window decoration and also in the

presentation of merchandise. Merchandise can thus be effectively staged and give a store an unmistakable image; you will also ensure an attractive purchasing experience for the customer. With regard to their high CRI values and their color temperatures, the series of the "MiniZeni" LED modules correspond to the requirements of the international Energy Star Programme, which specifies a CRI value of at least 80. They can thus be used both in innovative LED lighting systems and in those places where fluorescent tubes have previously been used as the light source. ■

Avago Technologies: Industry's First Water-Resistant PLCC-High-Brightness LEDs

Avago announced the industry's first compact high-brightness water-resistant tricolor surface mount LEDs for use in indoor and outdoor full color signs and displays. These PLCC-4 and PLCC-6 surface mount LEDs are ideal for exterior and interior full color sign applications.

Features:

- Industry Standard PLCC-6 package with individual addressable pin-out for higher flexibility of driving configuration
- High reliability LED package with silicone encapsulation
- High brightness using AlInGaP and InGaN dice technologies
- Wide viewing angle at 115°
- Compatible with reflow soldering process
- JEDEC MSL 2a
- Water-resistant (IPX6x) per IEC 60529:2001

Applications:

- Indoor and outdoor full color display

This family of SMT LEDs packaged in the form of PLCC-6 with separate heat path for each LED dice, enabling it to be driven at higher current. These SMT LEDs have high brightness and reliability performance and are designed to work under a wide range of environmental conditions. This high reliability feature makes them ideally suited to be used under exterior and interior full color sign application conditions.

To facilitate easy pick & place assembly, the LEDs are packed in EIA-compliant tape and reel. Every reel will be shipped in single intensity and color bin; except red color to provide close uniformity.

This super wide viewing angle at 115° together with the built in reflector pushing up the intensity of the light output makes these LEDs suitable to be used in electronics signs. The black top surface of the LED provides better contrast enhancement especially in the full color sign application. ■

Toshiba Electronics Europe: Highly Efficient New Miniature HP White LEDs

Toshiba Electronics Europe (TEE) has announced three new high-brightness, miniature white LEDs that will allow designers to deliver high-efficiency solid-state solutions for a wide range of commercial, residential and industrial lighting.



TL12W03-xx are the improved versions of the well known TL12Wxx-series LEDs.

With a drive current of 350mA, the new TL12W03-D white, TL12W03-L warm white and TL12W03-N neutral white LEDs deliver high typical luminous flux ratings of 90 lumens, 75 lumens and 100 lumens respectively. As a result they offer high-efficiency, high-reliability alternatives to incandescent, fluorescent and halogen bulb technologies in general lighting designs.

The new LEDs are supplied in miniature surface mount packages with dimensions of just 10.5mm x 5mm x 2.1mm. All of the devices will operate at temperatures between -40°C and 100°C, making them suitable for both indoor and outdoor lighting applications.

As with other models in Toshiba's LED family, the package technology has been designed to ensure a low thermal resistance. This ensures improved heat dissipation characteristics, which simplifies thermal management in the target lighting design.

All of the new LEDs are rated for a maximum forward current (IF) of 500mA and a typical forward voltage (VF) at 350 mA of 3.3 V. Maximum power dissipation for the LEDs is rated at 1.95 W. ■

Infineon Drives Innovation in LED Lighting

At the Applied Power Electronics Conference (APEC), Infineon Technologies AG (FSE: IFX / OTCQX: IFNNY) introduced its specific off-line driver IC for high-efficiency LED bulbs with dimming for residential lighting. With a flexible architecture that supports very cost-effective 40W/60W/100W incandescent bulb replacement and all typical consumer lighting applications, the ICL8001G sets a new benchmark with respect to integration, performance, features, and total system cost. The ICL8001G enables up to 90% efficiency, supports a broad variety of already installed wall dimmers, and is the only primary controlled off-line LED drive solution with integrated Power Factor Correction (PFC). It achieves a power factor exceeding 98%.

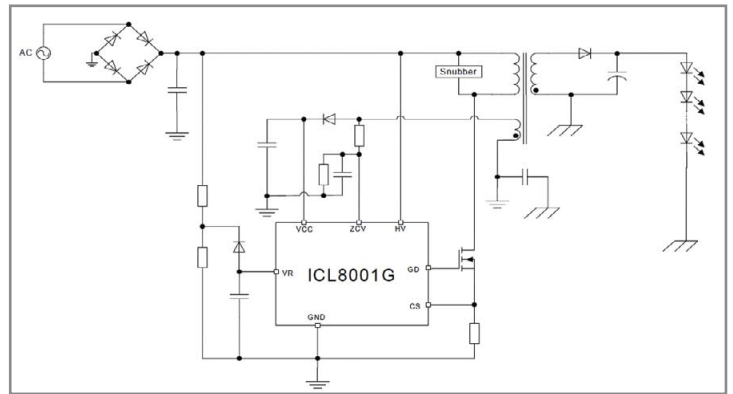

A typical application circuit using the Infineon ICL8001G.

Driver boards based on the ICL8001G implement an innovative primary control technique to manage the power consumption of LEDs. Using just 25 components for a 10W LED (60W equivalent) lamp, which is a 50% reduction compared to alternatives and a cost reduction of approximately 30%, the printed circuit board area of the reference design is just 20mm x 70mm. At that size the PCB can easily be embedded within the common screw-in form factor of a lamp bulb. All components are assembled on a single-sided PCB, contributing to further cost reduction.

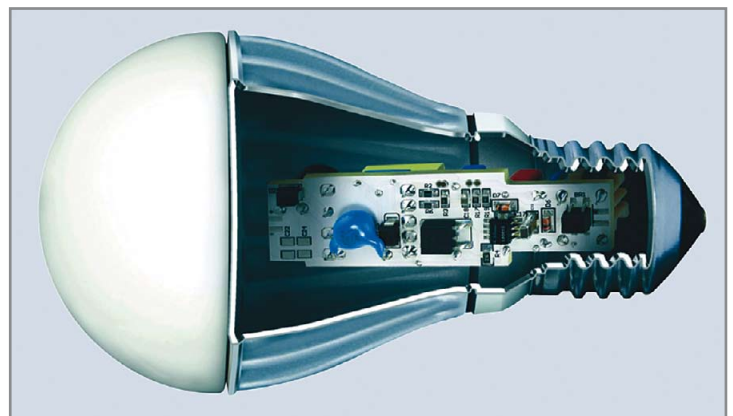

Using the ICL8001G, just 25 components are necessary for a 10W LED bulb.

Compliance with ANSI C78.377 in 2009 ⇒ MacAdam 3-step in April, 2010

Narrower Chromaticity Range (2,700K~4,000K)

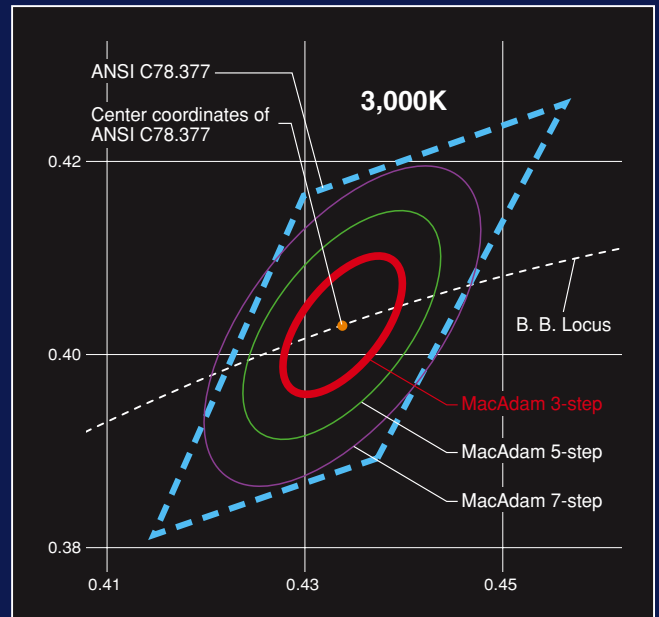
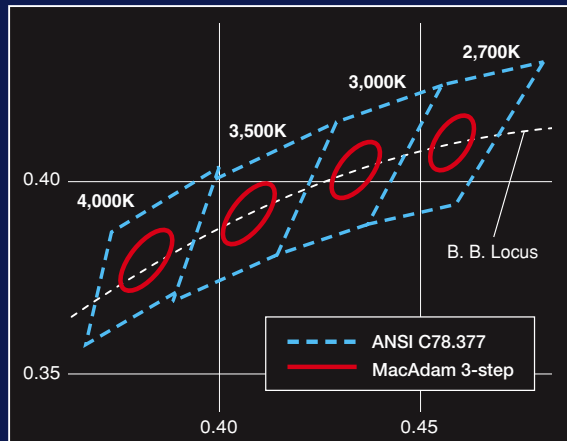

● Applicable packages

CL-L103 Series



CL-L251 Series

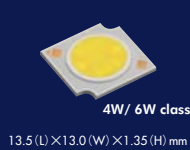

CL-L233 Series



Citizen Electronics efforts:

Chromaticity control of CITILED has been shifted from Sorting after production to Elaboration in production. CITILED (2,700K~4,000K) provides MacAdam 3-step based on continuous technology improvement.

Visit us at
Light+Building 2010 in Frankfurt
April 11-16 / Citizen booth : Hall 4.2, booth No. J81

Visit us at
LFI 2010 in Las Vegas
May 12-14 / Citizen booth : 859

NEW release

High level of luminous efficiency

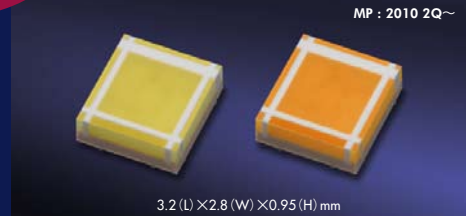

CL-L270 Series (0.2W class)

If: 60mA
3,000K (Ra85) : 16.7 lm · 83.1 lm/W
5,000K (Ra68) : 20.5 lm · 102.0 lm/W

▶ Please contact us for samples!

CITIZEN ELECTRONICS CO., LTD.

CITIZEN
Micro HumanTech

Distributors

Italy : Velco S.p.a. **velco** S.p.a.

Contact person : Paola Tonel Tel : +39-0444-922-922 E-mail : info@velco-electronic.com

Germany / Austria / Switzerland : Endrich Bauelemente Vertriebs GmbH **endrich**

Contact person : Albrecht Lohrer Tel : +49-7452-600756 E-mail : a.lohrer@endrich.com

England : Marl International Ltd. (Optosource) **MARIL**

Contact person : Clare Millard Tel : +44-1229-582430 E-mail : clare.millard@optosource.com

France : Eurocomposant **EP**

Contact person : Patrick Fichot Tel : +33-1-30-64-2602 E-mail : pfichot@eurocomposant.fr

Spain : Antonio Lopez Garrido, S.A.

Contact person : Jose Luis Garrote Tel : +34-96-192-06-34
E-mail : ventas@algsa.es (for sales) / laboratorio@algsa.es (for technical assistance)

Scandinavia / Baltic states / Russia : Arrant-Light Oy **www.light.fi**

Contact person : Janne Makinen Tel : +358-2-2462-300 E-mail : janne.makinen@light.fi

Belgium / Netherlands / Luxembourg : Elincom Electronics B. V. **elincom**

Contact person : Michiel Wubs Tel : +31-10-264-0270 E-mail : m.wubs@elincom.nl

Turkey : empa electronics **empa::electronics**

Contact person : Volkan Akbiyik Tel : +90-212-465-71-99 E-mail : citiled@empa.com

Contact

Europe Tel : +49-69-2992-4810
North America Tel : +1-847-619-6700
Japan Tel : +81-3-3493-2744
Asia Tel : +852-2793-0613
Other areas inquiry@ce.citizen.co.jp

Please contact us for distributors
in other countries.

● Requests / Inquiries

E-mail : inquiry@ce.citizen.co.jp

http://ce.citizen.co.jp/lighting_led/en/

The Infineon driver solution operates with many phase cut dimmers and maintains high efficiency (> 80%) over the complete dimming range, unlike many existing solutions.

Other features of the ICL8001G include isolated driver output for efficient thermal management; digital soft-start and an integrated start-up cell for instant on; cycle by cycle current limitation; short circuit, over voltage protection and over temperature detection.

Applications:

- 100W / 60W / 40W incandescent bulb replacement or lamp retrofit

Key Features:

- Single stage, primary control with PFC and dimming function
- Highly efficient - up to 90%
- Significant BOM cost savings - approx. 30% compared to existing solutions
- Additional energy savings supported within a wide phase-cut dimming range
- Superb light quality - intelligent regulation for flicker free operation
- Unmatched power quality - power factor exceeding 98%
- Isolated driver output for optimized thermal management
- Minimized external component count enables smallest form factor and maximum reliability

The ICL8001G is an off-line switched mode power IC extending the Infineon offering of a comprehensive range of LED driver solutions characterized by robustness and cost-effectiveness, meeting the evolving and expanding requirements of lighting applications. ■

Micrel: New Step Down High Brightness LED Driver IC

Micrel Inc. rolled out the MIC3201, a new Step-Down High Brightness LED (HBLED) driver with high-side current sense. This device is the first in a new series of high brightness LED drivers targeting MR-16 lamps and other general illumination applications. This device reduces the size, complexity and cost of the driver solutions for various lighting applications.

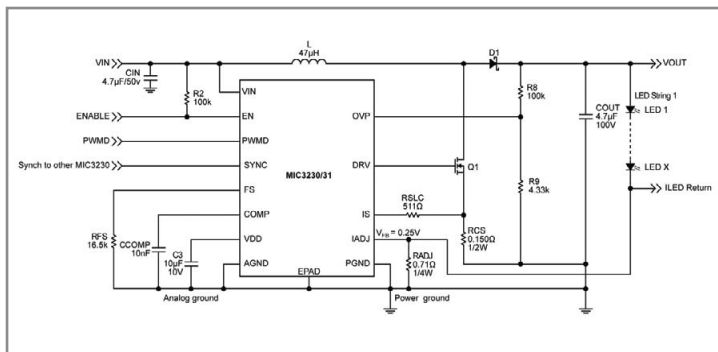

Functional diagram for a typical application with the MIC3201.

Features:

- 6 V to 45 V input supply range
- Capable of driving up to 70 W
- Ultra low EMI via dithering on the MIC3231
- Programmable LED drive current
- Feedback voltage = 250 mV \pm 3%
- Programmable switching frequency (MIC3230/1) or 400kHz fixed frequency Operation (MIC3232)
- PWM dimming and separate enable shutdown
- Frequency synchronization with other MIC3230s
- Protection features: Over Voltage Protection (OVP), Over Temperature Protection (OTP), Under Voltage Lock Out (UVLO)

Applications:

- Street lighting
- Solid state lighting
- General illumination
- Architectural lighting
- Constant current power supplies

The MIC3201 is capable of driving up to four, 1 A HBLEDs in series at more than 90% efficiency with \pm 5% current accuracy from input voltages of 4.5V to 20V. With its hysteretic control architecture and high-side current sense scheme, the MIC3201 is well positioned to provide constant current with changes in input voltage and output load. The MIC3201 operating frequency is adjustable up to 1 MHz to allow flexibility in the design. The MIC3201 features a dedicated PWM dimming pin, an enable pin for very low power shutdown, OTP and UVLO. The MIC3201 has an internal power switch and requires no external compensation. The MIC3201 comes in an exposed pad SOIC-8L package. ■

On Semiconductor: PFC Dimmable LED Driver

On Semiconductor introduces its NCL30000 LED Driver, a switch mode power supply controller intended for low to medium power single stage power factor (PF) corrected LED Drivers. The device is designed to operate in critical conduction mode (CrM) and is suitable for flyback as well as buck topologies. Constant on time CrM operation is particularly suited for isolated flyback LED applications as the control scheme is straightforward and very high efficiency can be achieved even at low power levels. These are important in LED lighting to comply with regulatory requirements and meet overall system luminous efficacy requirements. In CrM, the switching frequency will vary with line and load and switching losses are low as recovery losses in the output rectifier are negligible since the current goes to zero prior to reactivating the main MOSFET switch.

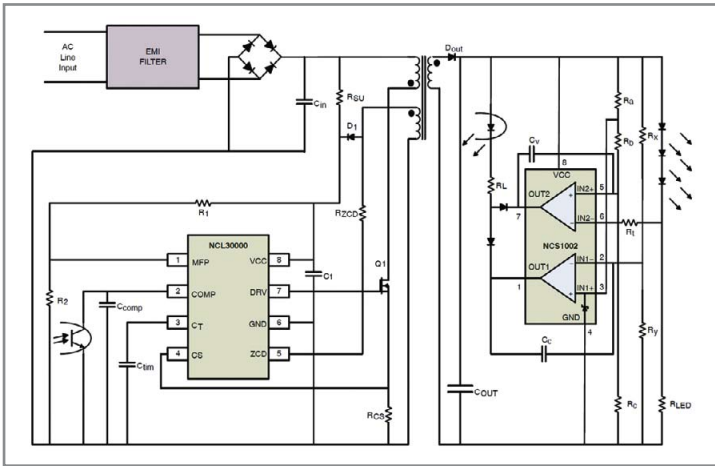

NCL30000 and NCS1002 allow for a simplified flyback application with secondary side constant current control.

Features:

- Very Low 24 μ A Typical Startup Current
- Constant On Time PWM Control
- Cycle-by-Cycle Current Protection
- Low Current Sense Threshold of 500 mV
- Low 2 mA Typical Operating Current
- Source 500 mA / Sink 800 mA Totem Pole Gate Driver
- Reference Design for TRIAC and Trailing Edge Line Dimmers
- Wide Operating Temperature Range
- No Input Voltage Sensing Requirement
- Enable Function and Overvoltage Protection
- Pb-Free, Halogen Free/BFR Free and RoHS Compliant

Typical Applications:

- LED Driver Power Supplies
- LED Based Down Lights
- Commercial and Residential LED Fixtures
- TRIAC Dimmable LED Based PAR Lamps
- Power Factor Corrected Constant Voltage Supplies

Three up to 15 W reference designs are provided and are intended to drive from 4-15 LEDs at 350 mA. They can however, be easily modified to support power levels ranging from 5 W to 30 W:

- NCL30000LED1GEVB: 115 Vac version, 90 to 135 Vac input line (TRIAC Dimmable)
- NCL30000LED2GEVB: 230 Vac version, 180 to 265 Vac (TRIAC Dimmable)
- NCL30000LED3GEVB: Extended universal version, 90 to 305 Vac

Typical applications include LED driver power supplies, LED-based down lights, TRIAC dimmable LED-based lamps and power factor corrected constant voltage supplies. This device is compatible with both leading edge TRIAC-based and trailing edge transistor-based dimmers. Depending on the dimmer used, the LED output can be controlled down to < 2%. ■

Advanced Light Diffusion Technology from Bayer MaterialScience

Designers will enjoy greater creative possibilities with the new advanced light diffusion technology developed by Bayer MaterialScience LLC. Light diffusion technology can be used to disguise LED (light emitting diode) hot spots – hiding the point light source yet allowing higher levels of light transmission. Product designers and original equipment manufacturers (OEMs) can use this versatile technology in just about any lighting application – both indoors and outdoors, from overhead lighting in buildings to parking lot light posts. The breakthrough achieved by the Bayer MaterialScience Color Competence and Design Center in Newark, Ohio, creates the effect of softened LED light with minimal reflection. Until now, light from translucent white colors could be diffused, but never at this light transmission level or with as little reflectance. Using this technology, designers have nearly limitless freedom for their light diffuser packages, with the bonus of a broad palette of colors to customize the application.

„This is an exciting time to be a colorist. Because of our expertise in materials and color technology, we are able to offer product designers and OEMs a design solution specific to their needs, like the new light diffusion technology,” said Terry Bush, senior chemist at Bayer MaterialScience LLC. „At the Color Competence and Design Center, we are able to recommend tailored applications, not just a generic, off-the-shelf solution.”

Creating a high-quality diffuser package begins with selecting a Makrolon polycarbonate resin grade best suited to the particular application.

Material options for customers include:

- Makrolon LED2643: This ultra-high light transmittance LED lighting grade was designed to resist UV light, water exposure and immersion, and is suitable for indoor and outdoor applications.
- Makrolon FR7087: Is believed to be the first clear polycarbonate that passes UL 94 5VA flame rating at 3.0mm, and is ideal for lenses, covers and other electrical applications requiring clarity.
- Makrolon 6717: This is a highly flame retardant grade, designed for extruded applications such as light bars and light guides.
- Makrolon 3103: This is a high-viscosity, UV-stabilized polycarbonate that can be used in a number of applications, including automotive and consumer products.

„No matter what the final lighting application, we likely have a polycarbonate that will meet the application needs. From ultra-transparent to UV-stabilized flame-retardant, our diverse grades of Markrolon polycarbonate resin are generally the best in their class,” said DiBattista. „Our goal is to provide OEMs with a combination of advanced technology and technical expertise that translates into innovations for their products. Our new light diffusion technology is an example of these technological advancements.” ■

New Ocean Optics LED-Light-Measurement System

Now available from Ocean Optics is a light-measurement system for spectroradiometric analysis of LEDs, lamps, flat panel displays and other radiant sources, as well as solar radiation. With its small footprint, powerful microprocessor and low-power display, the new Jaz-ULM-200 is a convenient, versatile alternative to standard light meters and radiometers.



The Ocean Optics Jaz-ULM-200 Light Measurement System collects spectral irradiance data from LEDs, light sources and radiant sources such as the sun.

Jaz is a family of stackable components that share common electronics and communications and are configurable for a variety of applications. Included in the Jaz-ULM-200 stack is a CCD-array spectrometer that can be optimized for a variety of radiometric measurements and a microprocessor with onboard display.

Jaz provides functionality not found in traditional light meters, allowing users to capture, process and store full spectra without the need for a PC. With only three pushes of a button, the system's irradiance-measurement software, which is stored on an SD card, collects full spectral irradiance information from the selected light source. This data can then be post-processed to give the intensity parameter of choice, including W/cm², lumens, lux, PAR (photosynthetically active radiation) or any other light intensity parameter. The system's three-button wizard simplifies operation so that even non-spectroscopy experts are able to perform fast and accurate measurements.

In addition to the Jaz-ULM-200's spectrometer and microprocessor, it includes an Ethernet module to store data via an SD card slot and allows users to connect to the Jaz unit via the Internet. The internet capability enables remote measurements such as solar irradiance and the creation of networked sensing modules. Also included are a rechargeable lithium-ion battery module (with SD card slot) for portability and a special mounting fixture for orienting the Jaz stack horizontally to facilitate hands-free operation.

Additional system components include a direct-attach cosine corrector for collecting radiation within a 180-degree field of view, a carrying case with shoulder strap and a rugged Pelican case for storing all related gear. Software includes the Jaz system software and JAZ-A-IRRAD, an irradiance-measurement application that comes on an SD card. ■

Instrument Systems: New SpecWin Pro Analysis Software

SpecWin Pro, the new generation of control and analysis software for spectroradiometric measuring equipment runs on Windows XP and Vista (32 bit), is easily configured, and automatically calculates all optical parameters of measured spectrums.

This latest version 1.5 of SpecWin Pro features add-on modules that have been optimized for specific applications. The DTS module enables automated display measurements with the DTS 500, a positioning system with five axes. It determines viewing angle-dependent properties of displays and LED modules in various coordinate systems. A 3D diagram depicts spatial radiation patterns obtained from goniometer and DTS measurements.

The Commander module enables the user to automatically conduct series of measurements using all the parameters of a measurement setup, including a positioning system or goniometer.

Details about SpecWin Pro:

SpecWin Pro provides the highest degree of functionality for the operation of Instrument Systems spectrometers. The software is based on a complete new development and incorporates the most recent programming technologies available for Windows Vista.

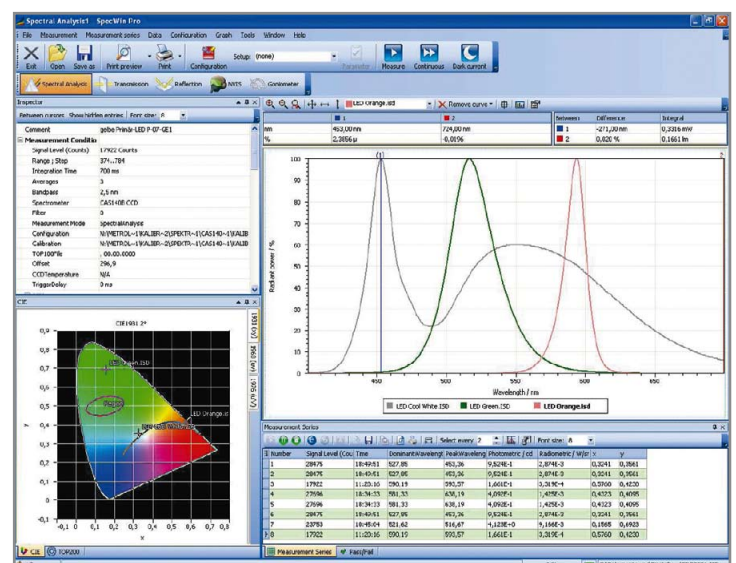

The user interface of SpecWin Pro offers advanced features and an intuitive workflow.

We bring quality to light.

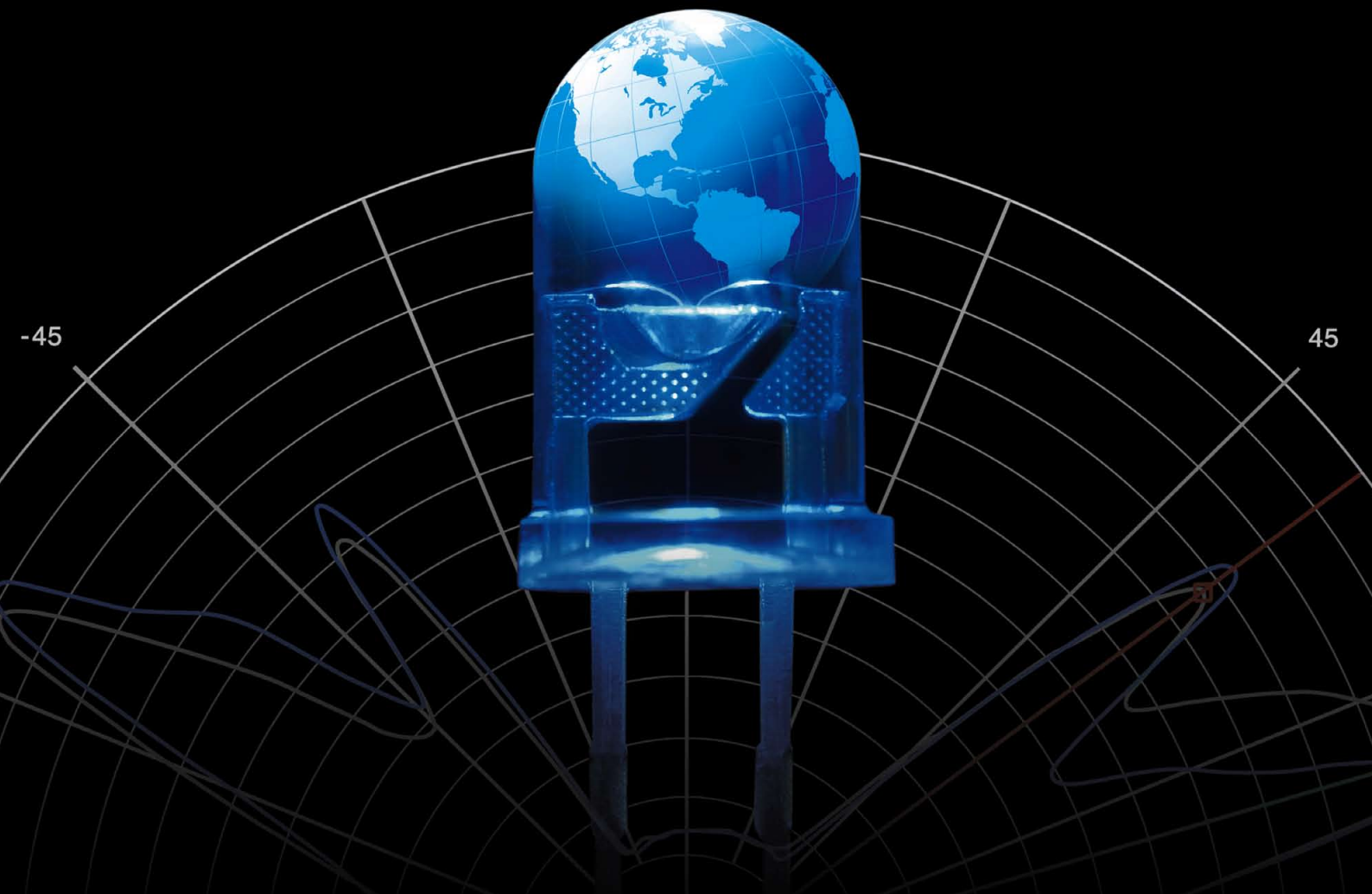

LED test & measurement solutions from the world leader

Instrument Systems continues to set the benchmark in LED metrology. Whether testing individual LEDs (standard or high-power), LED modules, or OLEDs - the global LED industry relies on us to engineer superior measurement equipment for high-speed production testing and high-performance R&D and QC applications.



Our instruments provide accurate and reliable results as per CIE recommendations and methods:

- Luminous flux [lm], luminous intensity [cd], and luminance [cd/m²]
- Chromaticity coordinates x,y,z and u'v'
- Color temperature and color rendering index
- Dominant wavelength and spectral data
- Spatial radiation pattern

 **Instrument
Systems**
light measurement

Features:

- Runs under Windows XP / Vista
- Compatible with the MAS 40, CAS 140B/CT, SPECTRO 320 R4 und R5 spectrometer series
- Supports LEDGON 100, TOP 200, DTS 500 and MiniGon
- Add-ons for Keithley 2400 und 2600 Sourcemeter as well as for the LED 720 current source

Applications:

- Spectral analysis of all types of light source
- LED measurements
- Display measurements, including NVIS measurements according to MIL-L-85762A or MIL-STD-3009
- Transmission und reflection

SpecWin Pro further supports the comprehensive range of accessories available from Instrument Systems. An add-on extends full compatibility to the Keithley 2400 und Keithley 2600 series current sources.

SpecWin Pro provides a separate window for each application, comprising the entire application-specific options dialog, visualizations and analysis. Furthermore, a predefined report page is linked with each measurement window. The report contents can be individually changed.

SpecWin Pro has the option to acquire and document a series of measurements. Important set-up options and relevant measurement parameters can be chosen from a list and included in the documentation. Each measurement is then appended to a continuous results table which can be easily exported to MS Excel for further analysis. An integrated Pass/Fail function allows convenient monitoring of specific measurement conditions or results. ■

Ultratech: Sapphire 100 Lithography System for HB-LED Manufacturing

Ultratech, Inc. introduced its newest lithography system, the Sapphire 100 for high-brightness light-emitting diode (HBLED) manufacturing. By leveraging its lithography and technology leadership, the Sapphire 100 lithography system is designed to enable Ultratech customers to meet the growing demand for illumination products with HBLED technology. Today this demand is driven by strong growth in LED backlighting applications, with even greater potential from energy savings as the world intensifies its energy conservation efforts with the implementation of LED-based, solid state lighting. Currently in beta, Ultratech's production-ready Sapphire 100 lithography system will be available in the second half of 2010.

According to Strategies Unlimited, illumination is expected to become the fastest growing segment of HBLEDs (2007 - 2012 CAGR of 36%). Future growth in the LED lighting market is expected to come from a mix of sources, such as street and parking lights, and indoor residential and

office applications. It is estimated that the potential annual energy cost savings is in the \$10 billion - \$100 billion per country range. Building on this expectation, Ultratech has designed the Sapphire 100 to provide competitive advantages for its HBLED manufacturing customers.

Doug Anberg, Ultratech's vice president of advanced stepper technology, noted, "Today, approximately 25% of electricity is used for lighting. As energy conservation efforts continue to increase, we expect lighting products with HBLED technology to be in high demand. The development of our Sapphire 100 system is an example of our long track record of anticipating industry trends and providing high value to meet the changing needs of our global customers. We look forward to working with leading HBLED manufacturers and establishing their competitive advantages with Ultratech lithography systems for the burgeoning illumination market."

Sapphire 100 Lithography System:

Building upon the cost and performance advantages of the highly reliable 1500 platform, the Sapphire 100 system offers the added advantage of Ultratech's patented Machine Vision System (MVS). The MVS delivers alignment flexibility with significant advantages over standard alignment techniques. The Sapphire 100 was specifically designed to meet the wide range of lithography needs for the HBLED manufacturing industry. ■

AIXTRON's AIX G5 System Achieves Aggressive Productivity Targets

AIXTRON AG announced that its next generation MOCVD Platform AIX G5 HT has demonstrated high quality GaN deposition at very high growth rates and high pressure above 600mbar and superior GaN/InGaN uniformities. The epitaxial runs were performed at Epistar Corporation, located in the Hsinchu Science-based Industrial Park, Taiwan consecutively without reactor baking or swapping of any parts. The MOCVD reactor is now being transferred into mass production.

The Next Generation Platform AIX G5 HT provides the largest wafer capacity (56x2" / 14x4" / 8x6") and comes with revolutionary new reactor design features that allow high growth rates and consecutive runs without baking or swapping of parts. In total, this leads to a more than doubled high quality throughput compared to the previous generation.

The new reactor design provides highest process flexibility combined with superior process stability. AIX G5 HT systems provide fastest time to production with highest reproducibility from tool-to-tool, which enables a faster production ramp up as compared to any other reactor, with easy copy-and-paste process transfer, a key factor in a rapidly booming market with limited numbers of available process experts.



2nd generation LED lightings for decorative solutions.

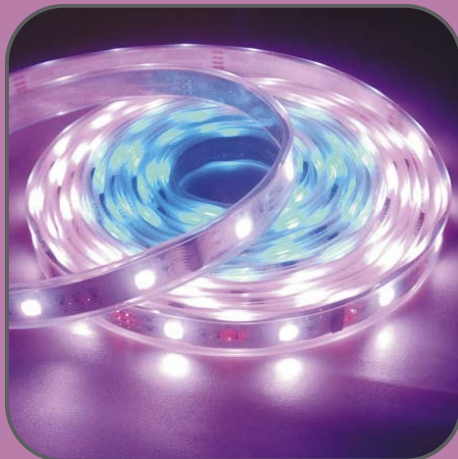

<http://www.signcomplex.com>

Dr. Ming-Jiunn Jou, President of Epistar, comments: "AIXTRON was committed to the challenging targets for the new reactor when we started our cooperation. Now we are amazed how quickly AIXTRON has met its commitments. Furthermore, the uniformities seen so far have given us confidence to significantly improve our production yield on this new MOCVD reactor. We are now very keen to bring this new tool into production and to benefit from its improvements."

Gerd Strauch, Vice President, Corporate Product Design & Engineering, and responsible for Planetary Reactor Development at AIXTRON AG comments: "I am very pleased to see this fast progress at Epistar, as it is in accordance with our expectations. It confirms the excellent target-oriented design of our new reactor chamber, and it is proof of our advanced CFD modelling and system qualification at our own laboratory. We have successfully transferred the epitaxial growth performance from our laboratory 1:1 to the system at Epistar's site." ■

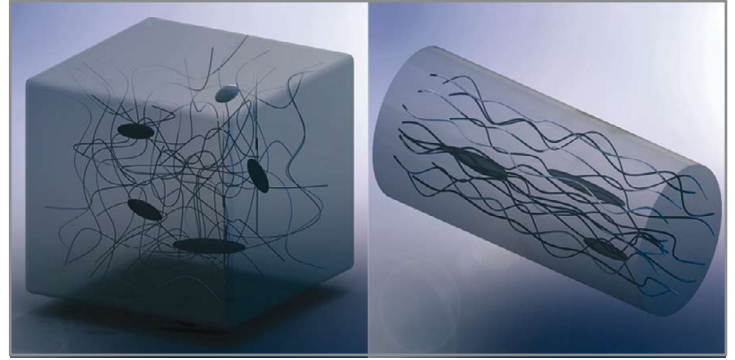

On the left, an illustration of the tangled nature of the polymer filaments, with heat-stopping voids indicated as dark blobs. When drawn and heated into a thin thread (right), the molecules line up and the voids are compressed, making the material a good conductor. (Illustration courtesy of Gang Chen)

The key to the transformation was getting all the polymer molecules to line up the same way, rather than forming a chaotic tangled mass, as they normally do. The team did that by slowly drawing a polyethylene fiber out of a solution, using the finely controllable cantilever of an atomic force microscope, which they also used to measure the properties of the resulting fiber.

This fiber was about 300 times more thermally conductive than normal polyethylene along the direction of the individual fibers, says the team's leader, Gang Chen.

The high thermal conductivity could make such fibers useful for dissipating heat in many applications where metals are now used, such as solar hot water collectors, heat exchangers and electronics.

Chen explains that most attempts to create polymers with improved thermal conductivity have focused on adding in other materials, such as carbon nanotubes, but these have achieved only modest increases in conductivity because the interfaces between the two kinds of material tend to add thermal resistance. "The interfaces actually scatter heat, so you don't get much improvement," Chen says. But using this new method, the conductivity was enhanced so much that it was actually better than that of about half of all pure metals, including iron and platinum.

Research News

MIT Team: Polymers That Could Dissipate Heat

Most polymers – materials made of long, chain-like molecules – are very good insulators for both heat and electricity. But an MIT team has found a way to transform the most widely used polymer, polyethylene, into a material that conducts heat just as well as most metals, yet remains an electrical insulator.

The new process causes the polymer to conduct heat very efficiently in just one direction, unlike metals, which conduct equally well in all directions. This may make the new material especially useful for applications where it is important to draw heat away from an object, such as a computer processor chip or an LED.

Kingbright

www.kingbright-europe.de

+49 2835 - 44 46-0

Kingbright's most popular Through-hole and SMD-LEDs in super-bright pure-orange



KP-1608



KP-3216



L-7113



L-7104



KP-2012



KA-3528

Dominant wavelength: 605 nm • Peak wavelength: 611 nm • Forward voltage: typ. 2,2V – max. 2,8V

Luminous intensity up to typ. 18.000 mcd @ IF 20mA

Quality — Efficiency — Innovation — First-class service

Producing the new fibers, in which the polymer molecules are all aligned instead of jumbled, required a two-stage process, explains graduate student Sheng Shen. The polymer is initially heated and drawn out, then heated again to stretch it further. "Once it solidifies at room temperature, you can't do any large deformation," Shen says, "so we heat it up twice."

Even greater gains are likely to be possible as the technique is improved, says Chen, noting that the results achieved so far already represent the highest thermal conductivity ever seen in any polymer material. Already, the degree of conductivity they produce, if such fibers could be made in quantity, could provide a cheaper alternative to metals used for heat transfer in many applications, especially ones where the directional characteristics would come in handy, such as heat-exchanger fins (like the coils on the back of a refrigerator or in an air conditioner), cell-phone casings or the plastic packaging for computer chips. Other applications might be devised that take advantage of the material's unusual combination of thermal conductivity with light weight, chemical stability and electrical insulation.

So far, the team has just produced individual fibers in a laboratory setting, Chen says, but "we're hoping that down the road, we can scale up to a macro scale," producing whole sheets of material with the same properties.

Ravi Prasher, an engineer at Intel, says that "the quality of the work from Prof. Chen's group has always been phenomenal," and adds that "this is a very significant finding" that could have many applications in electronics. The remaining question, he says, is "How scalable is the manufacturing of these fibers? How easy is it to integrate these fibers in real-world applications?"

This work, which also included Chen's former graduate students Asegun Henry and Jonathan Tong, was supported by the National Science Foundation and the Department of Energy's Office of Basic Energy Sciences. ■

Event News

OLED Lighting Design Summit

The hype surrounding OLED lighting has been building for years, based on its innovative and versatile form factor, low energy consumption and place as an area source. Many scientific breakthroughs and rounds of funding later, OLED panels are becoming commercially available, and are drawing the keen eye of the world's most innovative lighting designers.

The technology represents a groundbreaking and game-changing opportunity for every player in the lighting industry. Leading analysts Display Search estimate the market will be worth over \$6 billion by 2018 and the lighting designers who get their business ready now will be the ones who see the lion's share of the profits.

www.led-professional.com



High Quality Optics



LEDiL products cover over 450 standard lens and reflector solutions, enabling an almost unlimited range of possibilities for different applications.

Indoor applications:

- Down lights
- Emergency lights
- Torch lights
- Decorative lights
- Architectural lighting
- Reading lights

Outdoor applications:

- Street lighting
- Architectural lighting
- Automotive lighting
- Park lighting
- Public lighting

Supported LEDs :

Cree, Osram, Sharp, Nichia, Luxeon, Seoul Semiconductor, Samsung, Luminus, Bridgelux, Citizen, LedEngin, Intematix and Everlight



For price and sample inquiries, please contact: sales@ledil.com.

For technical information and test kits, please visit www.ledil.com or contact: engineering@ledil.com.

Meet us at the Light + Building Fair in Frankfurt in 11. - 16.4.2010. Hall 4.1 D50

The summit takes place in London, on June 21-22 and is the first and only event focused exclusively on OLED technology for lighting design. You'll experience 2 days of world exclusive design case studies, lively panel debates, interactive roundtable discussions and hands on workshops.

The agenda is tightly focused on what the Lighting industry needs to hear:

- OLED performance fact pack: From efficiency to aging, color, reliability and cost. All the answers you need to start working with OLEDs
- Light designers' OLED toolkit: Get an exclusive insight into how OLED technology will add value to many types of light installations and broaden design capabilities through improved color range, viewing angles and more
- Hands-on OLED master-class: Interact, test and really explore OLED technology, so you come away with a thorough understanding of how they work and the full extent of what they can and can't do
- OLED design case studies: Come face to face with the largest and most innovative lighting designers in the world as they candidly discuss how and why they are using OLED
- What the future holds for OLED: Realistic predictions as to when, where and how OLEDs are going to hit the market, and what they'll be able to do when it happens

Download your brochure at www.oledinsider.com/lighting-design or visit www.oledinsider.com/lighting-design. ■

All Big Names at Light+Building 2010

Around 2,200 exhibitors, including all national and international market leaders, will exhibit at Light+Building, The World's Leading Trade Fair for Architecture and Technology, in Frankfurt am Main from April 11th to 16th, 2010. On an area of over 240,000 square metres at the fully booked-up exhibition centre, Light+Building presents innovations and energy-saving system solutions in the fields of lighting, electrical engineering and house and building automation under the motto, 'energy efficiency'. But how can visitors find what they need from this huge range of products and services? The answer is: "Easily", thanks to logically arranged product groups, which enable visitors to find their way around quickly and without difficulty. Now, as the result of an optimised layout for building-services technology, this will be even easier at Light+Building 2010. Additionally, initial orientation is given by the three product sections: lighting, electrical engineering and house and building automation.

At the world's biggest platform for the lighting market, over 1,500 companies present the complete range of lighting technology including technical luminaires and lamps of all kinds and for all applications, designer luminaires in all styles from classic to modern

and a huge selection of lighting components and accessories. At Light+Building, visitors can be sure of finding all future-oriented lighting technologies, such as LED luminaires for commercial and public buildings, as well as for the home.

Technical luminaires and lamps occupy five exhibition halls – 3.0, 3.1, 4.0, 4.1 and 4.2 – as well as the 'Forum' and the 'Festhalle'. The international companies making their presentations in Hall 3 include Artemide, Bega Gantenbrink-Leuchten, Erco Leuchten, Flos, Fontana Arte, iGuzzini illuminazione, Luceplan, Trilux and Targetti Sankey. In the 'Festhalle' and 'Forum', Osram, Philips, Siteco Beleuchtungstechnik and Zumtobel Lighting number among the companies represented. Urban Lighting Presents the Multi-Faceted Spectrum of Outdoor Lighting

Located in Hall 5.0 and focusing primarily on outdoor luminaires for public areas, the multi-faceted spectrum of outdoor lighting will be presented by numerous companies, including Ewo, Hess AG Form + Licht, Schröder and Thorn Lighting, under the heading Urban Lighting. Additionally, outdoor luminaires will be exhibited in a realistic setting at the Outdoor Lighting Boulevard on the Agora, the outdoor exhibition area of the Fair and Exhibition Centre.

Decorative luminaires of all styles for the home and the contract market will be on show in Halls 5.1, 6.0 and 6.1. Decorative Light is split into three main styles – modern, classic-modern and classic traditional – to make it easier for visitors to find their way around this product segment. Among the exhibitors showing classic decorative luminaires in Hall 6.1 are, for example, Arte di Murano, Classic Light, Iris Cristal, Joachim Holländer, Novaresi, Pataviumart and Savoy House; modern decorative luminaires are located in Hall 5.1 and the exhibitors include Bankamp, Menzel lighting manufacture group and Neuhaus Licht. Additionally, companies such as Albert Leuchten and Royal Botania present outdoor luminaires for the private sector in this exhibition hall.

The importance of design not only for decorative luminaires but also for technical lighting is clearly to be seen from the spectrum of technical design-oriented luminaires, which can be seen in Halls 1.1 and 1.2. The renowned companies exhibiting in this product segment include, for example, Axel Meise Licht, Brand van Egmond, DARK, Escale, Ingo Maurer, Metalarte, Nimbus, Oligo, Prandina, Quasar, Serien, Terzani and Tobias Grau.

Rounding off this vast array of lighting products are full-range suppliers and decorative accessories in Halls 6.0 and 10.1. The exhibitors there include Brilliant, Eglo Leuchten, Massive Leuchten and Paulmann Licht. In Hall 10.1, national pavilions present more products from this segment.

Technical components and accessories for lighting applications are located in Hall 4.0. Renowned exhibitors in this segment include, for example, Alanod, BAG Electronics, BJB, Helvar, Jordan Reflektoren, TCI, VLM SPA and Vossloh-Schwabe.

This Year, Strong Focus on LEDs

Many new exhibitors from the LED sector are taking part in the technical luminaires and lamps segment at Light+Building 2010, for example, LG Innotek, Sharp Electronics and Toshiba. Together with other leading LED manufacturers, such as Nichia, Panasonic Lighting and Seoul Semiconductors, they can be found in Halls 4.0, 4.1 and 4.2.

Numerous companies announced new LED product lines and some others their first in-house manufactured LED or OLED products:

LED technology and sustainability are a main focus:

For example WE-EF will also offer an LED option, along with new optical systems, apart from the RFL500 series the PFL200 street and area lighting luminaires. The WE-EF engineers have optimised the lens systems in such a way that in the future there will be three different designs which offer state of the art lighting technology.

Brand-new LED driver and controls products can be expected:

Integrated Mains Driver products: compact and easy-to-configure AC LED driver/controllers targeted at white light, tunable white light and (dynamic) full color applications.

eldoLED, e.g. will present its 12VAC technology: for 12V AC LED luminaires and halogen lamp replacement products. Going up to 15 W, key features include: high efficiency, a 0.8 power factor, flicker-free light output, compatibility with standard household dimmers and smooth dimming.

At the eldoLED stand you will also see various color versions of the PowerPIX modules - white, amber, RGBW/A - displayed in different application forms varying from direct pixelated to distributed tunable white light or dynamic full color.

The next-generation DimWheel Color: a complete LED dimmer solution that is ready-to-install thanks to the integrated back box and mounting plate which meet EU, UK and US wall box requirements. One-button on-off/dimming/color/show control.

Zumtobel, Philips, Osram and Nimbus showcased their LED Highlights in advance at the L+B-PreView in Hamburg:



Zumtobel showed the "Panos Infinity", a new LED downlight ...



... and the LED replacement bulb, manufactured by their subsidiary LEDON Lamps.



Philips came to Hamburg with a complete range of replacement bulbs like the "Novalure" E14,...

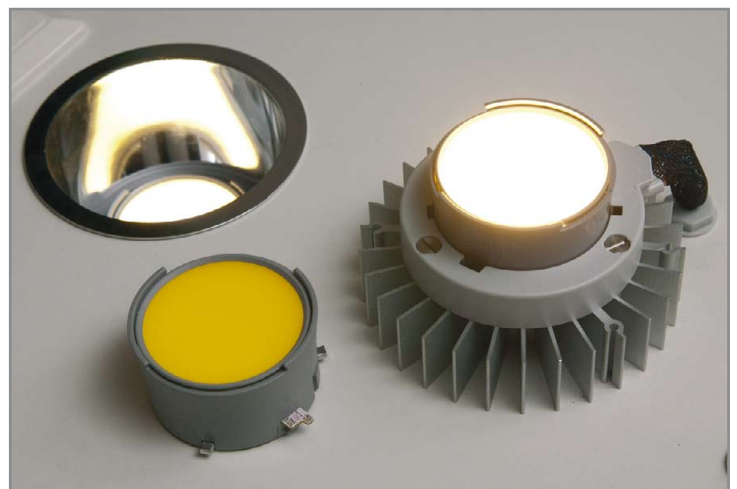

...and the redesigned "Fortimo" downlight...



... as well as new street lamps. For example the "CitySoul Ledgine".

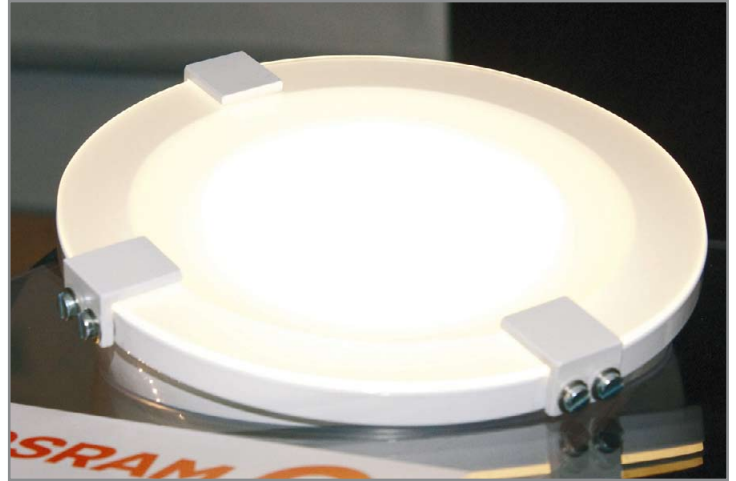

... and the "PrevaLED".

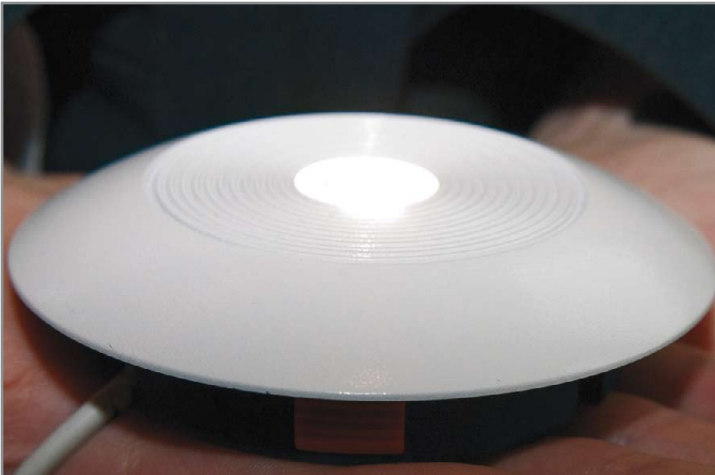

One of Osram's highlights is the new range of LED downlights from small LED downlights ("LED-Downlight S")...



Nimbus, known for their clear design inspired the audience with their Q36 LED module.



... to the big ones like the "LED-Downlight L"...



Some manufacturers, like Osram, announced that they will be showing lighting options with OLEDs. Others like Philips and Zumtobel are expected to show at least some studies and prototypes.

■
All images courtesy of PreView Event and Communications and Osram.

www.osram-os.com

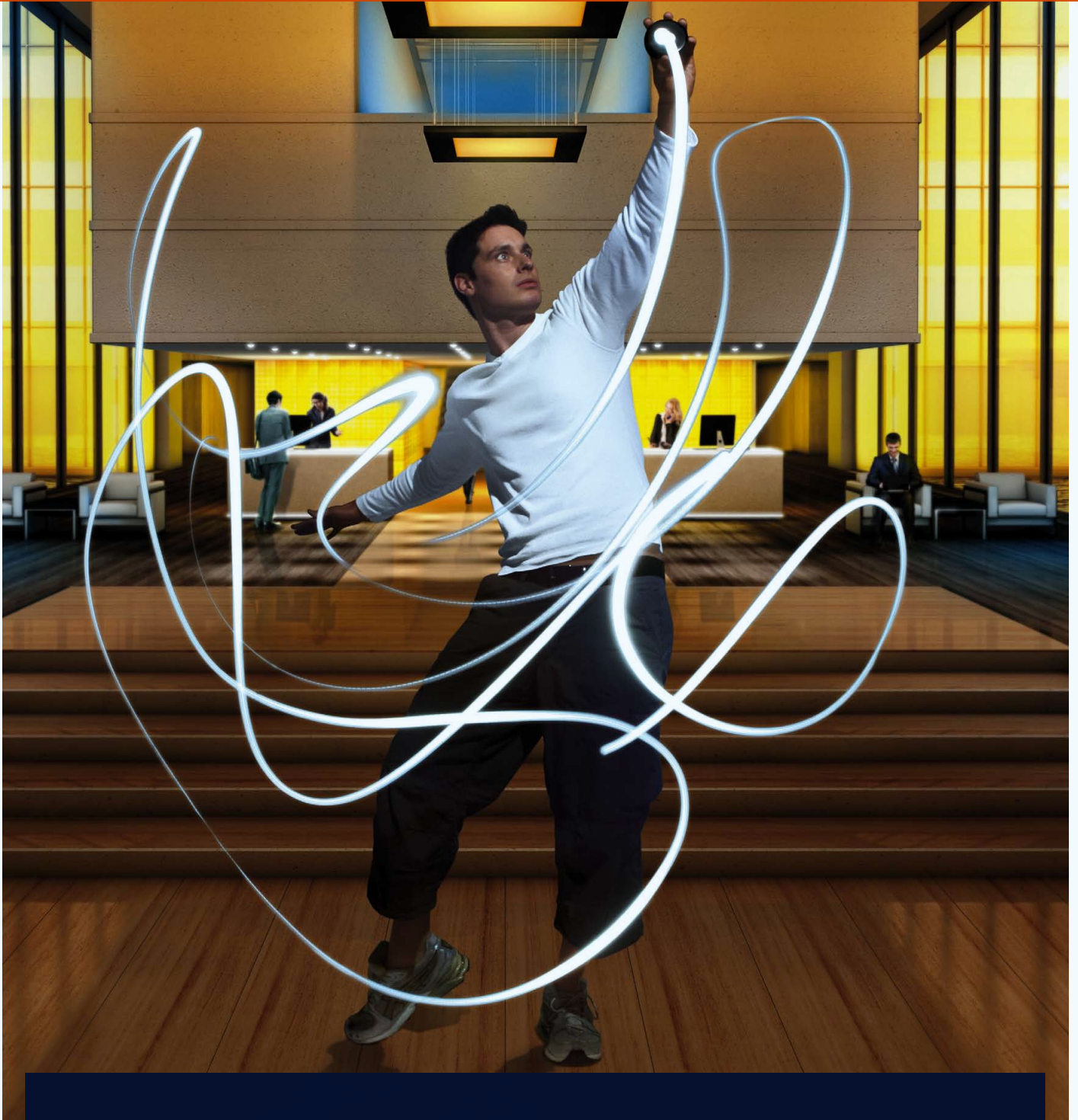

LEDs for General Lighting Solutions

OSRAM Opto Semiconductors empowers lighting solutions for today and tomorrow

OSRAM
Opto Semiconductors

Application

LED in General Lighting Applications

> Dr. Günther Sejkora, items – Innovation and Technology Management

In the early years of this decade the predictions regarding market growth of LED luminaires for general lighting applications were huge. Looking at the figures at the end of the decade we must consider that LED has mainly conquered some niche applications and most of the typical applications in general lighting are still dominated by "old" technologies like fluorescent, halogen bulb and even incandescent lamps.

Looking more into detail, several reasons for this discrepancy between prediction and reality are obvious:

- Initially LEDs were used mainly in color applications which offered good premises for LED usage: a unique technology which is able to serve new applications and highly emotional effect of RGB lighting on humans. The correlated fast market growth for colored LED could not be assigned to white LED. In white light applications LED has to battle against mature light source technologies (high performance and quality, low cost) which slows down market penetration of LED technology.
- Technical handicaps like color tolerances, brightness tolerances, complex optical systems and thermal management.
- Relatively high initial costs for LED lighting installations.
- LED is a disruptive technology. Existing value chains (lamp – ballast – luminary) do not fit with LED technology and therefore it is a danger for existing business models in the lighting industry. The result is resistance which slows down market penetration.

Technological development of LEDs in the past years was mainly driven by increasing the light output of LEDs. It was largely decoupled from the needs arising from the applications in general lighting. If we want to increase the speed of market penetration of LED we have to focus on light applications and derive the tangible demands for LED technology from them.

The following will exemplify several applications. Of course each application makes different demands on LED technology, and the article will focus on the most important ones.

Architainment

Architainment is an artificial word coming from "architecture" and "entertainment". In this application, light (mostly colored light) is used to make buildings more attractive and entertaining by highlighting structures in the architecture, generate different spatial appearances by changing colors and/or light and shadow effects. Architainment was extensively developed with and by LED lighting.

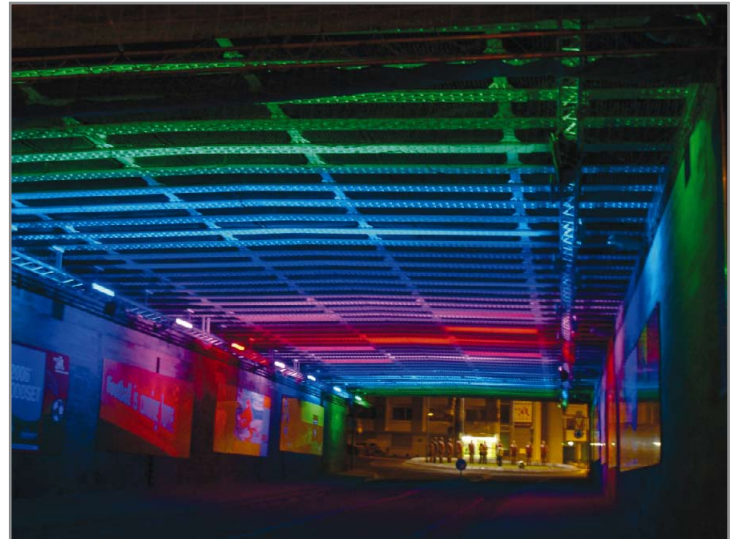

Figure 1: Passage to the Betzenberg, Kaiserslautern (Germany). RGB LED Lighting generates an attractive and inviting atmosphere and models the structure of the steel construction. (© Florian Schneider/Pixelio).



Figure 2: University of Darmstadt (Germany). The balustrade is covered by a 16 m wide RGB LED display to generate graphical effects and act as an info-board as well (© University of Darmstadt).

A typical problem that appears in architainment applications are tolerances in chromaticity and brightness of the LED. Using single color LED chromaticity variance can be kept within limits by binning and brightness tolerances are not so important due to the non-linear brightness perception of the human eye.

If colors are mixed from different colored LED (e.g. RGB), the superposition of chromaticity tolerances of the red, green and blue LED leads to chromaticity tolerances that are in the range of 10 McAdam ellipses (below 1 McAdam ellipse chromaticity differences are not perceivable, <5 McAdam ellipses are typically accepted tolerances for lamps).

In addition, brightness variation of the red, green and blue LED will also affect chromaticity and generate much higher chromaticity spread in the range of up to 30 McAdams ellipses, which for example (figure 3 B) corresponds to a color temperature range between 3500 K and 6000 K.

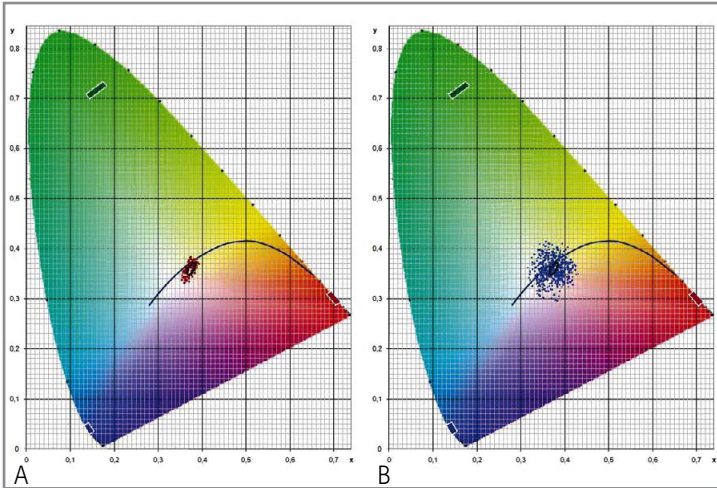

Figure 3: (A) Typical chromaticity variances for a RGB LED. The chromaticity distribution for the red, green and blue die are shown as colored bars in the corners of the diagram. Chromaticities of mixed white light (calculated random distribution from dies with equal brightness) are shown as red dots in comparison to the 5 McAdam ellipse. (B) Typical chromaticity variation and brightness variation of the dies in a RGB LED result in a wide distribution of mixed white light chromaticities (calculated random distribution shown as blue dots).

To overcome this problem extra binning or white light calibration per LED is necessary in high quality application which increases system costs and in consequence slows down market penetration.

Residential lighting

In residential lighting we find a high variety of different luminaires for living rooms, kitchens, bedrooms and adjoining rooms. Illumination levels are relatively low, often below 200 lx and also homogeneity is not very important, and often unwanted when creating different zones in the room.



Figure 4: LED downlight - 36 LED (3000 K) with total power consumption of 9 W and light output of 470 lm replaces incandescent lamp with 40 W.

Today lamps with flux between 300 lm and 3,000 lm are typically used in residential applications. Color temperatures between 2,500 K and 3,000 K are preferred. Luminaires are mostly small and design-driven. Therefore thermal management is very important in LED fixtures for residential lighting.



Figure 5: LED desk lamp (© Stefan Imhoff).

To generate the appropriate flux a couple of LEDs have to be used in a luminaire, either less LED driven at higher current or more LED driven at a lower current. Power consumption, and in consequence the temperature of the fixture are strongly dependent on the LED current as will be shown in the following example:

An LED unit generating a flux of 600 lm (which replaces a 35 W halogen bulb) was designed using a high power LED (3,000 K). In the following calculation LEDs are driven at 200 mA, 350 mA and 700 mA alternatively. In all variants the same housing was used with a thermal resistance of 4 K/W (PCB to ambient). The number of LEDs (n) to generate the desired flux Φ can be calculated as:

$$n = \Phi / (\Phi_0 \cdot f_c \cdot f_T)$$

where Φ_0 is the LED flux under nominal conditions, f_c a correction factor according to the LED current and f_T a correction factor according to LED junction temperature (f_c is taken from the LED data sheet, to determine f_T junction temperature has to be calculated from thermal resistances and power dissipation, the factor then is taken from the data sheet).

Flux efficiency decreases with increasing current, which in consequence drives the power consumption and temperature up with increasing currents. The effect is shown in figure 6 and table 1:

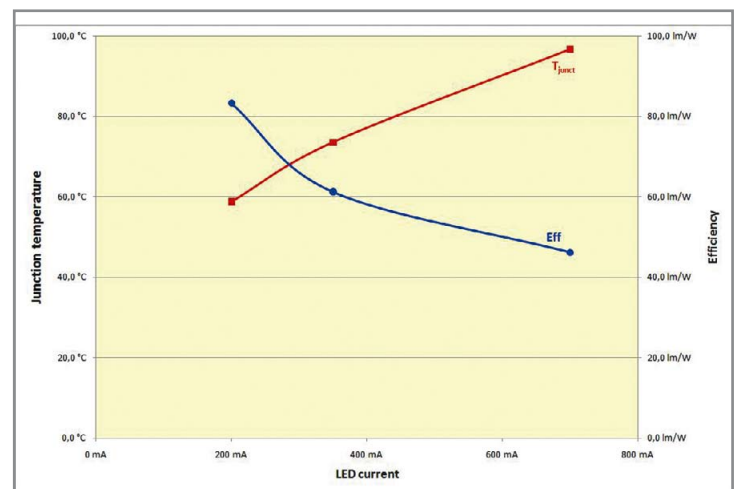

Figure 6: Junction temperature and efficiency of 600 lm LED unit as a function of LED current.

I_{LED}	n	P_{LED}	P_{tot}
200 mA	11.6	0.6 W	7.2 W
350 mA	8.5	1.2 W	9.8 W
700 mA	5.3	2.5 W	13.0 W

Table 1: Number of LEDs and power consumption for 600 lm LED unit at different LED currents. Rounding number of LED to whole numbers would lead to differences in total flux and has been omitted here for better comparability.

The downlight in figure 5 follows these guidelines exactly. 36 LEDs driven at 0.25 W each lead to manageable temperatures. A simple metal disk on top of the acrylic block is sufficient to keep temperatures at about 60°, low enough to be mounted on a wooden ceiling. Efficiency is only at 52 lm/W which shows the need for more efficient mid power LEDs.

Today, LEDs are optimized towards high power. As the example shows this is contradictory to simplify thermal management and high efficiency of luminaires as would be needed for typical residential applications. From this point of view there is a need to speed up development of mid-power LEDs (~0.5 W) towards high efficiency and low cost.

Office Lighting

In office lighting we have to deal with a wide variety of different room situations, starting from small offices occupied by one or two persons up to open space offices with 100 or more people working in it. As different as the architectural situation are also the tasks to be performed: paperwork, reading, writing, computer work, CAD, meetings and much more. Lighting these applications requires flexible lighting systems with homogeneous light distribution, relatively high illuminance levels and effective glare reduction. Most common luminaires are based on linear fluorescent lamps and use aluminum louvres or microprismatic structures for glare reduction. Light is either distributed directly to the work space (as recessed or ceiling mounted fixtures) or directly and indirectly via the ceiling by suspended luminaires for higher visual comfort.

Office lighting is within those applications with the highest requirements on lighting quality. Standards that have legal character in many countries take care that these requirements are achieved. With typical light output between 2,000 and 10,000 lm per luminaire and a glare limit of 1,000 cd/m² under flat angles, this application is a huge challenge for LED lighting.

In the following a special aspect will be pointed out: the needs regarding optical systems in office lighting. Light has to be directed towards the work space using reflectors or lenses, avoiding light to be emitted under flat angles that could generate glare. About 1% of the light being redirected by a reflective surface will be scattered in all directions – in flat angles this scattered light is perceived as distracting glare. For refractive surfaces the amount of scattered light is even higher due to beam-splitting (3–5%).

Taking into account this surface scattering, the luminance generated by a typical LED lens (diameter 25 mm) is above 2,000 – 3,000 cd/m², which is too high for typical office applications, where glare has to be limited

to below 1,000 cd/m². To meet this limit a lens has to be as large as 40 mm in diameter, a size that is not economical to be produced as a solid body any more. Instead reflectors or microstructures or combinations of both could be used. There are few luminaires using these techniques on the market (figure 7) but no optical standard components optimized for use with LEDs have been available up until now.

If mid-power LEDs (0.5 W) are used, light can be directed by lenses again. If single lenses are used, parts costs and assembly costs will be much too high. Alternatively, lens arrays with lens spacing adopted to LED spacing could be used, but again no standard components are available on the market.



Figure 7: Pendant LED luminaires for office applications. Light is emitted by 11 high power LEDs and directed towards the work space by a microstructured optical cover. Glare reduction is also performed by the microstructure.

Special designed LED optics for office lighting could also help to generate smoother light distribution to avoid multiple sharp shadows on the work space (as would be with today's small LED lenses).

Object Lighting (Spotlights)

Object lighting is used in various applications like shops, shop windows, museums, galleries etc. to highlight objects to attract people's attention. High pressure lamps (disadvantage: no dimming) or halogene bulbs (disadvantage: bad efficiency, only warm white) are used most commonly. To overcome these drawbacks LED is the right technology.

It is important for high quality object lighting to generate a homogenous, soft light distribution on the highlighted object. White light from the LED is generated as a mixture of blue light (from the die) and yellow light (from color conversion phosphors). To get neutral white light a certain amount of blue light has to be converted into yellow light. If the light from the die hits less phosphor particles, the resulting light will be more bluish, hitting more phosphor particles will generate more yellowish light.

In most LED light emitted under small angles to the optical LED axis will have a shorter path through the phosphor than light emitted under large angles resulting in bluish light close to the axis. Spotlights use optical systems that focus light emitted under different angles in a small area. Consequently yellowish light will be adjacent to bluish light generating a non-homogeneous appearance of the highlighted object.

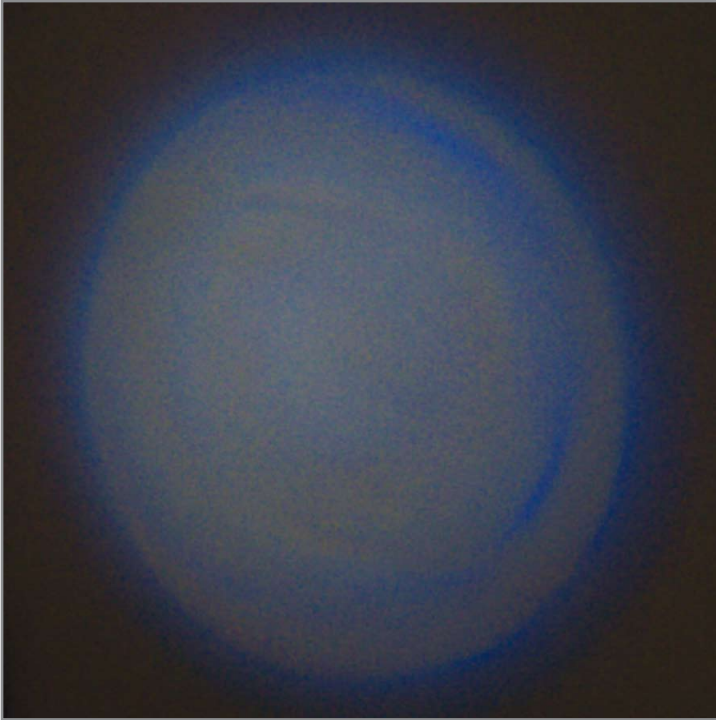

Figure 8: Beam pattern of LED spotlight with bluish and yellowish regions resulting from different light path length through phosphor

Conformal coating is a technique to cover the die itself with a phosphor coating of equal thickness. This improves color homogeneity a lot, but color differences still remain. An additional advantage of conformal coating is the reduction of the light emitting area enabling miniaturization of the optical system.

Alternatively light coming from the LED first can be mixed (diffuser, mixing optics) and then directed by the optical system. This results in better color homogeneity but also in increased size of the optical system. Integration of light mixing into primary optics and using standard secondary optics for beam shaping could be a good way to facilitate use of LED in object lighting.

Conclusion

Looking deeper into lighting applications helps to understand the needs for easy adoption of LED in general lighting. Still there are many gaps to overcome until LED are as easy to use as conventional lamps. High efficiency LED in all power ranges would reduce the challenge in thermal management to a large extent.

Tolerances in chromaticity, light output and forward voltage makes application of LED difficult often when certain requirements in homogeneity have to be fulfilled. Binning is not always the right answer as superposition of tolerances can lead to huge variations as shown with RGB color mixing.

Standardized easy to use optical systems for improved glare reduction or color homogeneity are not available on the market. Also lens or reflector arrays or optical microstructures for use in multi-LED systems could help to create LED solutions in an easier way.

To speed up adoption of LED in general lighting applications it is essential that development not only targets high power and high efficiency LED but also quality issues of the LED, high performance optical systems and improved thermal management. ■

Super High Power Infrared LED with lens



Applications:

Long-distance surveillance cameras
Medical instruments which need beam-light
Long-distance data communication system

◆ Spectral bandwidth ($\pm 3.5^\circ$)

◆ Radiant Intensity

940nm:	0.8W/sr (100mA)	4.0W/sr (600mA)
870nm:	1.0W/sr (100mA)	6.0W/sr (650mA)
850nm:	1.0W/sr (100mA)	6.5W/sr (650mA)

Alpha-One Electronics Ltd. (Japan)

www.alpha1-eg.com

„LEDs For Shop Lighting“

> Interview with lighting designer Simone Mariotto, by Arno Grabher-Meyer, LED professional

LED professional: What were your reasons for starting to apply LEDs in your lighting designs a few years ago?

Simone Mariotto: We started to use the first power LEDs in 2002, especially for accent lighting in boutiques. In these applications the customer was very interested in LEDs, not because of the costs of the product, but because shop lighting should work for at least 5 or 6 years without maintenance before the total renewal of the shop itself and they wanted to show something new. At that time the reason for using LEDs was more technical and aesthetic than commercial. LEDs solved a lot of problems which occurred with traditional light sources, like the problem of heating up the goods or the illuminated parts of furniture and textiles changing color.



Accent lighting and product showcases: LEDs solved a lot of problems which occurred with traditional light sources.

LED professional: Were there also aspects related to lighting control?

Simone Mariotto: It was important to have flexible lighting control from the standpoint of the light angle beam and the color temperature of the light. It made the job of the lighting designer more successful because he was working with these new behaviors of the LED light.

LED professional: How did you achieve flexibility from the aspect of the light angle with LEDs?

Simone Mariotto: With LEDs it was also possible to use not only symmetrical lenses but also other shapes like elliptical forms, extremely wide open lenses, or possibly radial distributing lenses. These allowed us to distribute the light around the shop better. In this way, we could distribute the light the way we needed it without wasting a lot. For example; with wall washers it is possible to have these types of optimized lenses with higher efficiencies than reflectors and without them needing to be large. At the beginning it was difficult to find the right lens manufacturer who could solve the problem of good coupling between the LED and the lens itself and at the same time produce highly efficient lenses without color effects. Today we work with lens manufacturers who handle processing high-quality lenses, even for small production orders, perfectly. This gives lighting designers a lot more freedom.

LED professional: What are the efficiency values that can be reached today?

Simone Mariotto: It is important to use high efficiency LEDs and high efficiency lenses together. Today there are low cost lenses available but the quality is not good. Some manufacturers, for example, designed lenses for an Osram LED and then used the same for a Philips Lumileds LED without redesigning it. All they did was change the housing of the lens itself. This is only a compromise then. I do not need compromises; I need optimized lenses with maximum efficiency and quality values. This is especially important for accent lighting.

LED professional: You started your work in the field of accent lighting. What about other applications?

Simone Mariotto: Now we have started to work on projects with LED lighting in malls, supermarkets and offices. A few years ago products for these types of applications had a lot of problems and were not affordable. Many architects were afraid to use LED products. They experienced a lot of problems with faulty products. Nowadays, we can also work with LEDs in the area of general lighting but it is very important to choose a quality product in terms of lighting control, thermal control and the reliability of the electronic components such as the transformers. It was especially true of manufacturers who came from the field of electronics, that they put products on the market that were weak in the areas of optics and thermal management. Products which were expected to work for 50,000 hours failed within 5,000 hours after being installed. This was a very big problem for the start of LED in general lighting.

LED professional: What projects you have worked on in the field of general lighting?

Simone Mariotto: The first project I worked on in general lighting was for a retail shop. It was a high-level fashion boutique in Naples in the year 2004. We used 3,400 K2 Philips Lumileds for a sales area of 800 square meters. With these products we managed to reach a general lighting level of about 400 lux on the floor and approximately 1,200 lux on the vertical surfaces. It turned out to be a good contrast with beautiful lighting effects. It is important to know that the LEDs were not only used to halve consumption, but they were also used to solve architectural problems. In this shop the customer wanted all of the lighting integrated in the ceiling but we only had 5 cm of ceiling space to use! In the end, we developed a special LED recessed lighting system which fulfilled all of the requirements and which could not be surpassed based on any traditional light source.

The shop has been open for four years now and up until today and we have had only 50 LED sources that have failed. That's less than 2%. This shows that the life span of LED lighting is really very long, when it is designed well.

We can say that most of those faulty sources were damaged by poorly done thermal coupling between the LED and the heat sink because it was a hand-made operation.

Imagine...

the World's First SMT Lamp

Your Imagination: 100,000 travelers rushing through an airport on a holiday weekend looking for an easy to read sign to locate their departure gate.

Our Innovation: Avago Technologies delivers the World's First SMT LED High Brightness Lamp designed for outdoor full color signs.

By allowing designers to utilize both sides of a PCB, our surface mount lamps allow for thinner, lighter signs while enabling pick and place assembly resulting in faster cycle times.

If a commitment to technical excellence and innovative solutions on Signs and Signal applications is critical to your design, contact Avago for a free sample.

www.avagoresponsecenter.com/317



AVAGO
TECHNOLOGIES

Your Imagination, Our Innovation



Even in 2004, LEDs allowed for an exclusive, beautiful light in fashion boutiques - even if space is limited - providing the advantage of reduced energy consumption.

LED professional: What was the power source of the LED in this project?

Simone Mariotto: The LED current was designed for 700mA. But we also designed the complete fitting taking the thermal management into account - that it wouldn't reach more than 60°C for the LED heat sink.

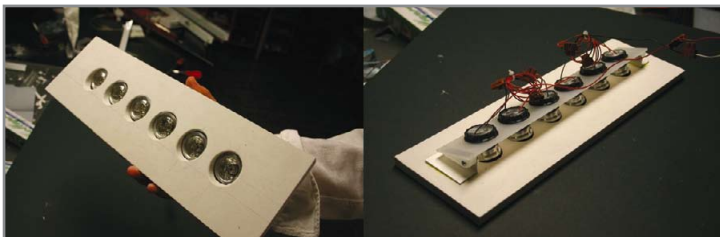

The low profile LED fittings were designed to fit into a cavity just 5 cm deep while keeping the LEDs satisfactorily cool.

LED professional: What about the energy savings in this project?

Simone Mariotto: We have reached a power consumption of about 30% compared to what we would have had with traditional light sources.

LED professional: What about replacing failed LEDs to achieve the same light quality?

Simone Mariotto: The lighting system is designed to replace any single LED out of the matrix including the heating and lens. Most of the products today do not allow us to re-lamp a luminaire. But nevertheless, there is still the problem of having the same binning and color temperature that we had at the time that they were ordered.

LED professional: What are the major benefits for the customer in shop lighting when using LEDs?

Simone Mariotto: The customers are not only interested in cost savings, but they are also interested in aesthetic issues and communication topics. They want to show that they have something new. On the other hand, customers that are in the supermarket business are mainly interested in the cost savings.

In a specific project for a mall they used 300 luminaries with four fluorescent tubes, L55W with about 75,000W. Replacing them with LEDs reduced power consumption to 94 W - less than a third of the old system and with the same amount of light output. And furthermore, think of all the maintenance problems when the luminaries are at a height of 5 to 6 meters. So we have to take the overall costs into consideration.



Today, LEDs allow even general lighting in supermarkets without compromising light quality.

LED professional: Are there areas where you would not use LEDs nowadays?

Simone Mariotto: Maybe in some areas of street-lighting when replacing HID with LEDs. But the combination between LED and solar energy is very interesting, on the other hand. Another application where it doesn't make sense to use LEDs at the moment is when extremely high lumen output values are needed - like in stadium lighting. In general, the customer has to understand that the buying costs are higher, maybe twice or four times higher, but the overall performance will pay back.

LED professional: How much are you affected with binning issues in your work?

Simone Mariotto: The major issue is to have small tolerances in the vertical axis of the color diagram. The future LED should work very close to the ideal white line. But in any approach we should have the needed cost reduction in mind.

LED professional: What developments do you expect in LED lighting in the near future?

Simone Mariotto: The market for luminaries with LED is expanding. But not in the way it could grow. Today the major LED producers are the same manufacturers as those that produce, for example, fluorescent lighting products. They could have business problems if the transition to the new LED products is too fast. In comparison to the IT sector where there was an exponential growth rate at the beginning, the LED growth rate is lagging due to the commercial obstacles I mentioned. Standardization is also a topic because when designing an LED product you are more or less stuck with a specific technology and a producer that is not able to vary between LEDs easily. I hope that we will have standardization especially for the packaging and for the electronics as well as for connecting the lenses. At the moment it is also not possible to compare data from different manufacturers. Here, we need a uniform way to measure and publish data.



LEDs have also several advantages if used for lighting artwork.

LED professional: What about OLEDs?

Simone Mariotto: OLEDs are very expensive and the efficiency is too low. OLEDs need big surfaces and end up having a lighting effect indoors like you have outdoors. This is not comfortable from my point of view and in terms of energy efficiency – OLEDs distribute light in general where in terms of efficiency we should focus the light where we really need it. The general lighting level should be as low as possible. With efficiency values as they are now, OLEDs are only used for decorative lighting. But this is only my opinion.

LED professional: Simone, thank you very much for this interesting interview and giving us an inside view from a lighting designer.

Simone Mariotto: Thank you. ■

About Simone Mariotto and Liteq Design:



Simone Mariotto, founder of Liteq Design, has profound experience in planning and realizing lighting concepts and in designing and engineering lighting products.

His company has elaborated and installed the lighting concepts for boutiques of some of the most important high level fashion firms in the world.

After receiving a university education in lighting engineering, Simone started his career at iGuzzini. Having collected experience in technical lighting design, Simone founded Liteq Design together with his partner Giorgio Brambilla.

Liteq Design focuses on lighting design and product design. The team has realized hundreds of projects in Europe, the United States, and the Middle and Far East. Liteq Design has developed many tailor-made lighting fittings for meeting highest technical design standards. Many of these fittings today are part of the product catalogues of leading European lighting companies and are the result of the extensive research and development activities of Liteq Design.



StellarNet Inc

LED MEASUREMENT SYSTEMS

Watts/m² μWatts/cm²
 LUX, Lumen, PAR
 CRI & CQS
 xy chromaticity
 Dominant Wavelength
 Purity, CCT
 NIST traceable



LED Measurement Systems

StellarNet offers a complete line of low cost LED test and measurement systems covering the 200-1700nm range. All instruments are NIST calibrated to measure the absolute intensity, complete with a line of integrating spheres ranging from 2" to 20" in diameter. These systems offer rugged, high performance measurements by utilizing shock-proof enclosures and permanently aligned optics to suit all of your LED measurement needs.

www.StellarNet.us ★ ContactUs@StellarNet.us ★ (+1) 813 855 8687

Addressing the Rising Requirements for Solid State Lighting Products

> Mitch Sayers, Field Applications Engineer, Cree Europe GmbH

One can't attend a lighting show or stroll the lighting aisle in the home improvement store and not know that LEDs, for general illumination, have arrived. News of increasing efficacy and ever-growing numbers of applications using LEDs shows us that this technology is no longer a niche or a secondary option confined to exceptional products. As fewer and fewer lighting manufacturers have yet to introduce LED-based products, the pressure to have an offering using LEDs is increasing. Aside from the differences that one might have for the up-front acquisition costs of LED-based products when compared to similar conventional light sources products, there are a few complicating factors: managing multiple light sources, increasing levels of electrical content, numerous variations within a given product type and the need to master the thermal and optical aspects of LED lighting systems. With these complexities, many potential users continue to seek a simpler way to implement LEDs in order to take full advantage of the technology.

It goes without saying that different LED applications have different priorities. For example, street lighting applications have a very primary need for efficacy but also for high lumen maintenance, making an outdoor white XP LED optimal. Yet an indoor retail lighting demands high color rendering in addition to efficacy. In this particular situation, e.g. a warm white MPL Easy White LED can fit perfectly (figure 1).

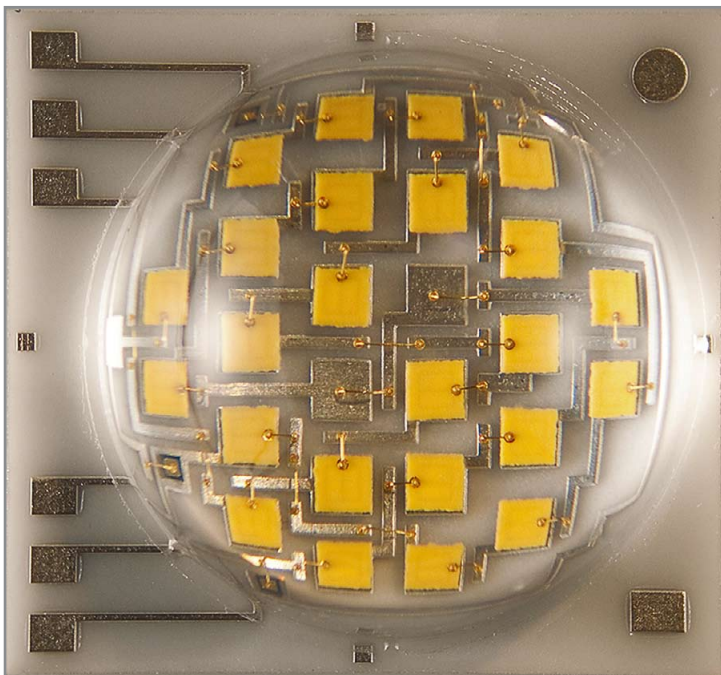

Figure 1: Cree's MPL Easy White LED is one example for a new generation of LEDs for indoor and shop lighting, offering high CRI, narrow binning and appropriate CCT.

Taking the perspective of differing needs a step further, most applications for general lighting require the high level of performance and stability that are offered by lighting class LEDs, such as the XLamp family of LEDs. Other applications, like for example, in consumer electronics or very low-end flashlights, are positioned in a price-function market where lighting class LEDs are not needed or desired, but where low-cost components that offer consistent binning are better suited. LED manufacturers have been working diligently to address these application-specific needs to deliver on the promise of LED lighting.

The first area of need is lighting performance, best measured in lumens and lumens per watt. Higher output per area of chip, as well as size and numbers of chips has increased the overall lumen output of what is an increasingly loose definition of an "LED", ranging from traditional PLCC-type devices with a few lumens to metallic or ceramic substrate bolt-down or glue-down devices with hundreds of lumens. Efficacy is at the heart of the value of LEDs, isolating power efficiency to produce given quantities of illumination to applications, expressed in lumens-per-watt, lm/W. Here, the industry has held closely to the projections made several years ago under the auspices of the U. S. Department of Energy (figure 2).

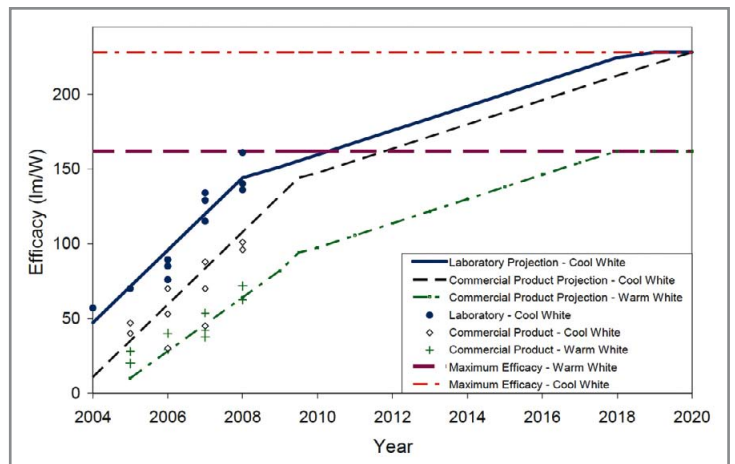

Figure 2: The industry has held closely to the projections made several years ago under the auspices of the U.S. Department of Energy (CW and WW efficacy, lab and commercially available with theoretical boundaries).

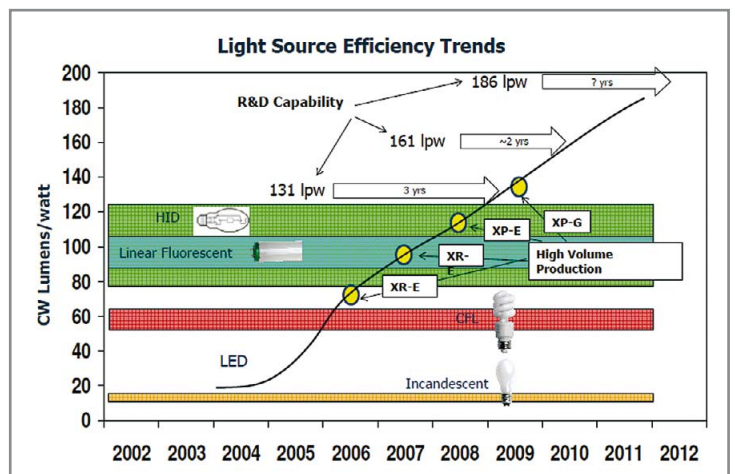
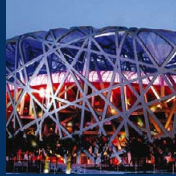

Figure 3: LED manufacturers made continuous improvements and will continue to do so, as can be seen in the range of Cree's XLamp family.



CREE. SERVING UP MILLIONS OF 100+ LUMEN XLAMP® LEDs. THAT'S LIGHTING-CLASS.

Built to deliver energy-efficient beautiful light, Cree XLamp LEDs outperform all others in brightness and efficacy. And they prove it daily at thousands of commercial, architectural and residential installations worldwide.

Contact a Cree Solutions Provider or authorized distributor at www.cree.com/xlamp or call 800-533-2583.



XLamp XR-E
The proven platform.
Up to 114 lumens
at 350 mA.

XLamp MC-E
Up to 456 lumens
at 350 mA —
4x the flux, same
size as an XR-E.

XLamp XP-E
Same output as
the XR-E at 20%
the package size.



Join the LED Revolution and visit Cree at L+B Hall 4.2 G71
and at LightFair Booth #149 or online at CreeLEDLighting.com.

This wide range of luminous-flux-per-device provides the flexibility to address applications ranging from linear niche lighting requiring just a few lumens per device to replacing a 75-Watt halogen bulb with a single, high-power multi-chip LED, like the MPL Easy White LED. This trend will continue as LED manufacturers optimize solutions for solid state lighting (SSL) products, through different packages and chip configurations as described above, as well as improvements in chip efficacy and current capacity and phosphor efficiencies (figure 3).

Yet beyond lighting performance, there are a number of other factors that can make LED implementation difficult, which have received significant attention and efforts in coordination. The first is color binning. Initially, "monochromatic" or narrow band emission LEDs were simply grouped by dominant wavelength or peak wavelength in some cases. This seemed to satisfy the needs for most applications, and indeed still does. Yet since their creation, the binning of white LEDs has been largely driven by each different manufacturer in slightly different directions. No two binning schemes were exactly alike. Incandescent light sources never displayed variations in color and never had to be "binned". However through the basis of binning and SDCM (Standard Deviation of Color Matching) color space definition used in the fluorescent bulb and tube industries, standards have been created, such as the ANSI 78.377A standard used in the US (figure 4), which forms the basis for the Energy Star standards for solid state lighting lamps and fixtures. This gave rise to the definition of a set of parallelograms that follow the Planckian (black body) curve throughout the white color space in the CIE 1931 color diagram.

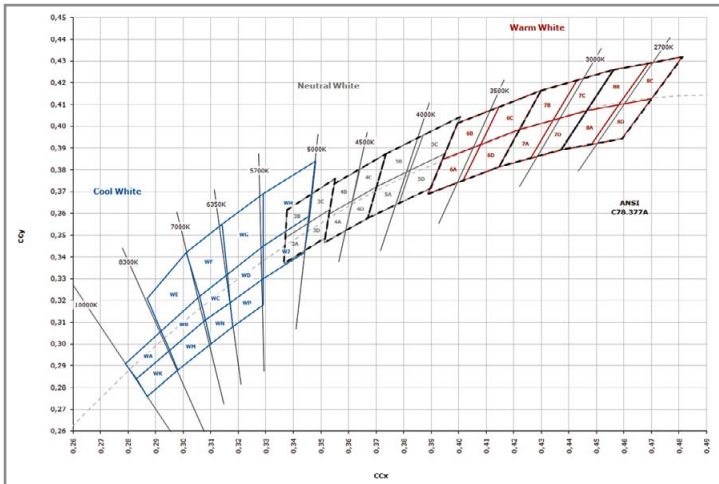

Figure 4: The ANSI 78.377A Standard (a) was originally created for fluorescence tubes and now is the basis for the SSL-bins of the Energy Star standards, leading to the ANSI Color Bins along the Planckian (black body) curve throughout the white color space in the CIE 1931 color diagram.

Beyond just establishing relatively large CCT groups in the ANSI standard, manufacturers adopted these as a basis for binning, these color regions have been broken down into smaller groups (e.g. 4 then 16) and are now more targeted by combining the phosphor with chips in order to provide a higher level of color control to lighting module and fixture manufacturers (figure 5). For example to mix LEDs in multiple-device fixtures to achieve overall color ranges imperceptible to the eye. While these smaller bins

still differ slightly today, it is very likely that these subdivisions will become aligned within the next couple of years. In some cases, the need for color binning can be eliminated entirely by creating an overall color range comparable to that of fluorescent tubes through products like the EasyWhite MC-E and MPL LEDs (figure 6). This can serve to further reduce complexity and overall cost.

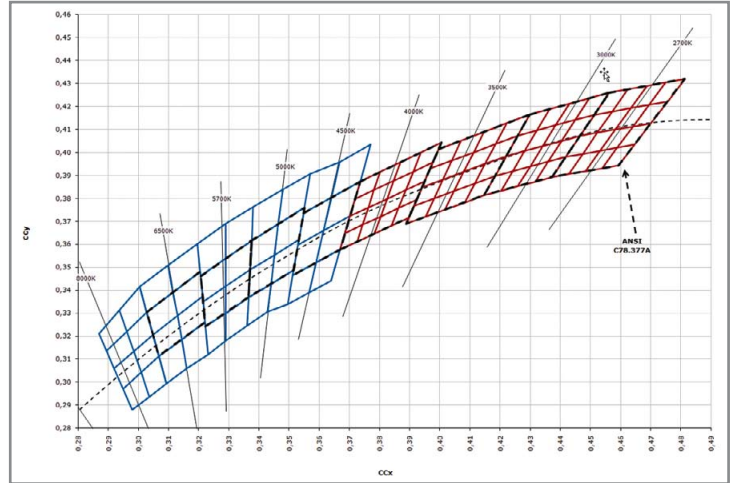

Figure 5: Cree ANSI Bins for XP platform - The ANSI standard has been broken down into smaller groups.

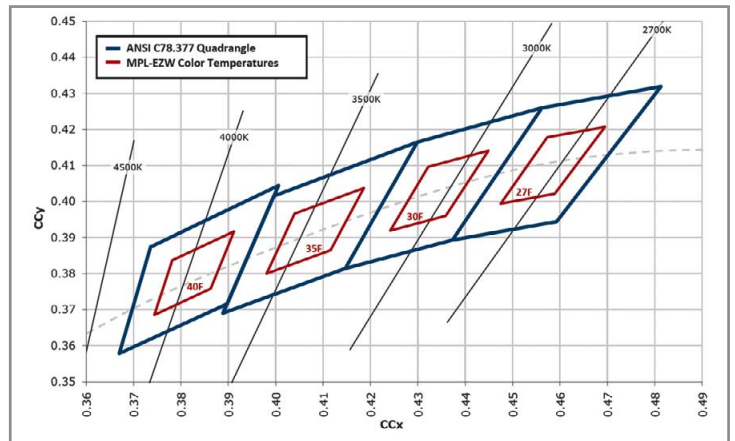

Figure 6: The need for color binning can be eliminated by using newly designed LED products (Easy White Binning).

Other areas of binning - flux and forward voltage for example - tend to be somewhat simpler to manage, although there are differences and continual shifts in them. Further, these can be compensated through adjustment in the power supplies used to drive the LEDs. Flux bins can be compensated via forward current within the specified limits, but should still be small respective to the total rated flux (e.g. less than 10%). Forward voltage is generally only significant where inexpensive voltage-control systems are used to drive the LEDs. Therefore these have not required the same attention as color binning has received recently.

Also important has been establishing a uniform way to measure the stability of performance over the life of an LED. The potential lifetime of LEDs, especially relative to incandescent and fluorescent light sources led many to begin to quantify the benefit. However, there were no uniform standards by which to base these claims. A 50,000+ hour lifetime is often claimed by anyone using LEDs in their lighting product,

although it's very clear that a large portion of these products performed nowhere near to this level under normal operating conditions. This is still evident to a large degree in hardware stores, supermarkets and electronics stores offering LED-based replaceable lamp products, where large numbers of radial 3- or 5-mm LEDs are used, which often become unusable after a few hundred or thousand hours, providing almost no benefit over the light sources they are replacing. In recognition of this great disparity among LED lighting products being offered, many standards bodies have worked diligently to create performance criteria for SSL products and to define operating conditions, measurement methods and performance criteria to more precisely describe performance stability. This is now termed "lumen maintenance," or the ability of a lighting product to maintain its lumen output. Until recently, lumen maintenance had been analyzed as a function of the forward current passing through an LED, as well as the temperature in the LED chip, or junction temperature. Today, most LED manufacturers are testing lighting class LEDs for 6,000 - 10,000 hours (8- 14 months) and beyond in order to better predict how the LEDs will behave during the lifetime of the fixtures into which they are being integrated. The standards included in the Energy Star requirements in the United States, as well as listings like that of Underwriters Laboratories (UL) help to ensure standards, and while not legally regulated in Europe, do serve as a significant reference point if not a de-facto means of determining SSL quality until standards are in force within the EU.

An additional area of focus has been light quality, primarily quantified since the mid 20th century by color rendering index (CRI). While other measurement systems are currently being developed, CRI does provide a means of determining a light source's ability to fully illuminate all colors of the visible spectrum. Up until the last few years, even fluorescent and discharge light sources often had poor color rendering compared to incandescent light sources. LEDs have picked up where these light sources have left off by providing relatively continuous spectra of emitted light, and continue to improve to levels approaching incandescent light sources. Yet many readily commercially available LEDs and LEDs being placed into mainstream SSL applications today have CRI levels similar to the fluorescent light sources from two decades ago. As LED efficacies continue to increase, surpassing various thresholds for power consumption and LED device usage and cost, light quality has received more attention in certain applications. As LED efficacy begins to exceed that of any other commercially available light source, more emphasis will be placed on light quality, which often comes at a rather significant efficacy cost. Yet at the same time, the efficacy requirements being placed by legislative bodies around the world on SSL products continue to increase, keeping more focus on efficacy than quality of light.

Lastly, when the discussion of SSL lighting turns to the adoption rate of LEDs in the overall general lighting industry, the focus quickly becomes cost. The most suitable way of describing LED cost tends to be by light output per unit cost, or lm/Euro. Many times application requirements for lumens from LED sources will differ from those for traditional light sources due to the higher optical efficiencies achievable.

As a consequence, lm/Euro will not completely describe a comparison between LEDs and other light sources in determining advantages and payback durations, but rather the application cost. However in most cases the relationship between lumens and fixture requirements is too complex to apply across different applications. Therefore, taking a step back to lm/Euro allows for a broader comparison and measure of the progress in the LED industry for planning application by product type. This measure of cost-effectiveness can be improved by increasing LED output while maintaining cost or by reducing cost of the system itself. The LED output side of the equation runs counter to that of LED efficacy: the higher the forward current through the LED, the more light output and therefore the more lm/Euro, however the lower the efficacy in lm/W. These two forces, cost and efficacy, tend to balance each other to determine the forward current appropriate for a given application. Yet products like the XLamp XP-G re-set the boundaries by providing industry-leading efficacy, even at the highest specified drive currents of any device in its class. This allows for new levels of cost effectiveness. Yet the cost in an LED package has also evolved from engineered products to devices that are much simpler, but equally effective in extracting light and dissipating heat (figure 6).

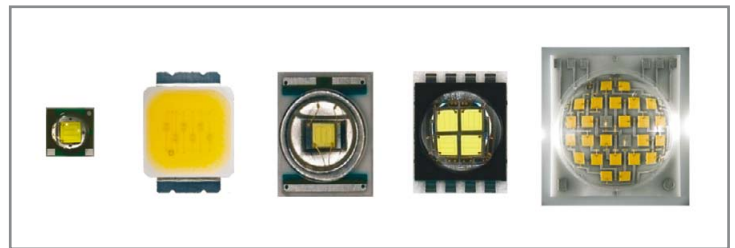

Figure 7: Examples of improved LED packages - and as a next logical step, a LED Lighting Module - allow for a more convenient and easy luminary design.

If these steps are not enough for a lighting fixture manufacturer to make a start into solid state lighting, then all of these can be rolled along with higher levels of performance by utilizing a module, where a "black box" light source can be designed into a lighting fixture, with great ease: supply wallplug power, access to cooler ambient air and an unobstructed path for the light to be emitted and the product can already take form.

With these developments taking place on a wide scale in the SSL industry, LED applications are becoming easier and SSL products are improving in function and quality. While European standards are still in the relative early stages of definition and enforcement, the ever-steadily increasing efficacy and improving color control in better suited packages continue to improve the quality of available SSL products to propel energy-efficient, environmentally friendly lighting solutions into the farthest reaches of the industry. ■

OLED Technology – Status of a Promising Lighting Solution

> Siegfried Luger, LED professional

OLEDs are the next step forward in the evolution of Solid State Lighting (SSL) technology, which generates light by semiconductors, rather than using a filament or gas. SSL lighting provides illumination that is more energy-efficient, longer-lasting and more sustainable. It also opens exciting new doors to how we can use, integrate and 'play' with light in our homes, cars, shops and cities.



Figure 1: Dynamic OLED display wall.

LEDs and OLEDs – The Difference

LEDs and OLEDs both generate light by semiconductors – basically by stimulating electrons in their components with an electrical charge. They also share the ability to create color effects that go beyond the ability of incandescent lamps. They both share the potential to become extremely energy saving light sources. But there the resemblance ends. There are a number of differences between LEDs and OLEDs in their make-up, the type of light they produce and the way they can be used, complementing each other in terms of the application used.

Organic vs. Inorganic – Another Type of Light

A key structural difference is that OLEDs are created using organic semiconductors (such as those that make up organic solar cells), while LEDs are built in crystals from an inorganic material. There are also visible differences between these two types of solid-state lighting. LEDs are glittering points of light – in essence, brilliant miniature bulbs. OLEDs, on the other hand, are extremely flat panels that evenly emit light over the complete surface. The illumination they produce is "calm", more glowing and diffuse, and non-glaring. The thin, flat nature of OLEDs also makes it possible to use and integrate light in different ways than LEDs can do – or any other lighting source for that matter. LEDs are excellent to create sharp beams, add drama and accent due to their compactness. OLEDs will never replace LEDs – they have their own very specific and useful types of application possibilities. The two, however, complement each other very well, providing different options in a new type of digital lighting that is becoming increasingly important in an energy-conscious world.

How OLEDs Work

OLED lighting works by passing electricity through one or more thin layers of organic semiconductors (see figure 2). These layers are sandwiched between two electrodes – one positively charged and one negatively. The "sandwich" is placed on a sheet of glass or other transparent material which, in technical terms, is called a "substrate".

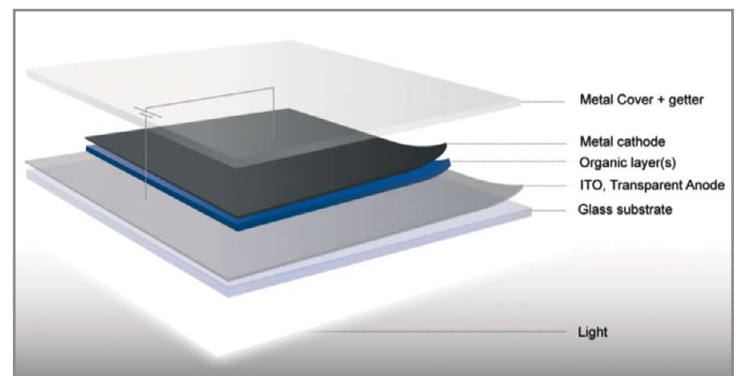

Figure 2: Structure of an OLED.

When current is applied to the electrodes, they emit positive and negatively charged holes and electrons. These combine in the middle layer of the sandwich and create a brief, high-energy state called

RAGNI Objective...Energy conservation...



OPUS® & OPUS® - Optical led - LECOOLOR bleu



Design by
PORSCHE DESIGN
STUDIO

LED

RAGNI has a keen interest in serving the needs of markets focused on reducing public expenditures and favourably responding to sustainable development while complying with its customers' requirements. Indeed, a so-called "economical" source must have a pay back over its entire lifespan. Otherwise, it is of no interest.



Luminaire R-LED

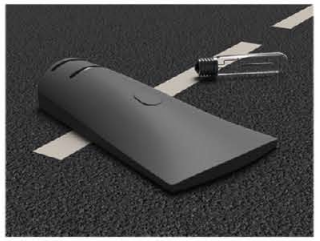

Luminaire R-LED-S

R-LED & R-LED-S
Miniaturised luminaires cast in magnesium, an alloy that requires little energy in its production.. Technology in a more conductive and more resistant innovative material, the body of the luminaire serves as the heat sink enabling thermal regulation of the LED source. We refer to it as "grey energy."

LED Optical Blocks - The OpticalLED replaces the symmetrical or asymmetrical road reflector. This monoblock module is comprised of a high-efficiency optical system that is thermally secured. Low consumption, Instant ignition, choice of light quality, 3200, 4200 and 6000°K. Over 90% recyclable. Contains neither lead nor mercury and only 25.1 kg of CO2 per year.



“excitation”. As this layer returns to its original, stable, “non-excited” state, the energy flows evenly through the organic film, causing it to emit light (brightness values see figure 3). Using different materials in the organic films makes it possible for the OLEDs to emit different colored light.

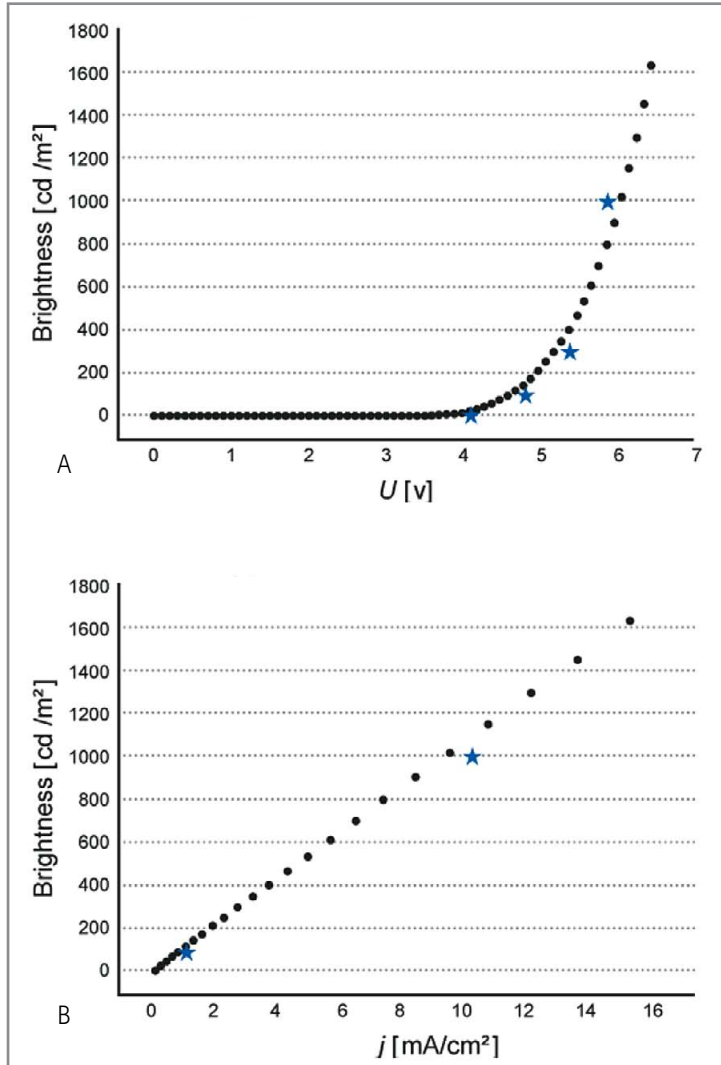

Figure 3: Brightness of an OLED stack as a function of the source voltage (A) and the current density (B).

Light Impression

OLEDs already offer unique characteristics and capabilities that can redefine lighting, and the way we use and experience it. First, there is the subtly diffused – almost magical – nature of the illumination itself. OLEDs create soft glowing clouds of light, rather than bright rays. Then, there is their homogenous output, unusual appearance, low heat emission, extremely flat nature and high degree of controllability. These offer designers, artists, architects and others great freedom in creating groundbreaking new lighting concepts and experiences: ones that will greatly appeal to consumers by making it possible to change the atmosphere in a room in dramatic and unexpected ways.

OLEDs Tomorrow

We can expect to see designers, architects and consumers increasingly using OLEDs in a variety of contexts over the next few years. This, however, is just the beginning. Research and development continue at top speed, conquering new and unexplored territory. Imagine ceilings glowing with color, glass walls that light up at the wave of your hand, or windows that provide subtle illumination after dark. The result is large areas of evenly distributed light that can be adjusted in brightness and color and can be applied to almost any surface in almost any shape. This is the exciting world of the OLEDs of the future (see figure 4 and tables 1 and 2).

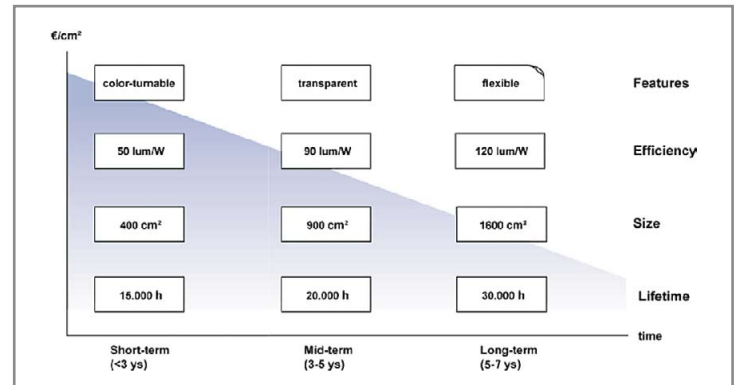

Figure 4: OLED roadmap from Philips Lighting.

Feature	Benefit
Thin	Less space needed in application: design freedom
Low weight	Ideal source in weight sensitive application
Diffuse low brightness source	No glare and soft light effect
Energy efficient	Today at par with halogen – future 140-150 lm/W
No harmful substances	Environmentally friendly Easy to recycle
Low voltage	Safe in use

Feature	Benefit
Color tunable	With the use of different colored OLEDs dynamics are possible
High CRI	Opens a wide range of applications
Transparent and flexible light source	Integration – Unusual designs Invisible light source in off state

Tables 1 & 2: Benefits of OLED lighting today (above) and in the future (below).

Beyond Illumination

The OLEDs currently available are mounted on glass. So far, glass is the only transparent substrate that sufficiently protects the material inside from the effects of moisture and air. However, scientists are investigating ways to make soft plastic substrates that will provide the necessary

protection. This will open the way for flexible and moldable OLED lighting panels, making it possible for any surface area – flat or curved – to become a light source. We could see the development of luminous walls, curtains, ceilings and even furniture. Flexible OLED panels are likely to become available within 5 to 8 years (see figure 5).

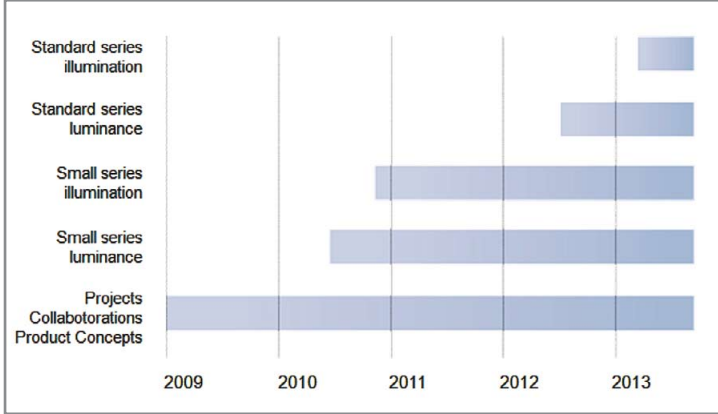

Figure 5: Availability of OLED products from Philips Lighting.



Figure 6: Glow – an interactive and dimmable OLED light source from Philips Lighting.

Conclusion

With the massive research investments going on, it is clear that over time OLED lighting technology will develop to the next stage and will become ready for the lighting market. Especially when long living phosphorescent blue emitters are found, efficacies of over 100 lm/W should become technically feasible. But then the most challenging part for OLED lighting still has to come: the end-user market acceptance. This requires good products, fast standardization and good communication. ■

Acknowledgement:

Pictures courtesy of Philips lighting.



Universal Portable Light Meter



Jaz
does
it all!!

Lumen
Lux
PAR
CRI
CIE
CCT



UK: +44 1865 263 180
 Germany North: +49 513 697 467 05
 Germany South: +49 711 341 696 0
 France: +33 148 576 136
 Austria: +43 226 220 673
 Other: +31 26 3190500

www.oceanoptics.eu

LED Retrofits for Antique Style Roadway and Walkway Lights

> Heather Goldsmith, Future Lighting Solutions

LED retrofits are always an engineering challenge, but Hadco Lighting faced unusual complexities in developing an LED upgrade for its widely deployed family of HID post top fixtures. Tens of thousands of refractive globes installed on roadways and walkways through North America, the company needed an LED light engine that could not only direct light properly through the globes' distinctive prisms but also be quickly swapped on-site with the original HID assembly. Future Lighting Solutions engineers helped to build a replacement module using LUXEON® Rebel LEDs from Philips Lumileds. Today, the result, LumiLock™ LED retrofit, fills the optical bill while also enabling road crews to convert HID post tops to LEDs in a matter of minutes.



Figure 1: The refractive post top fixtures are installed throughout North America. Switching from HID to LED illumination must be done on-site without rewiring.

Upgrade With A Twist

The goal of the project was to provide an easy transition from traditional HID sources to 'greener' LED technology for municipalities, utilities and commercial developers using the Fentress Refractive Series of post top fixtures. The switch would reduce power consumption by 55 to 60%, while also providing a typical 14-year lamp life that would eliminate the costs associated with replacing HID bulbs every 48 months.

To accommodate the vastly different LED shape and technical requirements of solid-state lighting, a replacement for the integrated ballast and socket module at the heart of the fixture was designed. The new LumiLock LED module replaced the original HID lamp with four rectangular 'light bars' housing one or two 10-LED boards each, but retained the patented 'twist-lock' mechanism for tool-less disconnect and reconnect of the wiring system. That mechanism - previously developed for easy relamping of the HID post tops - would now permit easy installation of the LED upgrade.

With no LED board designers on staff, outside help to develop the solid-state lighting assembly itself was sought. "We were facing complex decisions on everything from LED selection and board configuration to

optics, thermal management and even selection of the board manufacturer," said Michael Riebling, Hadco Solid-State Lighting R&D Manager. "It was a project that had to be handled with a team that specializes in LED application development."

Refraction Action

After analyzing the system requirements to recommend the best power LED for the job, the team quickly zeroed in on the cool white LUXEON Rebel product for several reasons. The Rebel's ultra-compact footprint would allow tight clustering on each 10-LED board for optimal positioning on the LumiLock module. It also had the ability to withstand higher drive currents and elevated junction temperatures without sacrificing lifetime or reliability, and it offered a minimum 100-lumen part that would deliver needed light output with the fewest emitters to minimize costs and board real estate.



Figure 2: The refractive prisms (left) - originally designed for the HID LumiLock module (centre) - create a distinct light distribution pattern that had to be considered in developing a quick-swap LumiLock LED retrofit (right).

Next, optics experts performed a series of optical simulations to determine how best to replicate the light distribution of the original HID lamp. The refractive prisms on all the globe shapes are cut for a 360-degree metal halide light source, bending the light horizontally for maximum coverage, minimum light trespass, and glare control as well as shadow reduction. Future's challenge was to develop a board design that filled the globe with light to provide similar refraction capabilities with the directional LED beam.

"It was a question of doing optical modeling to determine where the LED arrays needed to be positioned on the LumiLock module and on the boards themselves to deliver HID-equivalent optical performance," said Michael Quijano, Optical Design Engineer for Future Lighting Solutions. "We knew we needed to cluster the LEDs toward the center of each light bar so that the light would be coming from roughly the same location as the HID bulb, but even moving the array 1 or 2 mm up or down altered the effect."

Heat, Light & Lifetime

With the optical simulations completed and several scenarios provided to choose from, the work torch passed to the thermal and electrical engineers.

Using proprietary software, the team turned its attention to determining the most appropriate drive current to ensure optimum light output and life span. Exclusive tools were also used to calculate the expected luminous flux of various combinations of drive current, ambient temperature and heat-sink thermal resistance levels, as well as to provide thermal guidelines to develop a custom heat-sink. This made it possible to evaluate alternative designs with accurate LED modeling - requiring no prototyping that would slow down the design process - and thereby optimize the performance of the final light engine.

In addition, the engineers calculated the expected lifetime of the LED system based on the LED model, drive current and junction temperature specified in the proposed design. The analysis predicted that the design would provide a minimum 50,000-hour working life at 70% lumen maintenance - precisely the goal outlined in the design criteria.

Mission Accomplished

The final design turned out to be more versatile and flexible than even Hadco had imagined. The same four-light-bar LumiLock LED module, for example, is able to provide an LED retrofit for both, the 100 W and the 175 W metal halide post tops simply by utilizing one or two 10-LED boards per light bar, respectively. The same basic module also fits narrow and wide globes with only minor manufacturing changes. This in turn simplifies production and inventory management. "Our distributors have to stock only four LumiLock LED SKUs to cover all of our non-glass refractive post tops - one- and two-board versions for narrow and wide globes," Riebling noted.

In addition, a patent-pending bracket system permits rapid conversion from symmetric to asymmetric light distribution or vice versa simply by unscrewing and reorienting two of the module's four light bars. This eliminates the need to change globes or use a house-side shield for different illumination patterns.

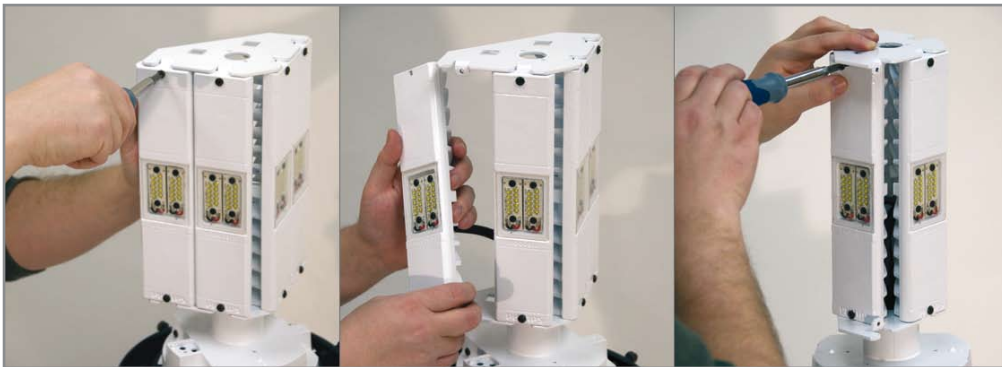

Figure 3: Converting the module from asymmetric to symmetric light distribution for different environments is as simple as 1-2-3.

With that initial project completed, the team of designers began the process of building LUXEON-based LED retrofits for the rest of Hadco's post top line. Eventually, the company expects to offer LED replacements for virtually every post top fixture in its catalog, ideally using the same basic module design for every globe offering in the entire line to help fixture owners reduce energy costs, prolong lamp life, and lower the total cost of ownership. ■

Gosoled Lighting

www.gosoled.com

GOSOLED LIGHTING CO., LIMITED

- ◆ Dimmable led light pioneer, optimized manufacturing techniques
- ◆ Customer-specific, machining, modifications and special design

Dimmable LED Light Series

Suitable for a variety of conventional dimmers (TRIAC, adjustable Front edge and trailing edge dimmer)

LED Modular Light Series

Easy-to-maintain modular design, all of all make the lamps achieved applicable of modular, standardization and Seriation.

Mg-Al alloy LED Cabinet Lights

Mg-Al alloy material heat dissipation efficiency is above 2 times to the die-casting aluminum.

LED Light Tube Series

Use the arcuated PCB design, 180 degree swivel, High-Transparency PC Cover, a more convenience application.

LED Driver Series

Driver Outside, Driver Inside, Dimmable LED driver.

TEL: +86(755)8350 0557
FAX: +86(755)8350 0556
E-mail: info@gosoled.com

Technology

High Quality GaN Substrates for Modern LED Technology

> V.E. Bougrov, A.R. Kovsh, M.A.Odnoblyudov, CJSC "Optogan" and A.E. Romanov, CJSC "Optogan" and Ioffe Physical-Technical Institute RAS

It is well known that modern III-nitride based technologies for light emitting diode (LED) production include (as an initial inevitable step) the preparation of GaN templates. Such GaN templates are usually delivered on foreign substrates possessing high lattice mismatch with respect to GaN layers, e.g., sapphire or silicon carbide substrates. The growth of GaN layers on highly mismatched substrates occurs via the formation of 3D islands with their following coalescence [1]. Such growth mode results in an extremely high density of threading dislocations (TDs) up to 10^{10} – 10^{11} cm⁻² in the layer interior [1]. These TDs are known as main sources for the deleterious performance of LEDs and other GaN based electronic and optoelectronic devices [2]. Therefore there exists an ultimate necessity in the developing of effective and low-cost recipes for low TD density GaN template manufacturing.

A number of important techniques for TD density reduction in GaN templates has already been described in literature. For instance, these techniques include: the introduction of a low temperature nucleation layer before high temperature growth, preliminary substrate nitridation or application of antisuifant dopants, use of strained interlayers and superlattices, growth of thick buffers, and different variants of the lateral overgrowth technique. For an overview of the existing methods for TD density reduction in GaN layers together with a concise bibliographic list, see Ref. [3]. However, the above mentioned techniques are either not very effective or rather expensive.

The present article describes an effective approach developed to reduce TD density in growing GaN layers by in situ adjusting the growth conditions. Starting point is a physical model which describes the TD density evolution in growing III-nitride layers. Then the experimental evidence of the TD reduction in GaN templates will be provided. Finally, additional technique, which is related to the improvement of template quality by the diminishing of the level of mechanical stresses are discussed, and the role of the advanced approach in the line of other OptoGaN technologies is highlighted.

General Physical Approach

In general, there are three possibilities to control and reduce TD density in growing mismatch layers: to prevent TD generation, to move TDs away from the interior to layer sides (e.g., to the edge of the wafer), and to facilitate reactions among TDs [4]. When considered separately, all the above possibilities can be hardly realized in (0001) grown nitride

layers. The nucleation stage is controlled by a high number of nucleation island (NI) sites that is essentially the main reason for experimentally observed high TD density in GaN layers. In principle, lateral dislocation removal can be achieved for patterned substrates (pendeopitaxy) or during lateral epitaxial overgrowth [5]. However, these methods operate with ex situ sample manipulations and are therefore expensive. TD reactions in (0001) oriented GaN layers have much lower probability than in (001) cubic semiconductor layers. In cubic semiconductors, TDs are inclined. This helps to bring them into reaction distance during layer growth [4,6]. In (0001) nitrides, practically all TDs have their lines parallel to the growth direction and demonstrate no possibility to change mutual distances to react when the layer growth proceeds [7].

This last observation, however, gives a key to the physical basis for a new theoretical approach for TD density reduction in (0001) growth of GaN, which can be described as a two-stage growth of GaN layers. The first stage to facilitate dislocation reactions may proceed via the externally forced dislocation inclination, which can be achieved, for example, by changing to the growth mode of NIs with inclined surface facets, i.e. facets with high crystallographic plane indexes {hk.l}. High index facet plane here means a crystalline plane of wurtzite crystal structure characterized by indexes other than (0001) and those of the type {1-100} and with $l \neq 0$ in addition. For this stage I, we designate the layer with intentionally introduced surface roughness as dislocation redirection layer. Then the growth mode should be changed to the preferentially flat (0001) surface to provide enough material volume for dislocation reactions. For this stage II, we designate the growing layer as dislocation reaction layer. The two stages above can be repeated resulting in a multi-stage growth procedure.

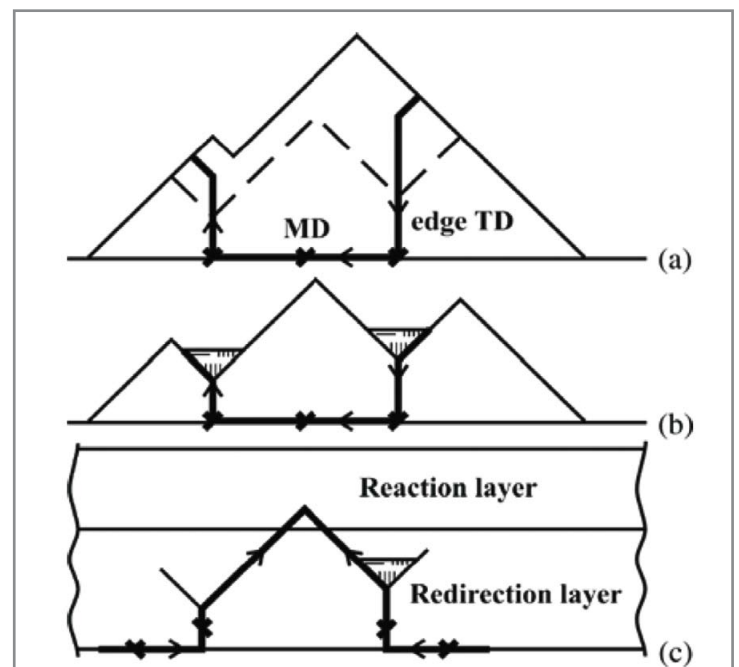

Figure 1: Schematic of cross-sectional view of the growing GaN layer: (a) stage I – inclination of TDs during growth; dashed line represents partially coalesced islands with TDs terminating at bottoms of grooves; at the interface TDs close up and form a misfit dislocation (MD); (b) stage I – optional filling of grooves with mask material to enhance the probability for TD inclination; (c) stage II – regrowth step with flattened surface and TD reactions.

The Basilica Ulpia in Rome



Zürich Airport, Switzerland



Oasis of the Seas, the world's largest cruise ship



Seoul Semiconductor changing the world!

The most famous places and monuments are already being illuminated by Seoul Semiconductors LED's

Tell us about your next bright idea

Russian Business Center



Eiffel Tower in Paris



Hotel in Turkey



Acriche

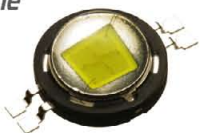

- Acriche from Seoul Semiconductor, illumination driven directly from AC (100/110/220/230V)
- Eco friendly, energy saving light source



Z-Power LED



Top View LED



Side View LED



Chip LED



Lamp LED



High Flux LED



Illumination



Display & Signs



Automotive



Mobile Appliance



Traffic Signals

Seoul Semiconductor, HQ in Korea	
• s1u0n0@acriche.com • Tel +82-31-364-3787	
Official Distributors	
• Europe GmbH	• Tel +49-69716-750111



SEOUL SEMICONDUCTOR

www.acriche.com

Figure 1 illustrates the main ideas of the approach. At the stage of growth before the layer with flat surface is formed, TDs are mostly terminated in the grooves between the neighboring NIs (see dashed lines in figure 1a). In case 3D growth mode is provided during further growth, small neighboring islands are merged into larger islands, and part of vertical TDs is terminated on inclined surfaces of the large islands. For these TDs, it is energetically favorable to change their direction of propagation, provided that the energy barrier preventing inclination of the TDs is overcome (see figure 1a). The inclination of TDs can be facilitated by deposition of a small amount of mask (e.g. amorphous Si_3N_4) material on the corrugated surface as shown in figure 1b. The TDs will stay at the interface between the new phase and GaN, due to the difference in crystallographic and elastic properties of the deposited material compared to GaN. If subsequent flat surface re-growth by GaN is performed, the TDs will stay inclined and have a high possibility to fuse or annihilate in the reaction layer (see figure 1c). As a result, a compact low dislocation density GaN film may be delivered.

The inclination of TDs in the redirection layer is governed by diminishing the TD energy (because the TD becomes shorter when it deviates to an intentionally introduced high index facet plane) compared with the energy of the TD with line direction along [0001] crystal axis. Additionally, TDs having Burgers vector of the basal plane translation type $\pm 1/3 \langle 2\bar{1}\bar{1}0 \rangle$ possess a maximum energy per unit length (described by the energy factor [8]) when their line directions are parallel to the c-axis of the wurtzite elementary cell, i.e. for the case of edge character TDs.

In the dislocation reaction layer, TDs with "frozen-in" inclined directions demonstrate a lateral motion of their intersection points with the planar layer surface (this effect was first explained in Refs. [4,6]). As a result the probability of TD interaction significantly increases, that may lead to the annihilation of two TDs with opposite Burgers vectors or to the fusion of two TDs to produce a single TD. Both these processes provide a decrease of TD density.

Reaction-Kinetics Model for Dislocation Density Reduction

The required thickness of the layers and the number of steps in the procedure depend on the targeted TD density and can be quantitatively predicted by applying a reaction-kinetics model to the description of an ensemble of interacting TDs [4]. In accordance with the above outlined ideas, the reduction of the total TD density $\rho = \rho_v + \rho_i$ (subdivided into the density ρ_v of vertical TDs and the density ρ_i of inclined TDs) should obey the system of the "reaction-kinetic" equations:

$$\frac{d\rho_v}{dh} = -f_{\text{redirect}}^v(\rho_v, \rho_i) - f_{\text{react}}^v(\rho_v, \rho_i) \quad (1)$$

$$\frac{d\rho_i}{dh} = +f_{\text{redirect}}^i(\rho_v, \rho_i) - f_{\text{react}}^i(\rho_v, \rho_i) \quad (2)$$

Here h is the layer thickness and it plays the role of an evolution variable; the functions on the right hand side, f_{redirect}^v , f_{redirect}^i and f_{react}^v , f_{react}^i , describe the processes of vertical TDs redirection, their transformation into inclined TDs and the reactions between various types of TDs. The reaction f -functions depend on a chosen method for substrate manufacturing and therefore include (in a parameterized form) the dependence on growth conditions and the masking process. They also may explicitly include the layer thickness and parameters describing the intensity of TD reactions. We consider an example, for which the reaction functions can be chosen as

$$f_{\text{redirect}}^v = f_{\text{redirect}}^i = \frac{1}{p} \cdot \frac{\rho_v}{h} \quad (3)$$

$$f_{\text{react}}^v = C f_{\text{react}}^i = \kappa \rho_i^2 \quad (4)$$

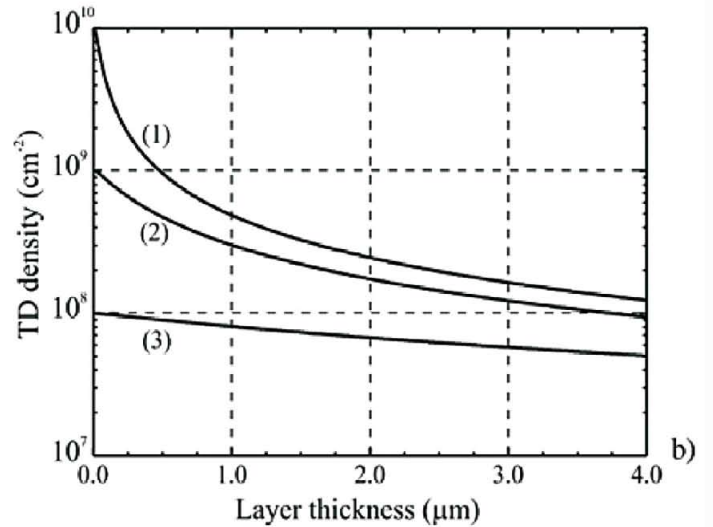
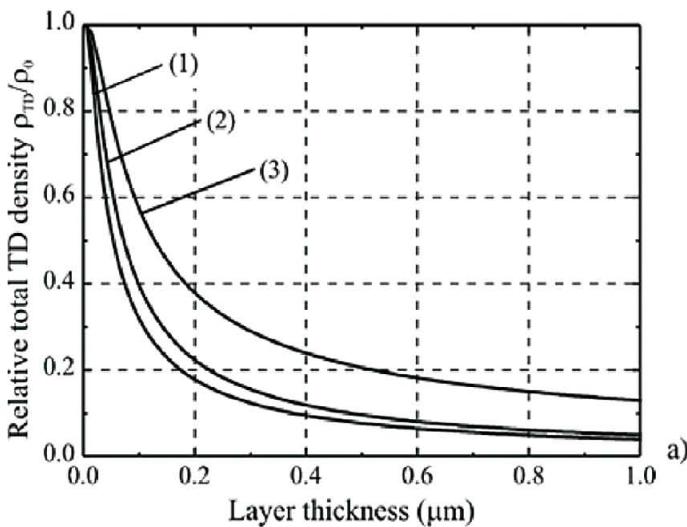

Figure 2: Model results for TD density reduction in redirection reaction layer structure: (a) relative TD density for structures with initial density $\rho_0 = 10^{10} \text{ cm}^{-2}$ and representative values for the parameter $p = 0.5$ (1), 1 (2), 2 (3); (b) absolute TD density in case $p = 1$ and various initial densities $\rho_0 = 10^{10}$ (1), 10^9 (2), 10^8 (3) cm^{-2} . For all plots the dislocation reaction parameter $\kappa = 100 \text{ nm}$. The total layer thickness includes both redirection and reaction parts.



**INTERNATIONAL
LIGHT WEEK**

1st - 3rd June 2010
Lyon - Eurexpo - France

From shadow to light !

**inLiGHT
EXPO**

THE INTERNATIONAL
INDOOR LIGHTING
TRADE FAIR

Architectural - Decorative
Specific (museum, hospitals,
conference centers...) - Shop
lighting - Security - LEDs - Fibre
Optics - Piloting and lighting
management - Light sources
Tracks - Transformers - Ballast
Connectors - Electronics
Technical studies - Installation
Maintenance Energy
production, distribution and
management

100% light !

**Lumi
VILLE**

THE INTERNATIONAL
OUTDOOR LIGHTING
TRADE FAIR

Architectural - Technical
Urban and road lighting - Specific
lighting (tunnels, airports ...)
Dynamic lighting - LEDs - Fibre
Optics - Piloting and lighting
management - Light sources
Tracks - Transformers - Ballast
Connectors - Electronics
Technical studies - Installation
Maintenance - Energy
production, distribution and
management

www.international-lightweek.com

I'm interested in Inlight Expo and/or Lumiville Trade fair - To be returned by fax to + 33 (0)4 37 40 31 69

Company: _____ Name: _____ Job title: _____

Phone N° : _____ Fax N° : _____ Email: _____



I wish to exhibit on a stand of ____ Square meters I wish to receive more informations

CONSEIL DEVELOPPEMENT ORGANISATION

Contact / information : Romain CLEVY Tel: + 33 (0)4 37 40 31 64

LEDPRO

For such a parameterization, p is related to the angle α between the facet planes in the redirection layer and the (0001) crystal plane via $p = 1/\gamma \cdot \cos\alpha (1 - \cos\alpha)$ with γ being the coefficient which depends on crystal structure and additional factors (e.g. the presence of a mask material at the grooved surface), κ is the dislocation reaction cross-section parameter. The results for TD density reduction in growing GaN layers for this particular example and with the particular set of model parameters, are given in figure 2. It is important to note that the TD density reduction rate depends on the initial TD density. Higher initial TD density leads to faster TD density reduction. This follows from the fact that at the higher density TDs have an enhanced probability of meeting each other and reacting. Therefore for further TD reduction thicker layers need to be grown, which may restrict the efficiency of this technique, in particular due to the emergence of a high level of mechanical stresses in the template. Nevertheless the clear advantage of the proposed dislocation redirection-reaction approach is that it can be performed in situ by multi-step adjusting of the growth conditions.

Experimental Realization of the Proposed Approach

Growth techniques, which provide efficient TD inclination during the initial stages of growth, become of significant importance for the fabrication of thin GaN layers with lower TD densities. To achieve prolonged high-index facet growth of NIs, a process enabling the reduction of NI density is needed. This would additionally reduce the number of coalescence boundaries between the NIs. We have previously introduced a multi-step MOCVD technique [9] for growing NIs on c-plane sapphire. Here we demonstrate how this technique can help in decreasing TD density in GaN templates.

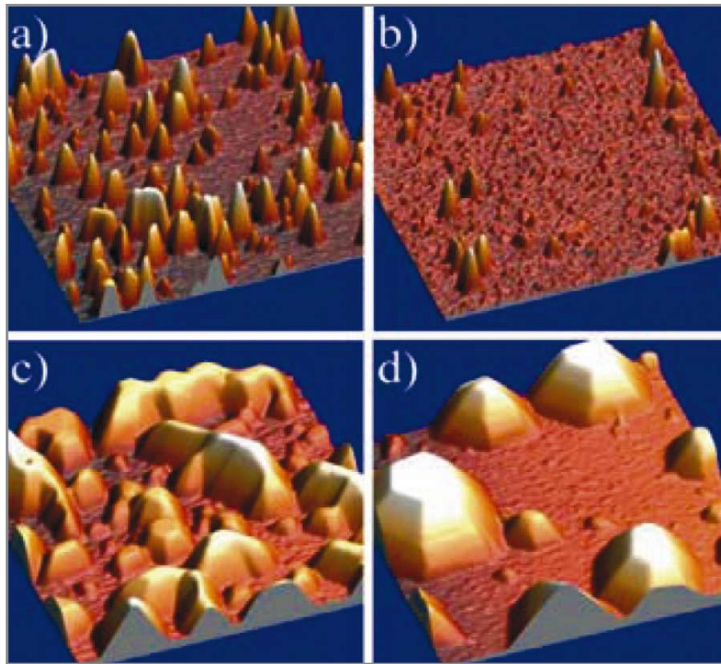

Figure 3: AFM data illustrating the NI density for a) sample A and b) sample B. The overgrowth of sparse NIs can result in formation of new islands (c). Using increased reactor pressure the formation of new islands during HT overgrowth can be suppressed (d). All the scans are $10 \mu\text{m} \times 10 \mu\text{m}$.

As a first stage of the multistep method, 3D GaN NIs were grown with a varying number of cycles and with different deposition times per cycle. One process cycle consisted of two steps; the deposition of low temperature (LT) GaN at 530°C and the subsequent annealing of this film for recrystallization as described in Ref. [9]. A TMGa molar flow rate of $60 \mu\text{mol}/\text{min}$ and an ammonia flow of 2 slm were used during the LT deposition steps. The atomic force microscope (AFM) data of figure 3 show the morphology of several samples, in which different methods for NI fabrication were used. The AFM used in our work was a NanoScope IIE system.

Sample A in figure 3a was fabricated with the standard one-cycle method by depositing LT film at 530°C and subsequently up-ramping the temperature linearly to 1060°C in 300 s for recrystallization. The growth process for sample B in figure 3b consisted of four process cycles. The total nominal thickness of deposited material was approximately 50 nm for both samples A and B. Thus, the average thickness of the LT film deposited in each cycle of the multi-step process for sample B was approximately 13 nm. The annealing steps were identical for both samples. The NI density as calculated from the AFM data for the samples A and B was $1 \times 10^8 \text{ cm}^{-2}$ and $2.5 \times 10^7 \text{ cm}^{-2}$, respectively.

As a second stage of the multistep method, the sparse 3D NIs were overgrown in a way providing a prolonged high-index facet growth for these nucleation centers. The V/III ratio was subsequently increased to 800 in order to promote island coalescence and the resulting dislocation reactions. The increase in V/III ratio additionally stimulates 2D growth and eliminates surface roughening. The NIs were overgrown at high temperature (HT) for 300–700 s in a pressure of 200–500 Torr with a hydrogen flowrate of 10–12 slm. The TMGa molar flow rate was $200 \mu\text{mol}/\text{min}$ and the ammonia flow was 3 slm during the beginning of HT overgrowth to stimulate vertical growth of the NIs. Nucleation in between the NIs was measured by AFM. The GaN island density of about $4 \times 10^7 \text{ cm}^{-2}$ in figure 3c is higher than the original NI density in figure 3b. For the sample in figure 3c, the reactor pressure and hydrogen flow rate were 200 Torr and 10 slm, respectively. Increasing the total pressure to 500 Torr reduced the nucleation in between the original NIs. This can be observed from the AFM data of figure 3d, where the island density is about $1.7 \times 10^7 \text{ cm}^{-2}$. The result is caused by enhanced GaN decomposition at a higher pressure [10]. The faster decomposition of the thermally more unstable film in between the NIs suppresses new island formation. This causes nucleation to occur selectively on the original NIs.

Low Dislocation Density GaN Templates

Due to prolonged vertical growth of NIs enabled by a low NI density, more efficient TD inclination is likely to occur. Cross-section transmission electron microscopy (TEM) was used to determine the orientation of TDs inside a NI overgrown at HT with a low V/III ratio. The measured sample was grown in a process which was interrupted prior to the coalescence of NIs. In the TEM data of figure 4 one can clearly observe that an essential part of the TDs incline from the [0001] direction and become perpendicular to a high-index facet of the NI. This type of

The gateway to success in Asian market

Most promising exhibition in the lighting industry.
500* exhibitors and 25,000* visitors gather.
(* expected)

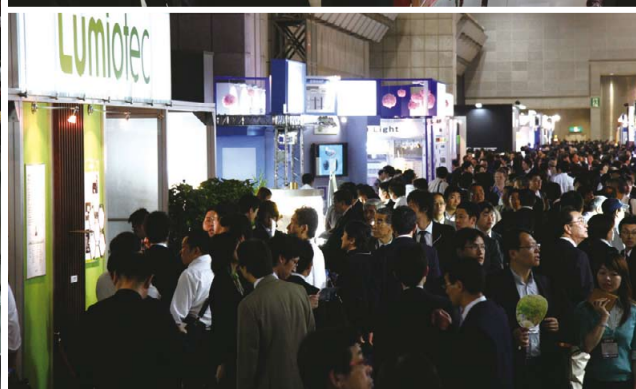
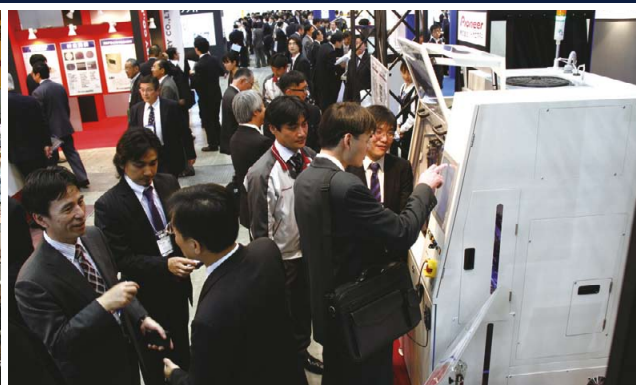
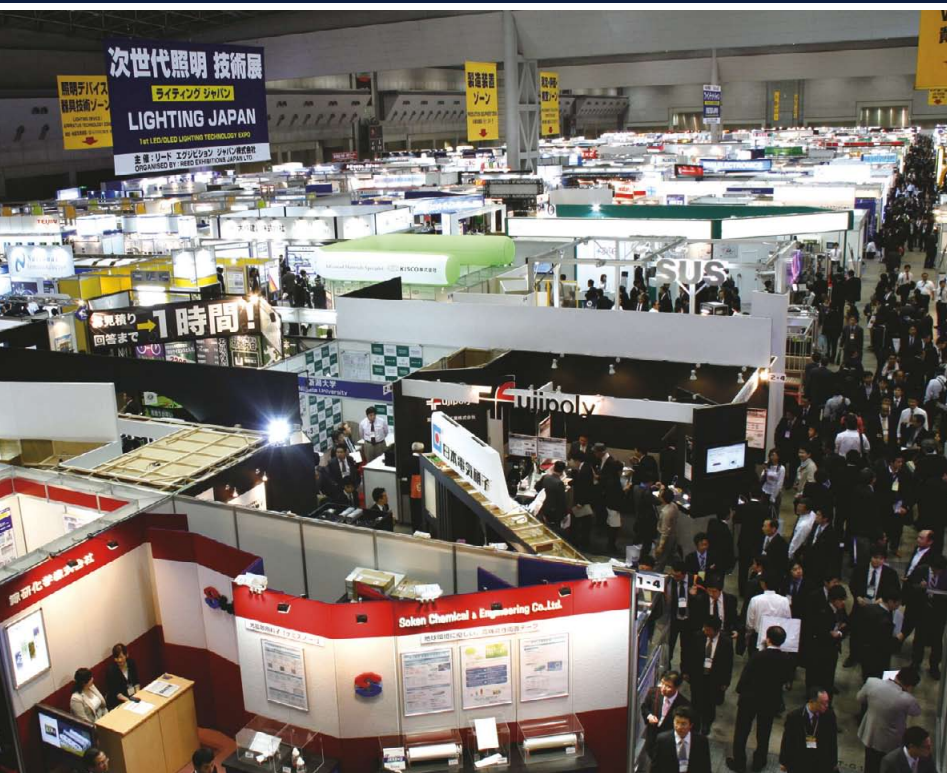

Lighting Devices

Equipment

Components

Materials

2nd **LED/OLED** Lighting Technology Expo

LIGHTING JAPAN

Dates : April 14 [Wed] - 16 [Fri], 2010

Venue : Tokyo Big Sight, Japan

Organised by : Reed Exhibitions Japan Ltd.

More Information >>> www.lightingjapan.jp/en/

Organised by
 Reed Exhibitions

LIGHTING JAPAN Show Management, Reed Exhibitions Japan Ltd.

18F Shinjuku-Nomura Bldg., 1-26-2 Nishishinjuku, Shinjuku-ku, Tokyo 163-0570, JAPAN
TEL: +81-3-3349-8568 FAX: +81-3-3349-0598 E-mail: light@reedexpo.co.jp

inclination of TDs inside NIs has not been previously demonstrated by in-situ techniques. The TEM system used in this work was a Philips EM420 electron microscope operating at 100 kV. To resolve for different types of TDs, the diffraction conditions for two mutually perpendicular crystalline planes [0002] and [0110] were fulfilled in cross section and plane view measurements.

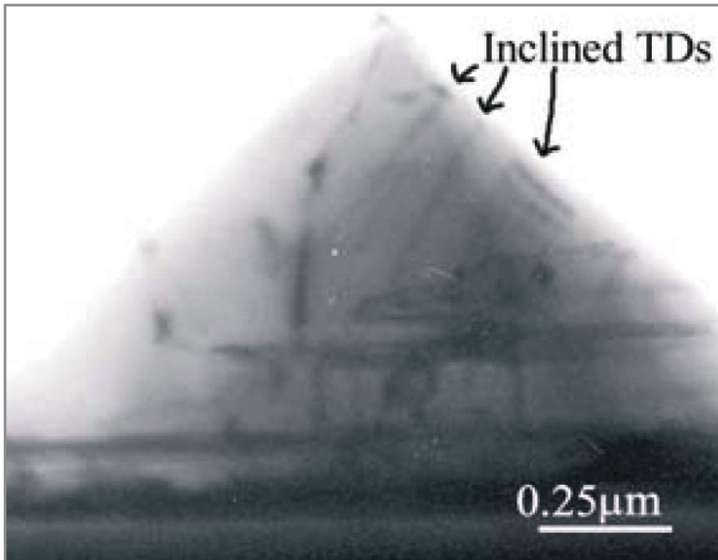

Figure 4: Cross-section TEM data from a NI overgrown at HT with a low V/III ratio. TDs incline to become perpendicular to high-index facets of the NI.

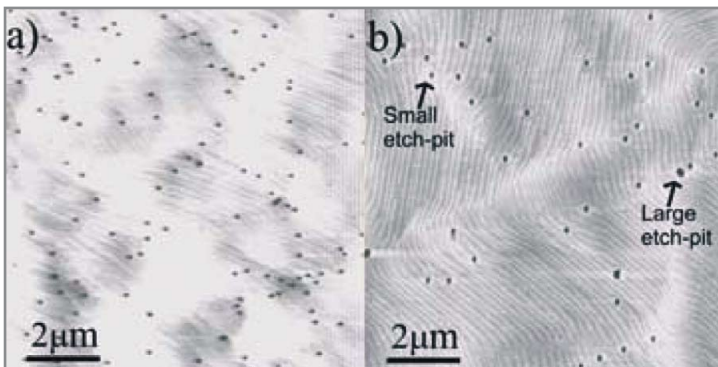

Figure 5: AFM data illustrating the EPD of GaN films grown by a) the standard two-step process and b) the multistep process. Both scans are $10 \mu\text{m} \times 10 \mu\text{m}$. The vertical scales are 2 nm for both images.

Several samples were etched in a 1:1 mixture of ortho-phosphoric acid and sulfuric acid after the growth process. The density of etch-pits was subsequently measured by AFM. Figure 5 illustrates the AFM data for two $2.3 \mu\text{m}$ thick GaN films with etch-pits on their surface. Figure 5a shows the etch-pit density (EPD) for a sample grown by the standard two-step method. A NI density of $1.6 \times 10^8 \text{ cm}^{-2}$ was used for the nucleation layer. Figure 5b is an EPD scan from a sample grown by the multi-step process. For this sample a NI density of about $5 \times 10^7 \text{ cm}^{-2}$ was obtained and no surface roughening of the buffer layer was observed. The found EPD was $1.4 \times 10^8 \text{ cm}^{-2}$ and $5.0 \times 10^7 \text{ cm}^{-2}$ for the standard sample and for the multi-step sample, respectively. The results of the EPD measurements were also supported by plan-view TEM observations. The experimentally obtained TD density of $5.0 \times 10^7 \text{ cm}^{-2}$ is in good agreement with the modeling results.

Advanced Technologies for LED Industry

Theoretical and experimental results on the reduction of TD density in III-nitrides and the manufacturing of low dislocation GaN templates give one particular example of the development of advanced technologies for LED industry. Another important aspect in the production of high quality GaN templates and buffer layers is the reduction of the level of internal mechanical stresses in the template interior. A new method for the reduction of mechanical stresses was recently proposed. The method is based on the creation of micro- and nanopores in the semiconductor structures with the help of controlled etching and the following change in the growth regimes of III-nitride layers (see figure 6).

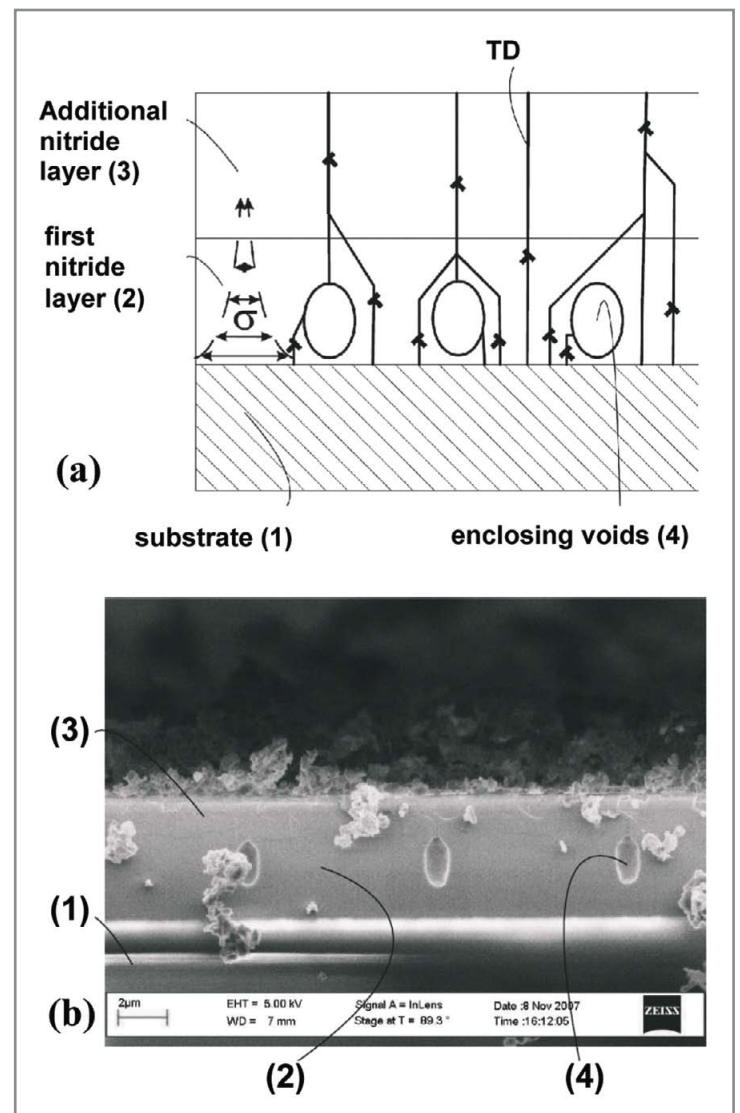

Figure 6: Schematics (a) and cross-section (b) of mechanically stable low-dislocation density porous GaN buffer layer placed on a thin sapphire substrate.

The presence of pores in GaN buffer layer allows to enhance the light extraction from LED chips due to effective change of the substrate refraction index. The other technique worked out for efficient light extraction utilizes the insertion of light diffusing interlayer in the chip. Important components of these technologies are directed to the control of physical processes in the working region of the light-emitting heterostructures and to the optimization of the electric current flow in the chip. Both these technologies are covered by national and international patents, e.g. European patent under number EP1903619B1 [11].

Conclusions

We have demonstrated a multistage growth method to substantially decrease the TD density in MOCVD grown GaN epilayers. By reducing the amount of LT material deposited in each cycle of the multi-step process a significant decrease in the NI density was obtained. A low V/III ratio was used to stimulate vertical growth of the NIs before coalescence, which resulted in the formation of large high-index facets for the NIs. This shape of the NIs provides efficient TD inclination during the initial stage of HT growth and subsequently increases the probability of reactions between TDs at the second stage of growth with essentially flattened surface. The proposed method enabled a reduction in the TD density down to $5.0 \times 10^7 \text{ cm}^{-2}$ and in situ manufacturing high-quality GaN and other III-nitrides templates. ■

Annotations:

The details on the development and applications of the multistage growth techniques to the fabrication of low dislocation density III-nitride templates can be found in our publications [12-14].

References:

- [1] S. Nakamura, "GaN growth using GaN buffer layer", *Japanese Journal of Applied Physics*, vol. 30, pp. L1705-L1707, Oct. 1991.
- [2] J. S. Speck, S. J. Rosner, "The role of threading dislocations in the physical properties of GaN and its alloys", *Physica B*, vol. 274, pp. 24-32, Dec. 1999.
- [3] J. Jasinski, "Classic and novel methods of dislocation reduction in heteroepitaxial nitride layers", *Physica Status Solidi (c)*, vol. 2, pp. 994-1005, Feb. 2005.
- [4] A. E. Romanov, W. Pompe, G. E. Beltz, J. S. Speck, "An approach to threading dislocation, 'reaction kinetics'", *Applied Physics Letters*, vol. 69, pp. 3342-3344, Nov. 1996.
- [5] P. Gibart, "Metal organic vapour phase epitaxy of GaN and lateral overgrowth", *Reports on Progress in Physics* vol.67, pp. 667-715, May 2004.
- [6] J. S. Speck, M. A. Brewer, G. E. Beltz, A. E. Romanov, W. Pompe, "Scaling laws for the reduction of threading dislocation densities in homogeneous buffer layers", *Journal Applied Physics*, vol. 80, pp. 3808-3816, Oct. 1996.
- [7] S. K. Mathis, A. E. Romanov, L. F. Chen, G. E. Beltz, W. Pompe, J. S. Speck, "Modeling of threading dislocation reduction in growing GaN layers", *Physica Status Solidi (a)*, vol. 179, pp. 125- 145, May 2000.
- [8] S. Gradecak, P. Stadelmann, V. Wagner, M. Illegems, "Bending of dislocations in GaN during epitaxial lateral overgrowth", *Applied Physics Letters* vol. 85, pp. 4648-4650, Nov. 2004.
- [9] T. Lang, M. Odnoblyudov, V. Bougrov, M. Sopanen, "MOCVD growth of GaN islands by multistep nucleation layer technique", *Journal of Crystal Growth*, vol. 277, pp.64-71, Apr. 2005.
- [10] D.D. Koleske, A.E. Wickenden, R.L. Henry, J.C. Culbertson, and M.E. Twigg, "GaN decomposition in H-2 and N-2 at MOVPE temperatures and pressures", *Journal of Crystal Growth*, vol. 223, pp. 466-483, Mar. 2001.
- [11] "Semiconductor Heterostructure, V. Bougrov, M. Odnoblyudov, Optogan Oy, Patent EP 1903619B1, European Patent Specification, Bulletin 2009/46.
- [12] V.E. Bougrov, M.A. Odnoblyudov, A.E. Romanov, T. Lang, O.V. Konstantinov, "Threading dislocation density reduction in two-stage growth of GaN layers", *Physica Status Solidi (a)*, vol. 203, pp. R25-R27, Mar. 2006.
- [13] T. Lang, M.A. Odnoblyudov, V.E. Bougrov, A.E. Romanov, S. Suikonen, M. Sopanen, H. Lipsanen, "Multistep method of threading dislocation density reduction in MOCVD grown GaN epilayers", *Physica Status Solidi (a)*, vol. 203, pp. R76-R78 Aug. 2006.
- [14] T. Lang, M.A. Odnoblyudov, V.E. Bougrov, S. Suikonen, O. Svens, P.T. Torma, M. Sopanen, H. Lipsanen, "Reduction of threading dislocation density in Al0.12Ga0.88N epilayers by a multistep technique", *Journal of Crystal Growth*, vol. 298, pp. 276-280, Jan. 2007.

Photonics Festival in Taiwan

LED 2010
LIGHTING Taiwan

LED Lighting Taiwan
The 6th Int'l LED Lighting Exposition
<http://www.optotaiwan.com>

June 9-11, 2010
Taipei World Trade Center

Exhibits

- **LED Lighting Fixture**
for Indoor, Outdoor, Specialty, Solar for Decorating, Landscape, Architecture, Garden Control System & Accessories
- **LED Applications**
Automotive Lamps, Backlight, Display Board, Traffic Signal, IrDA, etc.
- **Package / Module**
Lamp, Digital, Dot Matrix, Cluster, SMD, etc.

- **Epi Wafer, Chip**
- **Materials**
Substrate, Ingot, Phosphor, Epoxy, Lead Frame, etc.
- **Processing Equipment**
Wafer (MOCVD, Mask, Etching)
Assembly (Dicing, Bonding, Packaging)
Testing (Prober, Aging)

Organizer



Photonics Industry & Technology Development Association

5F, No.9, Roosevelt Road, Sec.2, Taipei 10093, Taiwan

<http://www.pida.org.tw>

Tel : +886-2-2351-4026 Fax : +886-2-2396-8513

Pamela Hsiao (ext. 805) E-mail : exhibit@mail.pida.org.tw

Allen Lee (ext. 850) E-mail : allen@mail.pida.org.tw

Thermal Management

LED – Cooling and Thermal Management

> Lothar Noelle, Fischer Elektronik

As we all know, the life span of an LED depends on the semi-conductor material used as well as the current/heat relationship. The light output of the LED becomes weaker and weaker and once it reaches 50% of its initial value, the life expectancy of the LED has, by definition, been reached.

A life span of a few hundred and up to 100,000 hours is possible, but only when avoiding high temperatures which drastically reduce the length of the LED's life.

The radiant power or the luminous flux of an LED is very much dependant on the temperature of the semi-conductor. This means that the efficiency of the LED clearly diminishes the higher the temperature is.

Even when an LED is referred to as a "cold radiator", the entire electric energy in the LED is not converted into luminous power. Here, just like other semi-conductors, a large portion of the electric energy (70%-80%) is converted into heat. This is why; unlike thermal radiators (light bulb) thermal management (cooling) is absolutely necessary. The effectiveness or in other words, the efficiency of the LED is the relationship of radiated luminous flux to applied electrical energy and is specified in Lumens per Watt (lm/W).

All the wonderful characteristics of the white radiating high efficiency LEDs, and with them, the new possibilities for modern lighting technology, can only work trouble free and lastingly when thermal technical boundary conditions are adhered to.

Various designs of light emitting diodes, always adapted to their intended purpose, are available on the market. Wired LEDs as an indicating element, SMT designs in PLCC housings, hexagonal and octagonal designs with diverse production descriptions and especially the COB (Chip on Board) versions, where the LEDs are soldered directly onto the printed circuit board.

The highest possible luminous flux is needed from the high performance LEDs for lighting purposes; semiconductor technical concepts, new designs, multiple chips in one casing, and so on, make optimal thermal management necessary.

Thermal Relationships

The surrounding temperature and with that, the temperature of the chip, directly influences the efficiency and life span of the LED. Semi-conductor LEDs change their emission characteristics with time and the intensity of the light yield gets continually weaker. This behaviour is known as ageing or degradation and is related to the increase and enlargement of the impurities in the chip (semi-conductor crystal).

A too high luminous flux from increased electrical power also increases the temperature in the LED and big temperature differences also shorten the life span considerably.

The synthetic materials used for the enclosures and lenses (epoxy resin, silicon, etc.) of the LED are also prone to ageing which can cause cloudiness.

Temperature Related Malfunctions

The ambient temperature and self-warming through electrical current effect the temperature of the chip. The effect on the light yield, light color and forward bias also correlates directly to the LED's chip temperature.

The luminous flux (Φ) as a function of the temperature is to be calculated as follows:

$$\Phi v(T_2) = \Phi v(T_1) e^{-k\Delta T_j} \quad (1)$$

$$\Phi v(T_1) = \Phi v(T_2) e^{-k\Delta T_j}$$

T_1 = Luminous flux for T_j 1

T_2 = Luminous flux for T_j 2

k = Temperature coefficient

ΔT_j = Change in temperature T_j ($T_2 - T_1$)

An example of degradation as a result of temperature increase is shown in figure 1:

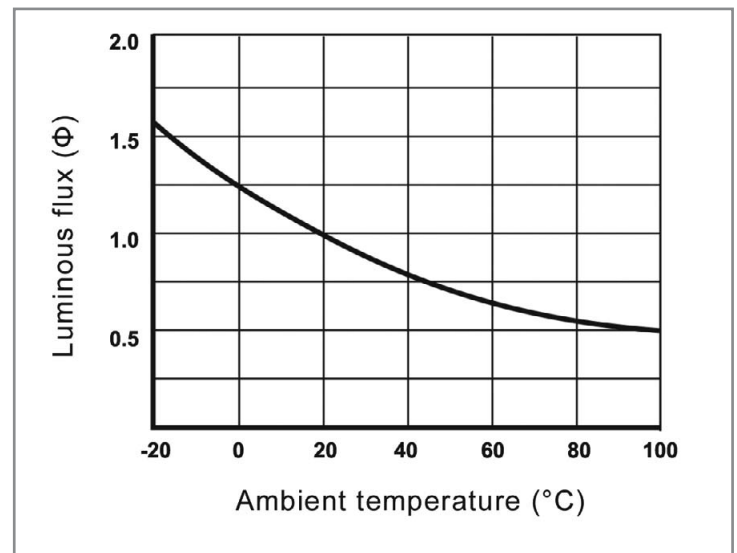
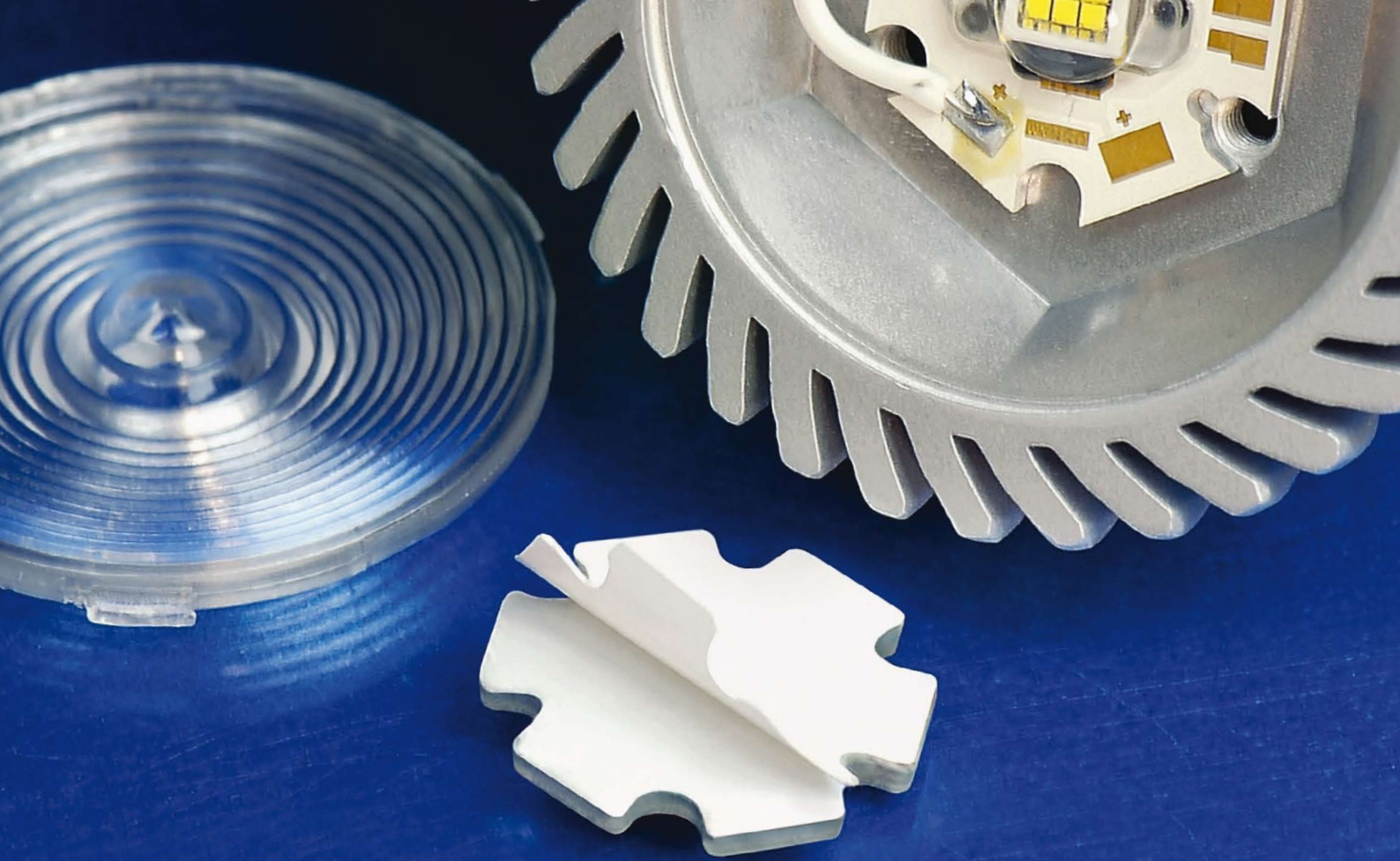

Figure 1: Luminous flux vs ambient temperature for red LED by constant current (according to documents from the company Lumileds).

The curve shows that a temperature increase from 25°C to 75°C reduces the luminous flux by almost half.

Depending on the temperature, the glass transition temperature of the die enclosures, that is, the transition from a hard-fast to a softer condition has a big influence on the LED. A change in the thermal



NEW T-CLAD[®] PA SIMPLIFIES ASSEMBLY.

Peel & place thermal solution withstands the heat of solder reflow.

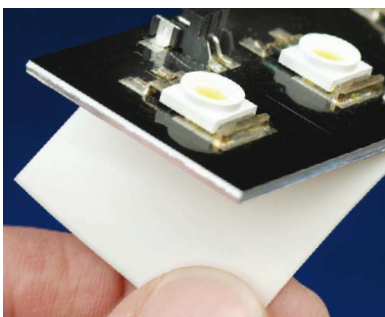

Thermally conductive insulated metal substrate boards specifically configured for LED applications.

Easier assembly, cooler LEDs.

Bergquist's T-Clad with pre-applied Bond-Ply[®]450 allows you to adhere your mounted LEDs to a variety of heatsinks and surfaces while thermally optimizing your application. This version of peel and place T-Clad can withstand the high temperatures of solder reflow during LED assembly and then be positioned in the lighting application using its strong thermally conductive adhesive.

Call **+31 35 538 0684** or visit **www.bergquistcompany/TCladPA**



Bramenburg 9a, 3755 BT Eemnes • The Netherlands • www.bergquistcompany.com
Tel +31 35 538 0684 • Fax +31 35 538 0295 • Email: info@bergquist-europe.com

Thermal Materials • Thermal Substrates • Fans and Blowers

expansion co-efficiency of the material is basically a consequence of an increase in the enclosure temperature. In order to avoid failures here, it must always be made sure that the junction temperature T_j is not higher than the enclosure temperature.

The known correlations in heat engineering and the observations of Thermal Management lead to a deeper understanding of temperature power loss when calculating the thermal resistance with the formula:

$$R_{thja} = \frac{T_j - T_a}{P} = \frac{(\Delta T_j - T_a) - T_a}{P} = \frac{\Delta T_{ja}}{P} \quad (2)$$

Whereby: $T_j = \Delta T_j + T_a$

R_{thja} = Temperature loss junction / ambient

T_j = Junction temperature

T_a = Ambient temperature

P = Overall power of the LED ($I_f * V_f$)

In practice, the relevant value of the junction temperature is calculated like this:

$$T_j = R_{thja} * P + T_a$$

Thermal Management

The optimal heat engineering interpretation for definite cooling is extremely complex because the construction of an LED and the consideration of all of the relevant thermal resistance as the sum of the individual thermal resistance of the materials and junctions have to be taken into account. Only about 20% to 35% of an LED power rating is converted directly into light – the rest of the power is heat loss and has to be dissipated away from the components in the system when running the LED, and emitted into the environment. This can be easily done using an artificial surface magnification of the LED assembly contact zone.

There are three possibilities available for cooling the LED; in the light casing, the printed circuit board (conductor paths, metal-clad PCB) and using heat sinks which are either glued or soldered onto the PCB or mounted separately.

The cooling path over the light casing is made up of two partial paths. One is the junction to the contact pins and one to the light casing, that is, contact pins to the ambient air. These result in a minimal heat sink and are therefore not reliable especially for high performance LEDs.

Another type of cooling is when a heat sink is attached to the PCB on which the LEDs are mounted (if intended). There are diverse scopes for design for the user.

For very little heat, a simple FR4 PCB material with additional pressed on heat conductor paste for better heat transfer may be enough in a very few cases. For more heat a special PCB construction design is used since FR4 is not a very good heat conductor.

The metal-core PCB is used a lot for LED cooling. A basis plate made from aluminium can transfer the heat that comes from the LEDs over the Thermal Vias or Thermal Coins (copper continuous bonding) either directly or over an additional mounted heat sink into the ambient.

Besides the rigid PCB it works the same for flexible PCBs made of PET, PEN, PI, etc. because there is also the possibility to, for example, glue on an aluminium heat spreading area and a heat sink.

For high performance LED implementations, cooling using a heat sink is imperative. For this there are different basic approaches for the design of the heat sink.

Using heat sinks for free convection is a confirmed concept for cooling high performance (power) LEDs today. For this purpose the LEDs that must be cooled are affixed to the chosen heat sink.



Figure 2: Some standard heatsinks out of a broad range.

Choosing the Appropriate Heat Sink

Once the thermal criteria have been set up (the documents and guidelines from the LED manufacturer should always be taken into account), the thermal resistance has been calculated and the mounting situation has been considered along with the space/room that is available, then the appropriate heat sink can be chosen.

Special thought should be given to the orientation of the heat sink in the room. Comb shaped profiles should be installed so that the natural convective buoyancy is not hindered. It should be made sure that the most barrier free air supply and air discharge as possible is used with active cooling. The suppliers of heat sinks for LEDs show the thermal resistance in relation to the heat sink in their diagrams.

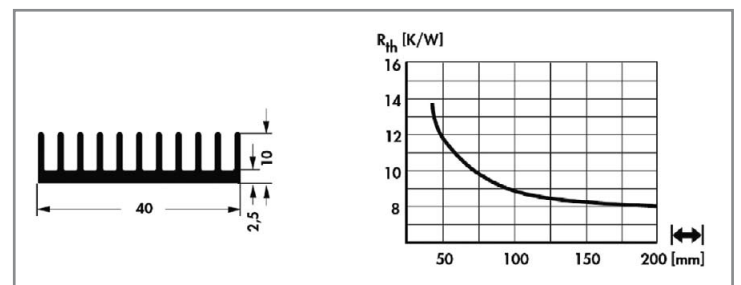

Figure 3: The diagram shows the thermal resistance of a heatsink as subject of the size.



www.ledlightforyou.com

How may we help you?

Certified Partners from all over the world are available in the LED Light for you network. They will be happy to support you with system integration and optical, thermal and electronic solutions. Look and see!

Meet us at the
light+building
Hall 4.1 – Booth D50

The network for LED lighting technology.

LED  **Light for you**
powered by OSRAM

Using the data from the calculated thermal resistance, the user can read the value that can be obtained in the diagram supplied by the heat sink manufacturer and then choose the appropriate heat sink for the specific application.

Specially coordinated concepts have been developed for the steadily increasing demand for LED heat sinks. Besides the many standard heat sinks that can be used for cooling LEDs, special modified versions of heat sinks for LEDs and individual LED systems are now available.

For an additional heat spreading area, there is the possibility of a copper coating on the bottom of the heat sink, whereby the copper surface can often be soldered which, in turn, makes direct solder mounting of the LED onto the heat sink possible.



Figure 4: Often as an application specific heatsink, it is best to use an adapted standard heatsink.

The effectiveness of cooling can be increased with the use of moving air. A heat sink with a ventilator can, depending on the application, improve heat removal by about 40%. The heat sinks used for this are specially designed for good heat removal using moving air.

Active cooling is not noiseless, though. Airing motors and movement of the air create sound waves that are not wanted in many applications like household lighting, concert halls, institution rooms, etc. On the other hand, there are airing concepts today that have slow turning rotors and special fan blade geometries which have a very low noise level. A soft suspension bracket of the ventilator on the heat sink, with no screw connections, but rather a rubber bearing with an integrated mounting decouples the sound waves and reduces imbalances of noise development of the ventilator bearing. The high quality ventilation motors have already been burn-in tested and have a considerably lower failure rate and a life span expectancy of 200,000 hours MTBF – which

is higher than the expected life span of the LED. Some ventilation motors can be controlled by PWM and are therefore well suited for utilization.

Other positive aspects of the air cooling are, besides the low temperatures, the lesser amount of pollution (dust deposits), and especially a more uniform heat distribution when being frequently turned on and off.

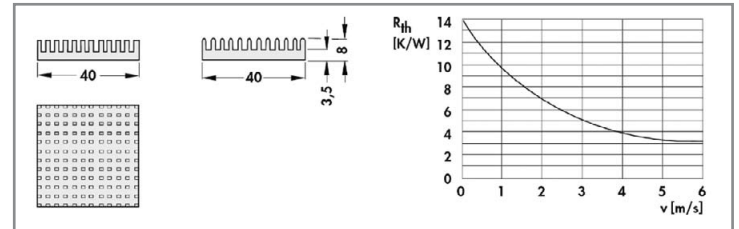

Figure 5: For the choice of a suitable cooling element with circulating air, the corresponding thermal resistance diagrams depending upon the speed of the air are given. These are helpful in the determination of the appropriate heat sink.

Other cooling possibilities for a large amount of heat by LED applications are, for example thermoelectric cooling (Peltier element) or liquid cooling (micro-channel, etc.) however, their use is only marginal because they are very complicated and expensive.

Installing LEDs

Special attention and care must be given to the connection between the LED and the heat sink. If the heat transfer between the LED and the heat sink is poor, the heat conduction reduces the heat transfer and the temperature of the LED is markedly increased. The performance and the luminous power can then be restricted and a rise in temperature high enough to destroy it is possible.

The best possible connection between the LED component and the heat sink can only be achieved when the inevitable irregularities and roughness that occur during production on the surfaces that are to be connected are smoothed out and the air bubbles that hinder heat transfer are avoided.

Especially with a mechanical fastening of the LED using screws, the use of a thermal paste that leads to improved heat transfer is necessary and advisable. An adhesive fastening using a double sided tape or also two component epoxy resin heat conductor adhesive smooth out the irregularities similarly. When using adhesives, though, it must be taken care that no or only very little volatile organic compounds are transpired since they could lead to clouding the plastic covering/lens by condensing on the surface of the LED.

A very good thermal connection to the heat sink etc. can be achieved when for a number of suitable LED models, a solder mounting connection by means of reflow or IR soldering is used.

Basically, by all types of fastenings, it should be taken care that none of the neighbouring or added heat emitting electronic components, resistors, transistors, etc. of the LED hinder heat transfer or even couple additional heat into the system.

LEDs for Lighting

The lighting LEDs can be implemented in many areas due to their low mechanical dimensions and stability, high efficiency and long life.

A light beam without IR and UV rays predestines LEDs for use in the medical sector and everywhere where light-sensitive objects have to be illuminated (museums, galleries).



Figure 6: Different applications require different thermal management solutions.

With respect to jolting, shock and vibrations, the relative ruggedness of the LED is a significant factor in its implementation in automotive engineering, from the automobile to the bicycle to rail, ship and aviation engineering.

The long life span of the LED is a big advantage when implemented in seldom used equipment (indicator lights) or difficult to access areas (explosion risk) and high maintenance equipment (street lights and other signal lights). Environmental and price advantages are added to that since LEDs don't contain any environmentally unsafe substances and operate very energy efficiently. Last, but not least, new and diverse design liberties for lighting purposes offer interesting solutions that were not obtainable with the illuminants available up until now.

Closing Remarks

The LED will establish itself on the market as the universal light source for all types of lighting applications. When taking the different installation conditions into consideration, many applications will need a heat sink. The appropriate thermal management will be there to support fast development and guarantee a lasting and faultless operation of the LED. ■

eurolED

2010



Europe's Leading Conference, Exhibition & Gala Dinner in
Solid State Lighting

9th & 10th June 2010, Ricoh Arena, Coventry, UK

Premier sponsors:

anglia lighting

EVERLIGHT
LIGHTING FOREVER

MARL

OSRAM
Opto Semiconductors

eurolight sponsor:

eurolight

For further information visit www.euroLED.org.uk or call +44(0)121 250 3515

Drivers

Intelligent LED Driver/ Controllers Becoming Standard Modules

> Albert Berghuis, General Manager, eldoLED

LEDs have over the years become the dominant lighting technology in colored, dynamic architectural and entertainment lighting. This has become reality amongst others by parallel innovations along the LED, optics, thermal management and driver electronics axes. As of late adding a fourth color (white or amber) in a single package LED array has greatly enhanced the available color gamut, but successful implementation in products occurs only if optics and driver electronics are up to delivering the quality of mixed light required in these applications.

For general lighting, LEDs have become successful largely by gains in system efficiency, allowing the LED to push out traditional technologies based on overall cost of ownership. These successes have primarily taken place in the professional lighting space where cost of maintenance is an item to be taken into account. For the consumer market at this moment there is a high-end market for LED luminaries and a huge offer of LED-based replacement bulbs. The general expectation is that replacement bulbs will be the driving force in consumer LED lighting for the coming years and LED luminaries will gradually replace traditional fixtures. In both cases we still need a number of parallel innovations to achieve the cost/performance levels that drives these markets.

LED technology is pushing up the product / technology maturity curve at different speeds for different applications. This means that while some products are achieving their first numbers in mass production other applications remain in the very first stage of the product life cycle

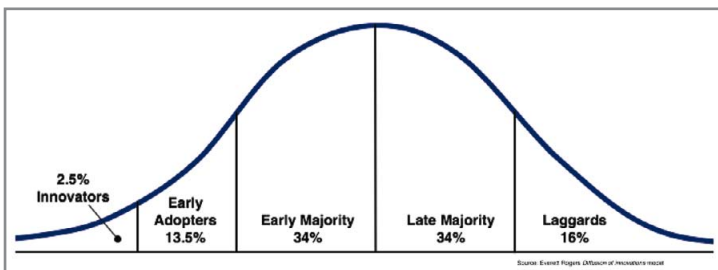

Figure 1: Typical of these early stages of the product or technology life cycle are rapid expansion of available technology choices before the market settles on a smaller number of solutions later on.

This is particularly true for LED drivers: options have increased dramatically. The definition LED driver seems to cover everything: from a chip or rectifying bridge to a 24 V power supply or a fully integrated mains voltage, multiple control channel, constant current LED driver / controller.

Your application and resulting choice of LEDs will determine whether a constant voltage or constant current LED driver is needed. Your business strategy defines whether a chip (and subsequent driver development) or sourcing a complete driver / controller product is required.

Many of the chip-based solutions require significant electronics expertise and investment before a final drive solution is ready. While this may be fine for large entertainment and lighting companies for (more mature) products running in significant volumes, the nature of architectural dynamic colored and general lighting projects is often specific, low volume and with a short delivery time. Many of the professional and consumer white lighting applications have not yet progressed far enough on the product/technology maturity curve to achieve volumes that warrant significant investment in specific driver development.

To the other extreme are LED driver / controllers as a ready product. These are offered in a wide range from very focussed single feature products to more intelligent drivers which can be used in a flexible manner in a range of applications.

Over the last 5 years eldoLED has developed integrated LED Drive, Networking and Control technologies. These technologies and products are available in a number of tuned business models to various stages of the product/technology life cycle.

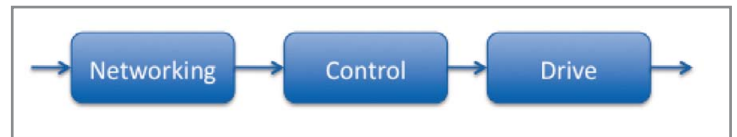

Figure 2: Intelligent drivers consist of three different parts and, hence, three intelligence levels.

Most visible are standard driver / controller products like ECOdrive and POWERdrive for constant current applications and LINEARdrive for constant voltage solutions. SOLOdrive AC and DUALdrive AC cater to direct mains connected, constant current, general white lighting applications.

Specific versions of these standard products are available through a customisation program, where customer-specific products benefit from existing product realisation, quality and certifications. Customizations are available in medium/low volumes at short lead-times.

Design-in is as close to an IC cum reference design as we go. The Design-in program starts a drive/controller design from a clean sheet – and delivers a certified product and tooling ready for production in volume. These projects typically require intimate co-operation between design teams allowing each team to focus on respective strengths.

A large portion of the customizations and Design-in work was done, particularly over the last period, focuses on adding intelligence into lighting fixtures thereby enhancing the overall value proposition.

guangzhou international lighting exhibition

广州国际照明展览会

The biggest lighting industry forum in Asia

9 – 12 June 2010

China Import and Export Fair Pazhou Complex
Guangzhou, China

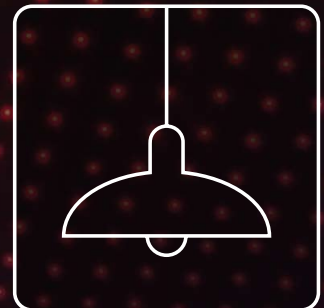
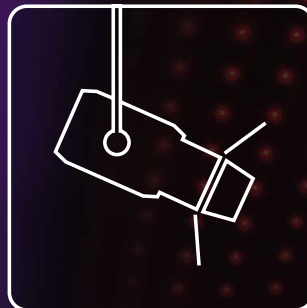
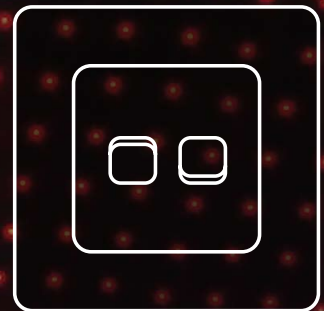
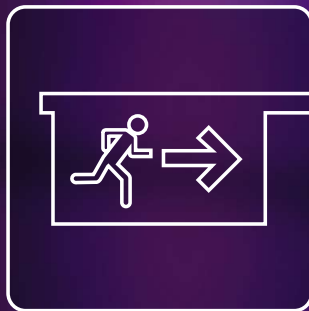
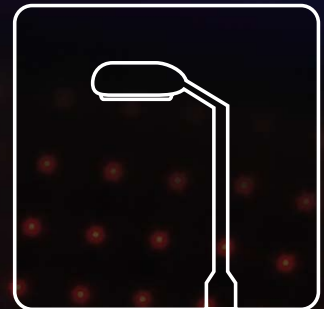

For more information, please contact:

Tel: (852) 2238 9937

Fax: (852) 2598 8771

LBguangzhou@hongkong.messefrankfurt.com

www.light.messefrankfurt.com.cn

Network Intelligence

For dynamic colored applications DMX has been a standard for quite some time. The basic principle of DMX is a continuous, high frequency update of control set points by the DMX controller to all connected DMX devices. DMX networks have typically been used in the theatre and show world. With LED lighting we have seen them progress into large colored architectural applications, some of them becoming landmarks like the Bird's nest in Beijing for the Olympic Games. Requirements for these large outdoor networks are quite different from those in the indoor show lighting world. Electronics used in outdoor applications need environmental protection and may not be accessible after, or even during installation. Where before setting up a DMX network was a dipswitch adventure this obviously doesn't work in today's outdoor networks, simply because the fixtures and electronics cannot be reached. Similarly the outdoor environment is completely different from the inside of a theatre. Temperatures may differ significantly between the north and south sides of a structure and depending on the time of day ambient light levels may require different lighting levels – control set points.



Figure 3: In DMX networks, RDM and LedSync provide a solution for many of these more intelligent network requirements: explore and address for setting up the network and temperature and other sensor feedback to the DMX controller can be implemented ensuring normal operational conditions prevail (Image: ©Fortunati 2009).

For general (white) lighting network requirements differ. As an example we do not need general lighting to change dynamically in terms of color or intensity – actually more gradual changes are preferred. DALI as networking protocol focussed on general lighting has been around for years. The interest in control for large general lighting networks has been increasing significantly over the last period. Adding both stand-alone and networked intelligence has largely focussed on increased energy efficiency – making sure lights are switched off when not needed or dimmed when less light output is needed. The required light level can be based on time or local and networked (daylight) sensor inputs.

Controlling light levels with intelligent occupancy sensing, and light sensors – either stand-alone or over a DALI network can make a dramatic improvement to the value proposition of LED-based fixture systems – the nature of LEDs mean they can be accurately dimmed and switched without affecting the life of the LEDs – in fact, dimming further extends the life of the LED. LEDs last a long time and suffer degradation approximately ~ 20% over 50,000 hours in a well-designed luminary system. Again using a stand-alone algorithm or combined in a network, the degradation can be tuned out of the system, by making small adjustments in the output as time dictates.

DALI readily accepts multi master inputs – a switch by the door, a daylight or motion sensor and/or control inputs from a building management system may be combined. DALI itself is evolving to include more complex lighting systems where white lighting color temperature control is needed or even full color applications.



Figure 4: Whether in DMX, DALI or DALI Color it is clear that LED lighting electronics are evolving rapidly to enhance lighting networks by providing local feedback to the controller, by gracefully adjusting fixture power settings to stay within operating (temperature) limits or by adjusting the mix of separate colors based on local temperature or color feedback.

Control Intelligence

The control block is all about translating a network set point into a light output or power level. In constant current applications the basic approaches to power modulation are well known: either change the current setting or change the 'on' time – also referred to as pulse modulation.

Most efficient LED solutions use some form of pulse modulation to achieve different power set points, typically there is a pulse generator and a driver IC where the latter controls a current source driving LEDs. Basic implementations may suffer from a too low pulse frequency resulting in visible and non-visible flicker in steady state. Dynamic lighting applications require more accurate and an even higher frequency current source control for smooth dimming (is high resolution) and high contrast (very low light output at the lowest set point).

In applications that are extremely vulnerable to switching frequencies, direct current control – setting a current source to a certain current – is the only efficient solution. The other being a linear approach dissipating all power not used for light – which practically defeats the purpose of using an energy efficient light-source like LED.

Advanced LED driver / controllers use the combination of these two control strategies: advanced modulation algorithms and high frequency direct current control. Combining these two strategies results in the best of both worlds: a very high efficiency LED driver, no flicker, smooth and accurate dimming and high contrast.

Drive Intelligence

In the paragraph above direct current control is being used as part of a control algorithm for relative power levels – enhancing overall system efficiency. The same feature can also be used for setting the rated power level for the LED driver. This power level depends on which light engine the LED driver is connected to. The same way an NTC on the light engine provides feedback of actual light engine temperature, a similar 'tag' device can set the LED driver to a certain current level. This way the LED driver becomes a standard module for multiple light engines, helping manage diversity in supply chains. More importantly, it provides forward compatibility: a (hopefully large) number of years down the road the same 'tag' device on the light-engine can ensure compatibility when exchanging a light engine or driver module.

The other aspect of connecting an LED driver / controller to a light engine is the available forward voltage or V_f – what length of string of LEDs in series can be connected to a single driver output? Higher available V_f is better as many prefer single strings of LEDs above multiple strings in parallel. Actually, there are many aspects to take into account including the existing certification requirements for the lighting system. More intelligent LED drivers sense the voltage needed to drive the connected light engine and set the LED driver to the most efficient settings.

Conclusions

Today's lighting networks combine global or network (e.g. DMX, DALI) and local or fixture (temperature, daylight) inputs to ensure robust control set points throughout various operating conditions. Different LED topologies in light engines require separate combinations of voltage and current to operate the light engine at a rated light output. Of the blocks needed to build an LED lighting system, the driver / controller electronics define the feature set in terms of intelligence and networking. The driver / controller electronics partially define the light quality and overall system efficiency together with LED choice, optics and thermal design. The driver/controller electronics certainly influence the system lifetime performance through robust design and function.

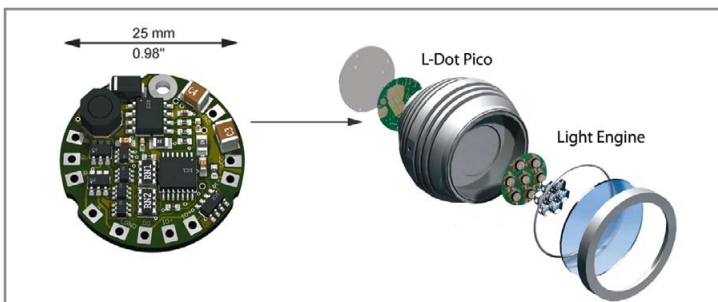

Figure 5: Intelligent electronics design allows for combining network intelligence, control intelligence and drive intelligence even in very small footprints.

Intelligent LED drivers/controllers are becoming forward compatible standard modules that combine network, local sensor and light-engine inputs, advancing the adoption of LED as the light source of choice in an ever more diverse application area. ■



More than (just) an LED Power Supply...

Vossloh-Schwabe develops and produces top-quality LED systems – from controllers to high-performance LED modules.

As the constant current devices of VS' ECXe series recently became capable of DC voltage operation within a range of 176 V to 254 V, they are now suitable for use in emergency lighting systems powered by a central battery.

For VS, this makes them far more than just LED power supplies. It turns them into stalwart guardians of operational safety.

Vossloh-Schwabe: The Visionary Side of Light



LED professional – Patent Report

> Siegfried Luger and Arno Grabher-Meyer, Editors, LED professional

Intellectual properties play an important role in the still young and highly dynamic LED area. The number of patent applications and granted patents is continuously increasing and it's time-consuming to keep an overview. Therefore, LED professional publishes the bi-monthly "*LED professional - Patent Report*", which is released in conjunction with the *LED professional Reviews*. The report covers the US & EP granted patents in the field of LED lighting for the last two-month period. Every granted patent is highlighted with: a selected drawing (Derwent), the original patent title, a specifically re-written title (Derwent), the IPC class, the assignee/applicant, the publication number and date, and last but not least the original abstract.

With the "*LED professional - Patent Report*" it's easy to screen the IP-landscape, to check the "freedom-to-operate", to check if it is necessary to file an opposition, to monitor the competition or even to get inspired to make your own inventions.

LED professional – Patent Report (LpR 18)

Period: Jan 1, 2010 – Feb 28, 2010

Regions: US, EU & DE

Application: General Lighting

Granted Patents: 178

Pages: 67

The LED professional – Patent Report is only available for *LED professional Review (LpR)* digital subscribers. If you have a valid subscription, please download the report by following this link: "[LED professional – Patent Report \(LpR 18\)](#)".

To order or renew your digital subscription: Please visit <http://www.led-professional.com/subscriptions>.

Priority Country	Grtd. Patents
US (Amerika)	80
JP (Japan)	25
KR (Korea)	19
CN (China)	12
EP (Europe)	12
TW (Taiwan)	12
DE (Germany)	11
GB (Great Britain)	3
CA (Canada)	1
IE (Ireland)	1
HU (Hungary)	1
PL (Poland)	1

Table 1: Top priority countries

Assignee	Grtd. Patents
PHILIPS	14
SAMSUNG	14
CREE INC	11
FU ZHUN PREC INDUSTRY SHEN ZHE	8
OSRAM	6
LG	4
SEOUL SEMICONDUCTOR CO LTD	4
AVAGO TECH ECBU IP SG PTE LTD	3
HK APPLIED SCIENCE & TECH RES	3
ILIGHT TECHNOLOGIES INC	3
NEOBULB TECHNOLOGIES INC	3

Table 2: Top assignees

IPC-Main	Grtd. Patents	IPC Description
H01L	64	Semiconductor Devices
F21V	43	Functional Features or Details of Lighting Devices
H05B	12	Electric Lighting
F21S	11	Not-Portable Lighting Devices
H01J	7	Electrica Discharge tubes
G05F	5	Systems for Regulating Electric or Magnetic Variables
G02B	5	Optical Elements, Systems, or Apparatus
G09G	4	Arrangements or Circuits for Control...
G02F	3	Devices or Arrangements, Optical...
G01J	3	Measurement of Intensity,...

Table 3: Top technologies based on IPC-R(4 digits) codes

Inventor	Grtd. Patents
Lu, Ming	3
Bierhuizen, Serge J.	2
Chen, Jeffrey	2
Hulse, George R.	2
Lee, Jeong-wook	2
Loh, Ban P.	2
Sakai, Shiro	2
Villard, Russell George	2
Wang, Bily	2

Table 4: Top Inventors

photonflame



photonflame

The NEW concept in LED LIGHTING

Outperforms conventional LED LIGHTING

Brighter than CFL

360 degrees light output possible

Wide range of new applications

Patented technology

The ultimate "green" light source

New dimensions for LIGHTING DESIGNERS

New light power for BULB MANUFACTURERS

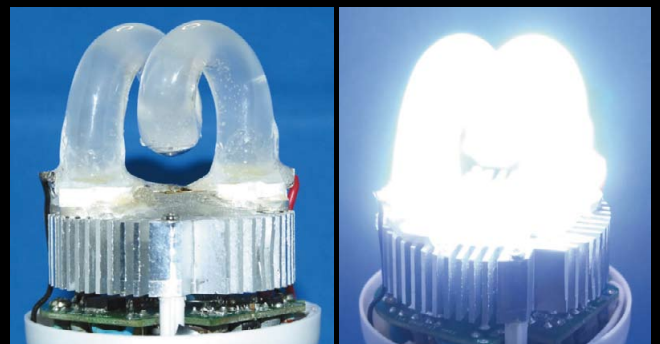

For more information:
www.photonflame.com
www.luxelium.com

LOK-F GMBH
Ringstr. 21
D-56307 Dernbach
Germany

Industriepark Urbacher Wald
Tel.: (+49) 2689 9794-50
Fax: (+49) 2689 9794-53
info@photonflame.com

PLEASE NOTE: All photos show laboratory prototypes!

We help you to design your new product.

a world of bright ideas®

TRIDONIC.ATCO

light+building 11. – 16. April 2010

We highlight your ideas!

Not only for grand projects, but also within the scope of reliable standard solutions. Visit us at light & building 2010, stand 2.0 A30, and let yourself be inspired by our new and existing products for intelligent lighting solutions.

Burj Khalifa, Dubai, too, is illuminated by products from TridonicAtco

