

LED
professional

www.led-professional.com

ISSN 1993-890X

Review

LpR

The technology of tomorrow for general lighting applications

July/Aug 2010 | Issue

20



LED Defect Analysis
LED Luminaire Lifetime
Selection Criteria for Miniature Spectrometers
Distributor Report - Arrow

Imagine...

the Perfect Picture

Your Imagination: 76,500 excited fans watching an instant replay of their team on a gigantic 1750 inch flat-panel LED scoreboard thinking that's the Perfect Picture.

Our Innovation: Avago's LEDs are the world's brightest for Electronic Signs and Signals.

- Super wide viewing angle of 115°–120° including a built-in reflector that increases the intensity of the light output.
- The black top surface and full black body of the LED deliver enhanced contrast for color sign applications.
- Water-resistant (IPX6) design for environmentally harsh applications.

If a commitment to technical excellence and innovative solutions in Signs and Signal applications is critical to your design, contact Avago for a free sample:

www.avagoresponsecenter.com/433



AVAGO
TECHNOLOGIES

Your Imagination, Our Innovation

Reliability Unknown?



We all know the 50,000 hour life-time figure which is claimed nearly everywhere when LEDs are used as light sources. What about the boundaries for this value and the system reliability including the behavior of all the system components? Are they unknown?

Lifetimes of traditional light sources as incandescent, fluorescent, and high-intensity discharge lamps are estimated using industry-standard lamp rating procedures. Typically, a large, statistically significant number of lamps are run until 50% have failed. That point, in terms of operating hours, defines "rated life" for that particular lamp. LED technology changes several aspects of this traditional approach in that LEDs usually do not fail abruptly like traditional light sources; instead their light output slowly diminishes over time.

LEDs are often integrated permanently into the fixture, making their replacement difficult or even impossible. LED light sources can have such long lives that life testing and acquiring real application data on long-term reliability becomes problematic – new versions of products are available before current ones can be fully tested.

LED light output and useful life are highly dependent on electrical and thermal conditions that are determined by the luminaire and system design. The life-time or reliability claims are based on the estimated lumen depreciation of the LED used in the product and often do not account for other components or distributions of multiple LEDs. Did you know, for example, that the very rare catastrophic failure of an LED always occurs as a short circuit on flip-chip LED technologies because there is no bond wiring? Are you aware of L70 and B50 figures? And what about an array of LEDs – can we use the maintenance figures of a single one?

The unhappy situation of missing clear reliability figures for SSL products is one of the reasons for deeper investigations in this area by LED manufacturers, luminary producers and also government departments.

A lot of questions arise from this situation. LED professional wants to dig into this topic and let the experts express their views. We would also like to know what your opinion about SSL product reliability is.

We would very much appreciate your feedback about LpR. Let us know what you like or tell us how we can improve our services. Please keep in mind that you are also welcome to contribute your own editorials.

Yours Sincerely,

Siegfried Luger

Publisher

Imprint

LED professional Review (LpR)
ISSN 1993-890X

Publisher

Luger Research e.U.
Institute for Innovation & Technology
dep LED professional
Faerbergasse 15, Haus Rot
A 6850 Dornbirn, Austria / Europe
phone +43 5572 394 489
fax +43 5572 394 489 90
editors@led-professional.com
www.led-professional.com

Publishing Editors

Siegfried Luger
email s.luger@led-professional.com
phone +43 5572 394 489 70

Arno Grabher-Meyer
email a.g-m@led-professional.com
phone +43 5572 394 489 18

Account Manager

Theresa Koenig
email theresa.koenig@led-professional.com
phone +43 5572 394 489 20
fax +43 5572 394 489 90

Local Contacts

<http://www.led-professional.com/contact-us>

Front-page picture

alphaLED Downlight
Photo: A. Grabher-Meyer
Artwork: Thomas Klobassa
©LED professional 2010

Copyrights – Luger Research e.U.

The editors make every reasonable effort to verify the information published, but Luger Research e.U. assumes no responsibility for the validity of any manufacturers, non profit organisations or individuals claims or statements. Luger Research e.U. does not assume and hereby disclaims any liability to any person for any loss or damage caused by errors or omissions in the material contained herein, regardless of whether such errors result from negligence, accident or any other cause whatsoever. You may not copy, reproduce, republish, download, post, broadcast, transmit, make available to the public, or otherwise use LED professional Review (LpR) content without prior written consent from Luger Research e.U. – Institute for Innovation & Technology, Austria. ■



LED professional Review (LpR) - Annual Subscriptions

LpR Digital Magazine

- 6 issues
- pdf download
- high resolution pictures and graphs
- printable
- commercial use
- access to all previous issues
- Euro 78.80
- <http://www.led-professional.com/subscriptions>

LpR Printed Magazine

- 6 issues
- Euro 158.40

Next LpR Issue - Sept/Oct 2010

- LED Primary & Secondary Optics

Content

Editorial	p1
Imprint	p2
Product News	p5

■ Characterization

LED Luminaire Lifetime: Recommendations for Testing and Reporting by DOE Lifetime and Reliability Working Group	p22
Comparison of Test Results from Different Korean Testing Laboratories by Dong-Hoon Lee et al., Korea Research Institute of Standards and Science	p24

■ Technology

LED Failure Modes and Methods for Analysis by Holger Pross, RoodMicrotec GmbH	p28
---	-----

■ Optics

Considerations for Choosing a Miniature Spectrometer for LED Measurements by Ryan M. Flaherty, Jason D. Pierce, Michelle Dean Ritchie, StellarNet, Inc.	p32
---	-----

■ Drivers

Traffic Lights and Signage Need Intelligence by Alex Zaretsky, Renesas Electronics Europe	p38
---	-----

■ Special Topics

Distributor - Arrow: From Drivers to Diodes - All from One Single Source by Stephan Wegstein, Arrow Central Europe GmbH	p42
---	-----

Advertising Index

Avago Technologies	p	C2
Taitronics	p	4
Infineon	p	7
CREE	p	9
OSRAM	p	13
Ocean Optics	p	17
Signcomplex	p	19
Electronica	p	19
Bodo's Power Systems	p	21
Instrument Systems	p	25
Middle East Electricity	p	31
Light Middle East	p	33
Kingbright Electronic	p	36
LED Fair	p	37
Forum LED	p	39
CIOE Fair Shenzhen	p	41
LED Light for You	p	44
Arrow Electronics	p	C3
Tridonic	p	C4



TAITRONICS

36th Taipei International Electronics Show

LED · Electronic Components
Test & Measurement · Processing

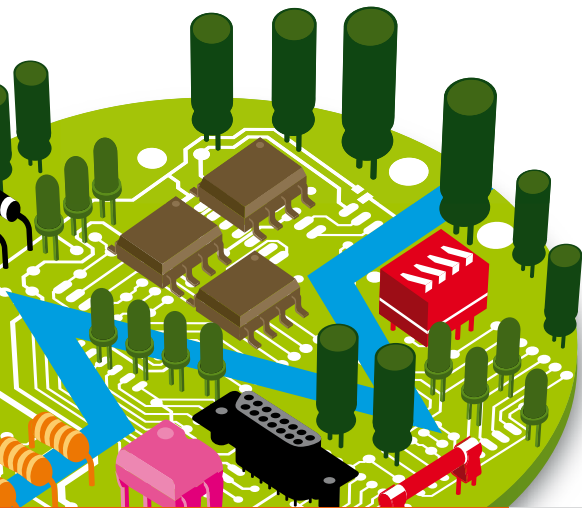
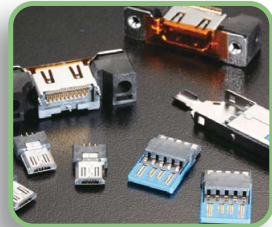
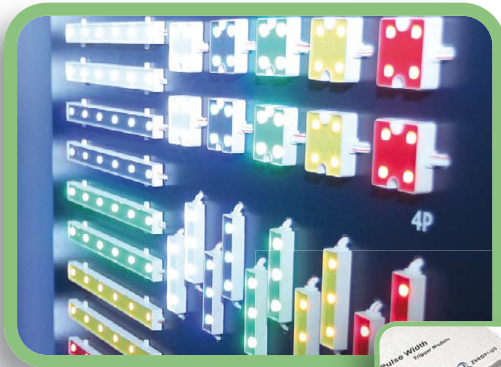

To learn about our **Buyer's Incentive Program**,
please find your nearest TAITRA office online:
<http://branch.taiwantrade.com.tw>

2010
October 11-14

TWTC Nangang Exhibition Hall **TAIPEI, TAIWAN**

Co-located:  Taiwan RFID
 Broadband Taiwan

Organizers:  TAITRA
 TEEMA

www.TAITRONICS.org

Product News

JKL Components Announces New High CRI LEDs

JKL Components Corporation announces the ZSM-6550-C LED series - a complete range of high output, high CRI series of white LEDs used in any application requiring a CRI above 90.



With a CRI above 90, the new ZSM-6550-C LED series can be used for any application.

With a median output of 66 lumens and very narrow deviation in both brightness and color, this LED product line eliminates the need for controlling lot variations and consistency, putting our product at the forefront of LED technology.

The ZSM-6550-C series is an excellent choice when accurate imaging is a primary design need, such as for medical and dental procedures, special effects and cosmetic applications. Art and artifact viewing with realistic rendering without the risk of UV exposure are also well suited for the use of the ZRI series.

The footprint of the ZSM-6550C-LED is 5.4 x 6.5 mm with a low profile of 1.65 mm. These high output LEDs have eight options for color temperature, ranging from 2700 - 6500 Kelvin. ■

LUMEX Expands TitanBrite Line of High Power LEDs

Lumex announces the extension of their TitanBrite line of high power LED technology with the introduction of new 2-watt, 3-watt and 5-watt LEDs. The surface mounted LEDs provide high intensity light of up to 58, 210 and 300 lumens, respectively. Compared to similar high power LEDs, the new TitanBrite products can provide up to a 30% improvement in heat dissipation performance and a 60% enhancement in electrostatic discharge protection. The technologies feature unique packaging which allows for simplified integration and for additional savings in the area of product design.



The new 2-watt, 3-watt and 5-watt high power LEDs from Lumex provide up to a 30% improvement in heat dissipation performance and a 60% enhancement in electrostatic discharge protection.

Compatible with standard LED drivers, the new TitanBrite 2-watt, 3-watt and 5-watt LED technologies are ideal for a wide range of applications that require bright, intense light with low power consumption. Applications include: automotive, decorative, landscape, small space and emergency lighting as well as backlighting and incandescent lamp replacement.

The new TitanBrite LEDs provide superior heat dissipation performance and electrostatic discharge protection compared to similar high power LED products. Whereas a standard high-power LED provides thermal resistance of 10°C/watt, the new TitanBrite products can provide thermal resistance as low as 7°C/watt. Traditional high power LED technology provides electrostatic discharge protection up to 5,000 volts compared to 8,000 volt protection provided by the new TitanBrite technology.

The new 2-watt, 3-watt and 5-watt high power LEDs also feature unique packaging that simplifies integration processes. Whereas traditional high-power LEDs require an additional heat sink or metal core PCB to control thermal dissipation, the unique packaging of the new TitanBrite products allows for the elimination of the metal core PCB and instead fuses to a lead frame to manage thermal output. This simplifies product design and reduces the number and cost of ancillary materials required to make the product perform.

TitanBrite high power LED technology comes with complimentary integration support. Lumex Technical Design Specialists can integrate TitanBrite LEDs with LCDs, light pipes, switches, connectors and other key components to create solutions that maximize performance and efficiency in each individual application.

The RoHS compliant TitanBrite 2-watt, 3-watt and 5-watt LEDs are available in a variety of colors. The 2-watt technology is available in yellow (591 nm type) and red (623 nm type). The 3-watt and 5-watt LEDs are offered in blue (465 nm type), warm white (2700 K) and cool white (6000 K) with red, green and yellow versions also available at no additional cost.

The compact size of the new high power TitanBrite LEDs enables important real estate savings in product design. The 2-watt TitanBrite LED (SML-LXL8047XXX/2) is available in both a round 8mm package as well as a square 9 mm package. The 3-watt TitanBrite LED (SML-LXL8047XXX/3) is available in a round package with 8 mm diameter. The 5-watt TitanBrite LED (SML-LXL99XXX/5) features a 9 mm squared package with 7.7 mm diameter. The square package of the 5-watt LED allows for increased design efficiency with easier assembly and array formation opportunities. ■

LED Light Precisely Focused

Unlike conventional lighting systems that radiate their light all around, LEDs already have the advantage that they emit their light under defined angles of radiation. This reduces divergence losses to a minimum. However, as a rule, optics are necessary to focus and distribute the light cones from LEDs according to the requirements of the light manufacturer.



Sharp Europe now offers "encapsulated Zenigata" LED modules.

To demonstrate a suitable system approach for LED lighting applications, Sharp offers far more than just its LED component portfolio. Supported by optic specialists IdeaLED, DFO and LEDiL, the Japanese company will also be introducing the appropriate optics designed especially for the DoubleDome, Zenigata, and MiniZeni series types. The bandwidth of the lenses suitable for Sharp LEDs is broad and ranges from selectively focused spotlights to broader spotlights with angles of radiation of about +/- 30°. Even lenses for lamps with three and more LEDs and different attachment methods – screwing, gluing, clipping – are available in the product lines from Sharp's partners.

IdeaLED has even developed a process for the Zenigata modules to connect the optic directly to the module, thus encapsulating the LED module. These so-called "encapsulated Zenigata" LED modules can be used directly as lighting for downlights, for example.

To achieve this product diversity, both optic specialists rely on lenses made of special plastics that are designed for temperatures of well over 100°C. Compared to reflector-based optics, lens systems generally have two advantages. First of all, most lenses are more efficient because all of the LED light is guided through the lens and concentrated there while in the case of reflectors, the portion of light that does not hit the reflector is radiated out, and not concentrated. Secondly, lenses can protect the lighting equipment against dust, dirt, spray water, and mechanical loads so that with lenses, lamps can easily achieve the IP 65 safety class. Lenses also offer pricing advantages because expensive galvanisation processes for coating reflectors and covering the optic lens with protective glass are not necessary.

Compared to glass lenses, plastic lenses also have the advantage of being lighter in weight, more malleable and easier to process. Due to the combination of different lens geometries, light cones can also be purposely shaped into lines or crosses, for example. For large quantities, plastic lenses are additionally considerably less expensive than comparable optics made of glass. ■

New LUXEON REBEL LEDs Set Benchmarks for Illumination

Philips Lumileds announced the release of two new LUXEON Rebel LEDs with correlated color temperatures (CCTs) of 2700K and 3000K that expand the company's portfolio for indoor illumination applications in hotels, shops, restaurants, and homes. The new emitters use the latest thin film flip chip (TFFC) and proprietary Lumiramic phosphor technologies. At the high operating temperatures found in applications like recessed lamps, the new emitters set efficacy benchmarks. The implementation of Lumiramic phosphor technology is reducing the white binning space, advancing the company's drive to free customers from white color binning, provides superior color uniformity and raises the standard for quality of light.

New LUXEON Rebel Emitter Highlights

- Typical efficacy of 80 lumens per watt and up to 95 lumens per watt at 350 mA and 3000 K CCT
- Consistent efficacy across the typical operating temperature range
- Specified CRI—typical 85
- Industry's smallest and most consistent, white binning space
- Only power LED with specified color over angle performance
- Superior light output performance at application conditions

Shrinking White Color Distribution by a Factor of 4

For a decade, white binning has complicated luminaire design. Philips Lumileds is using Lumiramic phosphor technology to dramatically reduce the white binning space. With over 80% of the emitter production falling within a 3 MacAdam ellipse area within the ANSI bin space, luminaire design is simplified, unit-to-unit consistency is reality, and the supply chain is more certain and reliable.

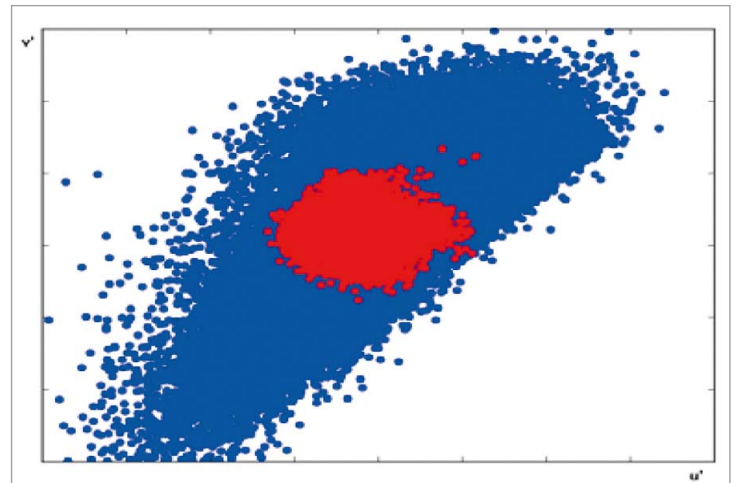

Area in red indicates distribution of LUXEON Rebel LEDs using Lumiramic phosphor technology. Area in blue is a standard distribution of white LEDs.

Efficacy at high temperature application operating conditions

Stable efficacy at virtually all temperatures and superior efficacy at actual operating conditions are hallmarks of the new LUXEON Rebel emitters. While LEDs are typically tested at 25°C, in applications like down lights and retrofit lamps, the internal temperature will be much higher and may be as high as 80°C-100°C. While most LEDs would have significant light output and

efficacy losses at these temperatures, the new LUXEON Rebel emitters maintain more than 90% of their light and more than 95% of their datasheet efficacy— even at a junction temperature of 85°C.

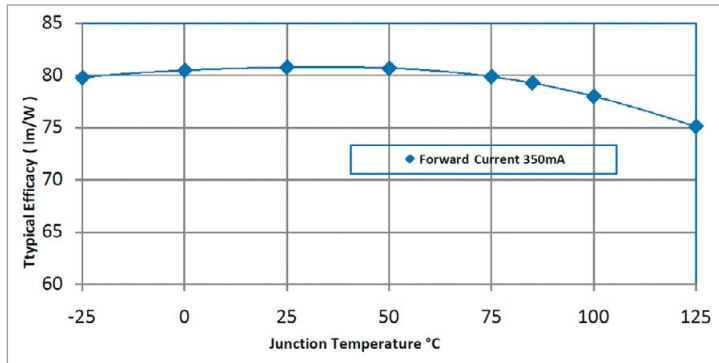

The new LUXEON Rebel emitters maintain more than 95% of their datasheet efficacy at a junction temperature of 85°C.

High color rendering and the smallest possible color over angle variation

Color rendering is also improved by the application of Lumiramic phosphor plates and is now being specified with typical CRI of 85 for both the 2700 K and 3000 K CCT emitters. Illumination of retail goods, food products and skin tones are all very good at this level and peoples' perception of the light is positive and confident.

Most LEDs display inconsistent color off the center viewing axis because the blue photons pass through varying thicknesses of phosphor before exiting the LED and therefore have different color qualities. This is particularly problematic in linear or wall wash applications so prevalent in the hospitality industry. To provide dependable, consistent color and tint at a wide range of viewing angles, Philips Lumileds has implemented a unique process in conjunction with its Lumiramic phosphor that allows decreased variance in color over angle. This breakthrough not only contributes to overall color quality, it delivers consistent, repeatable results so that lighting designers can confidently design for the most demanding applications. ■

Everlight Introduces the New Shwo LED Lighting Series

Expanding Everlight's Lighting Series component portfolio, Everlight Electronics introduces another high power, high brightness LED package, the "Shwo" Series - our powerful, bright and economic (superb \$/lm) LED series in a compact ceramic package.

The Shwo series is a surface-mount high-power device featuring high brightness combined with a compact size (3.5x3.5x1.85mm) that is suitable for all kinds of lighting applications such as general illumination, flash, spot, signal, industrial and commercial lighting.

With the capability of 100~700mA driving currents, the Shwo family can be driven up to 3 watts. The minimum luminous flux (lm) of the 1W Shwo can be up to 100 lm at 6500K(CCT) or 80 lm at 3000K(CCT) when driven with 350mA current. The minimum luminous flux (lm) of the 3W Shwo can be up to 160 lm at 6500K(CCT) or 120 lm at 3000K(CCT) when driven with 700mA current.

The thermal pad of this device is electrically isolated providing convenience in thermal and electrical design. The Shwo series also has the advantage of low thermal resistance. It is one of the most promising devices in Everlight's high power Lighting Series product offering and is ready to face the challenges of today's Solid-State Lighting requirements.

Everlight is also promoting closer working relationships between the R&D, Sales and Marketing teams to better meet and exceed our customer's expectations in both product offering and technology perspectives. The Shwo LED series and its many technical features are a result of fostering a closer relationship between these teams.

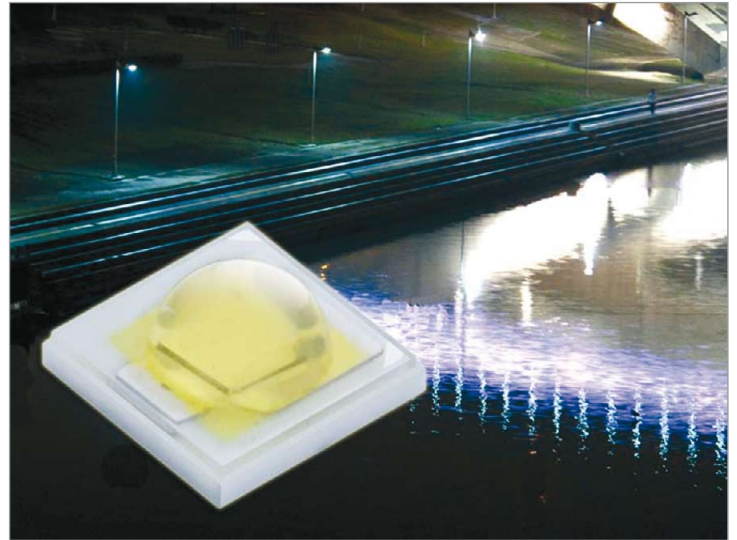

Shwo [Shuo] is the English translation for the Chinese word meaning Twinkle and is often used as a description of stars.



Driving 0.5W LEDs on light strips with dedicated Infineon LED drivers

Low cost solution for driving 0.5W LEDs with BCR 320U / BCR 321U or BCR 420U / BCR 421U

Our new application note AN212 describes how to drive medium power LEDs simple and cost-efficient in typical light strip applications with dedicated LED drivers for 0.5W LEDs from Infineon.

Key Content & Application Hints

- Suitable 0.3W – 0.5W LEDs for the BCR 32xU / BCR 42xU
- How to easily set the exact current needed by the LEDs
- Dimming multicolor LEDs (RGB) with BCR 321U / BCR 421U and a microcontroller
- Paralleling multiple BCR 32xU LED drivers for higher power LEDs
- Using BCR 32xU / BCR 42xU at higher supply voltages

www.infineon.com/bcr32x_lp

Features:

- Small package with high efficiency
- ESD protection up to 8 kV
- Soldering method: SMT
- Binning Parameters: Brightness, Forward Voltage, Wavelength and Chromaticity
- Moisture Sensitivity Level: 1
- RoHS compliant
- Matches ANSI binning
- Lumens Maintenance conforms to IESNA LM80 test method

Applications:

- General Lighting
- Decorative and Entertainment Lighting
- Signal and Symbol Luminaries for orientation marker lights (e.g. steps, exit ways, etc.)
- Exterior and Interior Automotive Illumination

Samples are available now and mass production will start end of second quarter 2010. ■

OptoDrive LED Modules Comply with Cyanosis Observation Index Directive

The OptoDrive SVEA 15W-LED medical module 4300K has recently been introduced and was tested by an independent test institute. Results have confirmed its suitability for Australian hospitals and medical tasks that are required to comply with the Cyanosis Observation Index (COI) as per AS1680.2.5:1997. This is an important standard that takes into account the strict guidelines that apply to the use of lamps in the diagnosis of patients in hospital wards, medical clinics and associated areas. Tasks can vary from general medical examination to minor surgery.



The OptoDrive SVEA is a complete compact light module for medical applications, comprising lens, driver and LEDs.

Description of Cyanosis Observation Index (COI)

The bluish discoloration in skin and mucous membranes indicates that the oxygen levels in the blood are dangerously depleted. Without a good transmittance in the red area (660nm) this could be undetected. The visual detection of cyanosis is related to the differences in the spectral transmission of oxyhaemoglobin and reduced haemoglobin which is maximized at about 660nm.

- If a lamp output at 660nm is too low a patient's skin color may appear darker and may be diagnosed as cyanosed when this is not the case.
- If a lamp output at 660nm is too high it may mask the cyanosis and it may not be diagnosed when it is present.

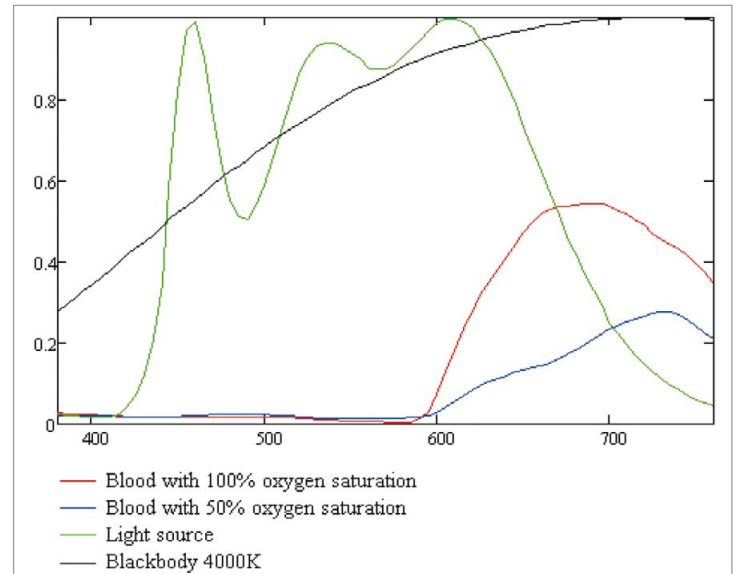

The graph shows the spectral light distribution of light sources and the difference in colour of saturated and unsaturated blood.

Optodrive LED Modules

provide a superbly balanced light and excellent color reproduction. Many tasks demand extra accuracy in color perception, having achieved a Color Rendering Index value (CRI) which exceeds the standards of workplace lighting. OptoDrive LED modules provide the solution for many applications apart from medical lighting. To name a few – food retailing, art galleries, fashion/clothing displays.

It should be noted, aside from OptoDrive LED's many other types of LED's have focused their development on brightness rather than color rendering and consequently most of the LED's available today have the disadvantage of not appearing like natural light. The OptoDrive product range is made up of 3 product platforms: SVEA – Clara – Felicia.

All of the OptoDrive LED module range is becoming increasingly popular because of their compact dimensions - high illumination performance - colour temperature - Colour Rendering Index (CRI) - range of beam spreads (controlled by special lens and reflector designs) - cool - lack of IR and UV radiation - efficient/energy saving - long service life.

In addition to all of the above features OptoDrive LED modules have been purposely designed to suit a wide range of light fittings e.g. task lights, downlights, spotlights etc. Optodrive LED module are used in Europe, the UK, USA and most recently, Australia. ■

★ CREE XLAMP® LEDs ARE SIMPLY THE

BRIGHTEST

MOST ENERGY-EFFICIENT LEDs AVAILABLE.*

★ LIGHTING THE LED REVOLUTION™



“AVAILABLE” MEANS—YOU ORDER THEM, WE SHIP THEM.
THAT PART IS SIMPLE TOO.

Find a Cree Solutions Provider or authorized distributor at
www.cree.com/xlamp or call 800-533-2583.



up to **1500** lm
@ 20W
XLamp®
MP-L LEDs



up to **855** lm
@ 10W
XLamp®
MC-E LEDs



up to **493** lm
@ 5W
XLamp®
XP-G LEDs

CREE 

Photo depicts an actual installation using Cree XLamp LEDs. Cree, XLamp and the Cree logo are registered trademarks, and Lighting The LED Revolution is a trademark of Cree, Inc.

Tridonic Introduces TALEXEngine SPOT and FULMEN

Two new additions to the TALEX lighting systems from Tridonic are TALEXEngine FULMEN and TALEXspot LED.

TALEXEngine FULMEN consists of an LED module, lens optics and a heat conducting mounting plate which, together, produce a suitable light source for spotlights and a direct, energy efficient replacement for LV halogen lamps in spotlights. The new TALEXspot modules have been designed specifically for use in downlights or spotlights as a replacement for CFL's, LV halogen lamps or lower wattage metal halide lamps.

There are two TALEXEngine FULMAN options available, 15 W and 27 W, whilst a choice of lenses with 15° and 25° beam angles and colour temperatures of 3,000 or 4,200 K, allow fine tuning of accent lighting. TALEXEngine FULMAN range offers two versions for 'warm' or 'cold' applications, each offering low energy consumption and no UV or IR radiation.

TALEXEngine FULMAN 15W can be used in conjunction with TALEXconverter 0030 K700 to replace a 35W halogen lamp, whilst TALEXEngine FULMAN 27W together with 0030 K700 one4all can replace a 50W halogen lamp.

TALEXspot LED's have durable components, a life of 40,000 hours and are suitable for exterior applications. There are three versions of the new TALEXspot modules; TALEXspot with 27 light points, TALEXspot 3000 with 36 light points and TALEXspot 4000 with 48 light points, all providing luminous flux of 2,000, 3,000 and 4,000 lm respectively.

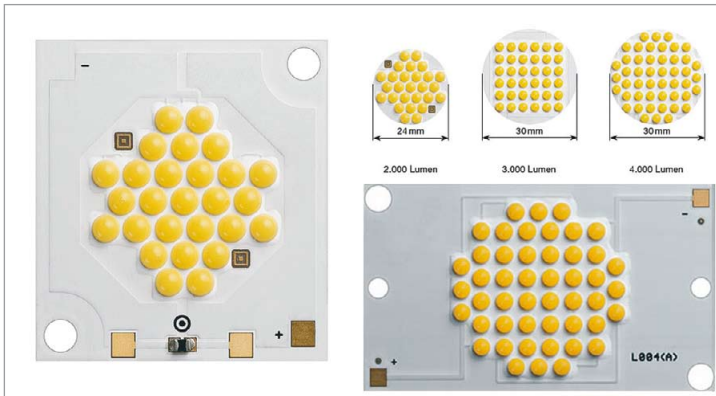

Talex modules are now also available in rectangular dimensions.

These rectangular modules have compact dimensions of 55 x 40 mm for the two larger versions and 40 x 30 mm for the smaller, making them ideal for integration into compact luminaires. The two available colours of neutral white (4000 K) and warm white (3000 K) provide an excellent basis for targeted illumination.

These new products from Tridonic combine advanced, energy efficient technology to provide the user with an invaluable tool for a wide range of lighting projects. ■

Edison Opto Announces Four Types of Streetlight Modules

Edison Opto offers four types of streetlight modules for various requirements. As the application with LED streetlight modules gradually becomes a global trend, Edison Opto has introduced four LED streetlight modules satisfying various roadway requirements.

Featuring the 12W Edixeon module with three choices of optical patterns: 135°×50° and 130°×40°. Utilizing high thermally conductive metal core PCB, the secondary lens is coupled with IP-68 capability. Besides the Edixeon module, the 27-watt Federal module is composed of 24 high-power Federal components, with a lumen output up to 2,160 lm. The asymmetric lens design for the Federal module offers an alternate choice for high power streetlight modules.



Edison Opto's new line of LED streetlight modules promise a solution for different requirements.

With the government's policies, there are variable standards for streetlights. Most standards strictly regulate the road width, the height of the streetlight, CRI and the average luminance. Edison Opto utilizes a highly efficient multiple non-spherical lens design to achieve different beam patterns and uses asymmetric light output to minimize glare. This lens technology can be applied to all kinds of LED lights or traffic lighting and other non-symmetrical illumination for multiple applications. ■

GLT: Edge-Lighting Technology for Troffer Downlights

Global Lighting Technologies (GLT) has combined its edge-lit LED light guide technology with its mass production capabilities to create a new troffer downlight that is slim, light, efficient, and can be cost effectively manufactured in high volumes.

The troffer backlight utilizes advanced light extraction technologies to extract light precisely where needed, providing bright, uniform light in a thinner form factor without hot spots or dark areas. The LEDs are spaced along the edge of the troffer assembly against the light guide to create an assembly measuring 23.5" x 23.5", 0.35" thick, having less than 3 kg (6.6 lbs.).

GLT's edge-lighting approach achieves maximum efficiency in light dispersion, with the product now in production having a brightness of 24 lumens at an output of 400 ± 30 lux @ 2 m, a color temperature of 4000 K/6000 K, and power consumption of 45 W. Future production modules will be even more efficient.

"Illuminating this troffer with the traditional fluorescent tube technology would have resulted in an assembly up to 5 inches thick," according to Brett Shriver, GLT's Director of Sales. "Our approach yields a much slimmer, more lightweight, higher intensity backlight with an LED lifetime of about 30,000 hours, and with three production facilities in China and Taiwan, we bring the advantages of mass production to a product that heretofore has been an expensive 'one-off' where the light guide had to be manufactured for each troffer. We can make them in the thousands with no differentiation from troffer to troffer."

And, since LEDs contain no mercury, the edge-lit troffer is an environmentally friendly solution as well. It also reduces maintenance and power consumption and, when compared to a direct backlighting approach using LED arrays, minimizes thermal management issues as well as the number of LEDs required for efficient, uniform light dispersion. ■

New Operating Lighting from Enfis and C-THME

The latest collaboration between UK-based LED Manufacturer, Enfis and Chinese medical lighting specialist C-THME heralds a step-change in surgical lighting technology.

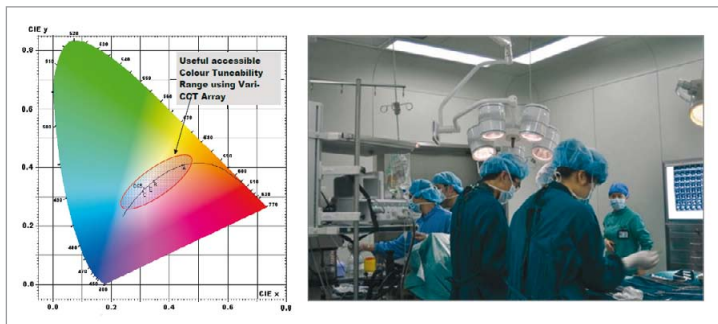

The new lighting system in use at a Teaching Hospital with CRI > 90.

The new C-THME light offers:

- Colour Rendering Index (CRI) >90; and
- Constant light output over a wide range of correlated colour temperatures (CCTs).

It uses the Enfis UNO Plus High CRI Vari-CCT light engine with narrow-beam optics, and has two major advantages over the first generation variable-CCT discrete LED systems:

Major advantages:

- The Enfis LED Array mixes the colours required to achieve the CRI/CCT range within one package - no colour banding, separation or shadowing
- Multiple 'lamp heads' with airflow through the light centre - improving the air quality and temperature around the patient

Precise, tunable lighting in operating theatres contributes to patient safety by enabling surgeons to identify small differences in tissue and also 'tune' the light to match their individual eye response. This also reduces surgeon fatigue and shortens operating times.

Swansea-based Enfis produced a tailored LED light engine and this was combined with a unique fixture design by China-based C-THME to create the ground-breaking new product.

This new lighting technology delivers efficient, powerful, widely tunable light with no colour separation or shadowing. ■

GE LED Retrofit Lamp: First Led Energy Saving Trust Approval

The 4W GU10 LED from GE Lighting is the first retrofit LED lamp to gain approval by the Energy Saving Trust's product certification scheme. Consuming only 4 Watts of power and allowing 80% energy savings to be achieved, this landmark approval demonstrates GE Lighting's commitment and vision to deliver groundbreaking lighting technology that saves energy; maintenance costs and reduces environmental impact.



The 4W GU10 LED from GE Lighting gained approval by the Energy Saving Trust's product certification scheme.

The GU10 LED lamp is now an Energy Saving Trust Recommended certified product. Designed to retrofit international standard size and shape reflector lamps, the GU10 LED lamp opens the door to dramatic energy savings and maintenance cost reductions, with a rated lifetime of 15,000 hours.

Unlike other retrofit LED lamps on the market, the GU10 LED lamp has been shown to meet a variety of stringent criteria set by the Energy Saving Trust including beam angle, candela, colour rendering, power factor, colour temperature and physical size and shape. The Energy Saving Trust Recommended scheme only certifies the highest performing products that make a significant contribution to energy savings. All products have to be verified by third party test laboratories to gain Energy Saving Trust Recommended approval. "We are delighted with the approval from the Energy Saving Trust and it is a significant milestone in the evolution of LEDs," explained Mike Barrett, Commercial Director, UK & Nordic Region at

GE Lighting. "This is the first time an LED lamp has been awarded approval by the Energy Saving Trust Recommended scheme and GE Lighting has set a high standard for the industry by demonstrating what high quality, well designed LEDs in the appropriate application can achieve."

The 4W retrofit GU10 LED lamp is just one product in a range of LED retrofit lamps from GE Lighting. The company has long pioneered advanced lighting technologies with higher efficiency, reduced maintenance costs and less environmental impact. The approval of its GU10 LED lamp by the Energy Saving Trust is a testament to GE Lighting's Ecomagination initiative to bring new technologies to the market to help solve the world's toughest environmental challenges. The Energy Saving Trust Recommended scheme's Category Marketing Manager, Toni de la Motta states, "We are pleased that GE lighting has taken this step to be the first manufacturer to certify an LED lamp on the scheme. This will undoubtedly help us to meet our objective of reducing carbon emissions from the household sector by making the most energy efficient products available to consumers." ■

ZMDI Enters the LED Market: Energy Efficient LED Driver ICs

ZMD AG, a global supplier of analog and mixed-signal solutions for automotive, industrial, and medical applications, announced its entry into the LED market with the first three energy-efficient LED driver ICs of a new family. The drivers achieve up to 95% efficiency and demonstrate ZMDI's commitment to green technology.

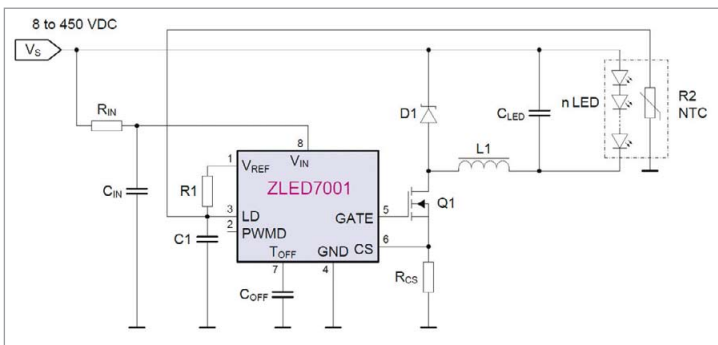

Application example schematics for the ZLED7001 universal LED driver.

"LEDs are very energy-efficient light sources and ZMDI has the mixed-signal expertise to deliver LED driver solutions which maximize the potential of these efficient light sources", says Carlo Rebughini, Vice President Worldwide Sales & Marketing at ZMDI. "Our new integrated devices make it possible for companies to build cost-effective LED lighting solutions for home, consumer and industrial lighting applications."

ZMDI's LED driver portfolio is designed for all types of internal and external lighting applications. The ZLED7000 and ZLED7010 drive single or multiple LEDs from a supply voltage range of 6 to 40 volts, using continuous-mode inductive step-down converters. The ZLED7001 is a peak current mode control LED driver which operates within a wide input range from 8 VDC to 450 VDC or 110 VAC / 220 VAC, making it ideal for direct line-powered applications. All three devices have a very small footprint and are highly integrated thus enabling a very low bill of materials (BOM) cost.

The ZLED7000 and the ZLED7010 LED driver both feature an integrated current-switching transistor and require only four external components for a complete driver. Both support wide-range dimming. The ZLED7010 also has integrated LED temperature compensation to ensure that the LED lifetime is maximized. The measured temperature information for the compensation can be cascaded through the ZLED7010 to serve up to 13 LED drivers. Both devices can drive up to 750 mA of LED current, and feature regulation better than 2 mA. This means the LEDs deliver consistent, flicker-free brightness.

For line-powered applications, the ZLED7001 universal LED driver allows efficient operation of High Brightness (HB) LEDs with voltage sources ranging from 8 VDC to 450 VDC, including rectified 110 VAC / 220 VAC. Direct connection to the power line dramatically reduces the cost and size of LED lamps, and makes it possible to create LED lamps which are direct replacements for conventional incandescent and fluorescent lamps. The ZLED7001 delivers excellent dimming response and can be dimmed using either Pulse-Width-Modulation techniques or via a linear input control pin. A temperature-compensation input can be used to ensure maximum LED lifetime.

For all three devices, full application kits including application notes and an evaluation board are available now. The ZLED7000 comes in a SOT89-5 package, making it ideal for space-constrained applications such as signage or special architectural lighting. The ZLED7001 and ZLED7010 are available in a SOP-8 package. For 1000 pieces, the ZLED7000 is priced at 0.36 €, ZLED7001 at 0.40 € and ZLED7010 at 0.63 €. All three devices are available in mass production now. ■

ON Semiconductor: NCL3001 LED Driver Improves System Efficiency

ON Semiconductor a premier supplier of high performance, energy efficient silicon solutions for green electronics announced the further expansion of its solutions for LED lighting with the introduction of an offline LED driver that integrates power factor correction (PFC) and isolated step-down AC-DC power conversion in a single stage. By eliminating the need for a dedicated PFC boost stage, the NCL30001 offers a reduced component count, lower cost solution that supports higher overall system efficiency in LED power supplies for applications such as LED-based street, low bay, wall packs, and architectural lighting.

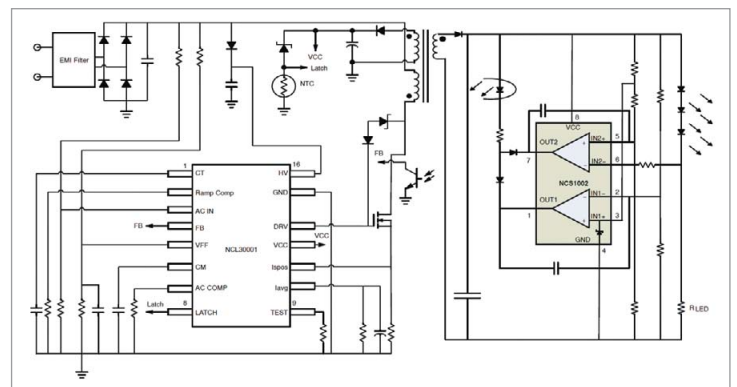

Typical application schematic using ON Semiconductors new NCL3001 LED driver IC.

www.osram-os.com

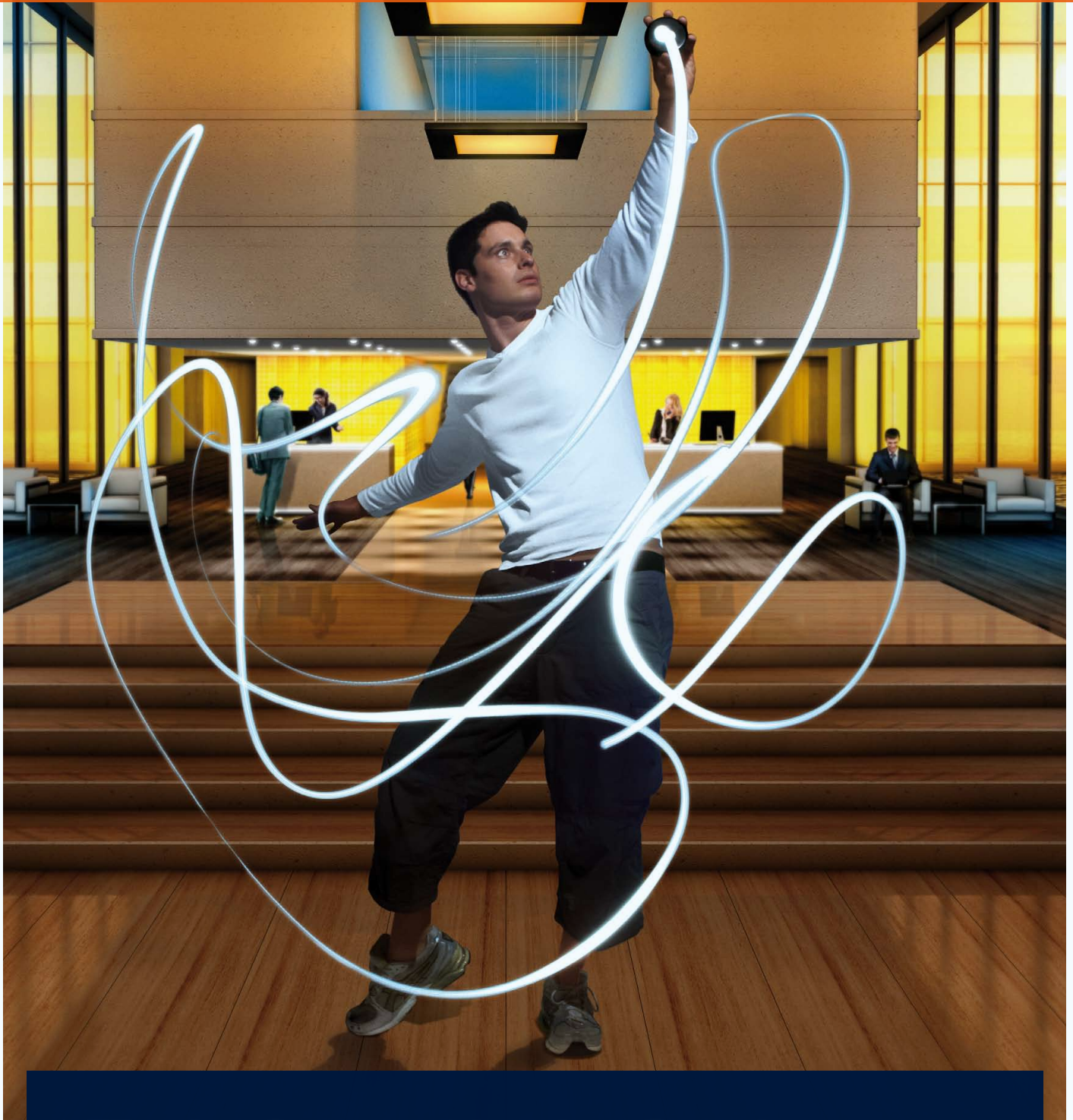

LEDs for General Lighting Solutions

OSRAM Opto Semiconductors empowers lighting solutions for today and tomorrow

OSRAM
Opto Semiconductors

Ideal for designs with power requirements of between 40 W and 150 W, the NCL30001 is designed to operate in continuous conduction mode (CCM) and can be configured as either a constant current or fixed output voltage driver. With an adjustable operating frequency of 20 kHz to 250 kHz and a multi-function latch-off pin able to implement an overtemperature shutdown circuit, the SOIC-16 packaged controller offers circuit designers a high degree of flexibility.

Features:

- Voltage feed-forward improves loop response
- Frequency jittering reduces EMI signature
- Proprietary soft-skip at light loads reduces acoustic noise
- Brown out detector
- Internal 160 ms fault timer
- Independent latch-off input facilitates implementation of overvoltage and over-temperature fault detectors
- Average current mode control (ACMC), fixed frequency operation
- High accuracy multiplier reduces input line harmonics
- Adjustable operating frequency from 20 kHz to 250 kHz
- These Devices are Pb-Free and are RoHS compliant

Typical Applications:

- LED street lights
- Low bay LED lighting
- High power LED drivers
- Architectural LED lighting

Further features of the NCL30001 controller's specification include a high voltage start-up circuit. An isolated single stage power factor corrected LED driver evaluation board is available for this device that is intended for applications ranging from 40 W – 100 W that require a direct constant current output. The current is adjustable from 0.7 A to 1.5 A. to support a wider range of high power high brightness LEDs.

"With growth in the popularity and the rapidly increasing number of LED-based lighting designs on the market, the need for highly efficient, cost effective, integrated system management devices is greater than ever," said Christophe Warin, AC-DC Business Unit Manager at ON Semiconductor. "The NCL30001 meets these requirements in full, and provides engineers with a flexible single-stage topology LED driver ideal for use in their new LED lighting products. This device is a strong example of the targeted lighting solutions ON Semiconductor is developing to meet our customers' needs." ■

POWER INTEGRATIONS New LED Driver ICs for TRIAC Dimmable Solutions

LinkSwitch-PH dramatically simplifies implementation of LED drivers requiring power factors greater than 0.9, TRIAC dimming, and high efficiency, while LinkSwitch-PL will enable very small and low cost TRIAC dimmable, single-stage, power factor corrected, constant current drivers.

LinkSwitch-PH:

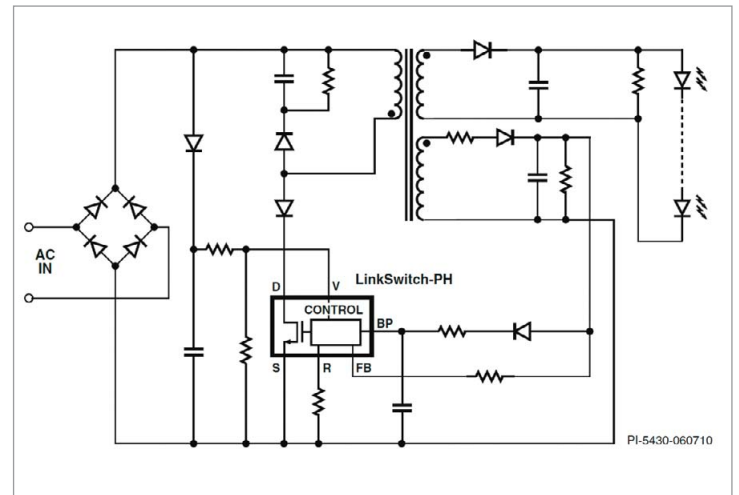

Typical application schematic with LinkSwitch-PH.

LinkSwitch-PH, a highly integrated controller, introduces a new control technique that provides very high power factor and accurate output current control, and eliminates passive circuitry required for power factor correction, optocoupler and secondary current control circuitry.

LinkSwitch-PL:

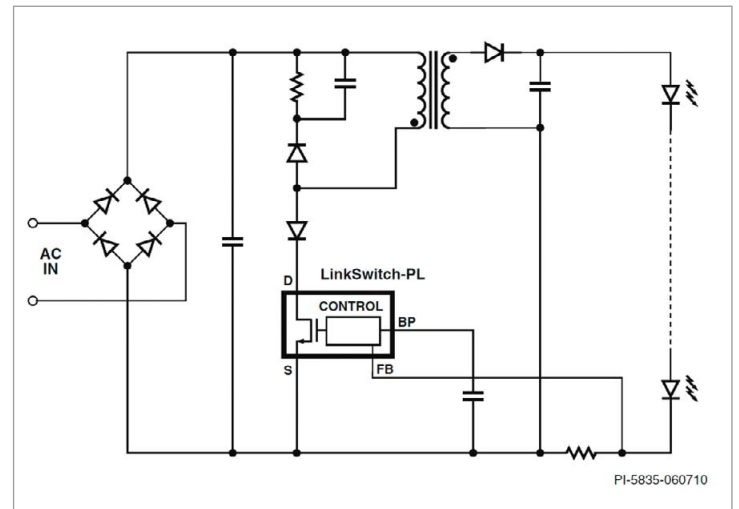

Basic application schematic with LinkSwitch-PL.

Designed for compact LED replacement lamps, LinkSwitch-PL enables very small and low cost TRIAC dimmable, single-stage, power factor corrected, constant current drivers for solid state lighting. LinkSwitch-PL is optimized for direct LED current sensing, operates over a wide input voltage range and delivers output power up to 16 W. Its innovative control algorithm provides flicker-free TRIAC dimming with minimal external components.

Each device incorporates a 725 V rated power MOSFET, a novel discontinuous mode variable frequency/variable on-time controller, frequency jittering, cycle-by-cycle current limit and hysteretic thermal shutdown in a monolithic IC. ■

Diodes Incorporated: LED Driver Increases Reliability of HB LED Systems

Diodes Incorporated, a leading global manufacturer and supplier of high-quality application specific standard products within the broad discrete and analog semiconductor markets, announces a multi-topology LED driver IC designed to increase the reliability of high brightness lamps in automotive, industrial, and commercial lighting systems. The ZXLD1370 LED driver controller operates in buck, boost, and buck-boost modes. It combines patent pending control loops and high-side current sensing to ensure accurate current control of LED strings.

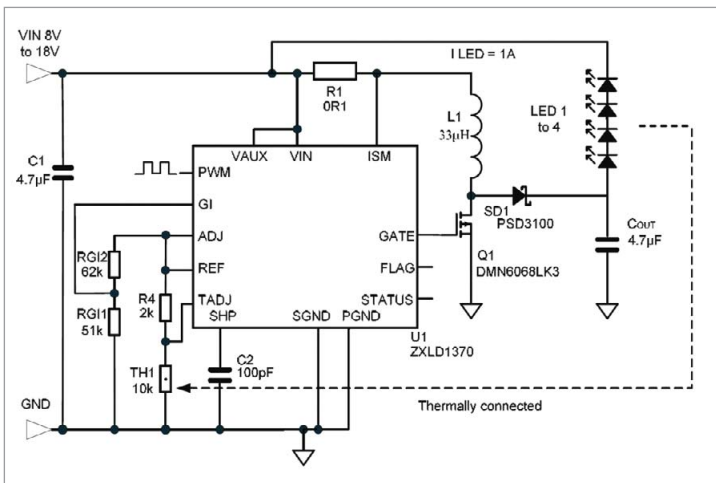

Buck-boost schematic with ZXLD1370, utilizing thermistor and Tadj.

Main Features:

- 0.5% typical output current accuracy
- 6 to 60V operating voltage range
- LED driver supports Buck, Boost and Buck-boost configurations
- Wide dynamic range dimming
 - 20:1 DC dimming
 - 1000:1 dimming range at 500Hz
- Up to 1MHz switching
- High temperature control of LED current using TADJ

With an extended 6V to 60V operating input voltage range and a typical 1% output current tolerance in all topologies, the driver is capable of delivering the high current levels and tight inter-lamp luminance-matching required by high brightness LED systems. LED reliability and longevity is improved by active LED thermal management achieved via a dedicated external thermistor input, and by fault diagnosis outputs that report the status of LED driver and load.

The ZXLD1370 LED driver controller, used with an external MOSFET, provides a single driver solution capable of supporting a very wide range of LED configurations and current requirements. It supports high accuracy dimming through DC dimming and PWM dimming options. With a dedicated PWM input, the driver offers a 1000:1 dynamic dimming range at 1 kHz. This allows for high accuracy control of color mixing and excellent resolution at low brightness levels.

The device's 1 MHz switching frequency capability with 100 kHz low frequency clamp also means a reduction in the size of the external inductor and simpler design of input EMI filters should they be required.

The ZXLD1370 uses two pins for fault diagnosis. A flag output highlights a fault, while the multi-level status pin gives further information on the exact fault. ■

Retronic Announces Highly Efficient Off-line LED Drivers

Retronic introduces 2 off-line LED drivers with an output power of up to 50W and up to 120W respectively. Target applications are LED street lighting as well as LED lighting in industrial and office buildings.

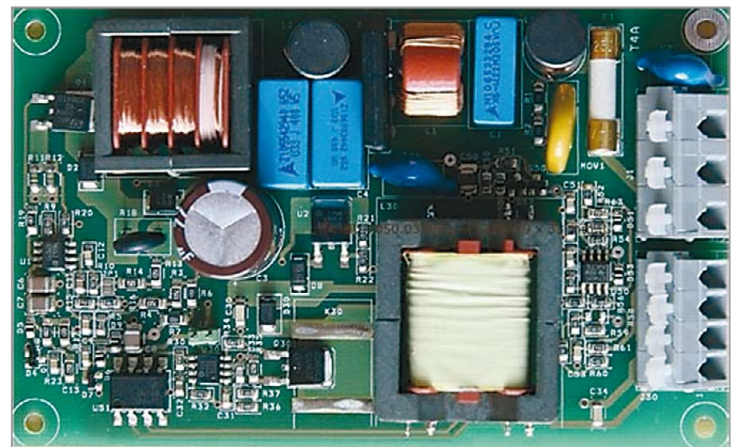

Retronic's new off-line LED drivers are offered with an output power of up to 50W and up to 120W respectively.

These drivers are designed and manufactured in Europe to drive today's most popular 1 W LEDs off the mains grid at a constant current of 350mA meeting all relevant standards like EN55015/CSPR15 or EN61000-3-2. With a surge protection of up to 4kV they are robust enough for harsh industrial environments.

Special attention has been paid to the efficiency and the lifetime of the circuitry by selecting high grade electronic devices. The efficiency is above 90% and with 60,000 hours lifetime the drivers match the expected lifetime of today's LEDs.

The 120W driver offers 3-channels with up to 50W and a total output of up to 120W. Each channel is independently dimmable with a PWM signal, making the driver also well suited for RGB applications. Depending on the forward voltage of the LEDs each channel can drive up to approximately 60 LEDs in red, yellow or amber and approximately 42 LEDs in green, blue or white.

The 50W driver with 1 channel is targeted for LED lighting buildings and has been equipped with the very common 1-10V interface for dimming the LEDs. A version in plastic housing for mounting in suspended ceilings is available.

To achieve the high efficiency the drivers are without galvanic isolation and should be installed inside the lamp and outside the reach of users. ■

MSC and Cypress: Intelligent LED Lighting Solution

MSC Vertriebs GmbH presents Cypress's newly announced powerline communication solution and AC-DC digital power controllers for LED lighting, as well as the PowerPSoC® family of integrated embedded power controllers.

The new AC-DC controllers offer a cost-effective solution for both non-dimmable and dimmable LED lighting, delivering high efficiency while meeting EnergyStar requirements. They provide automatic dimmer detection; they operate with the majority of the existing installed base of wall dimmers, providing dimming down to 2%.

The AC-DC controllers complement the PowerPSoC family of embedded power controllers, the industry's first single-chip solution for both controlling and driving high-power LEDs.



The powerline communication solution and AC-DC digital power controllers for LED lighting.

Both, the AC-DC family and the PowerPSoC family cover a wide range of LED applications, from LED retrofit bulbs to high-end LED luminaires that require a variety of functions such as communications, diagnostics, color-changing, etc. ■

Zenaro Announces a New LED Power Supply Series

The new company alliance, Zenaro Lighting Alliance adds a new line of electronic power supplies specially designed for LED indoor/outdoor lighting applications to its already broad offering of LED lighting fixtures.

An electronic power supply is a critical component when designing any LED lighting fixture. Zenaro's power supply series provides LED indoor/outdoor lighting engineers and designers with four different types of power consumptions: 54W, 66W, 102W and 132W. The entire series has passed ENEC certification and is guaranteed over 5 years / 80,000 hours. The efficiency performance of Zenaro's electronic power supplies is greater than 92%, saving more energy and reducing carbon dioxide emissions.

With different dimming control options, Zenaro gives users variety while using or designing different LED indoor/outdoor lights. The unit will support nighttime saving: switchable second line in the power line. Besides that, there is an analogue dimming function that will allow the user to linear dim the light output in order to save both energy and money on their power bill. Several US versions including UL approval will also be available by Q3/2010.

Key features are as follows:

- Input Voltage/Frequency: 230VAC / 50Hz
- Mechanical Dimensions: 166 x 76 x 51 mm
- Maximum Weight: 0.600 kg
- Input Connector Type: Amphenol C016 Series
- Output Connector Type: Binder 713 Series
- Dimming Connector: 8-03PFFS-SH7002
- Discrete Dimming: Pre-adjusted @ 40% (factory programmable)
- Analogue Dimming: Via 1 – 10VDC Interface
- Mechanical Interface/Mounting Type: 56 x 158 mm
- Additional Comments: Dimming with 1 – 10VDC
- IP65

The Zenaro Lighting Alliance provides street, interior, office and consumer lighting solutions that combine the advantages of LED technology with state-of-the-art and innovative design concepts. The products, all of them developed in their respective regions, will be designed to consider their regional distinctiveness. However, if needed, all products will also be available for use in other regions. ■

Microsemi: SSL Driver Module for LED Light Fixtures

Microsemi Corporation announced the first product in a planned family of solutions designed to provide optimized power conversion and light management for solid state lighting fixtures, enabling the energy and lifetime cost savings promise of LED-based illumination.

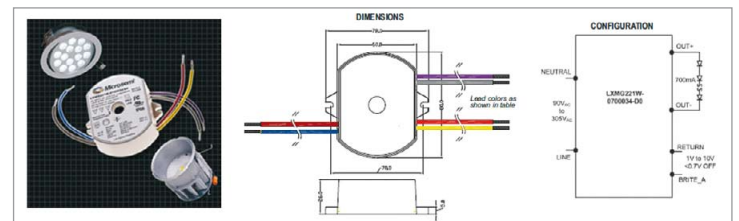

The LXMG221W-0700034-D0 module and its application schematic.

Key Features:

- Universal input voltage (90-305VAC) and frequency (50 or 60 Hz)
- High Active Power Factor (PF > 0.9) and low Total Harmonic Distortion (THD < 20%)
- Constant current single string output of 700mA
- Wide 14-48VDC output for LED loads of up to 34watts
- Peak efficiency at 90%
- Dimmable to 10% via 0-10V dimming controls and potentiometers
- Class 2 isolated power supply
- FCC Title 47, part 15 Class B compliant at all input voltages

Designated the LXMG221W-0700034-D0, the new Microsemi power supply module supports 5 to 16 LEDs and will be joined by a comprehensive portfolio of solid state lighting products in the coming months. Its universal input voltage range of 90 to 305V(AC) enables operation in 100V(AC), 120V(AC), 220-240V(AC) and 277V(AC), 50Hz and 60Hz systems. The new Microsemi module provides 90% power conversion peak efficiency while delivering non-flickering dimming down to 10%.

The LXMG221W-0700034-D0 module can be easily integrated into dimming and non-dimming fixtures and meets requirements for both commercial and residential applications, including its pending CE and UL1310 certification. Its compact, IP66-rated plastic package protects the power supply from dust and temporary water exposure and offers a thru-hole for more secure mounting.

"The SSL market is a key new market for Microsemi, and we are well positioned to leverage our leadership in power conversion and light management as well as our analog mixed signal design capabilities to develop optimized products for the next-generation of smart lighting fixtures," said Irene Signorino, director of marketing, Lighting and Automotive Products with Microsemi. "Thanks to our unique and robust supply chain, we can offer our first product family of complete AC/DC modules, the LXMG221W, directly to LED lighting manufacturers. This will help shorten the customers' time to market and simplify the communication of their new LED-driven design challenges through a still CFL-centered supply chain."

The AC/DC power supply and driver is a key component of the LED fixture. LEDs have unique electrical, photometric and thermal behavior that the driver has to take into consideration to achieve the promised long life and high energy efficiency. Moreover, end users will soon discover how much more they can expect from a lighting fixture. Novel features that can be optimally offered by LED lighting. This will only be possible with smart and optimized LED drivers.

The new power module was demonstrated May 25-27 at the 2010 International Symposium of the Society for Information Display in Seattle, which added a focus for the first time on LED applications in general illumination. ■

Labsphere's LMS-3M Three Meter Lamp Measurement Integrating Sphere

With lighting technology advancing to include larger and more complex devices, Labsphere has introduced the LMS-3M three meter integrating sphere for complete optical characterization of these larger lamps and luminaries. The sphere complies with IESNA LM-79 and LM-80 standards to deliver accurate and reproducible measurements of any lamp, up to 2m linear lamps and 30cm luminaries.

The three meter lamp measurement integrating sphere accommodates light sources positioned base up, base down, or longitudinally, to easily and efficiently measure virtually any lamp type, including fluorescents up to 2m in length. The design also allows for forward and partial flux measurements of test sources that are board mounted or heat-sinked.



Universal Portable Light Meter

Strategies in Light Europe

The Leading Events for the Global LED and Lighting Industry

Visit us at Strategies in Light
28-29 sept 2010 at stand 28

Jaz
does
it all!!

Lumen

Lux

PAR

CRI

CIE

CCT



The larger sphere better integrates light for more reliable testing of a device's photometric and colourimetric performance with measurements of Total Spectral Flux, Luminous Flux, Correlated Colour Temperature (CCT), Colour Rendering Index (CRI), and Chromaticity. Measurement data relies only on the test device's true power, not on the size, shape, or spectral distribution.



Labsphere's LMS-3M Three Meter Lamp Measurement Sphere.

The near-Lambertian properties of the sphere's Spectrafect® interior coating provide a uniform dispersion of light that integrates and reduces hotspots better than other available sphere coatings materials. Spectrafect exhibits reflectance values of 98% and is spectrally flat through the visible spectrum for higher optical efficiency on low lumen lamps.

The LMS-3M is designed to measure a variety of lamps and luminaires on the same system with little adjustment. The standard sphere geometry accommodates 4pi measurement, and with optional aperture reducers, can easily be configured for 2pi measurement.

Baffled intake and output ports and an ambient air temperature controller maintain and monitor the temperature inside the measurement environment, complying with Energy Star requirements. The new sphere size fully integrates with all Labsphere photometric and spectroradiometric systems and software so current system users may upgrade easily. ■

AGC Releases Glass-Ceramics Substrate for HP LED Lighting

AGC (Asahi Glass Co., Ltd.) will start sales of a new glass-ceramics substrate that enables high-brightness and high-durability for LED lighting. This new glass-ceramics substrate will expand LED applications in the lighting and illumination sector, including 3D televisions and automotive lighting, in which high-power output is increasingly in demand.

Starting the volume production at a newly-built factory in Taiwan, AGC aims to achieve a market share of 20% or over in the glass-ceramics substrate market for high-output LED lighting, which is expected to grow into a 100-billion-yen market by 2020.

So far, LED applications have been limited primarily to products with extremely small power output, such as liquid crystal display televisions and home interior lighting. In the future, however, the demand trend is expected to shift toward high-output LED applications that require high-brightness, such as 3D televisions, automotive headlights and other automotive lighting, and outdoor lighting and illumination.

In addition to high-brightness, high-durability is also a prerequisite for high-output LED applications as heat generation becomes greater as the power output increases. Conventional resin substrates are susceptible to high temperature and are not considered suitable for high-output LEDs. In contrast, alumina substrates are heat-resistant, but the reflectivity deteriorates over time as the silver reflective film, which is used for enhancing high-brightness, becomes sulfurated over a prolonged period. In addition, due to the poor moldability, alumina substrates are considered to have only limited usage.

AGC's new substrate that is created through the integration of their glass technology and ceramics technology enables both high-brightness and high-durability for high-output LEDs, and has excellent moldability into compact shapes.

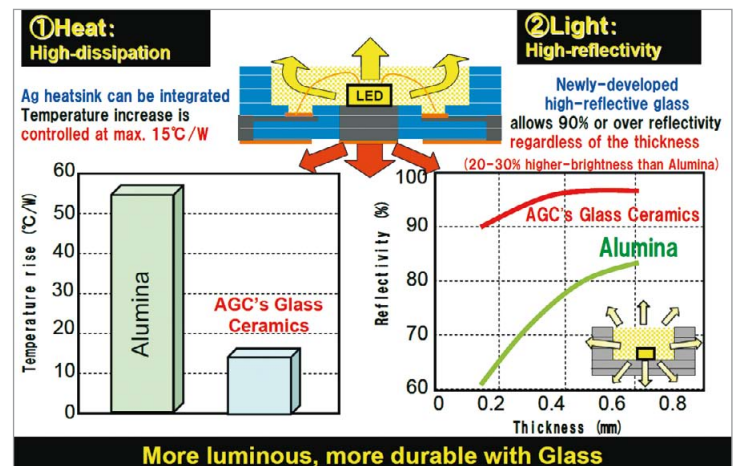

Features of AGC's glass-ceramics substrates.

The product features are as follows:

1. High-brightness: High-reflectivity enhanced the brightness by 20%-30% as compared to alumina substrates (reflectivity varies depending upon the thickness of the substrate).
2. High-durability: Excellent heat dissipation design allows higher heat dissipation rate than alumina substrates. Also, the reflectivity does not deteriorate over a prolonged period.
3. Excellent moldability: Excellent moldability enables a compact and complex cavity structure.

Leveraging our strengths, AGC is determined to move into the field of LED lighting and various other next-generation lighting materials, and introduce new products to the market at an accelerated pace. ■



innovative control system for LED lights



info@signcomplex.com www.signcomplex.com Tell:+86 755 2760 8650 Fax:+86 755 2760 8651



24th International Trade Fair
New Munich Trade Fair Centre
09-12 November 2010

Register online and enjoy the benefits:
www.electronica.de/en/tickets

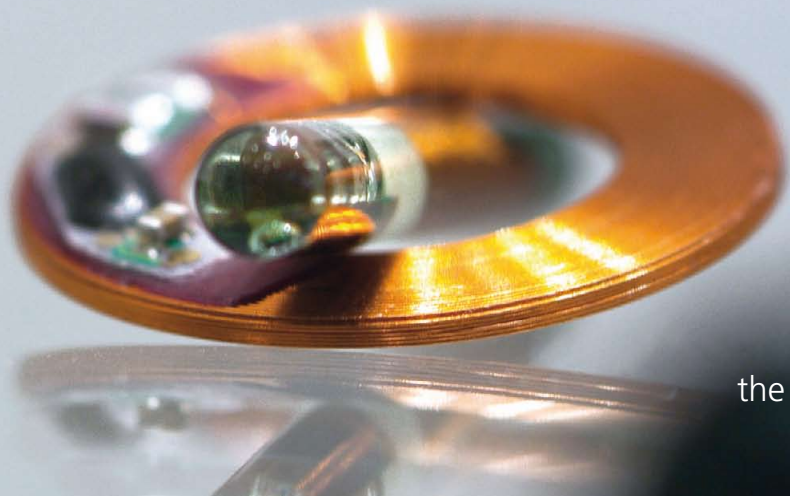

erolqxə

the possibilities of tomorrow.

Automotive | e-Mobility | Displays / e-Signage | Embedded systems / software | Medical / MEMS | Photovoltaics

Time for electronics. Time for the future.

Key topics, trends and technologies. The latest components, systems and applications. Visit **electronica 2010**, the international trade fair that will show you today what is important tomorrow and generate momentum for real growth.

Parallel event: **hybridica**. Trade fair for hybrid-component production. www.hybridica.de
get the whole picture



www.electronica.de/en

Elation: “Light Shaping Filters” Give Any LED Fixture a Wider Beam Angle

LED technology offers lighting users many advantages, such as energy efficiency, low heat, low maintenance and the ability to perform RGB color-mixing. But many LED fixtures also share something else in common - a narrow beam angle or uneven field of light, which can restrict them from being used for certain applications such as stage or wall washing.

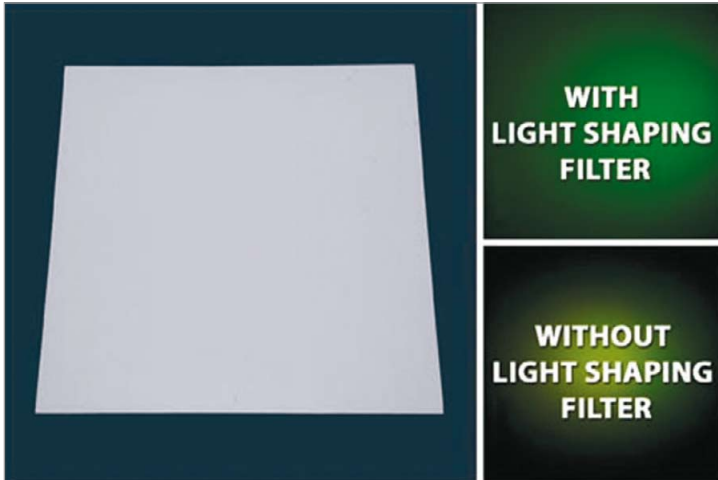

LSF Series Light Shaping Filters smooth out or widen the beam angle of any LED fixture.

Now you can instantly smooth out or widen the beam angle of any LED fixture - and broaden your design possibilities - with new LSF Series Light Shaping Filters from Elation Professional. Easy-to-use, Elation Light Shaping Filters attach to a gel frame or the inside of an LED's casing in minutes - to add 10°, 20°, 30° or a linear beam shape effect to its beam angle that's ideal for stage or wall grazing, without requiring complicated or permanent alterations to the fixture.

Elation Light Shaping Filters offer a great way for lighting designers to get more versatility from their LED fixtures for a relatively small investment, said Eric Loader, director of sales for Elation Professional. “Customers have been asking for wider diffused LED lighting fixtures without losing a lot of output, and our new Lighting Shaping Filters provide an easy, cost-efficient way to attain this,” said Loader. “Using one of these filters, you can widen the beam of a narrow beam angle LED par like our Opti Tri 30 and convert it into a fixture suitable for a stage or wall wash.”

Unlike many beam-widening diffusion filter products available in the past, which significantly reduced light output, Elation Light Shaping Filters have been designed to preserve as much power as possible while dispersing light. They provide up to 92% light transmission, while standard diffusion filters typically transmit only 60% of the light, according to Loader. “Our LSF filters are unique in that they give you a wider beam angle without sacrificing much output, and they also smooth out the beam of any LED fixture that does not have a perfect field of light,” he said.

Elation Light Shaping Filters are available in four different beam angles: 10° LSF10-24), 20° (LSF20-22), 30° (LSF30-24) and 60°x1° (LSF601-24). With the first three versions, the beam angle is widened both vertically and horizontally - say 10° in both directions. The 60°x1° version broadens the angle 60° horizontally and only 1° vertically, making it great for long, flat wall washes. As an example, Elation put a 60°x1° filter on two LED par cans, spread them out approximately 4' on center and covered a 10' area of wall with the two fixtures, creating an ideal setup for up-lighting applications.

Extremely versatile, Light Shaping Filters can be used with LED fixtures made by any manufacturer, not just those from Elation. The filters come in large sheets, allowing users to cut them in the sizes needed. Each sheet measures 24”x 24” (except the 20° version which is 24”x 22”). If outfitting a 6” LED par can, for example, 16 filters could be cut from a 24”x 24” sheet, making the cost per fixture very affordable. ■

LORD Corporation Develops Low Modulus Thermally Conductive Adhesive

LORD Corporation – a leading supplier of thermal management materials, adhesives, coatings and encapsulants to the electronics, LED and solar industries – has announced the availability of a new low modulus, high thermal conductivity adhesive.

Created in response to a market need for a more flexible, high thermal conductivity adhesive, MT-815 can be used in a variety of applications including as a thermal adhesive for large die, in die attach applications, or as a solder replacement. The first in a series of new low modulus, thermal conductivity adhesives from LORD Corporation, MT-815 has a modulus of <1 GPa, allowing it to be more flexible and therefore less likely to crack or delaminate under the stresses of temperature cycles.

MT-815 was also formulated to achieve thermal conductivity of >10 W/m-K, creating a new class of flexible adhesives with high thermal conductivity.

According to Sara Paisner, Staff Scientist for Thermal Management Technology at LORD Corporation, MT-815 builds on a long tradition of innovation in thermal management materials, including Gelease™ thermal conductive gels, as well as high performance thermal conductivity adhesives like MT-315 and TC-501 no pump-out grease.

“Most thermal adhesives are either flexible with low thermal conductivity (i.e. silicones) or highly rigid with higher adhesion (epoxies). As a result, their uses are limited in microelectronic packages,” said Paisner. “However, this thermal conductive adhesive combines the advantages of high adhesion and thermal conductivity with the need for lower modulus to accommodate the large stresses experienced by electronic packages.”

“LORD is responding to interest from customers who require a low modulus, thermal adhesive to accommodate higher stresses from larger die sizes but cannot sacrifice thermal conductivity. We look forward to working with our customer base to continue our history of innovation in thermal management materials with the introduction of MT-815” said Adam Conklin, LORD Global Market Manager – Electronic Materials. ■

Bodo's Power Systems®

Your best choice to communicate!
Free subscription on www.bodospower.com

One World
One Magazine
On Time, Always



Partner with these events:



Characterization

LED Luminaire Lifetime: Recommendations for Testing and Reporting

> DOE Lifetime and Reliability Working Group

Introduction – Understanding SSL Luminaire Lifetime

Surprisingly to many, the true reliability and lifetime of the light-emitting diode (LED) lighting systems is currently unknown. Even worse, lumen maintenance values of LED devices are widely used as a proxy for the lifetime of an LED lighting system, which is misleading since light degradation or lumen maintenance is but one component of the reliability of a luminaire. For many manufacturers this approach cannot simply be ascribed to overly ambitious marketing efforts, but rather to dependence on anecdotal numbers in the absence of real data. In addition, we can impute simple ignorance in taking specifications at face value which may or may not live up to claims.

It isn't just about the LED. Good LEDs can be incorporated into poorly engineered products and turn the Methuselah of lighting into the exponent of "live fast, die young." The promise of LED lifetime is often presented in terms of hours and years but with little background data to support anything beyond vacuous promises. The statement of 100,000 hours of LED luminaire lifetime has given way to the realization that there is little consistency, very little published data, and few hard facts around so-called luminaire lifetime numbers. The situation is better at the LED package level, where reputable manufacturers have thousands of hours of data under varying conditions. But this is not enough.

To manufacturers and specifiers in the solid-state lighting (SSL) community, the dawning realization is that we need to work together towards understanding the issues surrounding true lifetime and reliability. We need to begin by cataloguing such failures and developing good models for underlying failure mechanisms. This process of understanding and explanation is very common in technological progress. Steam engines existed long before deep understanding of thermodynamic processes. With LEDs, we have a substantial head-start on the underlying physics and many years of experience in both lighting and semiconductors as well as reliability of related products.

There is no reason not to begin this journey and every reason to start. We will figure this out, find reliability methods and metrics, and learn the underlying root causes of failure. But without data, experiments and models, it is all conjecture. We need a program to drive to reliability metrics.

Types of failures encountered

An LED luminaire is in many ways more complex than a traditional lighting fixture. It is an electromechanical system that includes, in addition to the essential light-emitting source, provisions for heat transfer, electrical control, optical conditioning, mechanical support, and protection, as well as aesthetic design elements. Because the LEDs themselves are expected to have a long

life, all of these other components, adhesives, and other materials must have an equally long life. To the extent that they do not, they will limit the system lifetime.

While LEDs do not radiate heat, with current products half or more of the input energy may be converted to heat that must be conducted away from the diodes. This situation requires a reliable, heat conducting assembly, be it mechanical or adhesive, in addition to a heat sink component or means for further conduction. For proper operation, the power supply and electronics must provide a well-controlled DC drive current and possibly other control features, and must not fail for the life of the product.

Any optical components must be able to withstand years of exposure to intense light and possibly heat without yellowing, cracking, or other significant degradation. Reflecting materials need to stay in place and maintain their optical efficiencies.

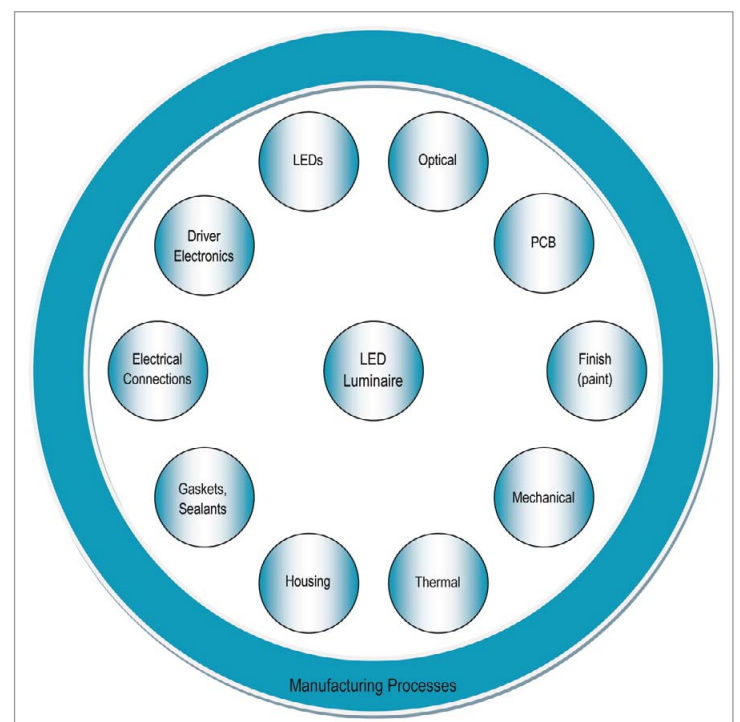

Figure 1: Total system or luminaire reliability is the product of all of the individual reliability considerations as follows: $R_{Luminaire} = R_{LEDs} * R_{Optical} * R_{PCB} * R_{Finish} * R_{Mechanical} * R_{Thermal} * R_{Housing} * R_{Gaskets} * R_{Sealants} * R_{Electrical} * R_{Driver} * R_{Manufacturing}$.

Even if the design itself has addressed all of these issues, questions of proper manufacturing remain. Was the epoxy properly mixed? Was an essential heat-transmitting paste omitted? Were the wire bonds properly made? Any of the failure mechanisms inherent in electronic assemblies, and many others, may apply to an LED luminaire. Figure 1, above, is an attempt to visualize this larger scope of SSL reliability.

For the best lifetime in a well-designed and properly assembled luminaire, the principal failure mechanism should be lumen depreciation - a gradual reduction of light output from the packaged LED over time. But other mechanisms could come into play. One LED vendor has reported that the principal causes for customer complaints involve either the use of chemicals in the luminaire that are incompatible with the LED or the driver overstressing the LED. These are design issues, but equally important are early failures of

other components or subsystems or manufacturing defects. These additional failure mechanisms will always persist to some degree and will usually lead to catastrophic failure, but they may sometimes simply accelerate lumen depreciation. An important message of this guide is that these mechanisms must be accounted for in describing product life.

Lumen Lifetime

Recommended definition of lifetime

For conventional technologies, the "rated average lamp life" is the point at which half the lamps cease to emit light. All sources lose light output over time, but generally not more than 15–20 percent over the rated lamp life as defined by complete, lights-out failure. A well-designed LED package, however, would typically have a very long-rated life, as conventionally defined, but, because it is so long, would also have more lumen depreciation over that life than conventional technologies. Accordingly, we need a new approach.

Whatever the stated lifetime of any lighting product, it is a statistical measure of the performance of a given design. For an individual LED package, lifetime has typically been considered to be the hours of operation at which the light output has fallen to 70 percent of its original value ("L70"). Lifetime is typically reported as the median time to failure of a population of diodes under normal operating conditions, called "B50." In other words, after this period of time, half of the units will fail due to low light output. While B50 represents a time interval, L70 is the lumen performance level defining a low-light failure. For some applications the median time, B50, may be unacceptable. Designers in these cases might prefer to know when 10 percent of the product has fallen below the defined level. Depending on the target market, therefore, manufacturers may choose to report B50, B10, or some other time for a particular product. L70 is widely accepted in LED lighting, but for non-demanding cases, L50 may be acceptable. In other words, lumen depreciation cannot be adequately described by a single metric.

This kind of lifetime definition, lumen depreciation, can be and has commonly been extended to a luminaire, but that is not enough. We must consider other failure mechanisms as well. Reporting failure only in terms of low light output, regardless of cause (i.e., including catastrophic failures) does not give the designer enough information. If the lifetime is stated to be 20,000 hours, does that mean half the lights are at 70 percent of their initial output, or does it mean half the lights are nearly at full output and the others are completely out, or something in between?

To address this ambiguity, two numbers are needed: the lumen maintenance lifetime, e.g., B50 or B10, and the conventional electric failure lifetime, e.g., F10 or F50, when 10 percent or 50 percent of the luminaires fail in a conventional sense. Both times - B and F - must be measured on the complete luminaire because of the interactions among the components.

These B and F numbers can describe four types of luminaire failure:

1. All LEDs light up, but at a reduced light level (defined by time to Bxx).
2. There is a single catastrophic LED failure, but other LEDs are still functional, perhaps running at a reduced light level (defined by time to Bxx).
3. There are multiple catastrophic LED failures, but other LEDs are still functional, perhaps running at a reduced light level (defined by time to Bxx).
4. No LEDs light up, due to system failure other than the LED (defined by time to Fyy).

If a lifetime claim is made, DOE recommends using the L70 reference value for light output and reporting two values as follows:

1. Bxx – the lumen maintenance lifetime at which for xx% (e.g., 50%) of the product light output falls below 70% of the nominal initial value.
2. Fyy – the electrical failure time for which yy% (e.g., 10%) of the population has experienced conventional lights-out failure.

Ideally, the numbers above should reflect a sufficient set of measurements that can be reported with a reasonable degree of confidence. The reported lifetime should have at least sufficient measurement accuracy and sample size to provide a 50 percent confidence level. While this may be a practical limit in the near term, 90 percent or higher is more desirable. However, the working group recognizes that these measurements are expensive and time-consuming, and not all manufacturers may have the ability to comply when the product is first introduced. However, if the recommended minimum confidence levels are not achieved, manufacturers still have the option not to make a lifetime claim in the technical sense, but to warrant performance for a specific period of time instead.

The choice of xx and yy is up to the manufacturer and may vary by intended customer base or manufacturer; however, it should be explicitly stated. The examples of B50/F10 above might not suit high-performance applications, for example, but may be satisfactory to the consumer. This definition of lifetime does not include color shift. It is strictly in terms of light output, although that could be because of either gradual lumen depreciation or catastrophic failure or accelerated degradation from many causes. For many users, excessive color shift might also be deemed a failure, so this guide recommends that color shift may optionally be a separately stated specification for the stated lumen life of the product. Color is more fully discussed later on in this article.

The means of determining lifetime are not fully standardized at this time. Additional observations concerning the determination of lifetime and methods of projecting lifetime from shorter-term measurements are discussed below.

Demonstrating lifetime

This section addresses some of the necessary steps to demonstrate the product's lumen maintenance life claim, separately considering a new platform, and then how to deal with variations in that platform. While some examples are shown, they are not intended to specify a standard procedure. Responsibility for specific standards lies with standards organizations and is beyond the scope of this guide.

New Platform Lumen Maintenance

For a new platform it is the manufacturer's responsibility to demonstrate life performance compliance by testing luminous flux, in accordance with LM-79, in a sufficient sample of product for a sufficient amount of time to have confidence in the lifetime figures. An important question concerns the required period of time. A TM21 committee of the Illuminating Engineering Society of North America (IES) is exploring the issue of extrapolating L70 from limited measurements, such as recording changes every 1,000 hours up to 6,000 hours. Several studies have shown how difficult this extrapolation can be. The eventual result of these continuing studies will most likely indicate a maximum degradation of light output over a specific period that is required to demonstrate a given lifetime. For example, for a claimed life of 36,000 hours, the lumen maintenance might be required to be 91 percent or better after 6,000 hours. As of this writing, the results of this work have not been published, but when available, they may be used to extrapolate to the L70 value.

To show compliance, a test report might include the following:

- Graphical presentation (with error bars) of lumen output versus time, color shift versus time, and input power versus time
- Summary table showing in lumen maintenance (percent) change in input power (percent), and change in color after 6,000 hours of testing
- LM-79 reports at T = 0 and T = 6,000 hours
- Description and details of the product under test and test setup
- Sample size and/or confidence interval

Although extrapolated LM-80 data for packaged LEDs has been used as a proxy for luminaire lifetime (and is an ENERGY STAR requirement), it may not be very accurate for the many reasons cited in this guide. The working group, therefore, recommends LM-79 testing of the complete luminaire to determine lumen output over time.

Product Variation of New Platform

Recognizing possible platform variations to extend the product line for other applications (product groups) or material or design changes, additional measurements may be needed to ensure the platform is still qualified. Consideration may be given to minimize the number of test hours to demonstrate the long-term life performance as described above. In this regard, it is reasonable to consider the different types of change (or model variations) and their likely impacts on lifetime. Ultimately, this is the customer's choice, but it is recommended that manufacturers develop and document specific rules for change control to maintain the integrity of their products.

For example, changes in the following areas may be deemed to require significant retesting:

- Housing/chassis
- Thermal management/heat sink
- Change of assembly method or materials
- Light source (includes operating current, Vf, and LED suppliers)
- Power supply

Other changes, such as in finish or out of the optical path, may require less requalification. Analytical data may often be used in part to demonstrate that the change has not influenced the lumen maintenance performance of the luminaire. But typically a small number of luminaires may need to be retested for some, perhaps shorter, period of time. If the manufacturer cannot demonstrate via analytical data or limited testing that life performance is not diminished, then the luminaire should be treated as a new platform and subject to full qualification requirements.

The relevant recommendations from this guide are that manufacturers develop and document their own change control process, and that they are responsible for providing sufficient justification to their customers so that any change will be accepted as having no material, deleterious effect on product lifetime.

Color Shifts**Relation to Lifetime**

As noted above, "lifetime" refers only to lumen output of the fixture, but it includes failures due not only to systematic degradation as measured by LM-80, but also to any other mechanisms of overall lumen degradation, including changes or failures in components other than LED. Lifetime does

not include color shift, per se, even though for some applications excessive color shift might be considered a failure by the user. The decision to prioritize lumen output reflects the fact that lumen maintenance is related to life safety issues in various applications while color stability is related to aesthetic concerns. However, this reality could, nevertheless, result in customer dissatisfaction, so we discuss color shift in this section of the guide.

LM-80 recognizes that color is important and, further, requires that the test report include "chromaticity shift reported over the measurement time." It does not, however, provide any recommendation to project the shift to the end of life, nor does it address color shifts that may be attributable to the luminaire design or manufacturing. Regarding lumen maintenance, experiments suggest that, assuring that the temperature of the LED does not exceed certain limits and that the drive current does not change excessively, it is possible to extrapolate the LED lumen maintenance contribution to lumen depreciation to the luminaire. This approach may not work, however, for color shift. Furthermore, full luminaire color measurements are prohibitively expensive, all but ruling out the option to predict color shift over the life of the product. A final challenge to providing useful color shift information to users is that there is no simple, consumer-friendly way to describe it. Correlated color temperature (CCT) alone is really not a precise-enough metric to describe the change in many situations.

It is clear that considerable work remains before we will be in a position to accurately specify end-of-life color shift limits for a specific luminaire design. Given this situation, and pending further work by standards organizations, we recommend that manufacturers designate products in one of three categories: "lamp replacement," "luminaire (standard grade)," or "luminaire (specification grad)," and then treat color shift differently for each segment.

1. Lamp replacements are more amenable to LM-80 color shift measurements and projections since the design is consistently repeated, and sales volumes are high. Color can be specified on the Lighting Facts label in general terms for what is assumed to be a non-critical market.
2. Standard-grade luminaires would specify a maximum warranted color shift, probably in terms of CCT for now. It would be up to the manufacturer to determine what limits should be specified and for how long a period the warranty applies, which may or may not coincide with the lumen lifetime.
3. Specification-grade luminaires are intended for more discerning customers. More sophisticated color metrics may be included in the specifications, and the maximum color shift over the stated lumen lifetime would be provided. Some professional-use lamp replacements might be included in this category as well.

All three categories require some means for the manufacturer to predict color shift over a period of time, but with greater or lesser precision depending on the classification. Additional work is needed outside the scope of this article to improve these methods.

Projection of Color Shift

LM-80 requires LED manufacturers to collect data on color shift over 6,000 hours of operation. However, there is no accepted standard way to use this data to extrapolate color shift. The IES TM21 committee is working to set standards on how to extrapolate LM-80 data for lumen depreciation but has deferred the issue of color shift.

Factors that will make color shift so difficult to extrapolate include differences in LED design, materials, manufacturing processes, optics applied to the

LED, and the temperature and time the LED operates. Many experts indicate that it will be a long while (possibly years) before there is general agreement on how to project color shift for an LED over an extended period of time.

Impact of Luminaire Design and Manufacturing Practices

Color stability, like lumen depreciation, is not exclusively determined by the performance of the LED. Examples of how luminaire design and manufacturing practices will impact color quality and color shift include:

- Different heat sink designs will mean that LEDs and the associated electronic circuits will likely see different operating conditions despite operating at similar times under similar temperature conditions.
- Different materials used in secondary optics may age differently.
- Different environmental conditions (including air quality) may cause materials in different luminaires to behave differently.
- Different luminaire designs may create non-uniform color characteristics such as halos or yellowish, bluish, or greenish hues around the edges of the beam, and these color characteristics may vary over time.
- Some manufacturing processes have tight initial selection criteria, and others loose selection criteria, and that will complicate the determination of color shift over time.
- Finally, some luminaires address color shift with active color management, including sensors and controls. However, sensors and controls may themselves shift over time and affect color.

Limitations Due To Expense

As LED lighting is a relatively new industry, we lack field data on how much color shift is likely due to the LED compared to the color shift due to the luminaire design. For this reason, as well as for the luminaire and manufacturing effects just cited, the only definitive way to determine color shift is to measure the entire system comprising the LED, the other parts of the luminaire, its operating time, and its operating environmental conditions.

Currently, however, collecting LM-80-style data at the luminaire level is prohibitively expensive for many luminaire types for several reasons:

- It can take hours to stabilize the temperature of a large luminaire.
- Luminaires are tested at steady state currents, not pulsed as with LEDs.
- Extensive space may be required for storage and test fixtures, as compared to LEDs.
- Luminaire tests using LM-79 require skilled technicians and are labor intensive.

Luminaire-level testing would also seriously delay product introduction, which adds to overall expense and limits the rate of market penetration. While such expenses may be justified in limited professional applications sensitive to color, that is the exception rather than the rule.

Describing Color Shift

Consumers have no experience with, and cannot be expected to easily relate to, scientific or engineering terms that are used to discuss color, including "chromaticity," "black body curves," "LED bins," or "Macadam ellipse." There is no standard consumer definition that can be used as an alternative, although the current Lighting Facts label describes color in terms of CCT, and qualitatively using words such as "warm" or "neutral." This may be adequate, as it is similar to descriptions now being used for conventional lighting, and recent progress with consumers learning to read food labels suggests consumers will be able to learn to look for and understand the data on the Lighting Facts label. Even so, these descriptions do not provide a simple way to describe color shift. While professionals may be able to decipher terms such as the change in color coordinates ("duv") or even the change in color temperature (" ΔK "), it will probably be some time before they would be useful for the consumer. Simpler terms reflecting a qualitative, relative color stability may be more appropriate. ■

We bring quality to light.



LED Test and Measurement

Measure all optical and electrical parameters of single LEDs, high-power LEDs and LED modules in conformity to international standards accurately and within seconds. With equipment from Instrument Systems – the world leader in LED metrology.

- Luminous intensity (candela)
- Luminous flux (lumen)
- Dominant wavelength (nm)
- Color coordinates (x, y, z)
- Spatial radiation pattern
- Thermal behavior



Instrument Systems
light measurement

Phone: +49 89 45 49 43 0 · info@instrumentsystems.com · www.instrumentsystems.com

Authors

This article shows an extract of the full report published from the DOE Lifetime and Reliability Working Group in May this year. The following people were involved in generating this report:

Jim Anderson, Philips Color Kinetics; Dennis Bradley, GE; Michael Bremser, Permlight; James Brodrick, DOE; Steve Briggs, GE Lighting; Fred Carpenter, Acuity Brands Lighting; Peter Childs, OSRAM Sylvania; Terry Clark, Finelite; Kevin Dowling, Philips Color Kinetics; Jerry Duffy, GE; Phil Elizondo, Xicato; Joseph Gallant, OSRAM Sylvania; Doug Harriott, OSRAM Sylvania; Robert Harrison, OSRAM Sylvania; Rudi Hechfellner, Philips Lumileds; Mark Hodapp, Philips Lumileds; Marc Ledbetter, Pacific Northwest National Laboratory; Eric Ladouceur, Philips Lumec; Rob McAnally, Appalachian Lighting Systems; Matthew Mrakovich, GE; Hampton Newsome, FTC; Mia Paget, Pacific Northwest National Laboratory; Ann Julie Palmteer, OSRAM Sylvania; Jim Petroski, GrafTech; Chris Primous, Permlight; Jeff Quinlan, Acuity Brands Lighting; Michael Riebling, Philips Hadco; John Rivera, D&R; Linda Sandahl, Pacific Northwest National Laboratory; Lindsay Steele, Pacific Northwest National Laboratory; Mikio Suzuki, OptoElectronix; Ralph Tuttle, Cree; David Szombatfalvy, GE; Craig Updyke, NEMA; Fred Welsh, Radcliffe Advisors; Jeremy Yon, Litecontrol.

Comparison of Test Results from Different Korean Testing Laboratories

> Dong-Hoon Lee, Seongchong Park, Seung-Nam Park, Ju-Eun Lee and Yong-Wan Kim, Korea Research Institute of Standards and Science

We report on the test object preparation of a comparison of SSL products among accredited testing laboratories in Korea. Two types of commercially available LED-based SSL lamps are circulated for measurement of total luminous flux. For selection and characterisation of the test objects, we recorded the temporal change of the luminous flux and the lamp temperature simultaneously using a thermocouple permanently attached to the lamp heat sink. The temperature coefficient of the test objects is determined from the preparation data, which is used to compensate the ambient temperature difference between the participants' laboratories. A stability of better than 1% is achieved while being circulated to seven participants for one month.

Introduction

Solid-state lighting (SSL) products based on LEDs are emerging in the market. The energy saving effect from their high luminous efficacy and the functionality from their distinguishing spectral and spatial emission characteristics are counted as the major strong points of the SSL products. The distinguishing characteristics of LEDs, on the other hand, make the accurate photometric measurement more challenging. This is of essential importance to specify and control the technical performance of the SSL products [1,2].

Total luminous flux in the unit of lumen is the key quantity to specify the energy efficiency of the SSL products. The certification program for Korean Standards (KS) of high efficiency SSL products needs to be supported by a well-established accreditation scheme of the testing laboratories in the field of SSL photometry. As the national metrology institute of Korea, KRISS coordinated a round robin test of SSL lamps among seven testing laboratories in Korea to compare their proficiency of total luminous flux in 2009. In this paper, we report on the preparation of the test lamps for this domestic comparison.

The main issue for the preparation of the test objects was how we compensate the different ambient temperature of the participants' laboratories. Our solution was to record the temperature of the lamp case with the photometric quantity in the pre-burning stage.

Lamp Selection

Two different types of white, E26-based SSL lamps are used for the comparison. The first type (bulb type) has nearly lambertian angular distribution and the second type (down-light type) has an angular distribution concentrated within ± 60 degree. All lamps are operated at 220 VAC.

We tested eight different models from four manufacturers, which are currently dominant on the Korean SSL market. After preliminary pre-burning tests, two models (one bulb type and one down-light type) were selected based on their high stability and reproducibility. Figures 1(a) and 1(b) show the photographs of the two models selected to be the test objects for the comparison with the thermocouple attached. The manufacturer's specification for total luminous flux was around 500 lm for the both types.

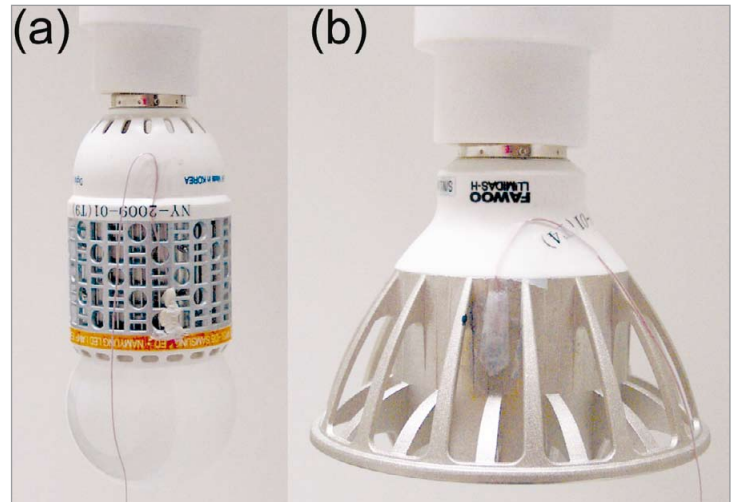

Figure 1: Photographs of the SSL products used in the total luminous flux comparison; left - bulb type lamp (a), right - down-light type lamp (b).

Pre-burning with Temperature Monitoring

On each lamp, we permanently attached a thermocouple sensor on the heat sink in order to monitor its temperature. The temperature readout from the thermocouple is calibrated against a reference platinum resistance thermometer in a liquid bath before attachment. We pre-burned each lamp in the KRISS integrating sphere photometer with a diameter of 2 m and simultaneously recorded the photometer signal and the lamp temperature as a function of time.

Figure 2 shows the measurement result of the pre-burning for a bulb type artefact. The relative values of total luminous flux are plotted together with the lamp temperature as a function of time after turning on. The figure shows that the luminous flux decreases rapidly at an early stage and starts to stabilize after 30 minutes. After 1 hour of operation, the relative change of luminous flux is smaller than $\pm 1\%$. The amount of change of total luminous flux was more than 10% before stabilization. The other test model lamps also showed similar characteristics.

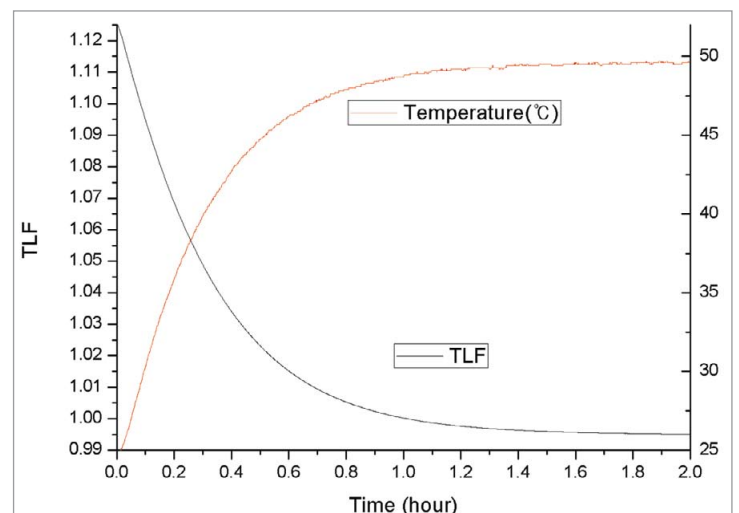

Figure 2: Plot of the relative total luminous flux (black line) and the lamp temperature (red line) as a function of time for a bulb-type artefact.

The result in figure 2 indicates that there are strong correlation between luminous flux and temperature of the test lamps. This can be confirmed in figure 3, where the luminous flux data in figure 2 are plotted as a function of the temperature data measured at the same time. This plot shows a clear correlation with a good reproducibility,

From the measurements in figure 2 and figure 3, we could conclude that the total luminous flux of the SSL products strongly depends on temperature, and we need more than one hour time for reaching a thermal equilibrium before we can measure their photometric quantities with high reproducibility. We applied this to the comparison protocol so that the measurement of total luminous flux should be performed after at least one hour of pre-burning.

For the SSL lamps we selected as comparison objects, the correlation between total luminous flux and temperature could be well approximated to be linear, as shown in figure 3. In this case, we can determine the temperature coefficient of each lamp by linear regression, which can be used to compensate the difference of ambient temperatures in the testing laboratories. In the example of figure: 3, the total luminous flux changes for more than 5 % for a temperature difference of 10 degrees.

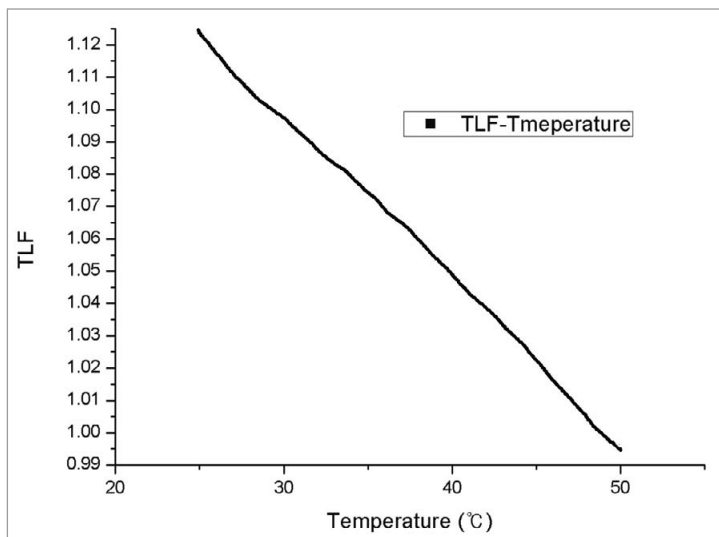

Figure 3: Plot of the relative total luminous flux as a function of the lamp temperature from the measurement data of figure 2.

Total Luminous Flux Measurement

We measured total luminous flux of the test objects in the two methods realized in KRISS. The first method is to use the KRISS goniophotometer, which is the primary standard of the KRISS total luminous flux scale. The goniophotometer measures the angular distribution of luminous intensity of the test lamp by scanning an illuminance meter at a fixed distance from the lamp. For spectral mismatch correction, the spectral power distribution of the test lamp and the spectral responsivity of the illuminance meter are also measured.

The second method is to use the KRISS 2-m integrating sphere photometer. The test lamp is compared with a standard lamp in the integrating sphere. The standard lamp is an incandescent bulb whose total luminous flux is calibrated by the KRISS goniophotometer. Careful correction of spectral and spatial mismatch between the test and standard lamps is important to achieve high accuracy using the integrating sphere photometer [1].

The measurement uncertainty of the SSL products used as comparison objects was evaluated to be smaller than 2%, and the results of the two methods showed an agreement within 1%.

Stability in the Comparison

In the comparison, the test objects are circulated to seven participants in a star configuration. KRISS measured the total luminous flux before and after the measurement of each participant. The duration of the comparison was approximately one month, and the artefact lamps were always hand-carried.

Figure 4 shows the relative change of the total luminous flux measured in KRISS for the two test objects during circulation. The drift of the test objects is less than 1 %, which is smaller than the measurement uncertainty of KRISS. We also confirmed that the burning characteristics and temperature coefficient shown in figure 2 and figure 3 showed no significant change during circulation.

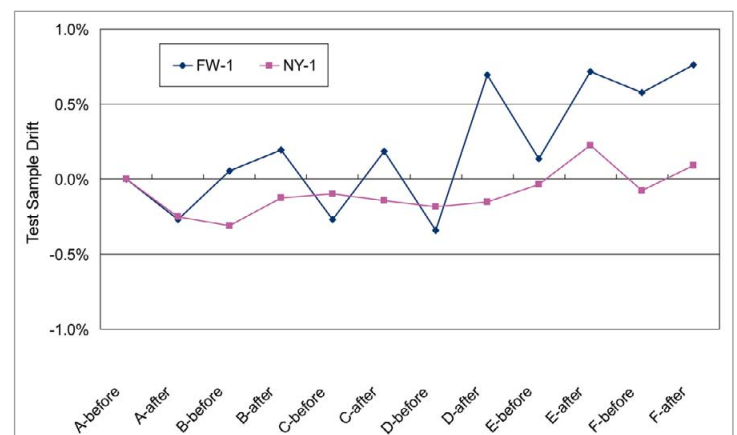

Figure 4: Plot of the relative change of total luminous flux for a bulb-type (red) and a down-light type (blue) artefact during the circulation for comparison.

Conclusion

We prepared test objects for a domestic round robin comparison on total luminous flux from the commercially available SSL products. By recording the temperature of the lamp together with the luminous flux, we could confirm the strong correlation between the photometric quantity and the temperature of the SSL products. By considering the characteristics measured in the pre-burning stage, we could achieve a lamp stability of better than 1% during circulation between seven laboratories in one month. ■

References

1. IESNA LM-79, Approved method for the electrical and photometric testing of solid-state lighting devices
2. <http://www.lightingfacts.com>

Acknowledgements

The authors acknowledge the support of Industrial Source Technology Development Programs (Contract #: 2009-D-001-01) by Ministry of Knowledge Economy of Korean Government.

Technology

LED Failure Modes and Methods for Analysis

> Holger Pross, RoodMicrotec GmbH

LED's open the way to new applications and markets in various different fields with a broad spectrum of requirements. Beneath other beneficial characteristics, in general, LED's provide a high reliability, and a lifetime of more than 50,000 hours can be reached. Poor workmanship in manufacturing and unfavorable operational conditions may reduce the reliability significantly. To avoid failures or to achieve fast resolutions of existing problems a good knowledge of the failure mechanisms and suitable analytical methods is required. Objective of this article is to provide an overview of state of the art techniques in LED-Failure analysis.

LEDs – Principal Function and Technologies

The LED-chip as the central element of the LED is a semiconductor that generates light in a PN-junction by electron p-hole recombination. The active zone is a complex structure of epitaxial layers. For different colors differential material-combinations are used: InAlGaP - red, InGaN - blue, GaAlAs - IR, AlGaIn - UV. The material and the quality of the epitaxial layers essentially determine the efficiency factor of the generation of light.

The primary parameters for the function are current and temperature T_j within the active layer, influencing both the power consumption and the color, which significantly determine the lifetime as well.

LEDs are available on the market in different technologies. Essential and important criteria are a stable current path through bonding- solder- and glued connection, a sufficient cooling of the chip by a good thermal contact to the environment or appropriate heat sink, as well as a high extraction of light from the LED by optical elements and areas of reflection.

LEDs are encapsulated in general with transparent material like silicone or epoxy. For white LEDs phosphor is added to convert blue LED in a broadband, white appearing spectrum.

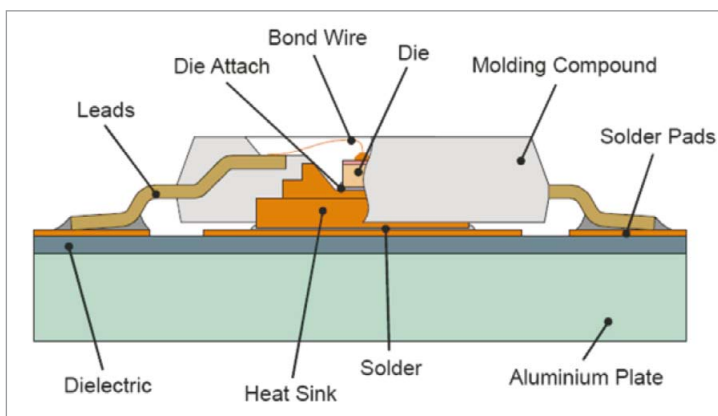

Figure 1: Example for a LED package on a PCB, showing the main components.

LED – Failure Modes

The defects occurring on LEDs can be related to different categories which are: the chip, as the central element and the internal and the external packaging. Due to the very different assembly technologies and types of constructions, as well as varying applications, an extended range of failure mechanisms can be observed.

Failure modes: Chip

During normal operation optical performance of LEDs gradually decreases during lifetime. In turn, this means a limitation in lifetime. Performance decrease is caused by growing defects in the epitaxy layers or on their boundaries, resulting in an increase of not radiating recombination and a decrease of optical efficiency. Usually a 30% or 50% decrease of optical performance is defined as defect while expected operation life is between 20,000 h and 100,000 h.

Ageing due to extension of defects is considerably dependent on junction temperature T_j and current. Therefore a sufficient control of these parameters is imperative for reaching expected lifetime.

Accelerated ageing, i.e. LED efficiency loss within a period lower than expected life, is caused by adverse factors like low quality of epitaxy layers as well as, often, an excess junction temperature due to insufficient heat dissipation. Furthermore, penetration of humidity or other contaminants, latent ESD (Electro Static Discharge) damage as well as an instable power supply can result in an accelerated degradation of epitaxy layers.

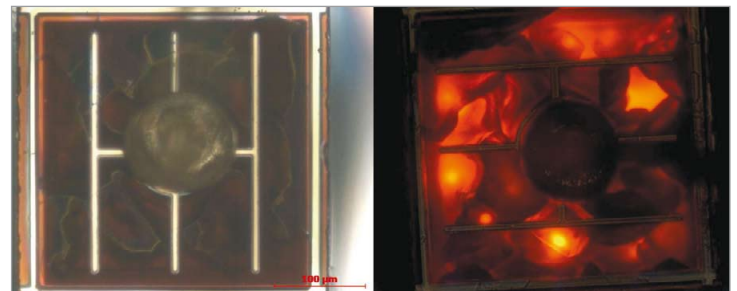

Figure 2: Reflected light (left) and transmitted light (right) microscopy of a typical surface corrosion.

A catastrophic defect like a sudden failure can be caused by ESD or EOS (Electrical Over Stress) due to electrical overload resulting in a serious damage of the epitaxy layer.

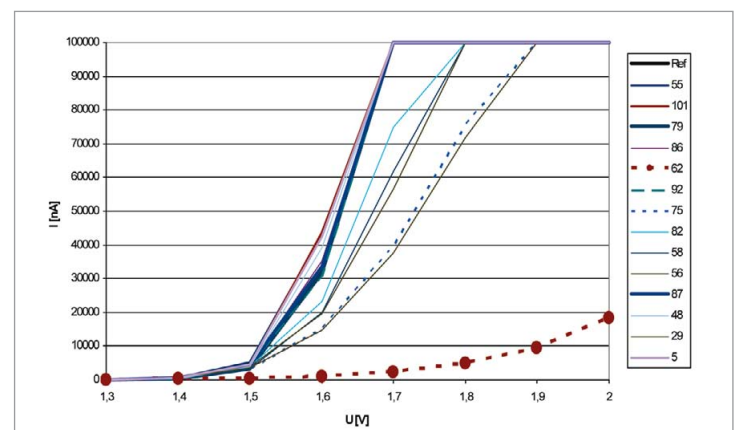

Figure 3: General characteristics (current/voltage diagram) for different diode types.

Failure modes: LED internal construction

Interruptions in the current path respective the increase of electrical resistance have turned out to be frequent failure causes leading to reduced light emission, temporally instable function or even the entire failure. Delamination in the junctions between the chip and bond wire respective the chip and the substrate have also been detected. Since the interface area of the chip to substrate bond essentially influences heat dissipation, disruptions of the interface layer cause an increase of thermal resistance and chip temperature. Consequently, this leads to accelerated ageing of the LED.

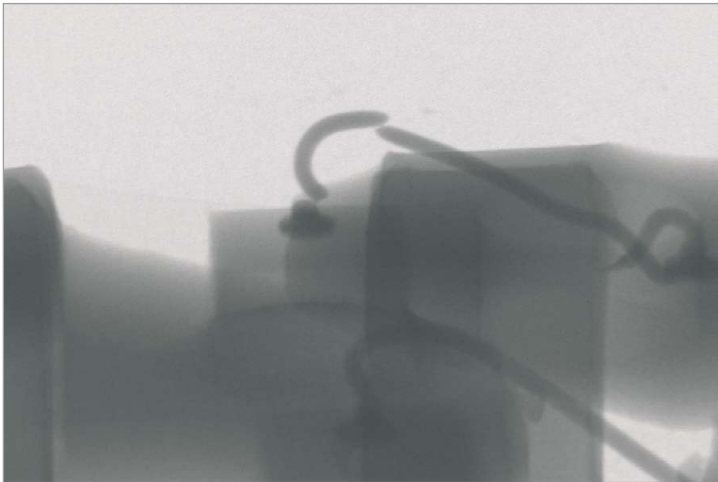

Figure 4: X-ray microscopy image of a broken bond wire.

In the LED production process are many failure sources to be considered. The soldering process has turned out to be especially critical because thermal overload can cause cracks, detachments or delaminations along the border areas due to the various expansion rates of the materials. Extensive qualification tests and stable quality control at the LED manufacturer as well a very good control of the solder process during PC assembly are basics for a long lifetime.

Transparent encapsulation materials like silicone or epoxy are not hermetically sealing and therefore do not protect against humidity or other damaging materials. Furthermore, mechanical stress, for instance while bending the pins of 2-pin-LEDs, or thermal stress like the soldering process, can cause cracks or detachments of the LED joint compound and allow penetration of contaminants down to the chip or metal contact. Under adverse conditions this will result in modifications of the epitaxy layers or in corruptions in the interfaces. Another effect would be the already described consequences due to detachment of the electrical joints or the performance degradation due to damaged reflecting surfaces.

Other typical mechanisms that lower the useful lifetime are the ageing of encapsulation materials influenced by UV-radiation, or the degradation of the phosphor of white LEDs, which is also responsible for a color change of white LEDs (known as yellowing). This effect is more intense than the regular ageing of a chip.

Failure modes: LED external assembly

By integration of LEDs in an external assembly, for instance in a PCB (Printed Circuit Board), more failure sources like malfunctions of electrical joints due to bad solder contacts must be considered.

Especially for high power LEDs, thermal contact and heat dissipation are very critical effects impacting degradation. The assembly should ensure and guarantee stable thermal contact during complete life.

Since humidity in LEDs, especially during the soldering process, may lead to the so called „Popcorn-Effect“, moisture-proof storage should be ensured.

In some applications the LEDs are covered by a protective lacquer or an external joint compound. Mechanical or thermal stress, as well as a reaction with outgassing materials can cause failures in the internal construction of an LED.

Methods for Analysis

LEDs present a broad range of failure modes which can be approached by using different methods of analysis. The objective of the failure analysis is to be able to allocate the observed failure pattern to a possible root cause and then show a way to avoid it. Because of the complexity, a failure analysis puts high requirements on technological know-how and the availability of methods for analysis.

Approach to find errors:

- Questions: In which environment was the LED/Module operated? For how long? Which driving mode was used?
- Measurements: Current/Voltage curves, intensity of light, wavelength/ color, radiation characteristics
- Non-destructive analysis: x-ray, light optical microscopy, scanning acoustic microscopy
- Destructive analysis: cross-sectioning, opening the package
- Physical analysis: FIB/REM, OBIRCH / Emission microscopy, EBIC, cathodoluminescence

In order to limit the extent of the examinations, it makes sense to develop an efficient strategy that will cover the most comprehensive amount of historical information at the beginning of the failure analysis.

Visual light microscopy inspection

The visual inspection provides information about the external construction, the external integrity of the LED package and accessible parts of the internal construction.

Opto - electric measurements

Essential opto-electric parameters are the optical power, the spectrum (color), and the current-voltage characteristics.

The radiation characteristics in the far- and the near field discover the inhomogenities of the light emitting area. Measurements of thermal resistance show problems in the thermal coupling.

Increased voltage in the forward direction points to a disturbance in the current path. Increased leakage current in reverse bias is a sign of a severe disorder in the epitaxy layers. This could be caused, for example, by ESD. The comparison of fine structures in the current/voltage curve between failed and working LEDs can help to differentiate between the various causes of errors.

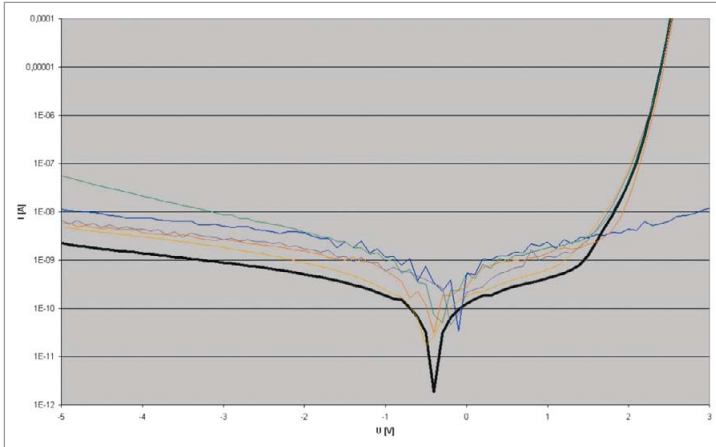

Figure 5: Example of current/voltage curves from failed LEDs (Reference: bold).

Other non-destructive procedures

Because LEDs are usually packed in plastic housings, detachment of the bond wire of the LED chip can be detected by using a x-ray microscope. The scanning acoustic microscopy is also suitable for identifying delamination on the interface.



Figure 6: Detachment of bond wire from the chip – x-ray microscopy.

Destructive physical methods

To localise failures inside the LED, direct access to internal parts like the LED-chip or bond interfaces is required. Cross-sectioning or removing encapsulant materials by using chemical solvents are adequate treatment methods.

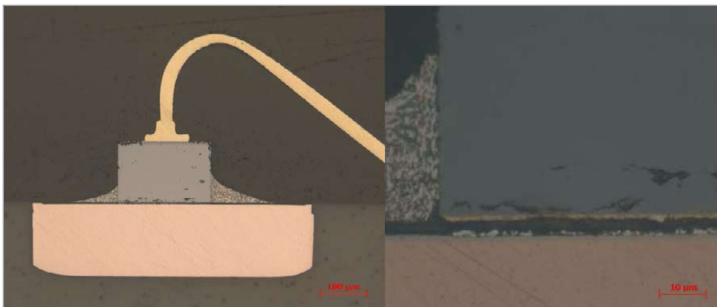

Figure 7: Microsection shows the detachment of the chip from the substrate of a bond wire (magnification on the right).

The inside structures are then accessible for high definition optical or SEM microscopy, and failures at the interfaces can be detected. Material analysis with EDX can determine impurities in the case of corrosion effects and give an indication to possible causes.

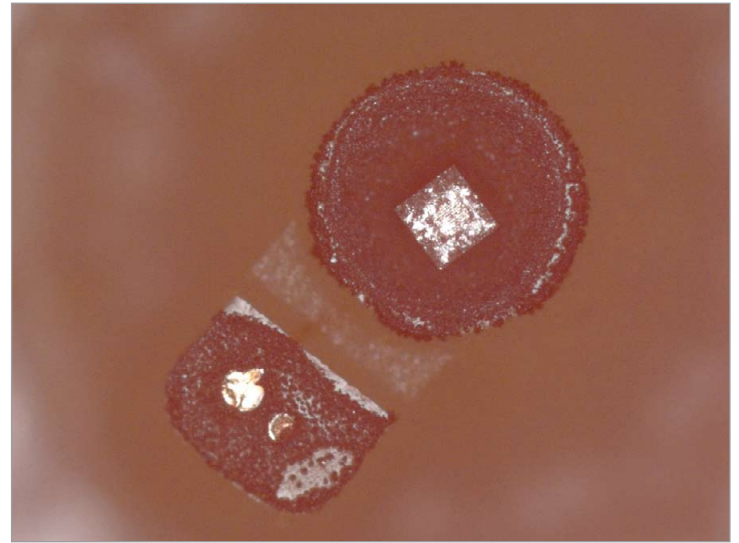

Figure 8: Corrosion of the interface bond pad and chip / chip bonding.

Failure analysis on chip level

To localize failures on chip level, methods are available that reveal defective areas on the chip, like dark spots or dark lines. Such methods are based on localized stimulation of light emission (cathodo luminescence) or current flow by pointing an external electro beam (EBIC) or laser beam (OBIC) onto the chip. Emission microscopy uses very sensitive detection of light created by leakage current.

Special methods like TEM (Transmission Electron Microscopy) and sample preparation using FIB (Fused Ion Beam) are required for the deeper analysis of failures in the epitaxy system layer. Evaluation of the results require the possibility for comparisons to the known error patterns and good models because the defective structures within the semiconductor are very dependent on technology used. Therefore these methods are very expensive and only used in special cases.

Summary

Basically, the reliability of LEDs is very high, but also dependent upon technology, construction technology and application requirements. The article shows the typical failure mechanisms, various types of analysis steps and with the results of this, ways to avoid future failures can be determined.

A good knowledge of typical failure modes will help to provide highly reliable LED products.

To gain this knowledge, it is necessary to adopt a systematic approach to isolate the failures, to use suitable procedures and methods for the analysis, to apply the correct way to generate and interpret error patterns of LEDs and, very importantly, to take preventive measures in order to avoid any possible problems. ■



POWER



LIGHTING



WATER



NUCLEAR

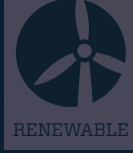

RENEWABLE

PUT YOUR BUSINESS IN THE SPOTLIGHT

LIGHTING

at Middle East Electricity

Exhibit alongside the industry's leading lights at the essential energy event of the year

Secure your place at the Middle East's ONLY industrial, commercial & residential lighting showcase

8-10 February 2011

Dubai International Exhibition Centre,
United Arab Emirates

Call: +971 (0)4 336 5161

www.middleeastelectricity.com/lighting



Optics

Considerations for Choosing a Miniature Spectrometer for LED Measurements

> Ryan M. Flaherty, Principal Scientist; Jason D. Pierce, Applications Scientist; Michelle Dean Ritchie, Applications Scientist; StellarNet, Inc.

Overview

As the global LED industry continues to evolve in commercial interest and continued advancement in solid state lighting technology, there is a fast growing need for reliable LED test and measurement systems. These systems were previously limited to R&D and QC applications due to cost and complexity of the instrumentation. However, tremendous progress in the development of low cost, miniature systems have provided a solution for LED manufacturers, LED product integrators, and the numerous applications in between.

Reliable and accurate testing systems ensure high quality of the LED product. These new systems generally consist of a miniature grating based spectrometer, a light collecting accessory (e.g. spheres, receptors, lenses), optical coupling fibers, and sophisticated software to collect, interpret, and display the data.

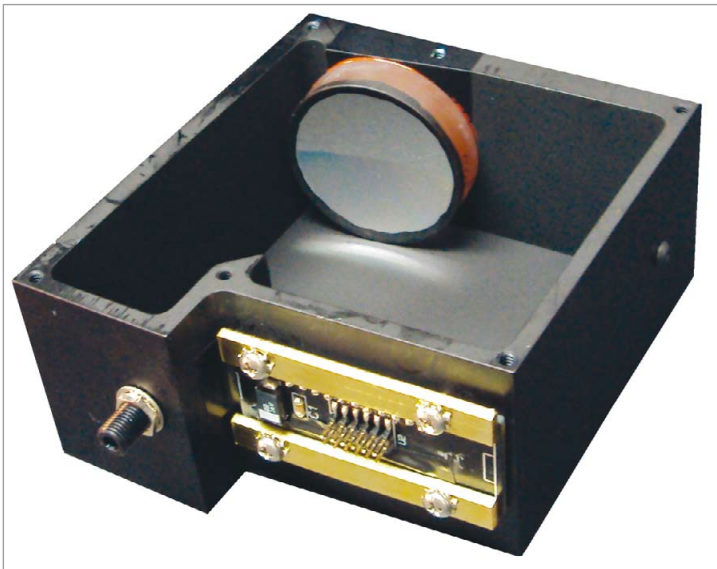

Figure 1: Concave grating optical bench.

It is important to examine all aspects and evaluate the technical specifications of the main components. The miniature spectrometer, at the heart of the system, is the most critical component in terms of accuracy, repeatability, and longevity of the system. The main technical considerations to be evaluated include spectrometer ruggedness, stability, linearity, signal-to-noise, stray light, and ability to remove aberration. Additionally, it is important to evaluate the light collecting accessory and

determine requirements based on the specific application. Lastly, computer interface and sophisticated yet simple to use software and user customization capabilities are extremely important factors when choosing the best low cost LED measurement solution. This article describes measurement technologies used for selection of the ideal LED test and measurement system.

Instrument Ruggedness and Stability

The most important component of the system is the miniature spectrometer. The basic principle is to collect the light, diffract it via the grating, and image onto a charge-coupled device (CCD). The electronics then convert the light to a digital signal to be read by the software supplied with the spectrometer. The main advantage of a low-cost, miniature spectrometer is the fact that most contain no moving parts, which translates to ruggedness and shock-proof durability. Additionally with a few select manufacturers, there are no electronics in the optical bench while the CCD detector is bolted to the exterior of the bench (as opposed to being placed in a socket). Concave grating optics provide the best performance in terms of stability since the grating design allows it to be permanently attached to the optical bench, bypassing the use of turrets which can be easily subjected to shock and vibration (figure 1). These units are then further ruggedized by placing the spectrograph in an extruded aluminum enclosure. However, many low cost systems use delicate enclosures for both the optics and electronics which are very sensitive to shock and damage. The main advantage of using fewer unnecessary parts is portability and in process environments where vibration or shock would damage normal spectrometers. This also reduces the need for regular re-calibration since there is little to no change in the optical alignment inside the unit. The end result is less down-time if the unit needs to be sent back to the manufacturer for repair.

Temperature Stability

Wavelength stability as a function of temperature is important for all spectrometers, especially for field measurements or environments not held at a relatively constant temperature. This can be tested by analyzing Mercury-Argon gas emission lines along with heating or cooling the spectrometer from a range of 10°C - 20°C. If monitoring a series of wavelengths across the range of the unit, there should not be a shift as a function of temperature. High performance spectrometers utilize optimal thermal designs and stabilization circuitry to minimize baseline and wavelength drift. Although this may not factor in heavily for R&D applications where the spectrometer is in a controlled environment, it remains another source where stability of the measurement instrument can play a factor in obtaining reliable data.

System Linearity

Miniature spectrometer system linearity is one of the most important factors that contribute to the overall accuracy and performance of the LED measurement system. The miniature spectrometer must be linear with respect to both exposure time and signal strength. One of the most beneficial tools of a grating based spectrometer is its large dynamic range and thus its ability to adjust exposure time. For bright LEDs the detector exposure time is reduced while for weak LEDs the time is increased in order to achieve maximum detector signal without saturation. To produce accurate results the detector must be linear with respect to exposure time. For example, a full signal at 800ms if reduced to 400ms will be half the intensity. Likewise

light

MIDDLE EAST

The Middle East Region's Leading Trade Show
and Conference for Urban, Architectural, Theatrical
and Retail Lighting Solutions

October 31 – November 2, 2010

Dubai International Convention and Exhibition Centre
Dubai, United Arab Emirates

www.lightme.net

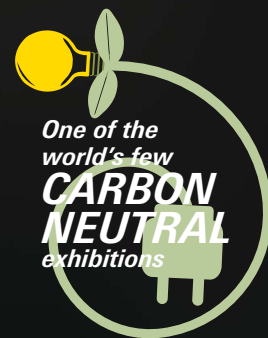

messe frankfurt

further reduction to 200ms will yield only one quarter of the original signal. It is important for the spectrometer to be linear with respect to changing exposure times; it is the basis for the instruments large dynamic range and one of the most important factors contributing to instrument performance. Secondly, system linearity with respect to signal strength is also of extreme importance. As a signal is decreased the spectrometer must linearly respond. As an example of this linearity performance, two products were compared; a StellarNet UVN-SR spectrometer versus a competing product (herein called Competition 1) which uses a 7th order polynomial to characterize the CCD detector, known as a Linearity Correction (LC) factor. The basic specifications are shown in table 1.

Model	Wavelength Range	Signal to Noise	Detector Type
UVN-SR	200-1100 nm	1000:1	2048 element CCD
Competition 1	200-1100 nm	300:1	3648 element PDA

Table 1: Basic specifications of tested units.

Each unit was measured at 546nm using a series of Neutral Density (ND) filters which have unique absorption profiles and produce spectrally flat transmission lines (obtained by differing each filters' thicknesses). The optical density, D, is defined by the following equation:

$$D = \log_{10}(1/T), \text{ or } T = 10^{-D}.$$

Filter	ND	%T (546nm)	Competition 1 with LC	Competition 1 without LC	UVN-SR
NE01A	0.1	79	79.535	79.534	77.412
NE03A	0.3	50	58.336	58.136	54.54
NE05B	0.5	32	32.648	32.415	30.375
NE10B	1.0	10	11.78	11.557	9.929
NE13A	1.3	5	6.485	6.338	5.23
NE20B	2.0	1	1.521	1.204	0.951

Table 2: Percent transmission data for each unit using Thorlabs filters.

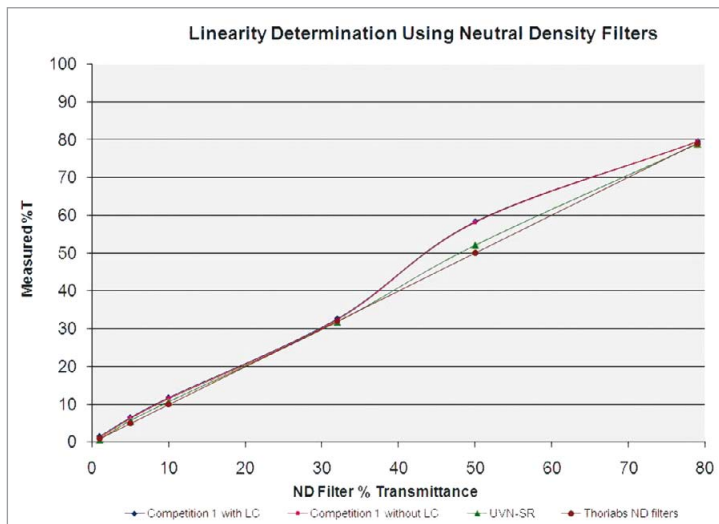

Figure 2: Plot of percent transmission data from tested units vs. ND filters.

Spectrometer	Regression	% Linearity
UVN-SR	0.996	99.586
Competition 1 with LC	1.051	94.888
Competition 1 w/o LC	1.049	95.099

Table 3: Regression and linearity results from plotted data.

The results from table 3 show that the unit with the best linearity was the UVN-SR model with a value of 99.59%, while the competition had an average linearity value of 94.99%. Although the linearity correction function is intended to improve the linearity via software, testing results show that this actually decreases it. The higher linearity values obtained by the UVN-SR unit can be attributed not only to a robust optical design, but also factors such as superior electronics employing low noise circuitry and advanced cooling schemes. Another important consideration that attributes to increased linearity is the reciprocity of the spectrometer. When analyzing any spectrum, the measured signal should decrease proportionally to the integration time. Testing can be easily carried out by measuring the peak value of an LED spectrum using the full scale integration time, then decreasing the time by factors of two and recording the value at the same peak. An optimal system design with show that the output value follows a linear decrease as the signal does.

Signal-to-Noise Ratio (S/N)

As the name suggests, the S/N is a ratio of the amount of signal measured compared to the amount of noise inherent in the system. Higher values mean better performance, improved accuracy, and most notably a smoother spectral output. A spectrometers detector and electronics must be optimized to reduce the affects of noise. In miniature spectrometers, CCDs (Charged Coupled Device) and PDAs (Photodiode Array) are the most common detector types. These detectors are responsible for converting photons into an electric signal. The electronics of the spectrometer then convert this analog signal to digital data for retrieval by the PC. Thermal noise and shot noise are the main contributors to system noise. Thermal noise originates from thermally induced motions in charge carriers and shot noise is noise injected by electrons and other charged particles crossing junctions.

The signal-to-noise ratio (S/N) of a signal can be enhanced by either hardware or software techniques. Expertise in electronic design with the optimized use of grounding, shielding, difference amplifiers, and analog filtering all contribute to reduction of the unwanted noise. For example, the electronics ground plane can lead to unnecessary noise if the plane is too small. The placement of these electronic components in close proximity causes a reduction in the S/N value. Also, to increase S/N, a miniature spectrometer must have an optimized signal across the wavelength range of interest. This is often overlooked in many specifications; it is important to understand that each system has an associated sensitivity curve that governs the maximum signal at a specified wavelength. All components of the system contribute to this sensitivity; however, grating and detector efficiency are the most dominant factors. Dual blaze and concave gratings optics in addition to applying special detector coatings are some of the techniques used to allow for uniform sensitivity and thus signal across a wavelength range.

In addition, software techniques such as sample averaging and spectral smoothing can be used to improve S/N. By sample averaging, the systematic characteristics of noise are reduced. If $(S/N)_0$ is the original signal-to-noise ratio of the signal, the final $(S/N)_f$ after N sample averages (scans) is given by the following equation:

$$(S/N)_f = (S/N)_0 \cdot \sqrt{N}$$

For example, by averaging 100 data sets a 10-fold reduction of noise level is achieved. Additionally, smoothing methods such as Pixel Box Car and Savitzky-Golay can be used to improve S/N. Pixel Box Car averages

adjacent pixels and Savitzky-Golay performs a least squares polynomial fit on a small set of consecutive data points and takes the calculated central point of the fitted polynomial curve as the new smoothed data point. When selecting a miniature spectrometer system, it is important to consider these hardware and software functions.

Signal-to-noise ratio testing can be performed in a few simple steps. The detector exposure time is set to full scale illumination using a standard tungsten halogen lamp. Save 10 dark spectra and 10 sample spectra with the light source on. S/N can be easily calculated by dividing the mean by the standard deviation of the 10 scans for each respectively. Higher quality instruments will show a standard deviation that is the same at maximum detector illumination compared to the dark reference. For example, in a system with 4000 total counts, if 4 counts is the calculated standard deviation, the corresponding S/N is 1000:1. Lower quality instruments with the same maximum counts typically show 13-15 counts of noise resulting in S/N of 300:1.

Stray Light Rejection

Stray light is light in an optical system, which is not intended by design. For a miniature spectrometer system stray light manifests as an unintentional signal across a wavelength range caused by light scatter and various internal reflections in the optical bench. This light drastically reduces system performance by causing photometric inaccuracy and it often sets a working limit on the dynamic range of the system.

Special consideration must be taken to reduce the effects of stray light in a miniature spectrometer system.

A miniature spectrometer's optical configuration and grating must be optimized to reduce the levels of stray light in order to yield the most accurate results. By far the most efficient technique to reduce the unwanted stray light is by using a holographic concave grating optical configuration. Holographic gratings have a smoother surface than normal ruled gratings, which are a primary source of grating generated stray light. Additionally, concave grating designs have two distinct advantages of grating scatter elimination and rediffracted light prevention. Standard Czerny Turner and Fastie-Ebert optical designs collect and concentrate light via the focusing mirror toward the exit port. By focusing its own scattered light into the focal plane it is ultimately detected as a signal. Concave gratings do not use mirrors and by design therefore do not exhibit this behavior. Rediffracted light occurs when light is diffracted by the grating and unintentionally redirected back to the grating a second time. When an instrument's optical design contains collimating and focusing mirrors, it is probable the light will be rediffracted and again measured as a true signal. Careful design effort, including low grating groove densities (<600 grooves per millimeter/mm), is necessary to prevent rediffracted light. The concave grating enhancements translate to improved stray light values of 0.02% at 435nm and 0.2% at 200 nm compared to standard configurations which yield values of <0.1% at 435 nm and <0.05% at 600 nm.

Stray light can be verified and quantified in a spectrometer by using a series of stray light reference materials consisting of filters or solutions. These materials are specially configured to stop transmission of light below a defined wavelength. Therefore, any indication of light transmission below the specified cut-off wavelength will be defined as stray light. Testing for stray light is important even if the spectrophotometer is not used in measurement below 260 nm because it is an excellent indication of overall system performance.

Reduction of Aberrations

All spectrometers are not created equally on the inside and concave aberration corrected holographic gratings are gaining in popularity for a number of benefits. One way to understand this is to examine the main types of aberrations common in optical systems and how they can potentially impact the end results. In standard optical designs, a phenomenon known as coma causes asymmetrical broadening of spectral lines once the light is diffracted and is collected by the detector. The most common cause of this is from using internal optics which are off-axis and the result in severe cases can lead to stray light and loss of system resolution

Another result from the use of off-axis optics is called astigmatism which causes a broadening of the spectral image so that it no longer matches the height of the CCD detector. This mismatched spectral image ultimately results in much of the signal not being measured, which decreases sensitivity important for low-light applications. Aspheric optics can be used in non-concave grating optical designs, but this often leads to lower light transmission and/or inner-surface reflections and stray light.

These two main aberrations, left unaddressed can cause degradation of the system performance and include a loss of resolution and increased stray light. By utilizing concave grating optical designs, uniform resolution is delivered across the entire spectral range, allowing for more precise data. As no mirrors are used to send the light to the detector, the lowest possible stray light values are obtained which is crucial in most all spectroscopy measurements. What should be noted is that the resolution is constant throughout the entire spectrum as opposed to the typical Czerny-Turner designs where only the center wavelength can be in focus. Lastly, the concave grating provides aberration correction for superb optical imaging into the detector array and creates extreme sensitivity (as much as two times higher signals) below 400nm.

Light Collection Accessories and Software

Low Cost Accessories

Before the emitted light from the sample enters the spectrometer (via fiber optic cable), it must be first collected by some type of optical device. The two most common types of accessories used in LED measurements are cosine receptors and integrating spheres, each with their own advantages. By knowing which one can be used for a particular application, additional money can be saved while still providing high performance. For applications measuring small arrays or for fast process applications, the cosine receptor is designed to correctly determine light intensity regardless of the direction and is the lowest cost alternative. This can also be used for applications involving high brightness or light sources that have to be measured from a distance.

More common in LED measurement applications is the use of integrating spheres which are generally more expensive and can involve elaborate configurations based on the customers' needs. These feature highly reflective internal coatings to uniformly collect and diffuse the light so it can be captured and quantified, no matter which direction it is emitted. Larger spheres containing internal baffles are of particular importance with arrays or unmounted LED's which can emit light in non-uniform directions. The use of the sphere ensures that as much light as possible is collected and analyzed and can generally lead to higher accuracy measurements. Caution should be used in selecting the correct as sphere as low-cost spheres can be used for most general measurement applications ranging in size from 2" to 20" in diameter.

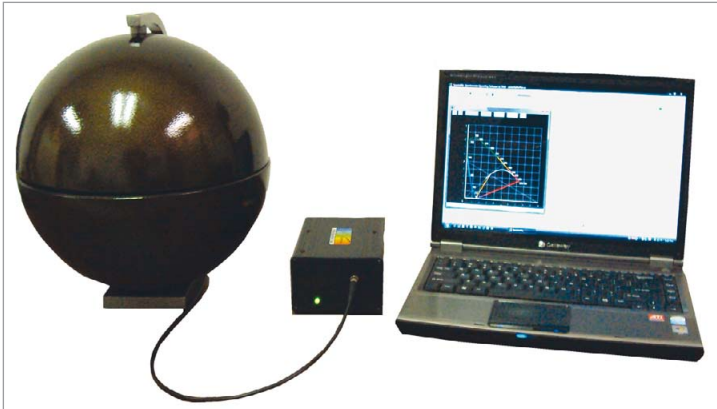

Figure 3: Example of a complete low cost LED measurement system.

others, by being equipped complete with demonstration programs code and accessibility to the instruments software driver. An example of this customization would entail LED binning where the hardware can be run by a user-tailored program to automatically record the peak wavelength and give a pass/fail rating for each LED.

Transfer Speed and Power Consumption

High speed data transfer is essential time series analysis and other applications which require external triggering and fast process monitoring. Most systems offer USB2 connectivity and feature advanced electronic designs allowing for plug and play connectivity. More advanced spectrometers can be powered solely by the user's computer and do not require external power which is ideal for portable measurement while the small footprint uses less space than comparable systems used in the past.

Software

Each instrument system is only as good as the software that's included. Most packages are basic in terms of output data, whereas more robust systems offer selectable measurement output data in optional units of watts/m², micro-watts/cm², lumens/m², moles per second, Footcandles/m², Radiant Flux (watts) / Luminous Flux (lumens), xy Chromaticity, CCT, and dominant wavelength. Optimal packages also include advanced features which lend the fiber optic based spectrometer to a variety of other applications by simply attaching different accessories, giving the user more versatility. A good software platform will also have easy to use features enabling non-scientific users to become acquainted with the basic measurement, but it should also be equipped with advanced features. Examples of this would be time-series analysis (measuring the LED output/stability over a defined time period), rapid sample logging, and allowing self-calibration system. Additionally, software customization is what will set some manufacturers apart from

Conclusion

As the consumption of LED-based products increases so will the increased need for manufacturing and research of these devices. Along with this manufacturing, there will also be a demand for low-cost, highly accurate measurement solutions.

Although there are many factors to be considered in the evaluation of an LED measurement system, it will help to look at individual specifications before purchasing. Internal optics should have low stray light values while maintaining a high S/N ratio, linearity, and sensitivity. The collection optics should be able to accommodate the sample under test while maintaining low cost to provide a reliable measurement. Finally, the software should be user-friendly, yet robust enough to provide advanced features should the user need them. By knowing what is most important to each measurement goal, the end user can be confident the equipment they purchase will give them the results they need and stay within budget. ■

Kingbright

www.kingbright-europe.de

+49 2835 - 44 46-0

New catalogue available!

OPTOELECTRONIC-ELEMENTS

XPower LED's

X-bright LED

Bar Graph Arrays

Displays

Dot-Matrix

Photocouplers

Photo Interrupters

Quality — Efficiency — Innovation — First-class service

Kingbright Electronic Europe GmbH • Lindenau 7 / Gewerbegebiet • D-47661 Issum • Phone: +49 (28 35) 44 46-0 • Fax: +49 (28 35) 44 46-29

LED FAIR

**THE ONLY LED EVENT
IN THE CENTER OF EURASIA!
LED SYSTEM, TECHNOLOGY AND APPLICATIONS EXHIBITION
30 SEPTEMBER - 3 OCTOBER 2010
İSTANBUL EXPO CENTER (WTC)
YEŞİLKÖY İSTANBUL TÜRKİYE HALL 9-10**

**THE FIRST LED
CONFERENCE
IN TÜRKİYE**



PAMUKKALE HALL 30 SEPTEMBER 1 OCTOBER
info: www.ledkonferansi.com

**THE FIRST
LED CONTEST
IN TÜRKİYE**



AWARD CERENOMY 30 SEPTEMBER 2010
info: www.ledyarismasi.com

www.ledfuari.com

SUPPORTERS



ORGANIZATION



Tel: +90 212 503 32 32 marmara@marmarafuar.com.tr

Drivers

Traffic Lights and Signage Need Intelligence

> Alex Zaretsky, Renesas Electronics Europe

The world is moving towards an eco-friendly environment where saving energy in any possible way is crucial. Manufacturers of electrically operated products migrate to switching mode power supplies and add intelligence to the systems to achieve this. Lighting applications are also migrating to LED based light sources, mostly because of their low energy waste and high efficiency, and traffic and pedestrian lights are no exception. From January 2006, traffic signals, pedestrian crossing lights and illuminated exit signs have had to meet Energy Star efficiency levels for input power of 5W and above. Although traffic and pedestrian signals were estimated to be the major application still using halogen lamps in 2007. This regulation created a transition to, and a demand for, LED lighting in these applications. To further support energy saving in LED lighting applications, as well as to comply with the European traffic lights regulations and be competitive in the market, more intelligence is required. This can be achieved by means of closed loop sensors, communications and efficient LED driving.

Traffic signals suppliers tend to provide energy efficient and sophisticated traffic lights that can also combine good optical quality with attractive design.



Figure 1: Traffic Signals - annual LED driver shipments for EMEA market (Source: Datapoint Research).

There are different traffic lights systems available on the market today including traffic signals, stop signals, pedestrian crossing lights, traffic displays and street lights. Most of the basic systems are supplied by a distribution power block which is located in a central control unit. The control block provides DC power supply to the traffic signal heads using conventional power cables where a simple ON/OFF type of signal is used. The distributed power spans 12V, 24V, 40V and 48V DC. Since different countries have different regulations, the supplied voltage to the traffic signals depends on the country and its standard luminance requirements. For example, to comply with the UK market requirements for traffic lights, 48VDC has to be provided for each unit.

Some traffic lights are supplied directly from 230VAC mains. Most of these are systems that also implement a counter signal head in addition to the usual three red, green, and amber traffic signal heads. The countdown signal is implemented with a couple of LED strips within the signal head that display the countdown value on the 7's in red or green colour accordingly. The countdown value indicates the time in seconds remaining until the system switches to the next light phase, thus contributing to better orientation and less risky behaviour of both pedestrians and motorists at intersections. This is useful for providing information to the drivers and helping them to be prepared to move or to stop. The counter signal head usually has its own integrated LED driver where the actual time interval between the counts and the 7's algorithm is also implemented. For the other three signal heads, the LED driver is normally located inside a control block. Many manufacturers build each 7's with 42 LEDs, where 6 LEDs are used in each segment of the 7's display.

It is well known that basic traffic signals are equipped with the three colours red, green and amber. However, in many cases the red light contains some orange in its colour, and the green light has some blue colour. That is to provide some support for people with red-green colour blindness. This kind of system requires extra intelligence and multi-colour support where the light intensity is properly calibrated and then dimmed to a certain level to produce the right hue.

Today's traffic lights are also equipped with intelligent sensors for detecting and counting passing vehicles. The sensors are used to improve the performance of traffic lights and adjust the time between different light colours accordingly. The sensors are used to detect crossing pedestrians or cyclists so the traffic lights can be changed accordingly. Another important use of the sensors is to deal with traffic jams. If a traffic jam occurs, the system can trigger the traffic lights to change earlier than usual to help disperse it.

There are also systems with sensors that are interruptible and are capable of giving priority to special traffic such as ambulances or police vehicles. This kind of system can detect an approaching emergency vehicle with sirens in operation and change the lights accordingly. The sensors used in detecting the pre-emption are usually based on wireless, infrared or optical transmitters that send a request to the lights controller to change the lights accordingly once an approaching emergency vehicle is detected. Some systems also utilise audio sensors which are capable of reading a certain type of siren and used to detect approaching ambulances that way.

To optimise traffic flow, traffic lights manufacturers also implement sensors to detect vehicles and bicycles with a metal rim approaching a pedestrian crossing or junction. They then change the lights accordingly. The sensors are usually built with inductive sensors and work by detecting changes to the electromagnetic field.

When a vehicle enters the sensors' magnetic field, it causes the light to change. The crucial weakness of this type of detection is that a fault in the sensor device can cause the system to fail to detect cars waiting in a turn lane or cross-street lane when at a junction. This can cause a considerable, even indefinite, delay to the traffic as well as resulting non-compliance with the signal safety. Another disadvantage of this type of technique is the limitation in the type of vehicles the sensor can detect. Larger vehicles which comprise a metal such as steel can affect the sensors' magnetic field and trigger the system. However, this does not always work for small vehicles, such as motorbikes, without a proper sensitivity adjustment. Detection of a small car, a motorcycle or even a bicycle requires the detector system to be



FORUM LED EUROPE

CONFERENCES + EXPO

7/8 DECEMBER 2010

Lyon - FRANCE

Cité Centre de Congrès

THE INTERNATIONAL MEETING PLACE
FOR KEY PLAYERS IN THE LED INDUSTRY !



www.forumled.com



An event organised by



I'm interested in ForumLED 2010 - To be returned by fax to + 33 (0)4 37 40 31 69

Company: _____ Name: _____ Job title: _____

Phone N° : _____ Fax N° : _____ Email: _____

- I wish to exhibit on a stand of ____ Square meters
- I also wish to lead a workshop
- I wish to receive more information



Contact / information : Romain CLEVY Tel: + 33 (0)4 37 40 31 64

LED

adjusted so that it is more sensitive than is the levels typically required for normal vehicle detection. Modern detectors such as rack-mount and shelf-mount detectors offer multiple sensitivity levels for this purpose. Although the inductive sensor is the most common technique, alternative solutions can be laser based sensors or rubber hoses filled with air.

Very popular today are variable message signs that integrate proximity sensors to respond to nearby events, such as displaying the driver's speed or flashing a warning message as the car approaches. These systems are cheap to install and many of them are solar powered, making them ideal for accident reduction in areas where mains electricity is not available. The sensors are interfaced to the system controller in various ways. The output of analogue sensors can be read by an analogue to digital converter (ADC). Digital sensors, which are more common these days, offer serial interfaces such as Inner-Integrated Circuit (I²C) or Serial Peripheral Interface (SPI) to communicate to microcontrollers. The advantage of the I²C bus is network capability, where multiple I²C compatible sensors or other devices can be connected in a network. On the other hand, SPI offers a higher communication speed.

Some traffic lights are equipped with speed cameras as well, where an additional signal head is used to display the speed on the 7's of an approaching vehicle. There are many different types of traffic lights available today from different manufacturers. The combination of intelligence and high luminance in the systems helps increase traffic safety at intersections. The variety of choice allows customers to select the right systems to fit their application requirements as well as to comply with the regulations in their country.

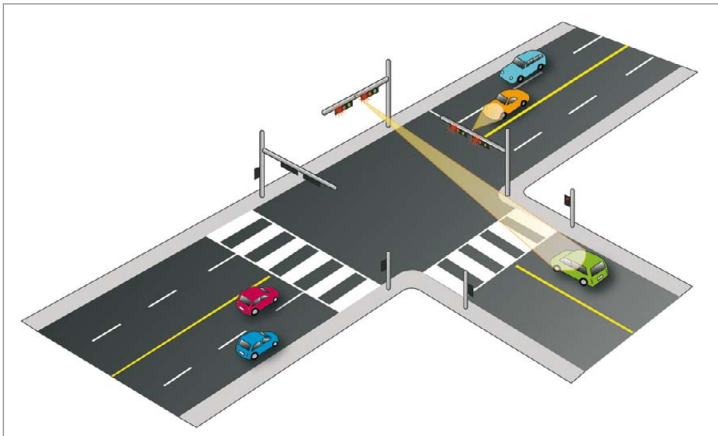

Figure 2: Intelligent traffic light with integrated sensors allow, for instance, speed control or presence detection.

Different manufacturers use various methods of implementing LEDs in traffic lights systems, thus reducing power consumption by 20% compared to halogen lanterns. Some of them only use two to five LEDs in each signal head of a traffic lights unit to produce the lights, saving both system cost and energy. Many traffic lights today also implement symbols within the signal head. These include a green arrow, which indicates moving forward is allowed when active, and the walking man symbol in crossing signals. They are for non-motorised traffic such as pedestrians and cyclists and are activated using LED backlighting. In some North and East European countries this additional signal head is also dedicated for public transport such as trolley buses and trams. This signal head is usually built with a

multi channel LED approach which allows the implementation of special traffic symbols for public transport. The actual picture of an arrow, a walking man or other signal is marked within the optical material at the time of manufacturing and is used as an optical enclosure for each signal head. When the LEDs on the back of the optics are lit, the light is only visible within the arrow, while the rest of the area within this signal head is not light conductive. Again, since fewer LEDs are required to produce the picture, the advantage of this type of approach is cost savings on the LEDs and the resulting lower energy consumption. Other manufacturers utilize dozens of LEDs in each signal head and use individual LEDs to create images and shapes within the head. The advantage of this type of approach is the flexibility and programmability of the images. It also enables the inclusion of moving objects on the signal head, where the matrix of LEDs within the signal head switches the appropriate LEDs to create the required image. To provide the level of brightness that complies with the local traffic authority's regulations, LED based traffic signals have to be dimmable. This allows the installers to set the required level of brightness.

As was previously mentioned, control systems are central control units that are used to provide power management and configuration services to traffic light systems. Most of the control systems can provide up to 900W, some of them even more. These control units operate all of the traffic lights in the location. So whether there are multiple traffic signals at a junction or a number of traffic signs fixed at a bridge, a single control system manages all of the traffic lights and traffic signs at that particular location.

Since different voltage levels have to be supported for different countries, these control systems include intelligent and configurable power supplies to provide a wide DC voltage range to fit variable voltage requirements.

Control system manufacturers implement a variety of HMI options for the configuration and programming of the traffic lights and signs. Many companies provide touch screens with a reliable operating system such as Linux, as well as several serial interfaces such as USB, Ethernet and RS485. These allow technicians to make configurations and upload bitmap data.

Traffic signs and variable message signs are used to display roadway information and are gaining wider adoption, thus improving driver information and safety while easing congestion as part of an Intelligent Transportation System (ITS). Sign types vary from simple signs, based on just a few one to three channel LEDs, which are mostly used within cities and other built-up areas. These include flashing speed limit signs, car park space and entry signs, and other warning signs. These have lower performance and LED lighting requirements but offer significantly higher growth in the market.

Large variable message signs for motorways, such as motorway information, inner city congestion and toll lane signs, are built with a matrix of RGB LED pixels to provide colour variation and the effect of moving objects, depending on the requirements. Every manufacturer has a different approach to designing large size LED based traffic displays, but the most common method is to divide the display region into pixel segments and implement a number of small identical drivers for each segment to control a number of pixels in it. These segment controls are centrally controlled by a main control system within the unit which is programmed with the message or bit map to be displayed. RS485 is a common interface among the majority of the manufacturers. It is used as a communications protocol between the main controller and the segment controllers which are pre-programmed with unique addresses.

One of the fastest growing markets for LED replacement is street lights. In the early stages of this developing market, it was considered that a single colour white LED approach was sufficient to satisfy the main requirements. However, it is worth noting that this is not actually the best option for human visual perception, which varies depending on the light conditions and even the location. Interestingly, photopic vision in a well-lit environment and scotopic vision at night overlap somewhere on the green/blue spectrum. At this point, the human eye has the best visual perception in low light conditions. It is therefore more efficient to produce light colour in the right spectrum, allowing better visibility while saving energy. For example, human visual perception is different in the countryside to how it is in the city. In the countryside, the eye requires more of a green hue in the lights, but more red in the city where there is a more brightly-lit environment. Different developers take different approaches to resolve this, but it is common to develop a multi channel LED driver to satisfy the colour mix requirements. To further contribute to energy saving, producing the right mix of colours allows a higher level of brightness with lower energy consumption. Many street lamp manufacturers today also implement proximity sensors that automatically dim or brighten the lights, depending on whether a presence is detected within a certain radius of the lamp. There are also lamps with integrated ambient light sensors which can automatically adjust the brightness of the light according to the ambient light level. All of these features add intelligence to systems and, most importantly, contribute to significant energy savings.

Although LEDs offer significant advantages such as life longevity, power to light efficiency and low voltage operation, two of the inevitable disadvantages of LED technology today are their light degradation, which typically starts occurring with time, and colour shifting with temperature change.

Unfortunately, all manufactured LEDs have different characteristics which LED driver designers have to take in to consideration when developing LED power supplies for traffic lights and other industrial LED based lighting products. In traffic light systems, street lamps and other LED lighting products, the ability to detect the start of any light intensity degradation is essential. This is to ensure that the light output level is compliant with the required European regulations for the minimum brightness of traffic signals, such as ECE65. The system can be configured to automatically compensate the light output level by increasing the current through the LEDs once degradation is detected. This can be achieved by constantly monitoring the current through each LED channel. Up to date lighting microcontrollers, like the Renesas products, integrate up to 9 channels of 10-bit ADCs and up to 3 channel comparators that can be used to monitor currents and adjust the PWM outputs accordingly in multi-channel as well as in single channel LED systems. Another important aspect to look at is LED failure detection. This can be crucial in LED based traffic signals since the system has to be protected from accidentally lighting the wrong colours. Also, one of the main advantages of adopting LEDs for street lights is their life longevity which reduces maintenance costs. The system has to be able to detect the LED's failure and act accordingly. Therefore it is important to be able to monitor the system for LED failure as well as for excessive current and temperature. These lighting microcontrollers integrate dedicated peripherals to allow the required protection procedures in the system. Many manufacturers also use multi-channel LED drivers to support the traffic signal heads and street lamps with extra LEDs, should one of the channels fail.

The most advanced lighting-specific microcontrollers integrate LED driver dedicated peripherals to facilitate integration and cost savings. They provide a single chip solution both for power stage control and for driving a number of LED channels without involving the CPU. ■

THE WORLD'S LARGEST EXHIBITION FOR OPTOELECTRONICS

THE 12TH CHINA INTERNATIONAL OPTOELECTRONIC EXPO



LED EXPO

SEPTEMBER 6-9, 2010

SHENZHEN CONVENTION & EXHIBITION CENTER • CHINA

CONCURRENT EVENTS



**OPTICAL COMMUNICATIONS,
SENSORS, LASERS &
INFRARED APPLICATIONS EXPO**



PRECISION OPTICS EXPO



global sources
IIC China
Conference & Exhibition

CHINA INTERNATIONAL OPTOELECTRONIC EXPOSITION OFFICE

Add: Room 607, East Block, Coastal Building, Haide 3rd Road,
Nanshan District, Shenzhen, Guangdong, 518059, China

Tel: +86 755 8629 0901

Fax: +86 755 8629 0951

E-mail: cioe@cioe.cn

Special Topics

Distributor - Arrow: From Drivers to Diodes - All from One Single Source

> Stephan Wegstein, Sales Director Lighting - EMEA, Arrow Central Europe GmbH

The lighting market is clear proof of the change currently rippling through the distribution sector. Distribution has long outgrown the simple provision of individual components coupled with logistic services, and now positions itself as a comprehensive solution provider, offering thorough consulting and guidance. With its comprehensive approach, the global distributor Arrow Electronics addresses the markets of interior and exterior lighting, signage and portable lighting, and transportation and backlighting. A European lighting team brings dedicated and specific knowledge gathered over many years to the market, and in addition to supporting classic distribution customers, also offers guidance to those yet to take their first steps in distribution, such as lighting designers, street lighting developers and even towns and local authorities which opt for innovative technologies for communal lighting.

With a clear focus on LEDs as the source of lighting for the future in all areas, Arrow is firmly committed to the aim of not only offering its customers a wide selection of suitable and necessary components and comprehensive guidance, but also an elaborate network of partners capable of meeting all requirements. Factors such as the long useful life, energy efficiency and performance serve to increase the attraction of LED lighting. In addition to long-term cuts in costs, CO₂ savings are also a convincing argument in favour of the use of LED technology. In times of high energy prices and ever-growing environmental requirements, effective alternatives to current lighting products are indispensable. EU directives such as the regulation on replacing incandescent lamps with energy-saving light bulbs fortify technological advances further. Nevertheless, high investment prices prevent an explosive increase in their use. Alongside this financial aspect, which will certainly witness positive developments for customers in the near future, the design of LEDs, with their precise colouring, light exploitation and accuracy, is still undergoing constant optimisation, which obviously requires specific guidance and support in accordance with the area of application in question.

Distributor as Implementation Partner

With headquarters in Melville, New York, and more than 11,300 employees, Arrow Electronics, Inc. is a global provider of products, services and solutions for industrial and commercial users of electronic components and computing solutions for businesses. Arrow Components, which is a Fortune 200 company, was founded in 1935, and is represented in Europe with 76 branches in 31 countries. For selected growth markets such as lighting, Arrow has established dedicated teams which have already been consolidating the necessary expertise for years. In the area of Components, Arrow acts as a broadline distributor to offer its customers a wide product

portfolio spanning analogue and digital semiconductors, passive and electro-mechanical components, plug connections and embedded solutions (Arrow Embedded Solutions). The embedded area focuses predominantly on displays, power supplies and wireless technologies. With this portfolio, the distributor is able to offer all required lighting solution components from one single source. The company's linecard also features all renowned manufacturers. Alongside the 'core' business, which generally includes large OEMs (original equipment manufacturers) and EMS suppliers (electronic manufacturer services), Arrow operates two further organisations which are directed especially towards special customer target groups with specific requirements: Arrow Alliance addresses the complex requirements of large OEMs at a global level. Customers with small and medium product quantity needs are served by Arrow Advantage. Overall, Arrow has more than 900 companies on its linecard. Global market leaders stand alongside highly-specialised niche players.

Technical Support

One special feature of distribution is the customer service provided by application engineers, who accompany the customer's development department on-site throughout the entire product life cycle. Arrow employs more than 250 of these field application engineers (FAE) all over Europe. These representatives offer support to customers in Design-In projects, which have been growing in significance within the industry for years and form the basis of future industrial applications. In turn, they are supported by further product and technology specialists. Marketing and business development experts advise customers on the optimal selection of components and work together with them to create complete solutions and systems for the whole application.

For developers of complex semiconductor applications, Arrow has created the development programmes Embedded Platform Concept (EPC) and Testdrive. The EPC is a modular system application with various boards and engineering services. Testdrive offers developers the opportunity to borrow a range of evaluation boards for a specific period and test them in accordance with their requirements. Numerous renowned manufacturers participate in this initiative.

The Entire Application in View

Given that LED technology is becoming increasingly interesting for an extremely wide range of end markets, the distributor Arrow has formed a core focus in this area all over the world. With the whole application in view, Arrow supplies all components required by the customers. This includes plug connectors, drivers, suitable power supplies and thermal management solutions, in addition to diodes and corresponding optics. For this, more than 50 complementary products from various manufacturers are available. This ensures that the dedicated Arrow lighting team can support the introduction and further development of LED solutions. Product specialists from the areas of analogue (LED drivers), power (including MOSFETs) and microcontrollers (PNW/networking) implement their knowledge precisely where it is needed. This procedure forms a solid basis for the development and implementation of a convincing and successful LED concept. The distributor maintains an overall view and is able to recommend suitable components. In this new and innovative market segment, expertise in technology and all of its facets is a hugely significant factor which should not be underestimated. After all, many customers have either no or limited knowledge of such areas, which is

available completely free of charge from the distributor. It is equally important to have partners who, rather than being desperate to sell technology at any price, analyse its purpose and suitability in relation to the project at hand. Another key aspect is integration in existing scenarios.

Behind the provision of all necessary components and technical support stands a powerful logistic organisation, which not only involves local requirements in terms of demand, but also the global supply chain. Special market requirements such as environmental regulations (RoHS, REACH, WEEE, etc.) are complied with in full. Arrow's logistics specialists ensure that customers receive the most efficient solution. The aim here is to establish a secure and long-term requirements plan which, using the corresponding logistics model, ensuring stable and reliable relations throughout the delivery chain. Customers in Central Europe, for instance, receive their goods from one of the world's largest warehouses for electronic components, the Distribution Logistics Center (DLC) in the Dutch town of Venlo. A particularly attractive feature of the organisation is that customers have access to all services through one single contact in the sales department. This contact person then consults other technical staff and resources if necessary.

The LED Challenge

LED technology still has to face a few hurdles before fully establishing itself. One reason for this is the sharp contrast between starting positions. The spectrum stretches from companies which have already been working intensively with LEDs for over ten years to others which have not had any contact with this technology, but which are, based on the contemporary energy discussion, looking for solutions to clinch a place on the market with innovative products. Traditional lighting, whether for external or internal areas, is supported by well-established standards which are not yet, or only to a limited extent, available for innovative LED lighting. One challenge faced by all market participants is how to demonstrate that a really 'innovative' lighting solution with LEDs can be amortised. All too often, one comes up against process boundaries, such as different decision makers for investment costs and maintenance costs, or the difficulty to measure changes in areas like 'accident frequency' or increased 'performance' through the LED lighting feel-good factor. Alongside the purely technical considerations, these decisive factors certainly also play a role in determining how quickly LED lighting will consolidate itself.



Figure 1: An example out of the LED portfolio of market leaders (Source: Osram Opto Semiconductors).

Selection of Market Leaders

The presence of optimal consulting and support at every stage of the product's development cycle is absolutely crucial. Arrow offers this, and helps customers to arrive at an appropriate product selection and solution. In addition to 'standard' components and parts which a distributor offers in their portfolio, customers can also obtain individual 'modules' from Arrow. This ensures that a good product idea in the initial phases of product development can be supported in order to guarantee the rapid presentation of a solution at a trade fair, event or to a customer. Depending on the customer's decision, these 'modules' can also be supplied in large quantities. An elegant solution for customers who do not have their own development department for an electronic ballast, for instance.

Arrow draws on a wide-reaching portfolio of market-leading companies and can therefore offer independent consultancy services. This includes Avago, CML, Cree, Everlight and Osram, in addition to Dow Corning, Fraen, Ledil, Khatod, Infineon, Linear Technology, Renesas, ST, Vishay and Zetex. The area of Arrow Embedded Solutions (AES) provides power supplies from manufacturers such as Emerson, Lightech, TDKLambda and Recom.

With Cree, Arrow boasts a manufacturer whose power LEDs could be used for a range of applications, including street lighting. Arrow collaborates with Cree, Osram and a range of external partners to develop special street lighting solutions, and can advise customers correspondingly. LED driver solutions are available from a range of producers, such as Fairchild Semiconductor, National Semiconductor, Texas Instruments, ON Semiconductor, ST Microelectronics and NXP. In addition to this, a comprehensive portfolio of passive components and mechanical parts such as switches, buttons and cooling elements from Fischer or Tyco Electronics are on offer. With this combination of manufacturers, distributors, OEMs, customers and applications, Arrow is in an optimal position to provide effective support at all stages right through to the final product. Of course, not all products are the same. The technologies used by the manufacturers offer different advantages depending on the area of application.

Example: Street Lighting

Street lighting is an excellent example of the expertise required for successful installation. In addition to this, innovation is quickly recognisable in the area of street lighting. In just a few years, our street lighting will be linked in a network, and will only provide full lighting where it is really needed. Complete street sequences will no longer need to be activated for maintenance purposes; lamps will be able to be switched on individually. Those who have already opted for LED lighting today will be able to retrofit their equipment with minimum effort and expense. This and many more technological innovations, coupled with extensive EU regulations or national laws, demonstrate the intense need for guidance - not to mention test tracks - which could, over the coming years, form a basis for decision-making concerning the future implementation. In many countries, governments have provided funds for the infrastructure within the framework of economic stimulus packages to combat the financial crisis. Alongside classic measures, numerous authorities are considering investments in new technologies to fight climate change and save related costs. This is where LEDs come in.



Figure 2: Offenbach Energy Supplies (EVO) pilot project to test LED street lights.

Towns and local authorities are particularly dependent on external expertise to provide reliable knowledge for installations. Offenbach Energy Supplies (EVO) collaborates with Arrow within the framework of a pilot project to test the new lamps in the municipality of Mainhausen. As the infrastructure provider, EVO AG sees the decisive driving force behind the project as the aim to identify solutions for future energy supply. Local authorities will benefit from significant cost advantages. Technicians from the area assume responsibility for the installation and technical maintenance.

In all areas of life, future lighting will change considerably. Modern high-performance light-emitting diodes and modules offer the opportunity to adapt the colour of the lamp to the specific physiological conditions. The countless advantages offered by LED technology should act as motivation to embrace this innovation today. Supporting the U-turn away from old, technologically outdated lighting, which in addition to poor efficiency, often contain environmentally harmful substances such as mercury, towards innovative and clean technology has become a central commitment of Arrow. ■

How Distributors Can Help to Speed Up Development:

Innovation Showcase: The Arrow Lighting Simplicity Kit

Arrow Electronic has partnered with Freescale Semiconductor to launch the Simply Smarter Design Solution, featuring an exclusive wireless control Simplicity Kit for lighting and embedded applications. Based on Freescale technology and products from industry leading partners, Cree, Digi International, and National Semiconductor, this showcase reference design and demonstration platform eliminates complexity, and reduces operating costs and time to market pressures in design and development.

The Lighting Simplicity Kit consists of two boards – the Control Board and the LED Board. The Control Board processes input from touch sensors and an ambient light sensor, and sends commands to the LED Board via an 802.15.4 wireless connection. The Control Board also displays status on low-power discrete LEDs. The Control Board can be either battery-operated, or powered from an external DC-power supply.



www.ledlightforyou.com

Our partners are looking forward to your ideas.

More than 50 partners world-wide await you in the LED Light for you network. These OSRAM-certified providers will be pleased to assist you in finding the right optical, thermal and electronic solutions for your lighting application.

The network for LED lighting technology.



The LED Board receives command from the Control Board via the 802.15.4 wireless connection, and adjusts the Solid State Light LEDs accordingly. The LED Board also takes a local temperature measurement, and makes the result of that measurement available to the Control Board. The LED Board receives power from an external DC power supply.

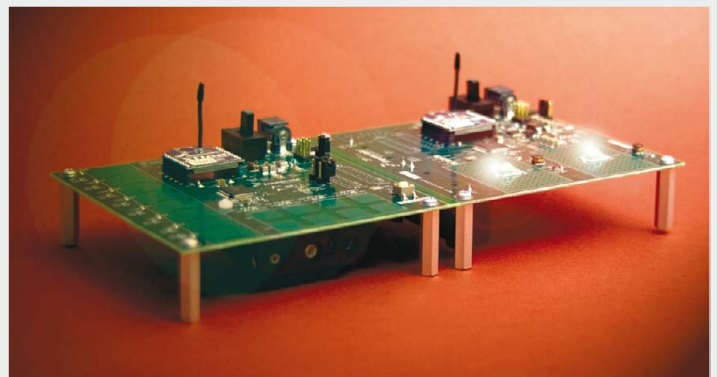

Arrow Simplicity Kit

LED LIGHTING GUIDE.

Engineering Competence for your complete Application.

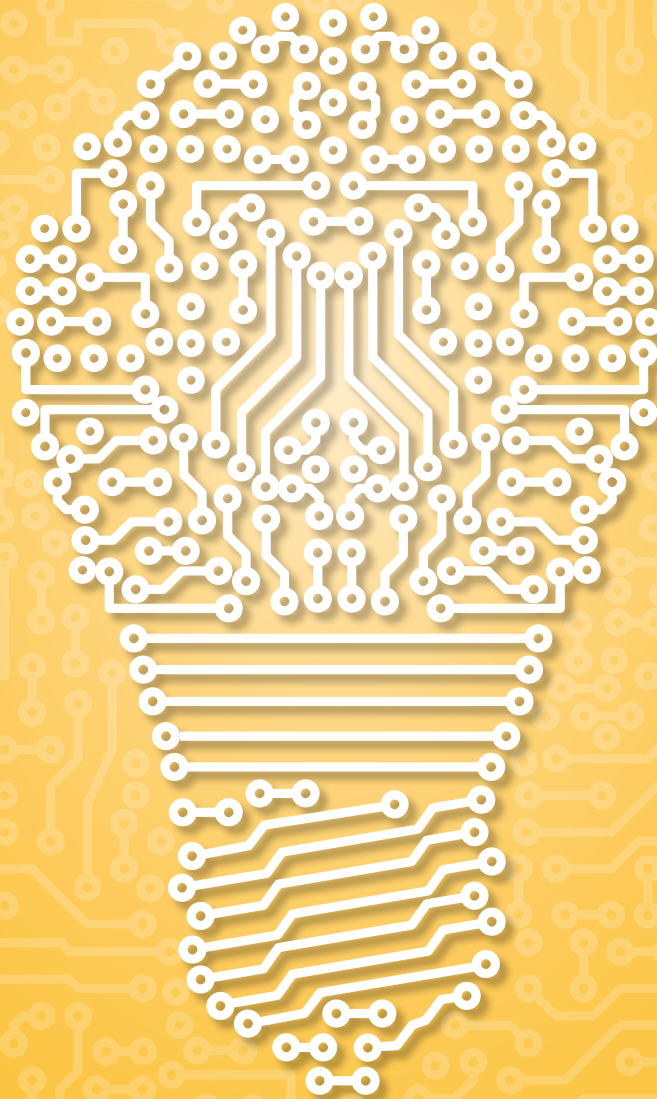

arroweurope.com/lighting

Arrow Electronics is dedicated to providing efficient and reliable LED system alternatives to traditional lighting. As a world-class global electronics distributor, Arrow Electronics offers a vast selection of products, services, and complete solutions to support your solid-state lighting needs from concept development to production. Arrow Electronics can meet or exceed all your lighting needs and accelerate your journey to market whether you need support for general lighting, portable, transportation, signage, or backlighting design.



To order our new Lighting Guide please contact: lighting@arroweurope.com

ARROW ELECTRONICS



TRIDONIC

▼ enlightening your ideas

TridonicAtco becomes Tridonic.

„I’m looking forward to
the future in a new light.“

Your light should be more than just good – it should be perfect. To achieve this claim, we provide you with support in all aspects of light and lighting. This support is based on our expertise in lighting applications combined with pioneering products, outstanding service and a huge passion for lighting. And we are underlining our commitment with a new name and a new appearance. This will put our position into sharper focus and make us unmistakable and easier to remember. Everything that made us excellent in the past has therefore been retained – and we can look forward to a future in which we continue to live up to our claim: We devote all our energy to your light. www.tridonic.com