

LED
professional

www.led-professional.com

ISSN 1993-890X

Review

LpR

The leading worldwide authority for LED lighting technology information

Sept/Oct 2010 | Issue

21

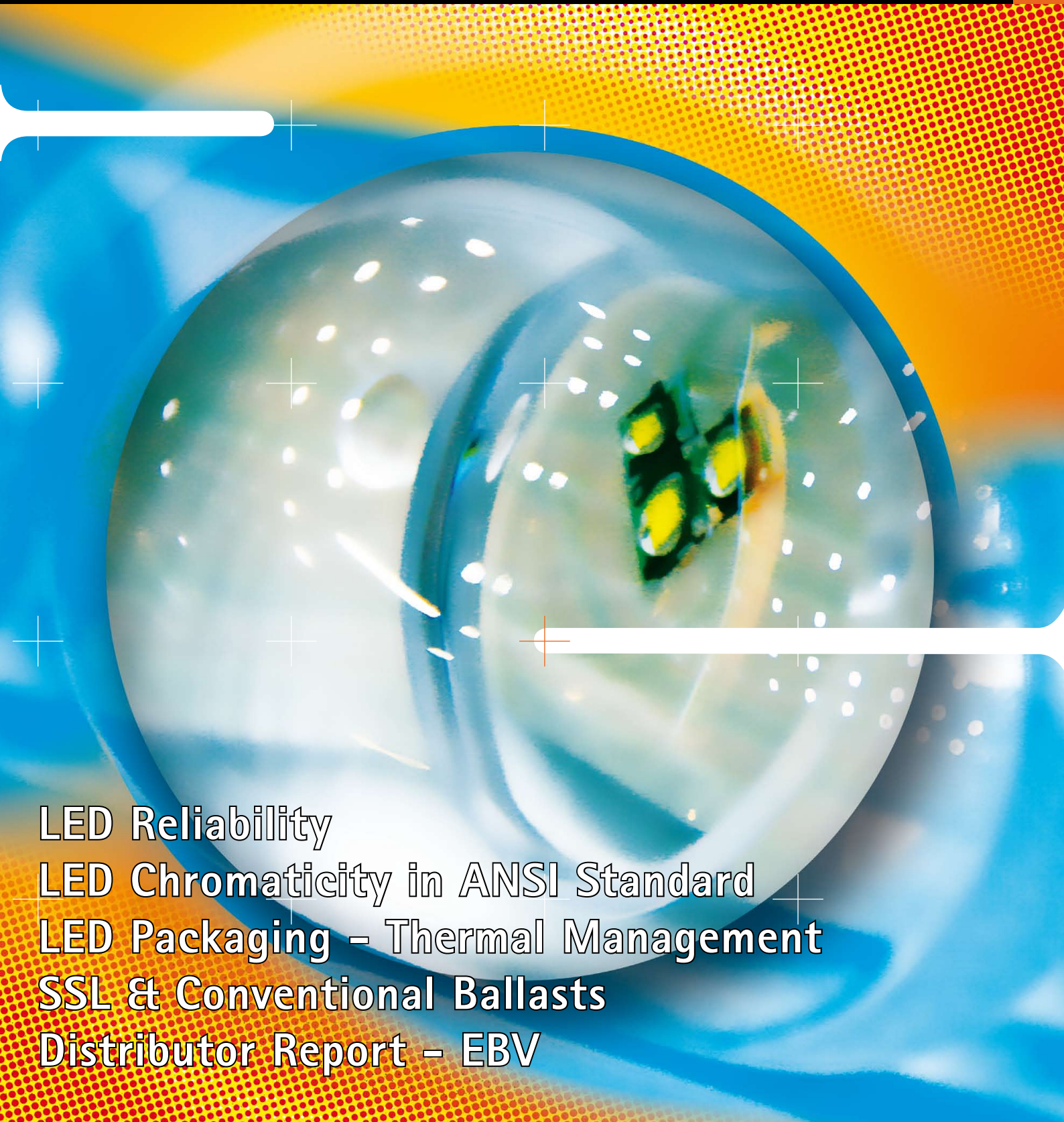

LED Reliability
LED Chromaticity in ANSI Standard
LED Packaging - Thermal Management
SSL & Conventional Ballasts
Distributor Report - EBV

Future Lighting Solutions

the company behind the downlight



We are the market leader in LED based Lighting Solutions.

Accelerate your next project with our engineering expertise. From design to concept to production, Future Lighting Solutions works with customers across the globe to deliver superior, future-proof lighting solutions.

Through our partnership with Philips Lighting, we'll help you incorporate Philips Fortimo™ LED light modules, which have a 5-year warranty and are designed to ensure that form factor, color, and quality remain consistent and sustainable over time.

Future Lighting Solutions has the tools, knowledge and experience to help you make the right decisions in specifying your LED lighting system solutions.



Visit FutureLightingSolutions.com and start your next LED project with support from the experts

Breakthrough of SSL in 2012



Dr. Jeffrey Tsao from the Physical, Chemical & Nano Sciences Center at Sandia National Laboratories is one of the leading scientists in Solid-State Lighting. This year he presented the research findings of his team at the Photonics West Conference and recently published a paper covering their investigations in detail.

They simulated an ideal light source derived from what is known about human eye behavior and defined the characteristics of a "100%-efficient" light source based on four distinct colors; 459 nm 535 nm 573 nm and 614 nm respectively, with a relative power of 18%, 24%, 23% and 37%. This ideal light source was optimized for a CRI of 85 at a CCT of 3,800 K and a luminous efficacy of 400 lm/W.

When comparing the "Ideal Light Source" to the light generation of lamps based on available lighting technologies, the incandescent lamps are only 3,5% efficient, LED lamps show a 14% efficiency (available component with 58 lm/W, CCT 3,100 K, 0.7 A) and fluorescent lighting's efficiency stands at 21%, all normalized at 1 W wallplug power. The efficiency of solid state lighting is still too low mainly because of three impacts: the efficiency of the blue LED with about 33%, the phosphor-conversion efficiency with about 54% and finally, the spectral efficiency due to human eye response (78%). This adds up to an overall efficiency of approximately 14%.

Dr. Tsao proposed three huge technology challenges to increase luminous efficacy, namely the elimination of blue LED droop for current densities up to 200 A/cm², to find a narrow-line width shallow-red conversion, and to fill in the red-yellow-green gap in the conversion spectra based on new or redesigned semiconductor materials.

The cost of light is dominated by the operating cost of light which can be calculated by dividing the cost of energy by the luminous efficacy. For traditional lighting (incandescent, fluorescent or HID) the operating costs are 6 times higher than the purchasing costs of the lamps. This means that for SSL as well, the most important factor for propelling further development is to improve the operating costs and therefore the efficacy. In 2008 the cost of ownership for SSL, calculated as the sum of purchasing and operating costs, reached the value of incandescent lamps. In 2012, cost of ownership for SSL will come in just below fluorescent lighting and HID.

What we can conclude from this study is, first of all, that we should pay special attention to the optimization of all system losses in a lighting system, and secondly, that we should be ready to take part in the big transition to SSL at the beginning of 2012.

Your comments and feedback about *LpR* is always appreciated. Drop us a line and tell us what you think and how we can improve our services. Don't forget that your own editorials are always welcome.

Best regards,

A blue ink handwritten signature of Siegfried Luger, consisting of several fluid, connected strokes.

Siegfried Luger

Publisher

Imprint

LED professional Review (LpR)

ISSN 1993-890X

Publisher

Luger Research e.U.
Institute for Innovation & Technology
LED professional dept.
Faerbergasse 15, Haus Rot
A 6850 Dornbirn, Austria/Europe
phone +43.(0).5572. 394489
fax +43.(0).5572. 394489 90
editors@led-professional.com
www.led-professional.com

Publishing Editors

Siegfried Luger
email s.luger@led-professional.com
phone +43.(0).5572. 394489 70

Arno Grabher-Meyer
email a.g-m@led-professional.com
phone +43.(0).5572. 394489 18

Account Manager

Theresa Koenig
email theres.koenig@led-professional.com
phone +43.(0).5572. 394489 20
fax +43.(0).5572. 394489 90

Local Contacts

<http://www.led-professional.com/contact-us>

Front-page picture

Ewo GmbH - street lighting module
Photo: A. Grabher-Meyer
Artwork: Thomas Klobassa
©LED professional 2010

Copyrights – Luger Research e.U.

The editors make every reasonable effort to verify the information published, but Luger Research e.U. assumes no responsibility for the validity of any manufacturers, non profit organisations or individuals claims or statements. Luger Research e.U. does not assume and hereby disclaims any liability to any person for any loss or damage caused by errors or omissions in the material contained herein, regardless of whether such errors result from negligence, accident or any other cause whatsoever. You may not copy, reproduce, republish, download, post, broadcast, transmit, make available to the public, or otherwise use LED professional Review (LpR) content without prior written consent from Luger Research e.U. – Institute for Innovation & Technology, Austria. ■



LED professional Review (LpR) – Annual Subscriptions LpR Digital Magazine

- 6 issues
- pdf download
- high resolution pictures and graphs
- printable
- commercial use
- access to all previous issues
- Euro 78.80
- <http://www.led-professional.com/subscribe>

LpR Printed Magazine

- 6 issues
- Euro 158.40

Next LpR Issue – Nov/Dec 2010

- LED Electronics

Content

Editorial	p1
Imprint	p2
Product News	p5
Research News	p26
Event News	p27

■ Applications	
SSL Adoption – Opportunities and Obstacles by David Hammel, Apos Lighting LLC	p30
■ Characterisation	
How Much Store Should the Lighting Industry Set by the ANSI Standard for LED Chromaticity by Thierry Suzanne, Future Lighting Solutions	p34
■ Technology	
Factors That Drive LED Reliability by Dr. Randy Kong, DfR Solutions	p38
■ Thermal Management	
Junction Temperature in Package Design – The Key To Optimal Heat Dissipation by Kay Fernandez, Lumex	p42
■ Drivers	
Ballasts and Drivers for Conventional and Solid State Light Sources Authors references shown on the article page	p48
■ Special Topics	
CO2 Balance Sheet: Aluminum Versus Alumina Ceramics by Dr. Meinhard Kuntz, CeramTec AG	p58
Distribution Today – All from One Source by Rudy Van Parijs, EBV Technical Development	p60

Advertising Index

Future Lighting	p C2
DSM Engineering Plastics	p 4
Cree	p 7
Sharp	p 11
Avago	p 15
Kingbright	p 16
Recom	p 19
StellarNet	p 21
Instrument Systems	p 23
Curamik	p 25
Jenoptik	p 26
Electronica 2010	p 28
Citizen	p 29
Seoul Semiconductor	p 33
Philips Lumileds	p 37
Forum LED Europe	p 37
Ocean Optics	p 40
Fischer Elektronik	p 41
Bergquist	p 45
Recom	p 49
Lighting Japan	p 51
LED China	p 55
Infineon	p 56
VDI Conference	p 57
Signcomplex	p C3
Tridonic	p C4



Stanyl[®] TC

Proven LED thermal management solution

Living Solutions by:
Proven Thermal Solutions
DSM Engineering Plastics

Stanyl[®] TC Thermal conductivity combined with design freedom for LED lighting

Stanyl[®] is a registered trademark of Royal DSM N.V.

Developing a polymer solution for thermal management in LED applications was a challenging task. But finally the DSM Knowledge Team has found a solution they can warmly recommend. With Stanyl TC the heat dissipation is brilliantly combined with design flexibility and the high productivity of polymer technology.

Stanyl[®] TC is rapidly establishing a position as the material of choice for the LED Lighting industry. It's the first thermally conductive plastic which has an optimal balance of mechanical performance and heat dissipation properties.

It offers lighting producers and designers the ultimate design-freedom, whilst providing all the necessary metal replacement benefits, such as weight saving, higher productivity, easy processing and overall system cost savings.

All this is made possible by the broad knowledge we can draw on, not to mention our endless curiosity and our care for a greener planet. With all the passion we have, we want to create proven innovations for generations to come. More information: www.livingsolutions.dsmepl.com

DSM Engineering Plastics

Unlimited. DSM

Product News

EPISTAR Achieves 135 lm/W White LED at 1W Operation

EPISTAR announces the development of a High-Voltage (HV) LED chip that enables 135 lm/W white LED at 1 W operation and has begun shipping its high-voltage (HV) chips to General Electric (GE), Philips, Osram and IKEA.

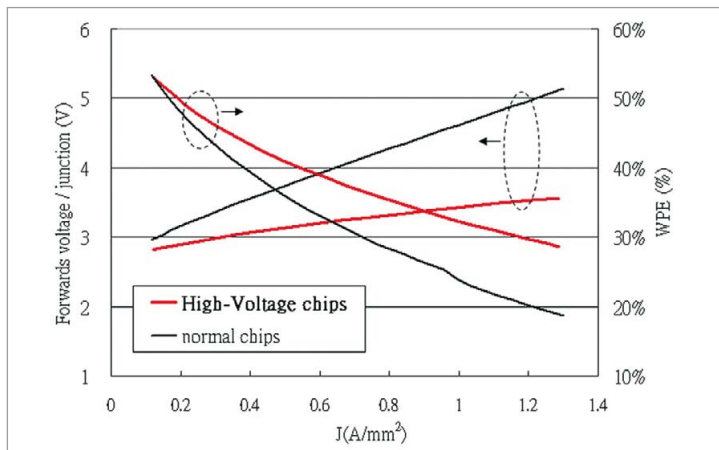

Epistar's HV chips have higher WPE and lower forward voltage as compared to normal power chips with the same chip size.

EPISTAR has developed a technology which enable a lighting applications to reach high efficacy using a single large, blue LED chip (size = 45 mil) eliminating the need for complicated packaging of many small-sized chips and their wires. This technology enables a white LED with efficacy of up to 135 lm/W at a color temperature of 5,000 K. to reach such high efficacy with the simplified packaging desired in lighting applications. EPISTAR developed a High-Voltage monolithically integrated DC multiple-chip array to significantly improve current spreading. Consequently, there is much lower forward voltage and higher Wall Plug Efficiency (WPE) at 5.5 W operation as compared to normal power chips. Packages of HV LED chips can be used in general lighting and any applications for high-efficacy white light.

HV LED shares common process technology with AC LEDs, with several high-voltage micro dies on it. The only exception is that it does not have a bridge circuit which strings all these micro devices to combine their voltages to fit the household 110-220 V AC power outlet. However, users can turn a direct current (DC) HV LED into an AC LED by adding an external bridge to the HV LED package.

The HV chip is reportedly less expensive than an alternating-current (AC) chip in high-power applications so Epistar is expected to increase the shipment of HV LED chips next year.

Epistar, Formosa Epitaxy Inc. and Philips Lumiled Lighting Co. have ventured into the HV LED sector. ■

Updated LUXEON® Rebel ES Now Delivers 300+ Lumens

Philips Lumileds announced advancements in its LUXEON Rebel ES product line that enable new outdoor lighting solutions to deliver higher efficacy and more light output which shortens payback periods, lowers the total cost of ownership and enables LED systems to meet new efficiency standards being implemented around the world.

Quick Facts LUXEON Rebel ES:

Typical efficacy 125+ lm/watt

CCT 4,100K and 5,650K

Typical forward voltage 2.85-3.10 V

Typical light output:

- 300+ lumens at 1000 mA
- 220+ lumens at 700 mA
- 125+ lumens at 350 mA



LUXEON Rebel ES enables even more efficient and cost effective outdoor lighting solutions.

At 1,000 mA, the new LUXEON Rebel ES delivers more than 300 lumens and efficacy of 100 lumens per watt. When optimizing for system efficiency, the current can be lowered and efficacy can exceed 125 lumens per watt. Either way or in combination, applications can be more easily designed to meet emerging outdoor lighting standards system cost targets, and cost of ownership requirements.

LUXEON Rebel ES is optimized for outdoor applications, including streets, roadways, tunnels, and high- and low-bay lighting, with correlated color temperatures (CCTs) centered at 4,100 K and 5,650 K.

The level of control and performance afforded by LUXEON Rebel ES is significantly beyond what's possible with conventional sources, shortens payback periods, and minimizes ownership costs for customers deploying these lighting solutions. LUXEON Rebel ES emitters deliver the reliability, robustness, longevity, and quality of light characteristics that LUXEON LEDs are renowned for.

Implementing energy efficiency continues to be recognized as the simplest and most direct route to reducing green house gases and reducing the environmental impact of energy consumption around the world, In China, North America, and Europe in particular, the implementation of LUXEON Rebel ES based lighting solutions helps governments, utilities, and facility owners achieve their 'green' objectives and significantly reduce their operating costs. ■

Cree XLamp® MX-3 LED: New Lighting Class

Cree, Inc., a market leader in LED lighting, announces commercial availability of the new 100+ lumen XLamp® MX-3 LED. The MX-3 LED extends Cree's lighting-class performance to a broader set of applications with enhanced light uniformity and LED-to-LED color consistency. ■



The Cree XLamp® MX-3 LED is ideal for LED bulbs, retail display and linear lighting.

MX-3 delivers luminous flux of up to 122 lm at 350 mA in cool white (6,500 K) and up to 100 lm at 350 mA in warm white (3,500 K). The MX-3 offers design simplicity and flexibility, sharing a common footprint with Cree's XLamp MX-6 LED, and is ideal for LED bulbs, retail display lighting and high-flux distributed illumination such as cove lighting and wall washing.

"The XLamp MX-3 is designed for customers who demand lighting-class performance across their entire product line," said Paul Thieken, Cree director of marketing, LED components. "With the industry's tightest color consistency and uniform angular chromaticity, Cree continues to set performance standards for longevity and consistency." ■

ProLight Opto Releases Crab Module Series for Downlight Replacement

ProLight Opto has recently launched a new module series (Crab module series) for commercial lighting applications, especially for incandescent bulbs and downlights replacement.

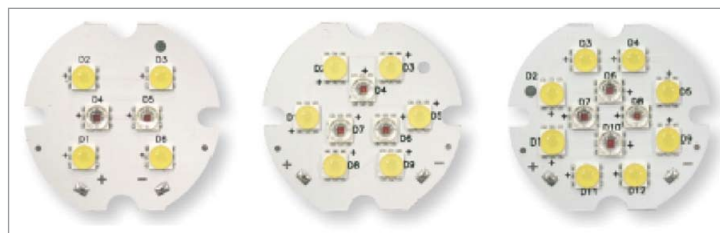

ProLight Opto's Crab Module Serie (from left to right:PP2M-1LYP-006BN, PP2M-1LYP-007BN, PP2M-1LYP-008BN).

Part No.	PP 2M - 1LYP-006BN	PP 2M - 1LYP-007BN	PP 2M - 1LYP-008BN
Dimension	Diameter 31mm		
Power	6 W	9 W	12 W
Flux(lm@2600k)	500	750	1,000
lm/watt efficiency	85 lm/W		
CRI	>90		
Forward Current	350 mA		
Forward Voltage	16.5	24.8	33

ProLight Opto Crab Module series performance data.

With a CRI of over 90, lumen efficiency per watt is up to 85 lm/W and options range from 500, 750 and 1,000 lm. The Crab modules are factory-mounted with pb-free reflow soldering on MCPCB all with the same dimensions (31 mm), and they can help luminaire developers to reduce both development cost and time to market. ■

New Design by HPI High Power LED Lightings

HPI introduced LED modules with excellent thermal performance, easy replacement and maintenance.

Viewing the existing LED market, most of the LED lighting products encountered a similar problem; poor heat dispersion which generates light degradation, color shifting, etc. In order to try to solve the problem, prices are raised. This, however, is not accepted by customers. We also see the same bottleneck situation with LED manufacturers. HPI LED T-Bar lightings have gone through experiments and repeated testing. The LED heat is dispersed through the aluminum base plate and the whole panel. While HPI's whole panel heat dispersion can be efficiently reduced to 30°C, its excellent thermal performance makes

★ CREE XLAMP® LEDs ARE THE

SIMPLEST

WAY TO CONSISTENT LIGHT.*



★ LIGHTING THE LED REVOLUTION™



OUR SINGLE TWO-STEP MACADAM ELLIPSE BIN DELIVERS INCANDESCENT-LIKE COLOR CONSISTENCY WITHOUT COMPLEX COLOR MIXING.

Find a Cree Solutions Provider or authorized distributor at www.cree.com/xlamp or call 800-533-2583.



up to **1500** lm
@ 20W
XLamp®
MP-L LEDs



up to **855** lm
@ 10W
XLamp®
MC-E LEDs

CREE EASYWHITE™
technology delivers pre-mixed LEDs to
your color and brightness specifications.
It's as easy as picking a lightbulb.

CREE 

Photos are illustrative only and may not depict actual installations. Cree, XLamp and the Cree logo are registered trademarks, and Lighting The LED Revolution and EasyWhite are trademarks of Cree, Inc.

the maximum temperature less than 40°C. This will extend the life of the LED and is HPI's innovation and strength.

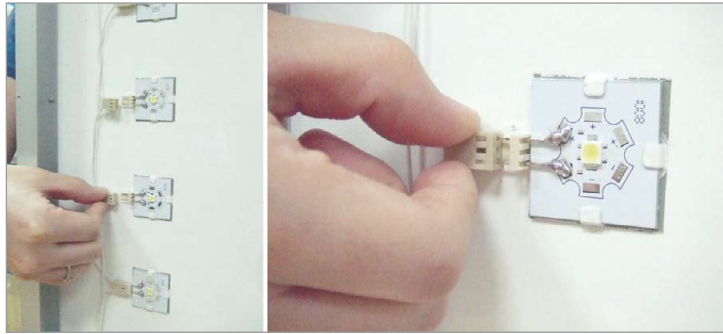

HPI's patented LED module systems allow easy replacement.

In addition HPI LED lightings uses a patented LED plug-in method, which allows LEDs to be easily replaced when one or more LED(s) fail. It is not necessary to ask for help from an electrician or discard the whole set if you can replace the failed one by yourself (DIY). However, DIY is not recommended in some countries due to law restrictions but maintenance costs will be reduced, nevertheless. The technology was designed by HPI and patented in Taiwan and China. ■

Eco Depot Unveils ICE PIPE High Bay LED Lighting Product

Eco Depot, Inc. announced the addition to their avantgarde product line of commercial and industrial LED Lighting solutions, a featherweight, super energy efficient, high lumen output 125 Watt high bay LED fixture - known as the ICE PIPE. The revolutionary ICE PIPE weighs 75% less than conventional halide lighting fixtures and can release heat exponentially faster than any other available LED technology. The new low cost ICE PIPE is designed to replace conventional 250 to 400 Watt metal halide lighting fixtures.

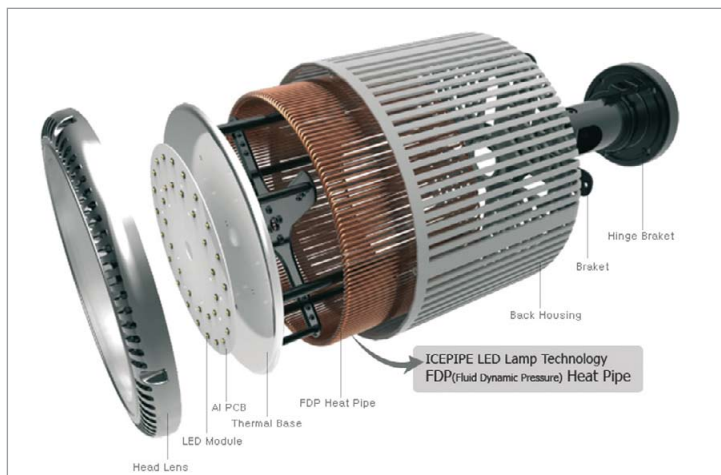

EcoDepot provides High Bay LED and Led Lamp Products with Zaanzi's proprietary heat sync - utilizing Fluid Dynamic Pressure technology.

The ICE PIPE technology ingeniously utilizes fluid dynamics in the creation of a revolutionary heat release system that deploys thin and durable capillary pipes to extract heat from the system instead of bulky aluminum or other alloy based heat syncs. This stand-alone system reduces the weight of the fixture by up to 75%, releases heat 100 times faster than standard copper heat syncs and allows Eco Depot to offer the world's first environmentally friendly mercury free 500 Watt LED light with a recorded junction temperature of 53°C!

"We can now retrofit a standard commercial 250 to 400 Watt high bay metal halide lighting system with ICE PIPE's 125 Watt LED system and offer superior brightness at 50% the energy cost and without any bulb replacement or maintenance for 10 years," stated Arthur Han, Special Assistant to Eco Depot's CEO.

Eco Depot also announced the finalization of a marketing, supply and development partnership with Zaanzi Co., Ltd of South Korea, the proprietary developer and manufacturer of the ICE PIPE product series.

Manufacturing for the ICE PIPE 125 watt LED high bay commences in early September and will be available for retail during the second quarter of 2011. Eco Depot plans on developing a line of new LED Lighting products with Zaanzi Co., Ltd., in the immediate future. ■

Cree Extends EasyWhite™ Technology to Its LMR4 LED Module Family

Cree, Inc. expands its LED Module LMR4 product line with the introduction of Cree EasyWhite™ technology and a broad range of available color temperatures.

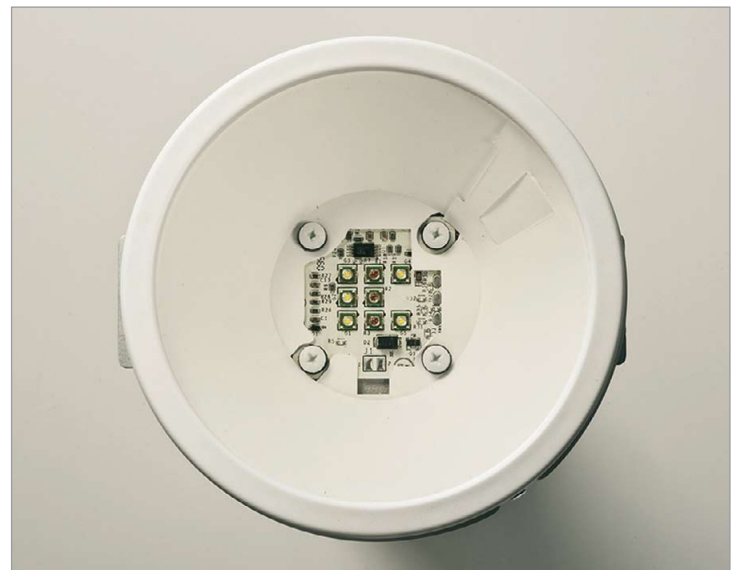

Cree's LMR4 module is now available with EasyWhite™ technology.

The larger LMR4 portfolio demonstrates Cree's commitment to accelerating the adoption of LED lighting by simplifying the design process and shortening time-to-market for new LED-based fixtures.

"The addition of EasyWhite options and additional color points gives us increased flexibility when designing fixtures," said Mark Danesh, President and CEO of DMF Lighting. "Since the LMR4 is drop-in-ready, we can now address more applications within a limited development budget; from general illumination to our most demanding customers such as restaurants or museums, which benefit from the higher light quality of Cree's TrueWhite® technology."

The Cree LED Module LMR4 with EasyWhite technology uniquely integrates driver electronics, optics and primary thermal management, making the compact Cree module easy to integrate and fast to market. Designed to last 35,000 hours while consuming just 12 watts of power, it offers 2,700 K, 3,000 K, 3,500 K and 4,000 K color temperatures at 80 CRI.

"Cree LED Module customers now have access to EasyWhite technology, allowing them to expand their design possibilities while shortening the manufacturing cycle for new products," said Scott Schwab, Cree LED Module product line manager. "This further broadens Cree's portfolio of application-optimized LED Modules, specifically designed to meet the needs of our OEMs."

The Cree LED Module LMR4 with EasyWhite technology is available in production quantities now with standard lead times. Also available are new module evaluation kits featuring four modules with a mix of Cree TrueWhite and EasyWhite options. ■

ALT Proudly Launches the Brightest LED Lamps in the World

Aeon Lighting Technology Inc. (ALT), the leading global manufacturer of high power LED lighting products, has proudly introduced its latest products—Aurora™ series V5 MR16 and Apollo™ series BR40 with the highest lumen in the world at 720 lm and 2,600 lm respectively, consuming only 7 and 35 watts of electricity.

Besides high lumen, the average lifespan of the Aurora™ and Apollo™ series can reach up to 20,000 and 40,000 hours. With such high lumen and long lifespan, both lamps are ready and able to replace traditional indoor lighting directly.

	10 min	20 min	30 min	60 min	90 min	120 min
Heat sink	52.2	56.3	58.1	57.3	56.5	57.3
Substrate	54.3	57.5	59.3	58.6	58.3	58.6
Ambient	23.1	23.5	23.7	23.5	23.2	23.6

Temperature testing results for Aurora™ series V5.

In order to produce high lumen and maintain premium quality and performance at the same time, ALT has spent countless hours and resources to develop the most efficient heat dissipation system. James Liang, the CEO of ALT, explains, "We proudly present our patented radiation-active-type exterior design for our products. The special radiation-active design enhances product heat dissipation ability dramatically." Baly adds "The exterior cast is made of pure aluminum, which is highly heat conductive" Moreover, ALT also has unique driver technology which means that the driver component is able to bear high working temperatures for the entire life of the product and largely increase product stability.

Advance heat dissipation and driver technology was the core reason for ALT to develop such a high luminous efficacy LED lamp. Based on Aurora's™, actual lighting experiment data of the temperature of the chipboard, after reaching heat equilibrium, it can maintain 58°C and the temperature of the heat sink is around 56°C. The temperature difference between the chipboard and the heat sink is only 2 degrees. It shows how well the ALT heat dissipation system works.

"Since ALT is dedicated to providing the highest lumen and best quality replacement lamps to our customers, we are very excited about launching our latest Aurora™ series V5 MR16 and Apollo™ series BR40 lamps onto the market," stated James Liang. "By satisfying market demands, our new products have generated tremendous attention from the market. Moreover, because we have acquired several safety certificates, such as UL, FCC, CE, TUV, and the Laser Test, we can guarantee that our products can satisfy all of our customer's demands." ■

TESS Unveils a New Dimmable LED Bulb Dimming to 5 Percent

TESS (topco energy saving system corp.), a leading LED lighting developer and manufacturer in Taiwan, presents a new dimmable LED bulb to the market. This dimmable LED bulb can be steadily dimmed from 5% (the lowest brightness level) to 100% (the highest).



The TESS dimmable LED bulb can be dimmed to 5% and provides 810 initial lumens.

TESS's new dimmable LED bulb utilizes CREE XP-G LEDs, consumes 12 watts of electricity and delivers 810 lumens output, which is equal to an 80 watt incandescent bulb. In addition, the dimmable LED bulb provides warm white light and boasts a life-time of more than 10,000 hours.

The dimming capacity of most similar dimmable LED bulbs found on the market is from 20% to 100% output, yet the TESS dimmable LED bulb can bring the lowest brightness level down to 5 percent. The secret lies in its unique circuit design.

"Development technology is absolutely key for manufacturing a product with such good performance," said the chairman of TESS, Sunny Tsai. "It is not a problem for competitors to get hold of similar or the same components as TESS has. They can take our new products apart but they still won't be able to bring the dimming capacity down to a new level. It isn't only the development technology that is needed to push functions beyond their limits, but you also need experience."

Another crucial feature that makes TESS's dimmable LED bulb stand out among many similar products is the fact that it runs smoothly and doesn't flicker or buzz like some other products do. You can use TESS dimmable LED bulbs to create a cozy and intimate atmosphere at home, or use them for any occasion and you will see that you simply don't need as much light anymore. Power consumption decreases as the light dims and LED bulbs use less energy compared to CFLs and incandescent bulbs with the same or similar luminary efficiency. ■

Jincos: Eco×Smart+Green LED Replacement Bulb with Wide Dimming Range

Jincos LED lighting bulb series products provides a wide dimming range from 2% to 100%, in contrast to most other dimmable bulbs on the market which only support 5% to 100%. A lot of effort was necessary for the Jincos RD team to bring the lowest brightness level down to 2%.



Jincos Eco×Smart+Green LED replacement bulb provides extraordinary wide dimming rang.

Jincos 9W E26/E27 Dimmable LED Bulb Specifications:

- Wide dimming range from 2%~100%
- No visible or electronic flicker
- Resonant control to achieve high efficiency, 85%
- Meets the harmonic requirements and high power factor of 0.9 without dimmer
- LED luminous flux: 600 lm
- Color temperature: 3,000 K / 6,500 K
- Color index (CRI) 86
- Beam angle >250°
- Design life time: 50,000 hours
- Certifications: FCC/CE/ROHS

The main product of Jincos are the LED bulb, the LED down light, the LED T8 Tube and the LED Exit Signs. Jincos have FCC/CE/ROHS/CNS certificates. ■

Osram Claims the First Full 60 Watt Replacement LED Lamp on the Market

The Osram Parathom Classic A 60 with 12 Watt is the world's first LED lamp shaped like an incandescent lamp that fully replaces a conventional 60 Watt bulb – and at the same time cuts energy consumption by up to 90%. Innovatively designed, it is infinitely dimmable and has an average lamp life of 25,000 hours.



The Parathom Classic A 60 fully replaces a conventional 60 Watt bulb and cuts energy consumption by up to 90 percent at the same time.

Energy efficiency can also look good, as the Osram Parathom Classic A impressively proves. It not only fully replaces a conventional 60 Watt bulb but also looks much better, not to mention its true inner values, such as a power consumption of just 12 Watt, a light output of 640 lumen, a lamp life of up to 25,000 hours, energy efficiency class A and infinite dimmability. The lamp is compact and unbreakable, too, making it ideal for all conceivable uses around the home as well as in offices and hotels. And it is the first of its kind. "The Parathom Classic

LUMEN EFFICIENT DEVICE

The "Solar Tree" is a collaboration of Artemide and Sharp designed by Ross Lovegrove.

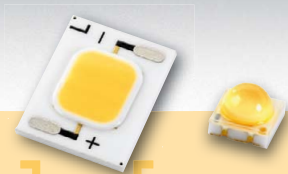

[IC]

[OPTO]

[LED]

[LCD]

[RF]

Sharp has redefined LED: Lumen Efficient Device. With its latest LED portfolio, Sharp offers lighting designers and product developers a complete range for innovative and energy-saving LED applications. Particularly suited for outdoor use, these decorative and functional lighting solutions are ideal for buildings such as airports, railway stations, museums and car parks, or as pioneering street lighting. Both indoors and outdoors – Sharp LEDs are impressive due to their quality, very high colour rendering and

light intensity. Available in colour temperatures from warm to cool white and in compact package sizes for greater design freedom. Take advantage of more than 40 years of LED experience. You can rely on the quality and efficiency of Sharp LEDs.

Our service team has samples on hand and would be pleased to advise you.

E-mail: info.sme@sharp.eu; Phone: +49 (0)180 507 35 07

 **electronica 2010**
components | systems | applications

Visit us at the electronica, 9-12 November 2010,
Hall A5, Booth A5.159 and A5.260 at RUTRONIK.

SHARP

| Microelectronics

A 60 from Osram is the perfect energy-efficient alternative to 60 watt bulbs," explains Christian Schraft, Head of Consumer Lighting at Osram. The new Parathom Classic A 80 with an even brighter luminous flux of 806 lumen will also be launched in autumn.

In addition to products directly replacing the conventional bulbs with screw base, the Parathom product family from OSRAM also includes LED lamps to replace halogen lamps rated at up to 50 W with all the commonest bases. Even today, these lamps are an appropriate alternative for ceiling lamps, spotlights and highlights both at home and in professional applications.

The Parathom Deco series, on the other hand, add a touch of color. With their bright range of blue, green, red and yellow color or as a color-changing version, these LED lamps create exactly the right mood for parties, in the living room or for the next garden barbecue.

All Osram Parathom lamps have one thing in common: they require up to 90 percent less energy than conventional bulbs and do not contain any mercury whatsoever. Their light does not contain any UV or infrared rays. Since the lamp uses an electronic control gear, it must be disposed of professionally and free of charge via a recycling station at the end of its useful life. ■

Comfortable Light with the New 10 Watt LED Lamp Produced by LEDON Lamp

LEDON LED retrofit lamps emit warm-white light and create a homely atmosphere. Therefore, they are the perfect replacement for light bulbs, not only in terms of design but also in terms of light quality. At the same time, LED lamps use up to six times less energy than incandescent lamps.



The warm white 60W equivalent 10W LED retrofit bulb saves about 83 percent of energy costs.

Unlike CFL energy-saving lamps, LED lamps have a continuous light spectrum, are free of toxic mercury and achieve 100% luminosity immediately after switching on.

Due to its unbeatable efficiency, the 10 W LED lamp produced by the Austrian company LEDON Lamp is definitely the new highlight in the LEDON product range. Its light output of 600 lumen and its great light quality ensure that it is the technologically leading LED lamp in this category. Furthermore, the lamp has a very elegant design: a white metal housing crowned by a frosted glass dome.

As opposed to conventional light sources the 10 watt LED lamp saves about 83 percent of energy costs. At the same time, this LED lamp has a warm-white colour temperature of 2,700 Kelvin. The new LED lamp with either B22 or E27 socket will be available as dimmable and non-dimmable versions as well as with a brand-new feature – the double-click option. By double-clicking your light switch, the LED lamp is dimmed down to 30% of its original brightness. By switching the lights on, briefly switching them off and switching them on again – the double-click – consumers will be able to create a homely atmosphere without using expensive dimmers. ■

ColorStars Group Launches the Dimmable R4-MR16-WHT Series MR16 LED Lamps

The 6W R4-MR16-WHT Series of retrofit LED lamps with a GU5.3 bi-pin base represent a milestone for the ColorStars' Group. The R4-MR16-WHT Series features a new heatsink that allows for the highest lumen output yet of any retrofit MR16 LED lamp manufactured by the ColorStars' Group. They are the first lamps to offer a dimmable function with linear AC transformers and some compatible electronic transformers.



MR16 LED lamp with new heatsink design allows for higher power rating and lumen output.

Four chips are used in the 6-watt lamps. They provide a lumen output that varies depending on the lens and beam angle, reaching 350 lumens $\pm 10\%$ for the R4-MR16-WHT-D-45.

Four beam angles are available in either daylight white (5,500 K ± 200 K) or warm-white (2,700 K ± 200 K or 3,000 K ± 200 K): 30°, 45°, 50° and 55°.

The R4-MR16-WHT series are dimmable with linear AC transformers, some compatible electronic transformers and standard TRIAC dimmers.

The power supply voltage of the R4-MR16-WHT series is 12~18 Vac and 12~24Vdc. The power supply current is <500 mA. Power consumption is 6 watts. Operating life is projected as 70% lumen maintenance after 35,000 hours. The lamp dimensions are: length – 38 mm and diameter – 49.5 mm.

Specific models, their beam angles and lumen output are as follows:

- R4-MR16-WHT-W-L-55 (lens) (3,000 K ± 200 K; 55° and 235 lumens $\pm 10\%$)
- R4-MR16-WHT-W-50 (3,000 K ± 200 K; 50° and 245 lumens $\pm 10\%$)
- R4-MR16-WHT-D-L-55 (lens) (5,500 K ± 200 K; 55° and 245 lumens $\pm 10\%$)
- R4-MR16-WHT-D-50 (5,500 K ± 200 K; 50° and 260 lumens $\pm 10\%$)
- R4-MR16-WHT-W-30 (2,700 K ± 200 K; 30° and 320 lumens $\pm 10\%$)
- R4-MR16-WHT-W-45 (2,700 K ± 200 K; 45° and 300 lumens $\pm 10\%$)
- R4-MR16-WHT-D-30 (5,500 K ± 200 K; 30° and 350 lumens $\pm 10\%$)
- R4-MR16-WHT-D-45 (5,500 K ± 200 K; 45° and 330 lumens $\pm 10\%$)

The ColorStars Group is headquartered in Irvine, California, U.S.A. with manufacturing facilities in Taiwan. ■

Nexxus Lighting Unveils 2nd Generation Array LED Replacement Lamps

Nexxus Lighting, Inc. announced the production of its 2nd generation Array™ Lighting line of products. In addition to its new Par 38, the Gen2 R30 and R16 are now available to order in an expanded color temperature offering (adding 2,700 Kelvin) and improved color rendering indexes exceeding 80 CRI.

Both of the new Gen2 product lines are UL listed, can be ordered in either architectural white or custom black housings and will feature the new Lighting Facts label on the packaging, which is sponsored by the U.S. Department of Energy (DOE) to assure the consistency of information about LED lighting products

Third party LM-79 testing has already been completed for the new Gen2 R30 and those reports, along with required IES files and LM-80 test data on the LEDs, can now be downloaded from the Nexxus Lighting website.



The Nexxus LED Array™ PAR lamp.

Nexxus Lighting is an ENERGY STAR Partner and the 2,700 K and 3,000 K Gen2 line of R30 and R16 LED replacement lamps has been designed and tested to meet the new ENERGY STAR Program Requirements for Integral LED lamps.

Nexxus has also added a GU24 base to its R30 and Par38 offering. This enhancement is designed for retrofit applications where energy conservation measures and incentives are tied to eliminating the ability to screw in a less efficient medium base lamp in the future.

"As a company focused on providing the highest quality, specification grade LED replacement lamps in the industry, we are very excited about rolling out our 2nd Generation designs to the commercial lighting market," stated Mike Bauer, President and CEO of Nexxus Lighting. "By exceeding performance expectations, our products have generated tremendous feedback from the market. By making third party testing and data available, including LM-79, LM-80, IES files and Lighting Facts Labels on new products, customers can be assured they are getting the quality products they expect from Nexxus Lighting." ■

Cooper Lighting Introduces Recessed LED Indirect Luminaire

Cooper Lighting has introduced the io® lili, a 2' x 2' recessed LED indirect luminaire designed to replace comparable fluorescent alternatives for general lighting applications. Featuring a unique patent pending organic reflector design, the indirect luminaire provides soft, glare-free illumination without excessive brightness and produces optimum light levels that are compliant with IES standards. The lighting fixture is an ideal solution for commercial offices, educational environments, and institutional facilities including hospital corridors and patient rooms, as well as other areas desiring comfortable low brightness illumination.



The io® lili, a 2' x 2' recessed LED indirect luminaire, can replace FL products perfectly. Cooper Lighting's unique reflector design provides optimum light levels with glare-free illumination for general lighting applications.

The luminaire's patent pending design features LEDs that are centrally located in a very low profile decorative pendant (light engine), which also serves as the heat sink providing required thermal management. The LEDs are optically controlled to project light up into the organically shaped reflector. The result is low surface brightness—much lower than other recessed indirect luminaires in its class and almost half the brightness of LED competitive troffer-type products.

The luminaire produces a bright white color temperature of 3,500K and features excellent color rendering (>80 CRI). It can be dimmed to 5% and has a projected average rated life of 50,000 hours at 70% of lamp lumen output, which is two times the life of comparable fluorescent sources. ■

WAC Lighting; LEDme™ Quick Connect™ Socket Sets to Integrate SSL Technology

Transforming more than 40 popular glass pendants into energy efficient fixtures, WAC Lighting unveils LEDme™ Quick Connect Socket Sets utilizing the latest LED technology.



The socket sets are constructed of aluminum with an acrylic diffuser and finished in Brushed Nickel, Chrome or Dark Bronze. Different shades are available, covering every style.

New LEDme™ Quick Connect Socket Sets transform art glass pendant designs from its 500 Series into LED fixtures. Some of the many popular designs include: Fiore, Komal, Brulee, Sarah and Hani, as well as the new pendants-- Micha and Rhea. Utilizing the socket sets, Quick Connect™ pendants can be mounted to WAC Lighting's SOLORAIL (single circuit low voltage monorail system), DUORAIL™ (two circuit low voltage rail system), or surface mounted with a canopy.

Quick Connect™ pendants, using the LEDme™ Socket Sets, can be dimmed with an Electronic Low Voltage dimmer from 100% to 15% or better.

For optimal performance and color consistency, WAC uses ANSI (American National Standards Institute) Compliant Warm and Neutral LED Bins from leading LED suppliers. Each LED saves energy, relamping costs and maintenance, while offering a 30,000-hour potential life. Each socket set uses five watts and delivers a light output of 230 lumens, with a color temperature of 3,500 K. ■

Future's Engineering Support & Creative Technology Hong Kong Develop LED Downlights

Future Lighting Solutions joint development project with Creative Technology Hong Kong Limited yielded a new line of solid state downlights manufactured under Creative Technology's Mabushi brand. The luminaires utilize LUXEON® Rebel LEDs and were designed with thermal, electrical and optical support from Future's engineering team.

With Future's assistance, Creative selected LUXEON Rebel LEDs for their industry-leading reliability and 50,000-hour useful life. Future also aided in driver selection and overall system design, using proprietary tools to accelerate and optimize LED system development including maximizing LED output and lifetime.



Creative Technology's Mabushi brand luminaires were jointly developed with Future Lighting Solutions and utilize LUXEON® Rebel LEDs.

Imagine...

the Worlds Brightest 0.5W SMT LED

Your Imagination: A low power, high brightness, optimal flux, wide viewing angle, low thermal resistance, MSL2 rated, PLCC-4 SMT LED.

Our Innovation: Avago Technologies delivers the Worlds BRIGHTEST 0.5W PLCC-4 SMT LED designed to optimize your products for backlighting, auto illumination, decorative lighting, cabin lighting and other applications.

- Low thermal resistance 40°C/W
- Super wide 120° viewing angle
- Longer life time with minimum degradation due to enhanced silicone resin material
- JEDEC MSL 2
- Available in Cool White, Warm White, Blue, Green, Red, Red-Orange & Amber colors

If a commitment to technical excellence and success in illumination technologies is critical to your new designs – Contact us at: www.avagoresponsecenter.com/469



AVAGO
TECHNOLOGIES

Your Imagination, Our Innovation

Kingbright's KPHB-1608 series Bi-colour SMD-LED im 0603 package

Features:

Dimensions = 1,6 mm x 0,8 mm x 0,5 mm

Available in various colour combinations

Luminous intensity up to 230 mcd @ 20mA

By the low construction height this bi-colour SMD-LED is suited especially for backlighting at Keypads, Keyboards or LCD's

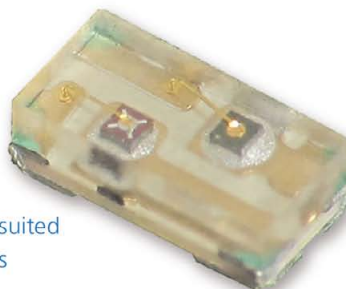

electronica 2010
components | systems | applications

09. - 12. November
Please visit us in hall A5, stand A5-275

Quality — Efficiency — Innovation — First-class service

Kingbright Electronic Europe GmbH • Lindenau 7 / Gewerbegebiet • D-47661 Issum • Phone: +49 (28 35) 44 46-0 • Fax: +49 (28 35) 44 46-29

The collaboration resulted in 23 downlight models that are being distributed in 10 countries throughout Asia and Europe.

"We have a sister company that has been manufacturing LED flashlights since 2000, but the Mabushi line is our first solid state general lighting. For that reason, we relied heavily on Future's engineers in designing the LED assembly," said Kenneth Yang, Managing Director of Creative Technology. "Their tools and expertise helped speed our time to market as well as deliver a high-performance product." ■

ACDC's New Range of Downlights Offer Massive Savings on Energy

With two brand new additions to the award-winning LED downlight range, again boasting industry-leading performance and design, ACDC now offers one of the most comprehensive selections of halogen replacement luminaires available.

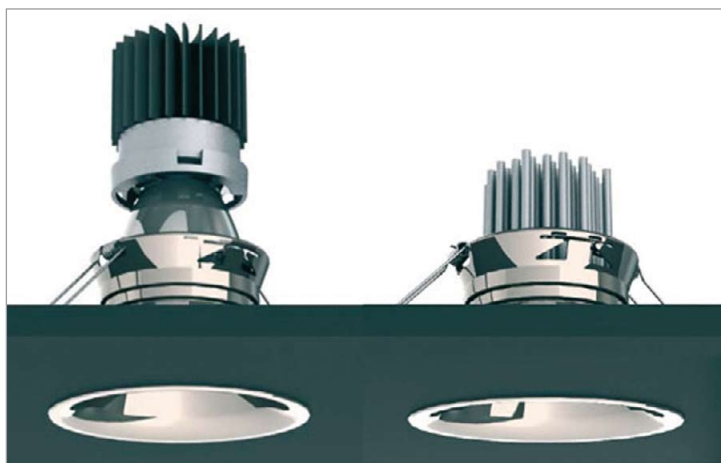

ACDC's Storm is a fixed downlight with 35 Watt halogen output.

Complex heat sink structures dissipate the heat away from the LED, with the Evolution range utilising revolutionary thermo dynamic technology and liquid cooling, to maintaining the product lifetime and performance. The whole range delivers 50,000 hour lifetime to 70% lumen maintenance, and this along with the energy saving benefits of the product enables a 2 year payback on total cost of ownership, when compared to halogen equivalents.

The product ranges includes a range of low glare technical architectural LED downlights include Storm, a fixed downlight with 35 Watt halogen output and the Hurricane family, with either 35 or 50 Watt halogen equivalent, fixed or adjustable downlight with lockable tilt and rotate mechanism. ACDC's acclaimed Devil Engine is at the heart of each luminaire with a choice of 4 interchangeable optics, although the Xicato LED engine can also be specified for a fixed 40 degree beam. These products also feature a clever pivot mechanism, which delivers all the light from the luminaire, even when fully adjusted and, along with the ultra efficient optics, deliver significantly better performance than any other downlights available. ■

PLEXIGLAS® Textured Sheet RADIANT

PLEXIGLAS® Textured Sheet RADIANT, the new product that Evonik is set to offer from September, is guaranteed to grab attention. For one thing, its textured surface diffuses light in an interesting way. For another, it creates colors that change according to the viewing angle, which is known as the RADIANT effect. Passersby see a colorful play of hues that is set off to particular advantage by the surface texture.

- PLEXIGLAS® Textured Sheet RADIANT: new eye-catching combination of a textured surface with a rainbow effect
- Applications in store fixtures and exhibition booths, futuristic design in bars, lounges and lighting elements
- Sheets available with a honeycomb, ribbed or pyramid texture



Luminaires expose a firework of colors with PLEXIGLAS® Textured Sheet RADIANT.

The special RADIANT surface coating is available on three different textures: Honeycomb, Ribbed and Pyramid. The combination of texture and color effects makes PLEXIGLAS® Textured Sheet RADIANT the center of attention, and equip the material for all applications that are meant to catch the eye, such as store fixtures and exhibition booths.

PLEXIGLAS® Textured Sheet RADIANT also offers a diversity of options for interior design in bars, clubs and lounges. Designers and creative professionals make use of the material's mirror-like reflections and scintillating colors. Lighting elements made from this new material in ceilings and floors, or in lamps, are particularly striking.

Ordinary daylight is usually enough to trigger the impressive rainbow effect, but the firework of colors is emphasized when PLEXIGLAS® Textured Sheet RADIANT is illuminated or backlit. Depending on the focus of the light source, this gives rise to a myriad of different shades.

This rainbow, or RADIANT effect, is very popular. The existing PLEXIGLAS® RADIANT grade has already been installed in a large number of applications. The new product that has now been further developed by the Acrylic Polymers Business Line at Evonik builds on this success. ■

RECOM Launches Ultra Compact "LightLine" AC Input LED Drivers

After the success of its pioneering DC LED driver modules, RECOM has developed a new series of constant current LED drivers with universal AC inputs, power factor correction and UL certification.

The first two products in the "all inclusive" RACD series are a 12 W and a 20 W solution to meet the needs of the high brightness LED lighting market. With universal AC input and constant current output of 350 mA or 700 mA, the RECOM AC input LED driver modules are suitable for driving almost any LED manufacturer's products and almost all LEDs

systems in the industry as they have a very wide output voltage range over which the constant current regulation works. They can be used with single LEDs or with strings of up to 16 LEDs.



RECOM designed a new "LightLine" and "Ultra Compact" 60 Watt open frame AC Input LED driver series with some outstanding features.

Both the RACD12 and RACD20 also feature built-in >0.95 power factor correction, 3 kV AC input/output isolation, a fused input. The converters are certified to the new UL8750 standard for driving LED arrays.

The drivers are designed to be simple to use without an extensive knowledge of electronics and offer both input and output screw terminals and an additional 5.5 mm socket output. The socket allows the LEDs to be pre-wired with a matching plug to avoid possible mis-wiring and make lighting installation easier and safer.

With over 70,000 hours of operating life, the RECOM RACD12 and RACD20 series are ideal for commercial, residential and industrial SSL.

In addition RECOM has added a new series of 60 Watt open frame AC input LED drivers to its range of "LightLine" constant current LED drivers. The new products are approx. half the size of their competitors.

The RACD60-Series offers a wide range of output currents and is available in five different versions to meet the current needs of any lighting system from 700 mA up to 4.2 Amps. The output current can be adjusted with an internal potentiometer to match any non-standard requirements.

With efficiencies up to 89% and built-in >0.9 power factor correction, the RACD60 is one of the most cost effective switching power LED driver modules in the market. The high efficiency permits an ambient operating temperature range of -25°C to $+60^{\circ}\text{C}$ without de-rating.

The module is designed to meet the European EMC and Harmonics regulations, EN55015 and EN61547 and EN61000-3-2 and -3, as well as the US safety regulations UL60950. UL8750 certification is pending.

With an outstanding compact package of 4"x2.1", RECOM has developed one of the smallest 60 Watt LED drivers in the lighting industry and it's suitable for almost any industrial, commercial or residential lighting system.

The new products are fully protected against short circuit, open circuit, overload and over temperature, all of which guarantee a robust, trouble-free and safe design. ■

ARC Solid-State Lighting: 12-Channel LED Mini Controller with RF Module

ARC3004-W is the mini controller designed for the LED advertising and indoor commercial lighting which you can adjust for the atmospheric and decorative lighting. Integrating the control and driving capabilities, it enables connection of the lighting fixture via PWM signal without a driver which can be an LED single color or RGB full color fixture. In addition to the built in 12-channel of ARC3004-W, it is extremely scalable and able to support up to 32 sets of the controller connecting. It is also optional in accordance with the ARC extension module while using the high power fixtures.



The ARC3004-W mini controller offers an integrated RF module and advanced control and driving capabilities.

Application:

- Commercial shop lighting
- Outdoor advertising signage
- LED ambient atmosphere & decorative lighting

Specification:

Items	Specifications
Supply Voltage	DC 12 - 40 V (type 1); DC 25 - 48 V (type 2)
Channel	12 channels
Output signal	LED 1-12 channel, PWM
Maximum Driving Current	Per channel maximum 2 A, Total maximum 24 A
PWM Frequency	Standard Mode: 1 kHz High Power Mode: 180 Hz
Memory	1 M byte
Adjustable Gray Scale	Built-in Gamma correction technology, select 256 gray scale from 12bits 4096 gray scale
Lighting Effect	8 built-in and 8 user-defined (the latter should be edited through Lightshow software and downloaded by RS485 interface).
Synchronization	32 sets (RS485)
Operation Temperature	-20°C - 60°C
Operation Humidity	20% - 90% RH
Waterproof	IP66
Dimensions	(L)141 mm x (W)50 mm x (H)29 mm
Certification	CE/FCC

It is simple to adjust the ARC3004-W program, speed, and brightness in any situation to accommodate entertaining with the unique software and RF module. Furthermore, color 4096 grey scales with the function of gamma correction technology, make the color more clear and smooth. In order to meet operation requirements for convenience and efficiency for the user, it allows memorizing of the selected program until it is rebooted. The 16-program lighting effect, 16-segment speed and the 8-set for brightness are also adjustable in accordance with the RF module. The ARC3004-W, with its various functions, can be applied in a variety of applications, such as LED advertising signage, commercial shop and indoor decorative lighting. ■

e:cue Lighting Control Introduces Light-Drive Elite - Innovative DMX Controller

e:cue lighting control – An OSRAM Company, introduces Light-Drive Elite, its first standalone DMX controller and user interface for dynamic RGB LED lighting that does not require software programming.

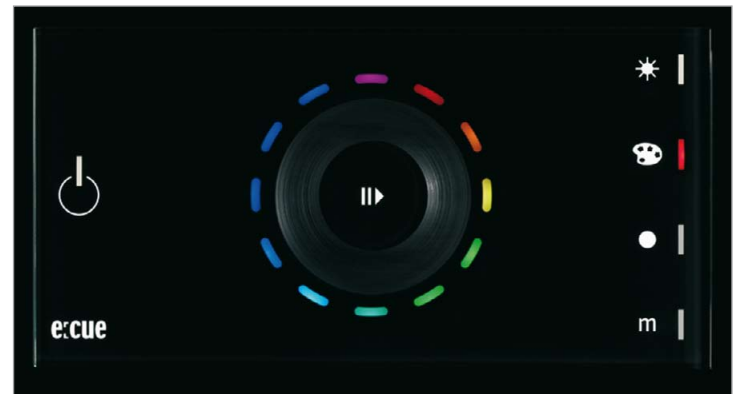

The e:cue Light-Drive Elite is an innovative DMX controller with an elegant touch of simplicity.

Users can easily control intensity, color, and speed as well as setup their favorite color-changing effects through Light-Drive Elite's glass interface with touch-sensitive keys and touch wheel.

Specifically designed for the end-user, this innovative DMX controller features a high-end sleek design and an intuitive interface that allows anyone to create static and dynamic lighting scenes. Jan Julius Miebach, e:cue's Managing Director for Product Strategy, said "we designed this product to allow end-users to experience dynamic lighting as well as create dynamic lighting scenes themselves. We specifically paid a lot of attention to the user interaction with the device as well its aesthetic design."

The glassy interface features an LED ring around the touch wheel to guide users in selecting and adjusting colors, intensity and speed as well as select four colors for graceful color-changing lighting scenes.

Powering the light of tomorrow

LightLine. The next generation of constant current LED drivers

✓ High Power AC input LED Driver

The RACD60 series - a high power AC input LED driver module. Designed to meet the requirements of the newest and brightest LEDs on the market. Output current from 700mA up to 4.2A, this series can drive almost any LED in the market. One of the smallest 60Watt AC LED driver in the industry.

✓ Low Power AC input LED Driver

Introducing the RACD series low power AC input LED driver. A low cost solution to the low power Solid State Lighting. This family includes of 3W, 6W, 12W and 20W modules with different configurations capable of driving up to 15 high brightness LEDs.

✓ DC input LED Driver

The RCD-24 family offers DC input LED driver modules with constant current output from 300mA up to 1.2A, high efficiency (up to 97%), wide input voltage range (5~36Vin), very low output dropout voltage, 2 independent dimming options (PWM and 0-10 analog) and a long lifetime up to 600,000 hrs.

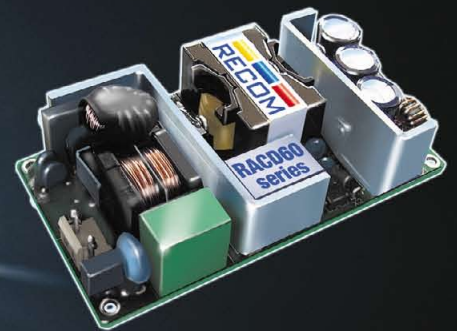

RECOM

www.recom-electronic.com

 **electronica 2010**
components | systems | applications
RECOM Fair Booth: B2.213

Light-Drive Elite does not require software to program it at all and it is easily connected to fixtures through an RJ45 connection for power and data, outputting directly DMX.

The four mode keys are used to select Intensity, Color, White color temperature, and Memory to store the four user-modifiable colors.

The package also includes a power and data merger to simplify the connection to the light-drive elite.

The product is designed for wall-mounting and it is easily mounted using the bracket included in the package. The sleek shape without push-buttons is designed for protection and easy cleaning. Light-drive elite features a cleaning mode: By holding the on/off key for five seconds, it allows easy cleaning of the glassy interface without affecting the touch keys or the touch wheel.

An optional remote control device is available used with the device's IR receiver. Light-Drive Elite can also work with fixtures that are driven by PWM or DALI using e:cue's dmx2pwm and dmx2dali interfaces. ■

Phihong Adds LED Drivers to Power Supply Products

Phihong, a global leader in power solutions, has developed an LED driver capable of supplying 90W of power for use in indoor lighting. Designated the PSM090-240P, the power supply's open-frame design allows for ease of integration into interior lighting designs.

"The addition of LED drivers was a natural progression to our lighting ballast business," said Keith Hopwood, vice president of marketing for Phihong USA. "As customers are becoming more environmentally conscious and economically savvy, the switch from traditional fluorescent lighting and ballasts to LED lighting systems is much more efficient and environmentally friendly over the long run without sacrificing lumen output."



The power supply's open-frame design allows for ease of integration into interior lighting designs.

The device is available in a constant current of 3.75 A with an output DC voltage range of 22.8 ~ 25.2 and is designed for any input line from input voltage range of 100V to 277VAC.

The PSM090-240P is intended for use with architectural, street light and HID replacement applications. Its design also allows for ease of integration into custom LED lighting arrays.

The 90 W LED driver features power factor correction allowing for a PF of 0.95 minimum at 115 VAC input and a minimum of 0.90 at 277 VAC input. The efficiency for the series is rated at a minimum of 85% and may operate within a range of -10°C to 40°C.

The series also has overload, over-voltage, over-temperature and short-circuit protection and is compliant with the UL8750 standard. The PSM090-240P measures 6.65x2.4x1.22 inches and weighs 13 ounces. ■

D-LED Offers Two Brand New Highly Efficient DMX LED Drivers

D-LED now offers DIN-rail mountable solutions of flicker free, dual current, DMX LED Drivers. These new products promise to be the most versatile and cost effective featuring the latest technology available.



Flicker free, dual current DMX LED drivers for DIN-rail mounting.

DR-SD12 and DR-SD6 are multiple current source solutions. The DR-SD12 caters to LED lighting applications of up to 435 W (12x12 3-W LEDs), up to 12 channels, while the DR-SD6 caters to LED lighting applications of up to 172 W (6x12 3-W LEDs), and up to 6 channels.

Features:

- DMX-512 addressing
- 50mA – 700mA driving current
- Smooth fade control with continuous current output
- High efficiency (up to 95%)
- From 1 and up to 12 LEDs per channels
- LCD display and menu navigation keys
- Self diagnostic protocol
- Line and circuit protections
- Thermal protection
- Easy profile and installation

Applications:

- Architectural use
- LED lighting effects
- Theatrical and studio lighting
- Commercial and retail

Both, the DR-SD6 and the DR-SD12 are DMX-512 controllable and allow the flexibility needed in driving your high brightness LED's. ■

Cree Demonstrates High Quality 150-mm Silicon Carbide Substrates

Cree, Inc. announced that it has achieved a major breakthrough in the development and wide scale commercialization of silicon carbide (SiC) technology with the demonstration of high quality, 150 mm SiC substrates with micropipe densities of less than 10/cm². The current Cree standard for SiC substrates is 100 mm diameter material.

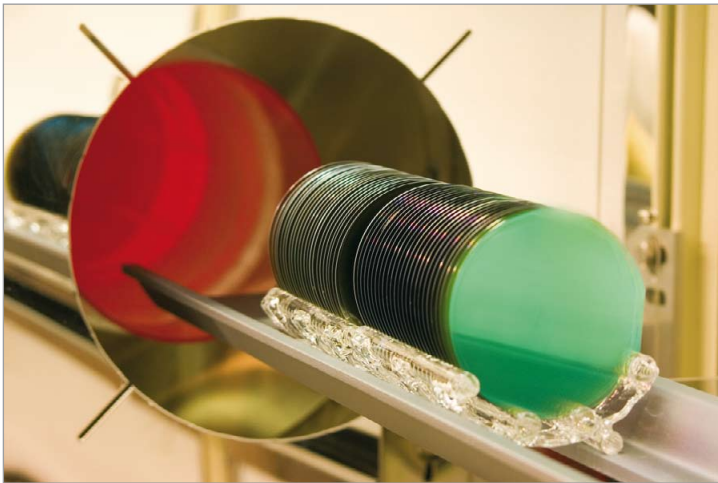

Cree's new SiC substrate allows twice the diameter of the shown batch of 3-inch-diameter SiC wafers.

SiC is a high-performance semiconductor material used in the production of a broad range of lighting, power and communication components, including light-emitting diodes (LEDs), power switching devices and RF power transistors for wireless communications. The significant size advancement of single crystal SiC substrates to 150 mm can enable cost reduction and increased throughput, while bolstering the continued growth of the SiC industry.

"Cree's achievement of 150 mm SiC substrates further demonstrates Cree's leadership in SiC materials technology," said Dr. Vijay Balakrishna, Cree Materials product line manager. Steve Kelley, Cree chief operating officer, added, "We expect that 150 mm substrates can reduce device cost, boost manufacturing output and expand our product range". ■

Low Cost LED Measurement Solutions

- Complete hardware & software systems to easily characterize LEDs, arrays, modules, and displays

- NIST Traceable measurements include:

- Watts/m
- µwatts/cm
- LUX
- xy chromaticity
- Lumen
- PAR
- Purity
- CRI & CQS
- CCT



www.StellarNet.us ContactUs@StellarNet.us (+)1 813.855.8687

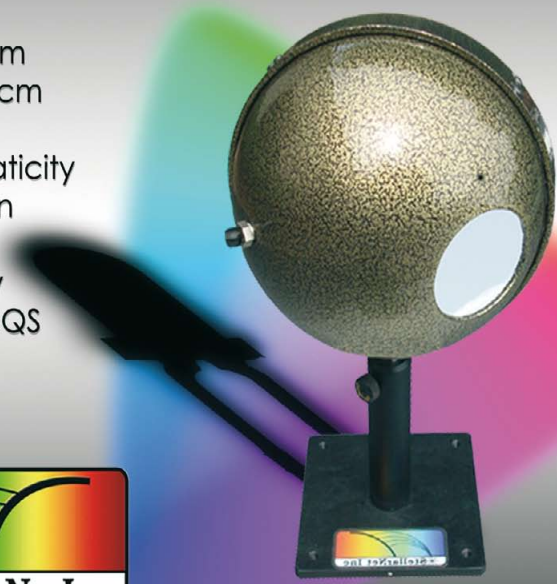

Labsphere's TOCS Conforms to LM-79 and LM-80

Labsphere's new Thermal/Optical/Electrical LED Measurement Systems (TOCS) enables measurement of optical properties as a function of temperature and operating current using a single instrument. The TOCS complies with IESNA LM-79 and LM-80 standards, delivering accurate and reproducible LED measurements.



Labsphere's TOCS system conforms to IESNA LM-79 and LM-80 recommendations for LED characterization.

Available in a range of integrating sphere sizes from 20 to 76 inches, the TOCS systems are designed for both 2pi and 4pi measurement geometries. A lamp measurement integrating sphere, high resolution CCD array spectrometer, thermal plate with temperature controller, auxiliary lamp, calibration source, power supply and Labsphere's powerful TOCS-SS software comprise the basic system. Owners of current Labsphere and SphereOptics spectral lamp measurement systems may purchase an upgrade retrofit to the TOCS system to achieve LM-79 and LM-80 compliance.

Labsphere's TOCS-SS is a powerful, accurate software which automates procedures for measuring spectral characteristics, and controlling current and temperature. Users control LED temperature and operating current at specified ranges, measuring and characterizing the device under test over a wide temperature range. The simultaneously collected electrical, optical and thermal data is graphed for quick on-screen viewing and can be exported to Excel format for in-depth analysis.

The TOCS can be customized with the integrating sphere size, calibration source and accessories to fit different testing needs. ■

Konica Minolta Releases New Hand-held Chroma Meter: The CL-200A

Konica Minolta Sensing, Inc. announces the introduction of the new lightweight portable chroma meter CL-200A suitable for measuring the color temperature of white LEDs and other Light sources. The CL-200A is the successor to the current CL-200 chroma meter.



The CL-200A is the successor to the current CL-200 chroma meter.

Konica Minolta chroma meters measure not only luminance but also color temperature and chromaticity at the same time.

The chroma meter CL-200A, which succeeds the current CL-200, has improved operability for white LED measurement. In addition to measuring the color temperature, chromaticity and luminance of light sources, the CL-200A also shows the dominant wavelength and excitation purity directly in the display. The CL-200A is a perfect tool to monitor the quality of new lighting devices such as LED modules. Furthermore, with the standard accessory software, which runs on a PC, users of the CA-200A will be able to rank each measured LED.

Increased operability for white LED and OLED measurements:

Many white LEDs are comprised of a blue LED, which is coated with yellow phosphor. The resulting white light in this case is actually a mixture of the yellow light emitted by the yellow phosphor coating and the blue light emitted by the blue LED. As the wavelength distribution of the blue LED emission spectrum differs from LED to LED, the white light generated also varies. Because of this, it is very important to control not just brightness but also color when white LEDs are measured. The CL-200A is a revolutionary tool to obtain all necessary indexes for monitoring white LED light in a single operation.

Remote measurement functionality:

Removal of the receptor head from the CL-200A main body and reconnecting using optional remote adapters allows for measurements to be taken with the receptor placed far away or in an isolated darkroom environment.

LED ranking function:

Measurement data can be transmitted from the CL-200A to the included software program. Using this software it is possible to display measurements on the chromaticity chart and classify each measurement easily by rank automatically and numerically by plotting the data on the chromaticity chart.

Konica Minolta chroma meters are well accepted and valued by R&D departments and production lines of LED manufacturers. The new CL-200A is useful not only for LED manufacturers but also for lighting designers, architects and engineers in the field. ■

Count On Tools Announces Expanded LED Nozzle Series

Count On Tools Inc., a leading provider of precision components and SMT spare parts, announces the expansion of its LED nozzle series. By working closely with the LED component manufacturers, Count On Tools guarantees secure picking of all fragile components and accurate placement on circuit boards.

Recent growth in LED technology and solid state lighting has provided the electronics manufacturing industry with viable solutions for today's electronics devices. As a result, companies in the surface mount technology (SMT) industry are expanding their manufacturing capabilities to meet this demand.

We bring quality to light.

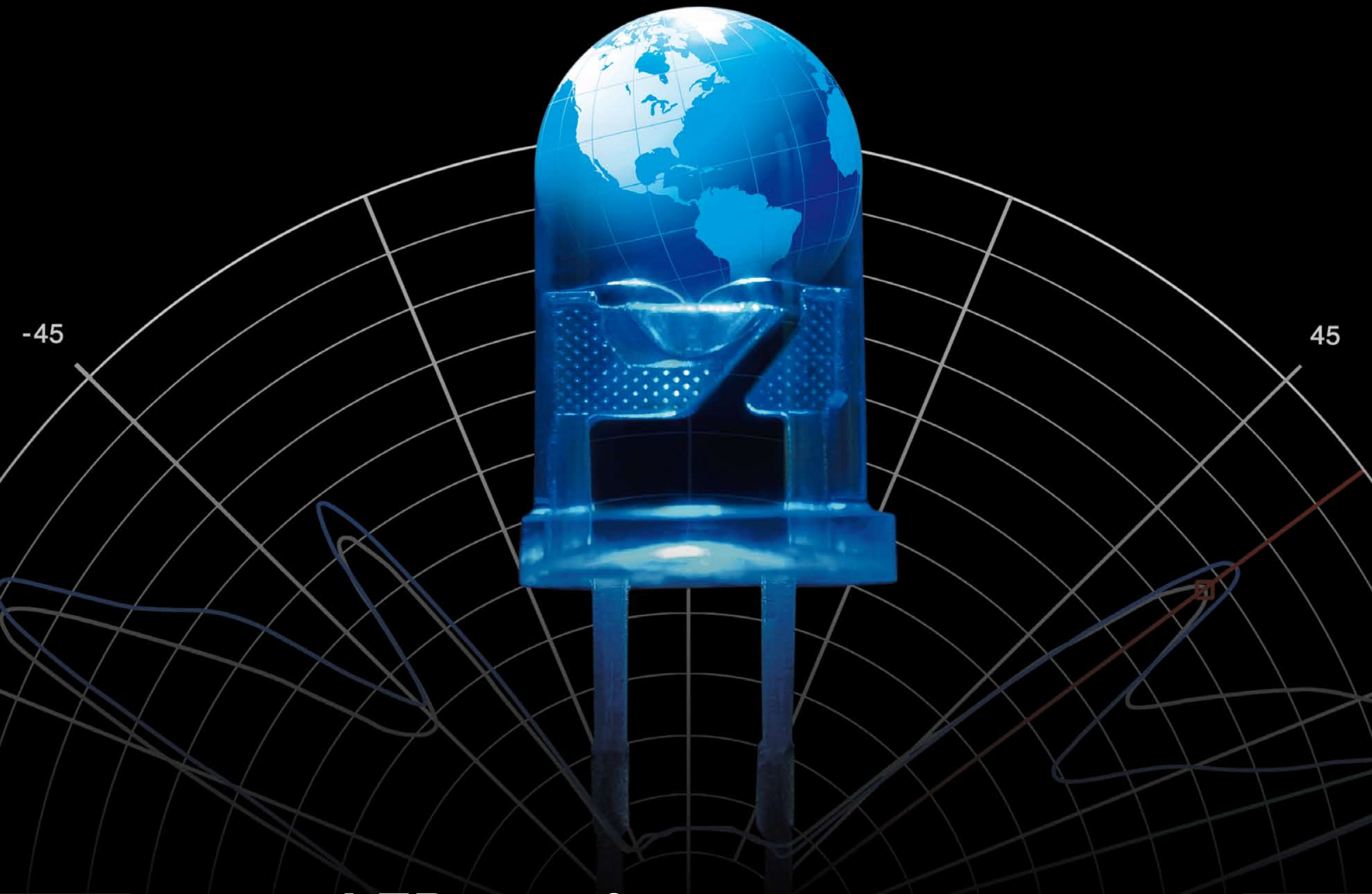

LED test & measurement solutions from the world leader

Instrument Systems continues to set the benchmark in LED metrology. Whether testing individual LEDs (standard or high-power), LED modules, or OLEDs - the global LED industry relies on us to engineer superior measurement equipment for high-speed production testing and high-performance R&D and QC applications.



Our instruments provide accurate and reliable results as per CIE recommendations and methods:

- Luminous flux [lm], luminous intensity [cd], and luminance [cd/m²]
- Chromaticity coordinates x,y,z and u'v'
- Color temperature and color rendering index
- Dominant wavelength and spectral data
- Spatial radiation pattern

 **Instrument
Systems**
light measurement



Count On Tools' LED nozzle series is available for all types of SMT pick-and-place equipment and tooling.

The range of new and potential applications for LEDs in electronics is practically endless. Count On Tools has realized this trend and developed a line of nozzle designs that will allow customers to accurately and consistently place LEDs with its existing SMT pick-and-place equipment.

The expanded offering of custom LED nozzles contains the following LED component suppliers: American Opto, CREE, Edison Opto, Lumileds (Philips), Luminus (PhlatLight), Luxion (Rebel), Nichia, Osram Opto, Sharp, Seoul Semiconductor (P4), and Vishay.

According to Curt Couch, President of Count On Tools, Inc., "Count On Tools understands that in order for our customers to remain competitive in today's market, they must be able to cut costs while simultaneously maximizing the capabilities of their SMT assembly equipment to prevent costly investments in new equipment or increased labor from hand placements of odd-form components. This line of custom LED nozzles allows us to help customers achieve better placement with odd-form components in their machines while saving them money." ■

EV Group: Industry's First Fully Automated Wafer Bonding System for HB-LED

EV Group (EVG), a leading supplier of wafer bonding and lithography equipment for the MEMS, nanotechnology and semiconductor markets, announced that it has introduced the EVG560HBL wafer bonder—the industry's first fully automated wafer bonding system for high-brightness light emitting diode (HB-LED) manufacturing.

The system features a new design for multi-substrate bonding and is capable of throughput rates of an unprecedented 160 bonds per hour. Based on the successful EVG500 wafer bonding series, the EVG560HBL is optimized to meet the unique requirements of HB-LED manufacturers with the advanced automation capabilities that they will need to increase their production capacity and yields.

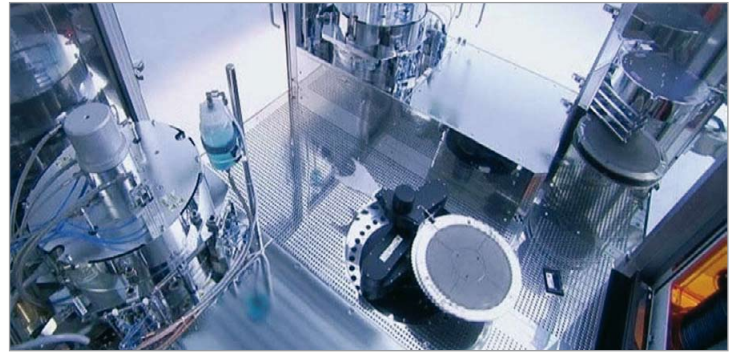

The EVG®560 HBL is a dedicated, fully automated wafer bonding system for High-Brightness LED manufacturing.

The EVG560HBL is a multi-substrate wafer bonder that offers a number of advanced capabilities to enable high-volume HB-LED manufacturing, including:

- High-force capability, in-situ low-force wedge compensation and proprietary compliant layer technologies—all to ensure bond uniformity across the entire wafer, which is essential for high-quality, multi-substrate bonding
- Integrated pre-processing modules for low-temperature metal wafer bonding, which enables higher throughput and provides less thermal stress on the wafer stack, which in turn increases yield
- Warped/bowed wafer handling capability for maneuvering thin and fragile substrates, which minimizes tool downtime and eliminates wafer breakage issues
- Unique bond chamber design, which enables customers to change out substrate sizes in less than 30 minutes, increasing tool flexibility and lifetime while enabling easy maintenance and maximized tool uptime
- Cassette-to-cassette operation
- Mechanical wafer-to-wafer alignment
- SECS II/GEM interface
- Wafer ID tracking for advanced process control

„The EVG560HBL is the latest result in our ongoing efforts aimed at helping HB-LED manufacturers develop more efficient, cost-effective and higher yielding devices to meet the demands of their customers,” stated Paul Lindner, executive technology director, EV Group. ■

Veeco: Precision Optical Profiler for Automated HB-LED Production QA/Q

At the SEMICON West trade shows and seminars in San Francisco, Veeco Instruments Inc., a leading global provider of precision instrumentation and metrology solutions for scientific and industrial markets, will announce a new ContourGT(TM) Optical Surface Profiler configuration optimized for characterizing high-brightness light-emitting diode (HB-LED) patterned sapphire substrates (PSS).

The ContourGT-X8 PSS combines advanced non-contact 3D measurement capabilities with unique Veeco PSS metrology hardware and software technology, and a Wafer Automation System Developer's Kit (SDK) that provides a tailored solution for PSS quality assurance and quality control applications where high-throughput and repeatability capabilities are essential.



ContourGT Profilers provide high-throughput, nondestructive measurements for PSS height and width, as well as substrate bow, thickness and roughness to improve yield and ensure LED efficiency and color consistency.

"The ContourGT-X8 PSS gives wafer suppliers and HB-LED device manufacturers an affordable way to obtain high-throughput, 3D surface metrology to enhance productivity, while assuring the quality of their end products." said Mark R. Munch, Ph.D., Executive Vice President, Veeco Metrology & Instrumentation

Ross Q. Smith, Vice President and General Manager, Veeco Optical Industrial Metrology, added, "We have worked closely with PSS wafer suppliers and HB-LED manufacturers to develop the ContourGT-X8 PSS, ensuring that it has the full breadth of capabilities necessary to deliver the required measurements. In addition, we have teamed up with leading wafer automation providers such as CHAD Industries to develop a compelling value proposition for HB-LED manufacturers who often need flexibility in automation solutions." ■

Lambda Research Releases TracePro 7.0, Optomechanical Design Software

TracePro 7.0 increases raytracing speed up to 10 times over the 6.0 version using new multi-threading algorithms. This release also features a new interactive optimizer, rearrangeable system tree, new Reptile™ geometries and irradiance options.

TracePro 7.0 uses multi-threaded algorithms to raytrace on all the cores in Intel or AMD multi-core CPUs. Simulations, done on a Dual Quad core computer, show raytracing improvement of up to 10 times over previous releases when simulating LED, lighting, display, biomedical and aerospace systems.

Your partner for
high-tech competence
in **energy efficiency**

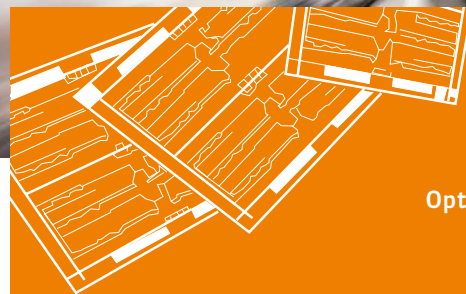

High thermal conductivity

Excellent for chip on board

Optimized heat spreading

DBC SUBSTRATE

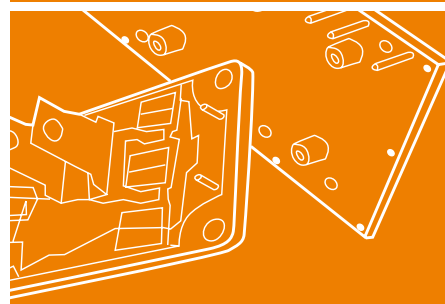

Highly integrated cooler

Outstanding thermal performance

Customized design

DBC COOLER



Optics | Development · Construction | Electronics

Your Project - Our Competences

- Optics
- Lighting Technology
- Mechanics
- Electronics
- Systemintegration
- Project Management

Optical Systems
lighting-oes.os@jenoptik.com
www.jenoptik.com/oes_lighting

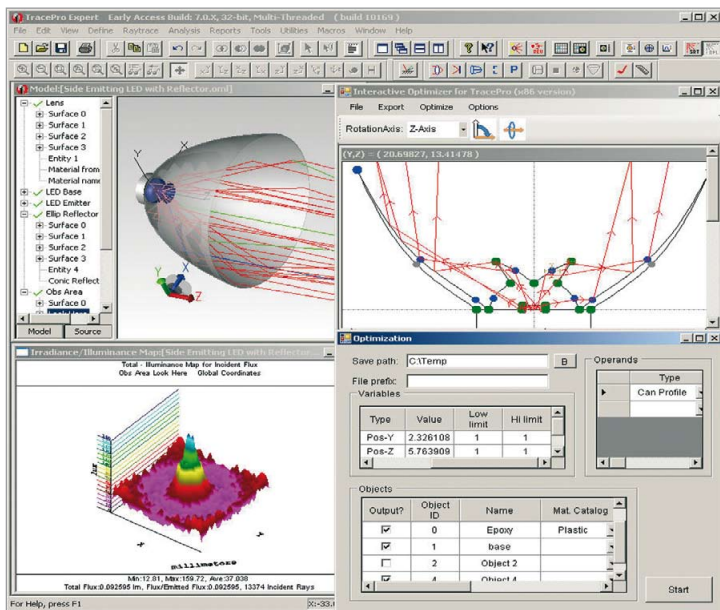
TracePro Expert Early Access build: 7430, 32-bit, Multi-Threaded (build 10164)
Model: [Side Emitting LED with Reflector.aml]
Interactive Optimizer for TracePro (alpha version)
Optimization window showing variables and operands.
Irradiance/illumination map for Incident Flux.

Compared to its predecessor, TracePro 7.0 has dramatically improved algorithms to speed up the workflow.

The new interactive optimizer is specifically designed for non-sequential design on LED and illumination systems. The optimizer features a sketch utility for quick design entry, interactive raytrace for design verification, downhill simplex optimizer with interactive entry of target specifications.

Other new features include a re-arrangeable system tree to create assemblies and standard drag and drop operations to arrange parts and assemblies. Two new irradiance options have been added including a new rainbow palette and normalization for stray light point source transmittance calculations. TracePro 7.0 also adds two new RepTile geometries, a flattened and pointed cone for the backlight display simulation. ■

National's WEBENCH LED Architect Simplifies and Speeds Up Lighting Design

National Semiconductor Corp. announced the addition of WEBENCH LED Architect to its award-winning portfolio of online WEBENCH® Designer tools. The first of its kind, WEBENCH LED Architect enables both novice and expert designers to perform real-time comparisons and optimize complex lighting systems for performance, size and cost in minutes.

To start a design, the designer enters desired light output (lumens) and adjusts the design with the unique WEBENCH Optimizer Dial, evaluating size, conversion efficiency and cost trade-offs. The designer can order components for prototyping, share the complete system with others, or easily print a complete project report including schematics, bill of materials (BOM) and performance characteristics.

"We are enabling creative designers to compare a hundred different topologies for a lighting system in a few minutes," said Phil Gibson, vice president of Technical Sales Tools at National Semiconductor. "WEBENCH LED Architect frees their imagination, so they can deliver brilliant lighting designs at the lowest possible cost."

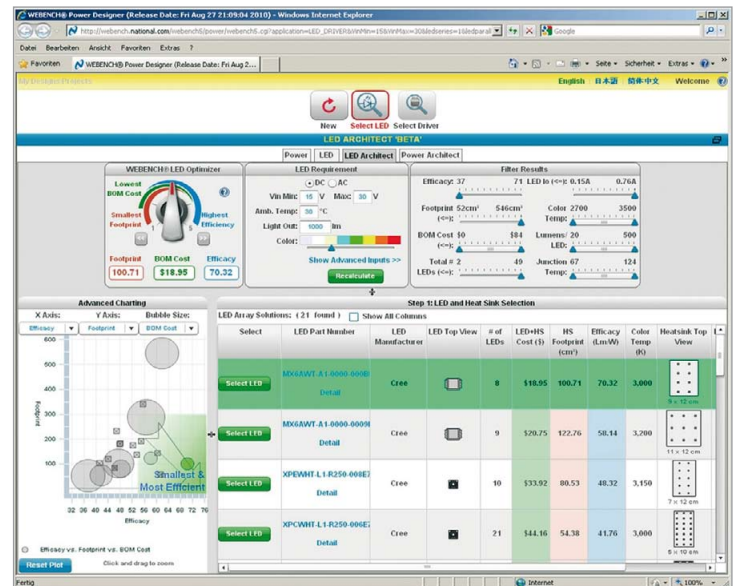

WEBENCH LED Architect interface showing optimization parameters and results table.

LED Part Number	LED Manufacturer	LED Top View	# of LEDs	LED-HS Cost (\$)	HS Footprint (cm²)	Efficacy (lm/W)	Color Temp (90)	HeatSink Top View
MX6AWT-A1-0000-000B	Cree		8	\$18.85	100.71	70.32	3,000	
MX6AWT-A1-0000-000H	Cree		9	\$20.75	122.76	58.14	3,200	
XP6AWT-L1-R250-000E	Cree		10	\$33.92	80.53	48.32	3,150	
XP6AWT-L1-R250-000E	Cree		21	\$44.16	54.38	41.76	3,000	

National's WEBENCH LED Architect simplifies and speeds lighting design.

WEBENCH LED Architect is a quick visual tool for complete lighting system design up to 100,000 lumens in output. LED performance, electronic drive current and heat compensation are balanced in seconds. The tool analyzes 350 of the latest LEDs from 12 leading manufacturers, 30 heat sinks, 35 LED drivers, and a library of 21,000 electronic passive components. Try out WEBENCH LED Architect at www.national.com/LEDarchitect. ■

Littelfuse Introduces PLED5HT Series Open LED Protector

Littelfuse, Inc. has introduced the PLED5HT Series circuit protection device that increases LED lighting string reliability. The PLED5HT Series design is a voltage-triggered electronic shunt device that provides a current bypass in the case of a single LED failing into an open circuit condition. The design ensures against the loss of an entire string of LEDs due to the failure of a single LED. It also provides protection against electrostatic discharge (ESD) events and accidental reverse battery or power connection.

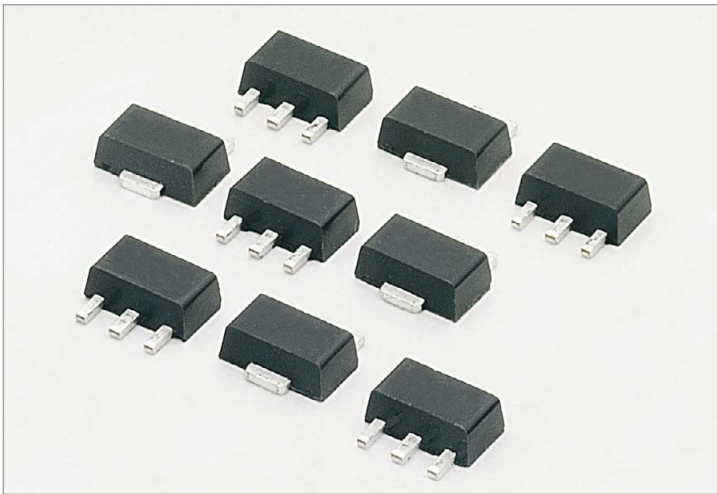

The PLED5HT Series design is a voltage-triggered electronic shunt device that provides a current bypass with auto-reset feature.

Key features and advantages of the PLED5HT Series:

- Brightness of the LED string is maintained if a single LED in the string fails open
- Small SOT-89 footprint makes them inconspicuous and easy to place, while providing good heat-dissipation
- A PLED5HT Series device has a lower power dissipation than the LED, reducing total system power
- 3-in-1 protection (open-defect protection, ESD protection and reverse battery/power supply polarity protection)
- Open LED defects can be controlled without negatively affecting power supply voltage
- Ideal for outdoor lighting fixtures where maintenance costs are high
- Fast switching compatible with pulse width modulation supplies
- Auto-reset after power cycle or if the LED heals itself or is replaced

The PLED5HT Series is RoHS compliant and halogen free, and the SOT-89 package makes for easy mounting and good heat dissipation. PLED5HT Series devices provide the most advanced protection Littelfuse offers for the new generation of outdoor-use LED Lighting applications.

Compared with conventional LED protection measures, Littelfuse PLED5HT Series devices offer a simpler and more economical circuit design. ■

Research News

Philips: First Mains-Powered White-Light OLED Module

Scientists from Philips Research have developed the first-ever organic light emitting diode (OLED) module that can be powered directly from a mains electricity supply. The prototype opens the door to OLED systems that can be directly plugged into standard power outlets without the need for bulky power management circuitry. This will reduce the bill of materials and simplify luminaire design for future OLED-based systems.

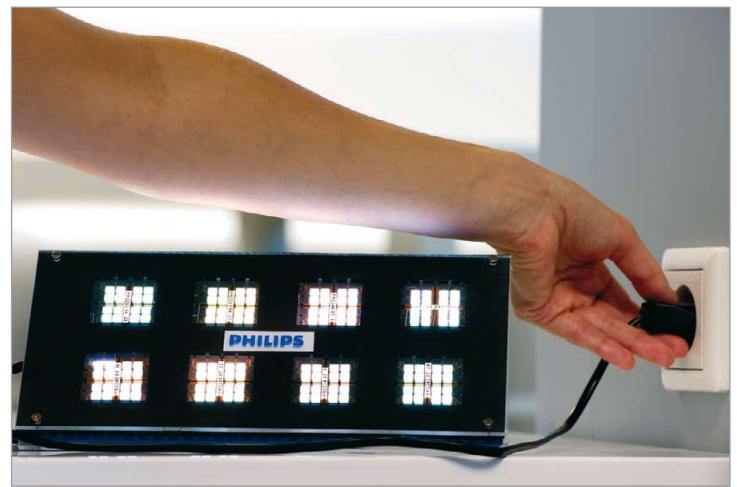

Philips demonstrates world's first 230V AC-powered white-light OLED module.

Like LEDs, OLEDs are solid-state lighting devices that are extremely efficient light emitters. Next to LEDs offering very high brightness in a compact shape, OLEDs emit light over an extended area. The illumination they produce is "calm", glowing and diffuse, and non-glaring. The thin, flat nature of OLEDs makes it possible to create light sources of a wide variety of shapes and sizes.

Moreover, OLEDs are fully dimmable and can produce many different colors as well as whites, including the kind of white light people appreciate from traditional light sources. This makes them an extremely attractive option for general illumination.

"We have combined proprietary interconnect and packaging technology to create this demonstrator," says Dr. Dirk Hente of Philips Research. "We're already seeing AC-driven LEDs coming onto the market. Our prototype marks a breakthrough step towards a similar evolution in OLEDs."

Philips Research has developed its AC-powered module in collaboration with Dipl.-Phys. Holger Spahr, Institut für Hochfrequenztechnik, TU Braunschweig, Germany as part of the TOPAS 2012 project. ■

Event News

Lighting Seminar & Workshop at "Electronica 2010"

Making LED-Light work these days is becoming much more of a systems approach – where efficiency, brightness and life time are dependent on how well all components work together. During the world's largest electronics exhibition – the "electronica 2010" in Munich – Arrow, Cree, RECOM and STC Applied Lighting Technology are running a specialist seminar for design engineers of LED lighting applications. Get two hours of valuable information on the latest trends and developments.

The seminar, under the heading "Powering the Lighting Revolution", is Wednesday, November 10th, 2010 at 2:15 pm in Hall 1 of the new exhibition center, Room A11/A12. It includes well over 2 hours of technical presentations and 1 extra hour of "hands on" experience and individual discussion.

CREE, a leading supplier of LED technology, will speak about the latest trends and developments in High Power LEDs. RECOM Electronics – a pioneer in constant current LED-Drivers – will focus on the technical requirements of LED driver technologies – AC/DC, DC/DC and Buck/Boost – including topics like dimming and PFC. STC presents the latest Thermal Management concepts and Arrow Electronics contributes with an overall system approach. The seminar is free for exhibition visitors. Registration is required at www.recom-electronic.com/led ■



Messe München International

24th International Trade Fair
New Munich Trade Fair Centre
09–12 November 2010

Register online and enjoy the benefits:
www.electronica.de/en/tickets

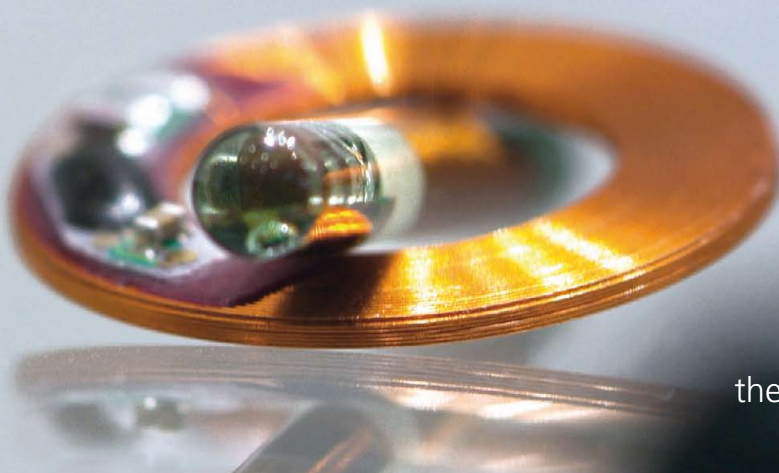

erolqxə
the possibilities of tomorrow.

Automotive | e-Mobility | Displays / e-Signage | Embedded systems / software | Medical / MEMS | Photovoltaics

Time for electronics. Time for the future.
Key topics, trends and technologies. The latest components, systems and applications. Visit electronica 2010, the international trade fair that will show you today what is important tomorrow and generate momentum for real growth.
Parallel event: hybridica. Trade fair for hybrid-component production. www.hybridica.de
get the whole picture



electronica 2010
components | systems | applications
www.electronica.de/en

Feature 1

Citizen accomplished to increase production yield, providing LED within MacAdam 3-step !

Narrower Chromaticity Range (2,700K~4,000K)

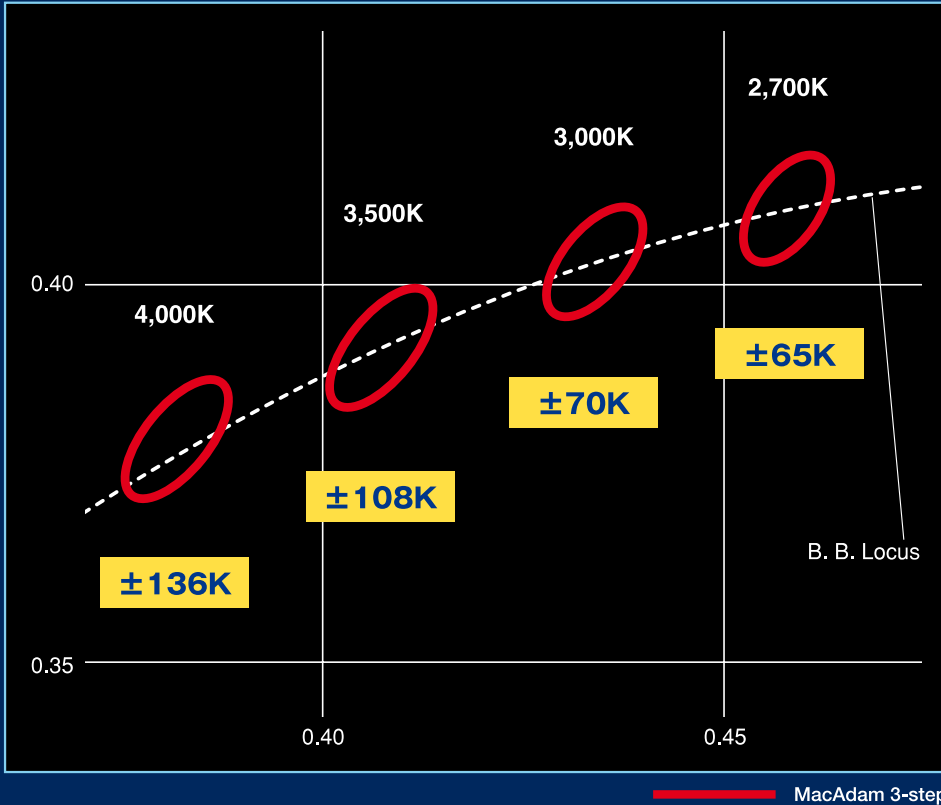

● **Applicable packages**



▶ **Please contact us for samples!**

Feature 2 Coming Soon !

#1 26W class

#2 41W class



26W
CL-L330 Series

- More than 100 lm/W (5,000K)
- MacAdam 3-step
- Production from Q4, 2010



41W
CL-L340 Series

- More than 100 lm/W (5,000K)
- MacAdam 3-step
- Production from Q4, 2010

Visit us !

Hong Kong International Lighting Fair

October 27-30
Citizen booth : Hall 1 1C-C18

Contact

Europe ————— Tel : +49-69-2992-4810
North America ——— Tel : +1-847-619-6700
Japan ————— Tel : +81-3-3493-2744
Asia ————— Tel : +852-2793-0613
Other areas ————— inquiry@ce.citizen.co.jp

Distributors

▶ Visit Citizen Website
http://ce.citizen.co.jp/lighting_led/jp/index.html

● **Requests / Inquiries**
E-mail : inquiry@ce.citizen.co.jp

http://ce.citizen.co.jp/lighting_led/en/

Application

SSL Adoption – Opportunities and Obstacles

> David Hammel, VP of Sales & Marketing Aphos Lighting LLC

The reliability and efficacy of SSL fixtures has been demonstrated in numerous installations for interior and exterior applications. For SSL fixtures, the fastest adoption of various types is occurring in market segments where specific advantages provide solutions that are superior to previous systems. Color changing entertainment lighting was an early and fast adoption given the relative simplicity of integrating and controlling RGB LED's in fixtures. Also, SSL fixtures eliminated the significant expense and maintenance of theatrical color media, heavy gauge electrical cable and extensive dimmer packs. In white light SSL, accent, display, signage and cove lighting were early applications due to the energy efficiency and consistent illumination provided by linear arrays.

Higher performing SSL fixtures with lumen output sufficient to replace 150 W, 250 W and 400 W HID lamps for general lighting interior and exterior applications have become available only in recent years. Consequently, throughout North America in particular, utility companies, municipalities, and commercial interests have only recently undertaken test sites that have demonstrated the energy efficiency, application efficacy and reliability of SSL fixtures. A 2009 study undertaken for the City of Pittsburgh by the University of Pittsburgh, Mascaro Center for Sustainable Innovation, concluded that SSL technology was the best choice over high pressure sodium, metal halide and induction lamp options.



Figure 1: The Aphos Solera™ RW is just one example for a highly efficient LED street lamp to replace conventional technology.

"Analyses of these models indicated that induction and LED lighting currently have similar impacts. However, it is felt that the rapid increase in LED lighting efficiency will soon surpass that of induction. Therefore, we recommend that the city choose LED technology in a multi-year phased purchase of new streetlights. The use of a single technology will benefit the city with reduced maintenance costs and uniform lighting. Pittsburgh has the opportunity to join other cities leading the replacement of streetlights with more efficient technology." [1]

Additionally, accelerating fixture development for applications such as parking lots, parking structures, gas station canopies and others, have provided significant gains in SSL fixture specification and sales in both retrofit and new construction.

Despite these successes, the SSL industry faces obstacles and challenges to achieve adoption on the scope and scale of street lighting and other commercial and industrial general lighting applications. It is critically important to recognize the obstacles affecting the adoption of SSL fixtures. Factors such as the lack of reliable information and documentation, misinformation and the constraints of product development and production are only the beginning. Additionally, it is important to identify the opportunities beyond energy efficiency and lifespan such as optical efficacy, application features and control potential provided by SSL in order for the industry to focus resources and development and achieve the next critical steps in its evolution.

Throughout the past decade of SSL fixture and component development, there has been an inherent limiting factor in product development. Given the fact that SSL fixtures start with PCB based technology, much development of SSL has occurred outside of the conventional lighting industry. Therefore, SSL has often been technology in search of a purpose and a market. Impressive color changing capabilities, energy efficiency and other attributes were not automatically adopted by the lighting industry for one simple reason; they were not typically application driven designs. It should not have surprised or frustrated anyone in SSL that the industry veterans, from lighting designers to contractors were skeptical and even reluctant to embrace SSL fixtures and components. The simple fact was that the SSL industry needed to adapt itself to the lighting industry. To the general lighting industry, there are minimal applications for DMX color changing, more cove lighting systems or moreover, \$40 MR-16 lamps with dubious reliability. The sea of change the last several years has occurred as SSL adapted to the conventional lighting industry where application design integrates the technology and fixture design. Individuals and companies within SSL who had a lighting background recognized that this development provides opportunities across virtually numerous areas of lighting design and integration. The adaptive qualities of SSL optics, compact and modular fixture design, control, low wattage and more, provide for efficiency and application design possibilities that are just beginning to be explored.

According to Bill Little, lighting industry veteran and CEO of Apos Lighting, the key is integrating modern technology and application-centric fixture design. In order to achieve the 150, 175 or 200 lumen per watt potential of SSL (see table 1), manufacturers must address a multiplicity of variables. Little points to the disparity between LED lab performance and the performance of the same devices in real world fixture applications. "It is no longer sufficient to produce fixtures that are simply PCB's placed on a heat sink," states Little. "For true market acceptance and adoption, SSL fixtures must begin with application-centric design and build fixtures around optics, application features, advanced material engineering as well as dynamic heat management. The combination of these factors will achieve the unprecedented efficacy levels we expect to see in the coming years."

Metric	Unit	2009	2010	2012	2015
LED Efficacy (2,580–3,710 K, 80–90 CRI)	lm/W	70	88	128	184
LED Price (2,580–3,710 K; 35 A/cm ²)	\$/km	36	25	11	3
LED Efficacy (4,746–7,040 K, 70–80 CRI)	lm/W	113	134	173	215
LED Price (4,746–7,040 K; 35 A/cm ²)	\$/km	25	13	6	2
OEM Lamp Price	\$/km	130	101	61	28

Table 1: DoE LED Metrics Roadmap [2].

Presently, the value proposition of SSL lighting fixtures is the payback equation of energy and maintenance savings. However, these factors do not sufficiently differentiate SSL from competing systems such as induction and high output T-5 CFL. There are other factors that SSL must employ in order to eclipse these systems. Two primary areas of develop are optics and electrical control.

SSL fixture optics efficacy has the potential to exceed that available for either induction or CFL. Recently the Department of Energy (DOE) developed a Fitted Target Efficacy metric to standardize and quantify SSL fixture performance specifically in pole mounted fixtures. FTE is calculated using the flux within a fixtures uniform pool of light defined as the area meeting the IES recommended uniformity ratio, the percentage of rectangular target covered by the uniform pool and the input power of the fixture. The result is a measure of efficacy that has been fitted to IES distribution types. DOE evaluated hundreds of HID luminaire photometric files to establish ENERGY STAR minimum FTE requirements. Minimum FTEs for SSL luminaries in each category were established to achieve at least 20% energy savings compared to top performing incumbent HID products. For SSL fixtures manufacturers meeting and exceeding this bench mark is an opportunity to achieve significant additional efficacy beyond energy and maintenance savings and to differentiate SSL from induction and CFL.

In addition to FTE, additional optic efficacy can be achieved with customized optic design not possible with induction and CFL. According to Little, "SSL provides the ability to work from the target footprint backwards, to literally design a fixture in reverse, maximizing the potential of a point source and the inherent directional optical control innate to LEDs. SSL manufacturers can provide fixtures which control glare, have crisp cutoffs and place the precise amount of light where it is required."

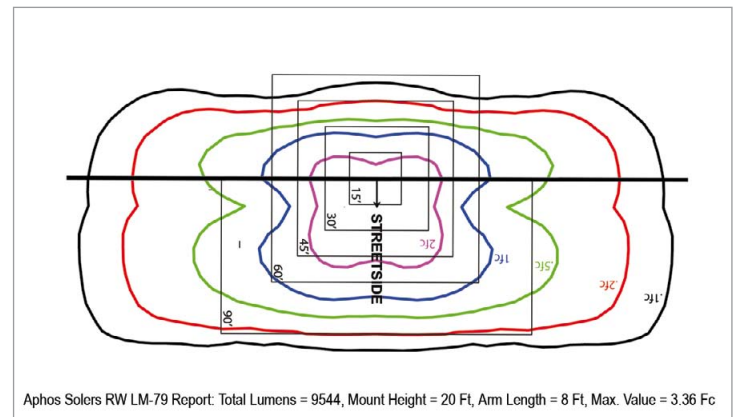

Figure 2: High optical efficacy and even light distribution can hardly be achieved with conventional lighting technologies.

Perhaps no other area of SSL development except energy efficacy, holds more promise for future development and ensures the integration of SSL into general adoption more than system and fixture control. This potential extends from existing systems such as photo and motion sensing which is adaptable to all types of lighting, to advanced monitoring and feedback systems specific to incorporation into SSL driver control. The energy savings of photo and motion sensing are obvious and easily calculated into payback models. SSL gains an advantage over induction and CFL systems given the capacity of LED operation in cold temperatures, with fast on/off cycles and dim to user specified levels without effecting lifespan or reliability of the system. Significant advantages will also be achieved when features such as wireless or stored operational data can be used to monitor ambient and internal temperatures, run time and more. With this data in real time, manufacturers can adjust and extend warranty upwards to lifespan based levels based on actual usage rather than the blanket approach they are forced to use without such data. Additionally, the flexible control potential of SSL will allow lighting systems to integrate into larger smart environments starting in the home and extending to the municipal and onto the national grid level.

Much of the progress in SSL fixture development to date can be attributed to organizations such as the DOE Office of Energy Efficiency and Renewable Energy, IESNA and others. Beginning with the Energy Policy Act of 2005 (EPACT) the DOE has taken a leadership role in fostering the development and adoption of SSL technology as a means to reducing energy consumption in the US. DOE's efforts have been primarily in promoting, planning and in some cases funding research and development.

More recently, the DOE has launched initiatives to identify the specific developments that are needed to make SSL not only effective and competitive in the marketplace but to guide such things as best practices and standardization in the industry. With participation from a variety of SSL, lighting industry and other sources, in 2009 the DOE released the SSL Research and Development Multi-Year Program Plan. In July of 2010, the DOE released the Solid State Lighting Research and Development Manufacturing Roadmap as an addendum to the

previous study. Among other goals, the initiative has identified the manufacturing process for both LED components and SSL fixtures as a critical step to large scale manufacturing that will be required for large scale adoption.

"The primary goal of the Roadmap is to guide the R&D program and to help direct funding solicitations. In addition, it provides guidance for equipment and material suppliers, based on industry consensus on the expected evolution of SSL manufacturing, which reduces risk, and ultimately the cost of undertaking SSL manufacturing. Supporting the development of multiple sources of key equipment and standardized components can also improve quality and lower costs. At the same time, identifying best practices, to the extent firms are willing to share their experiences, can reduce product variability and increase yields."

Specifically regarding SSL fixture development, the Manufacturing Roadmap identified several key issues that need to be accelerated to facilitate production of fixtures. First is the automation of manufacturing and design tools for high quality manufacturing at lower costs and second, improved design and manufacturing for SSL driver manufacturing that reduces cost and maintains quality and performance. As with any industry that experiences the adoption of new technology, these processes must be recognized, funded and implemented in order to provide the basis for success. Many key industry participants have already begun to implement these requirements in many application specific sectors. It is critically important that these steps continue and accelerate to achieve market adoption.

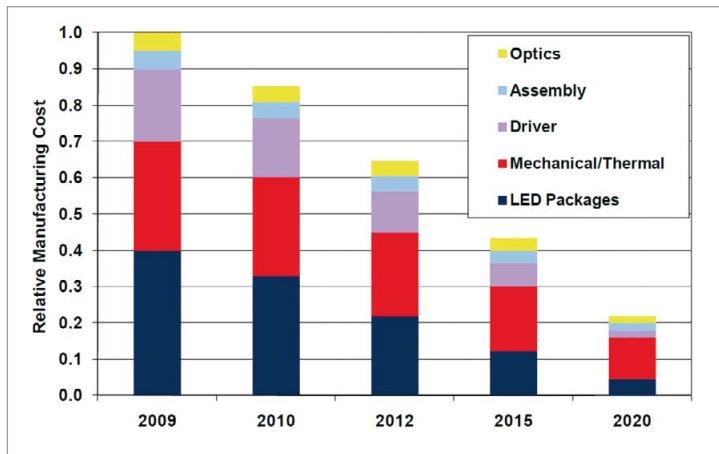

Figure 2: It can be easily seen in this "Projected LED Luminaire Cost Track" [2] that LED luminaires should become affordable within the next years.

The testing and performance standards released over the past several years by organizations such as DOE, IESNA, ANSI, IEC and others, are benefiting SSL fixtures manufacturers in several ways. The recent standards have established testing methods, data criteria and performance criteria where previously only manufacturer's claims and or traditional measurements and criteria existed. However, additional standards and testing methods are needed to provide more detailed and specific data to better differentiate performance levels and quality among manufacturers.

The IESNA (Illuminating Engineering Society of North America) LM-80 and LM79 standards establish uniform testing methods and data for LED components in order to provide accurate comparisons among manufacturers. The LM-80 standard is valuable in that it has established a basis for testing but it does not provide data or processes by which extended LED or SSL fixture lifespan can be accurately interpolated or measured. LM-79 has been very successful in not only establishing continuity of performance metrics but in fostering credibility and reliability of performance data as reported and marketed by manufacturers.

Likewise the ANSI (American National Standards Institute) C78.377 standard has provided a basis for standardizing and quantifying color bins (specific ranges of chromaticity) the across all manufactures. Again, this standard is a significant first step in providing a basis for comparisons and consistent analysis but it does not address the limitations of identifying chromaticity for LED color rendering. Other standards such as the forthcoming CIE (International Commission on Illumination) TC1-69 will provide better measurement and differentiation among LED manufacturers being integrated into fixtures.

Additional standards are needed particularly in the areas of lumen maintenance, color and performance measurement. Given the variable nature of LED performance, the need for global standardization, and the need for SSL technology to establish credible and reliable performance data, it is critically important that the industry not only embraces new standards but participates, supports and promotes the continued development of more standardization for testing methods and performance characteristics.

LED technology is relatively clean by comparison to other lighting technologies and its adoption provides an opportunity to rebuild a significant part of our industry around both energy and materials and sustainability. By embracing public and private initiatives for waste management, end of life recycling and environmental best practices, SSL manufacturers can take the lead and set standards for the general lighting industry.

SSL is on the threshold of a tidal shift that presents unprecedented opportunities for innovation and investment. It is imperative that manufacturers continue to overcome obstacles in order create the disruptive technology shifting the paradigm of the lighting industry. ■

References:

[1] Life Cycle Assessment of Streetlight Technologies, Mascaro Center for Sustainable Innovation, University of Pittsburgh, Pittsburgh, PA, July 30, 2009 Page 44

[2] DoE Solid-State Lighting Research and Development: Manufacturing Roadmap- DOE MYPP: Page 11

[3] DoE Solid-State Lighting Research and Development: Manufacturing Roadmap- DOE Manufacturing Workshop consensus, Page 5

The Basilica Ulpia in Rome



electronica 2010

09-12 November 2010
Neue Messe Munchen
Booth No. A3, 433



Hong Kong International
Lighting Fair

27-30 October 2010
Hong Kong Convention
and Exhibition Centre
Booth No.1B-C16

Zürich Airport, Switzerland



Seoul Semiconductor changing the world!

The most famous places and monuments
are already being illuminated by
Seoul Semiconductors LED's
Tell us about your next bright idea

Oasis of the Seas, the world's largest cruise ship



Russian Business Center



Hotel in Turkey



Eiffel Tower in Paris



Acriche



- Acriche from Seoul Semiconductor, illumination driven directly from AC (100/110/220/230V)
- Eco friendly, energy saving light source



Z-Power LED



Top View LED



Side View LED



Chip LED



Lamp LED



High Flux LED



Illumination



Display & Signs



Automotive



Mobile Appliance



Traffic Signals

Seoul Semiconductor, HQ in Korea
• s1u0n0@acriche.com • Tel +82-2-6913-7515
Official Distributors
• Europe GmbH • Tel +49-69716-750111



SEOUL SEMICONDUCTOR
www.seoulsemicon.com

Characterization

How Much Store Should the Lighting Industry Set by the ANSI Standard for LED Chromaticity

> Thierry Suzanne, Applications Engineer, Future Lighting Solutions

It is increasingly common to find the claim in LED manufacturers' marketing materials that an LED 'complies with' ANSI specifications for Correlated Colour Temperature (CCT). The ANSI standard for chromaticity is useful for specifiers of white LEDs. Previously, a customer who wanted to compare one manufacturer's 'neutral white', 'cool white' or 'warm white' LED with another's was faced with conflicting chromaticity classifications, and conflicting approaches to the tolerance to be allowed within each classification.

The ANSI standard imposes a degree of uniformity on manufacturers' approaches to chromaticity classification. Lighting equipment OEMs, and lighting designers and specifiers should not, however, take an LED manufacturer's statement of 'compliance with ANSI' as a guarantee of high-quality light output under all conditions.

What the ANSI Specification Covers

ANSI stands for American National Standards Institute (www.ansi.org), a US organisation which creates a set of voluntary standards in various industry sectors. These standards represent an agreement by those in an industry, and they provide specifications for that industry's products. An important purpose of the standards is to allow customers to distinguish products that exceed a certain quality threshold from cheaper but inferior alternatives.

In the field of lighting, ANSI standards cover several different aspects of luminaires, and are not only concerned with LED lights. Those standards that impinge on the LED industry have been designed to be compatible with existing lighting standards for conventional light sources – this aids their adoption in the large number of LED lights that are designed as retrofit replacements for traditional lamps.

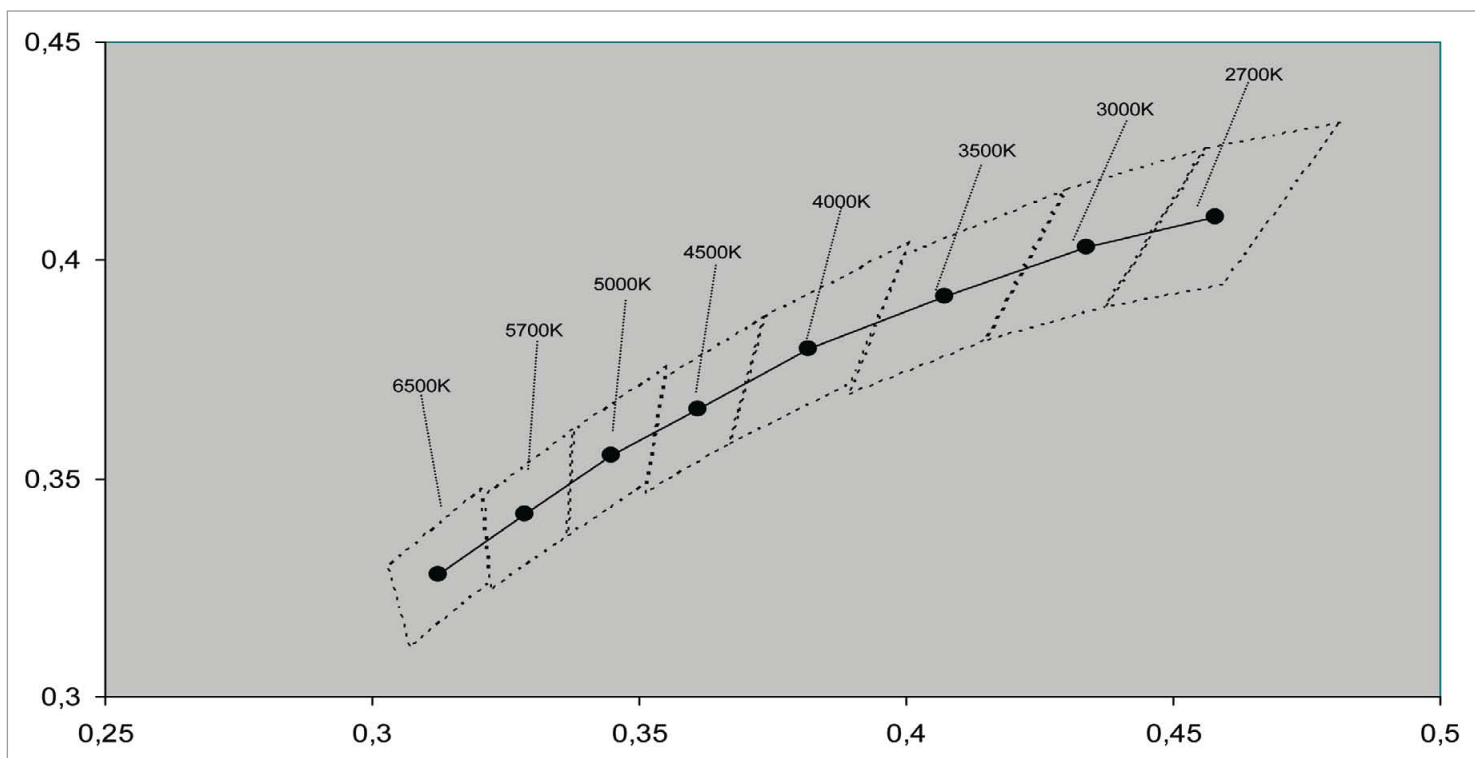

	2,700 K		3,000 K		3,500 K		4,000 K		4,500 K		5,000 K		5,700 K		6,500 K	
	x	y	x	y	x	y	x	y	x	y	x	y	x	y	x	y
Center point	0.4578	0.4101	0.4338	0.4030	0.4073	0.3917	0.3818	0.3797	0.3611	0.3658	0.3447	0.3553	0.3287	0.3417	0.3123	0.3282
Tolerance Quadrangle	0.4313	0.4319	0.4562	0.4260	0.4299	0.4165	0.4006	0.4044	0.3736	0.3874	0.3551	0.3760	0.3376	0.3616	0.3205	0.3481
	0.4562	0.4260	0.4299	0.4165	0.3996	0.4016	0.3736	0.3874	0.3548	0.3736	0.3376	0.3616	0.3207	0.3462	0.3028	0.3304
	0.4373	0.3893	0.4147	0.3514	0.3889	0.3690	0.3670	0.3578	0.3512	0.3465	0.3366	0.3369	0.3222	0.3243	0.3063	0.3113
	0.4593	0.3944	0.4373	0.3893	0.4147	0.3814	0.3898	0.3716	0.3670	0.3578	0.3515	0.3487	0.3366	0.3369	0.3221	0.3261

Figure 1: Fixed CCT values as specified by the ANSI C78.377-2008 standard.

It is true to say, of course, that ANSI specifications have no formal authority in Europe, since ANSI is a US body. But in the absence of any other reference or standard for LED lighting, ANSI is becoming the de facto standard worldwide, and it is now widely recognized in Europe as a mark of quality.

The most important ANSI standard for the LED lighting industry, and the one with the greatest potential to create controversy, is ANSI C78.377-2008, which specifies the chromaticity of solid-state lighting products.

The purpose of this standard is to specify the chromaticity values recommended for general lighting. The values of CCT used in this specification are themselves based on a previous standard, ANSI C78.376-2001: this specified chromaticity values for fluorescent lamps. The newer standard C78.377 adds two CCT values (4,500 K and 5,700 K) to those already defined in C78.376.

An important element of the standard is its definition of 'tolerance': that is, how far from the nominal CCT value an LED's actual output is allowed to be. In the ANSI standard, the tolerances for the six nominal CCT values are given as ellipses in the (x,y) chromaticity diagram. A tolerance of seven MacAdam ellipses is allowed in this standard. Figure 1 shows the fixed CCT values defined by ANSI C78.377 – these are consistent with their fluorescent lamp counterparts. But the standard also allows for 'flexible CCT' specifications. This reflects the large element of choice that LEDs offer the luminaire designer – for instance, LED technology allows the luminaire to produce light output with chromaticity of 2,800 K or 2,900 K; in some applications, this can be a more appropriate shade of white light than 2,700 K or 3,000 K.

So the 'flexible CCT' provisions of ANSI C78.377 allow the LED manufacturer to set a nominal CCT value of their own choosing (in 100 K steps between 2,700 K and 6,500 K) – but the standard still defines a maximum tolerance of seven MacAdam ellipses centered around this nominal value (see Table 1).

Nominal CCT	Target CCT and tolerance (K)	Target D_{uv} and tolerance
2700 K	2725 ±145	0.000 ±0.006
3000 K	3045 ±175	0.000 ±0.006
3500 K	3465 ±245	0.000 ±0.006
4000 K	3985 ±275	0.001 ±0.006
4500 K	4503 ±243	0.001 ±0.006
5000 K	5028 ±233	0.002 ±0.006
5700 K	5665 ±355	0.002 ±0.006
6500 K	6530 ±510	0.003 ±0.006
Flexible CCT (2700 - 6500 K)	T ±ΔT	$D_{uv} \pm 0.006$

Table 1: Nominal CCT values defined by the C78.377 standard.

This, then, explains the tolerance allowed for nominal values – but the measured values of manufactured LEDs will not necessarily equate to their actual values. In other words, a tolerance for the chromaticity measurement equipment also needs to be taken into account.

Unfortunately, a maximum testing tolerance is not specified in the ANSI standard. Luminaire designers should therefore ask the manufacturer of any LED under evaluation for the testing tolerance applied to the LED's performance data. It is important not to overlook the significance of this tester tolerance when evaluating rival LEDs. The effect is well illustrated by Figure 2: here, the effect of different measurement tolerances can be seen on the range of actual CCT values of LEDs that are nominally classed as 2,700 K devices.

As Figure 3 shows, the actual variation in color output from one 'identical' ANSI-specified LED to another could be far greater if a tolerance of 0.01 (x,y) is allowed than if a stricter tolerance of 0.005 (x,y) is applied. In fact, a nominal 2,700 K LED could have an actual color temperature that would qualify it as an ANSI 3,000 K LED if the looser tolerance of 0.01 (x,y) is allowed. So it is vital that luminaire designers establish the testing tolerance applied by the supplier of every LED they evaluate in order to be able to carry out a fair comparison of LEDs from different manufacturers. Very accurate manufacturers test to a tolerance of 0.005 (x,y), some manufacturers test to a tolerance of 0.01 (x,y), and some do not state publicly what the measurement tolerance is.

(It should be noted that LED manufacturers might also state testing tolerance as a percentage of the CCT value. For instance, Philips Lumileds quotes a CCT testing tolerance of ±5% for its 'Illumination Portfolio' of LUXEON Rebel ANSI-binned LEDs in its datasheet. In fact, the CCT value is a different parameter from the (x,y) chromaticity value; (x,y) values more precisely express the color output of a light source, and the testing tolerance expressed as an (x,y) value is the more important parameter.)

Manufacturers Implement Radical New Binning Structures

The enormity of the change that an LED manufacturer has to make in order to comply with the new ANSI chromaticity specifications is made clear in Figure 3, which shows a new ANSI-compliant binning structure applied by manufacturers like Philips Lumileds.

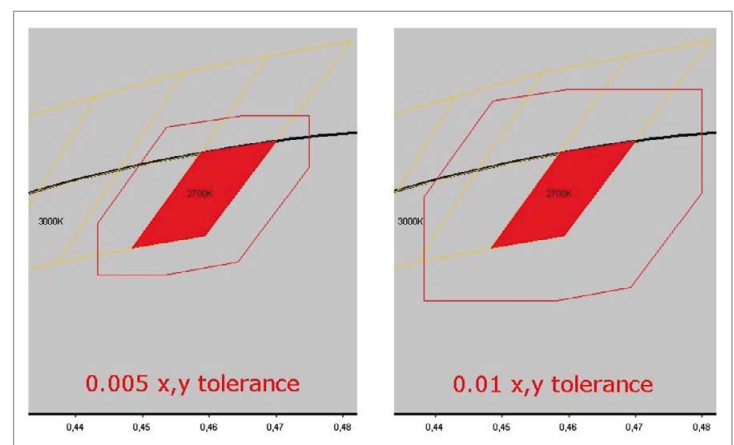

Figure 2: Measurement tolerance dramatically affects the real, as opposed to nominal, bin size.

This new binning structure is in pink, the old one is shown in the background (in orange for warm white, yellow for neutral white and blue for cool white).

Each CCT value specified in the ANSI standard is covered by 4 different colour bins called xA, xB, xC and xD (where x refers to one specific CCT value). Figure 3 shows that some manufacturers have shrunk the size of its bins, and centred them tightly around the blackbody locus. A remarkable feat of manufacturing, this bin re-engineering gives LED users a much more precise and accurate colour output in each bin, and thus enables the production of luminaires with enhanced colour consistency within LED arrays, and across batches of luminaires.

The best LED Illumination parts do not only comply with the ANSI chromaticity specifications, since they also provide a minimum CRI rating. This minimum guaranteed CRI complies with the ANSI LM-79 standard.

Conclusion

If the lighting industry is still to wholeheartedly embrace the opportunity presented by LED technology, it is perhaps most of all because of a perceived lack of consistency and quality in light output from this new light source.

The ANSI standard C78.377-2008 goes some way towards answering the concerns of luminaire manufacturers and lighting designers, since it fairly tightly specifies the chromaticity range within which an LED manufacturer can claim any given nominal CCT value.

But users must exercise extreme caution when evaluating apparently 'ANSI compliant' LEDs, since the absence of a maximum measurement tolerance for testing manufactured LEDs gives producers scope to, in effect, increase the size of each quadrangle on the ANSI colour chart while still claiming compliance. At worst, LEDs marketed as being within ANSI specifications for a single colour point could show colour differences that are apparent to the naked eye.

Further, the ANSI standard imposes no requirement on producers in relation to colour consistency over time, temperature or drive current – yet all three factors are known to affect chromaticity to some extent in certain types of LEDs. So a device that is ANSI-compliant when new might not be after a certain operating period – and any such variation is currently allowed within the terms of the standard.

So while it is today preferable for devices to be compliant with the ANSI chromaticity standard, the industry would benefit from further development of it to give users more useful grounds for comparison between devices, both when new and after a period of operation. ■

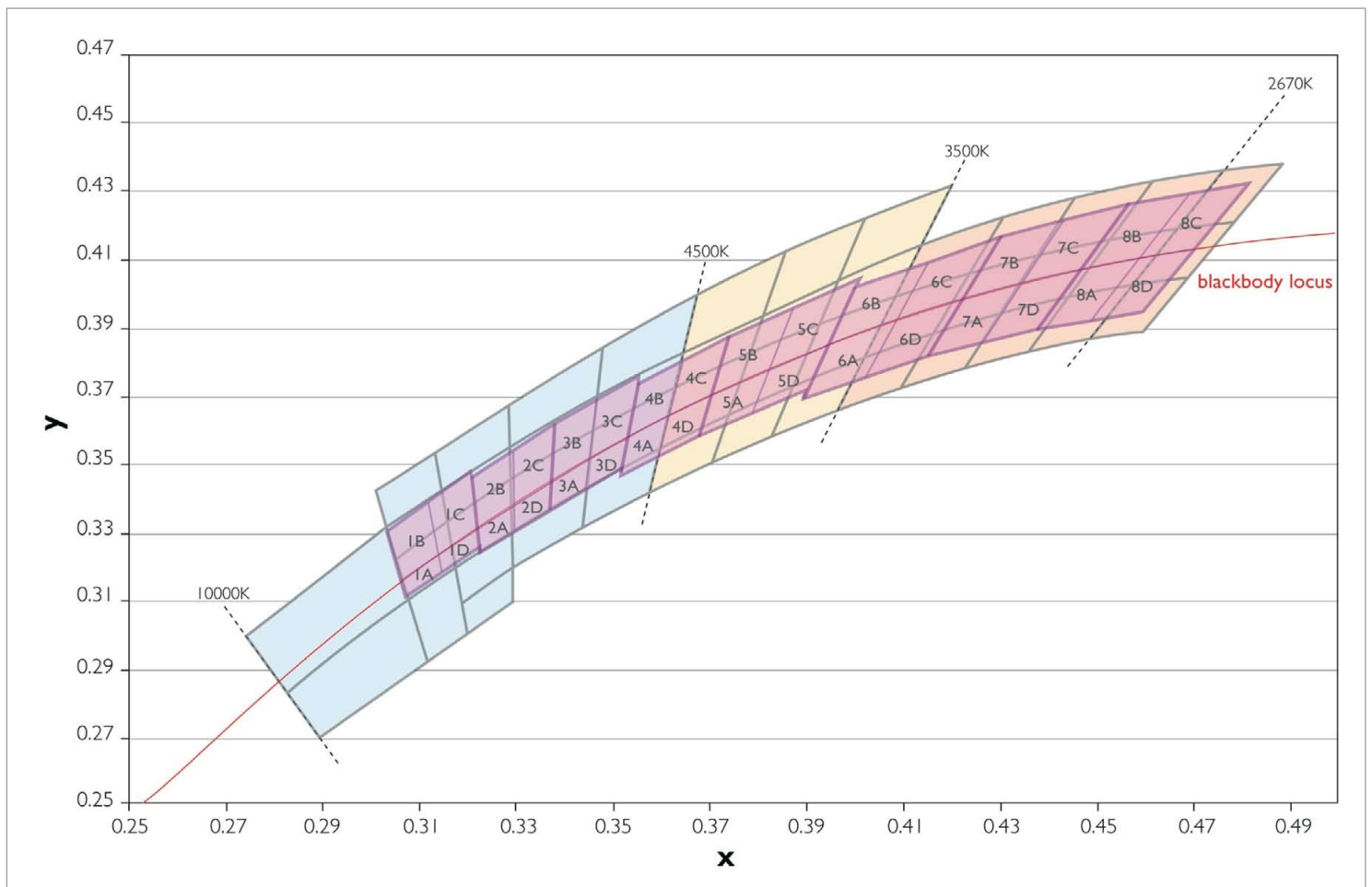
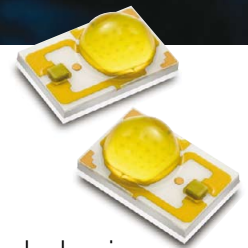

Figure 3: Philips Lumileds LUXEON Rebel Illumination Portfolio binning structure.



Transforming Light

LUXEON LEDs are changing the way we light the spaces we live, shop and play in. With unparalleled efficiency, quality, and reliability, LUXEON LEDs are a simple way to transform lighting and improve the well being of our environment.

Whether you're lighting a restaurant, roadway or architectural masterpiece, you can count on LUXEON to deliver long life, high-quality white light while reducing energy consumption.

To learn how LUXEON can help you transform lighting, call our partner, Future Lighting Solutions U.S. +1-888 589 3662, Europe + 00 800 443 88 873 or visit www.philipslumileds.com

L U X E  N[®]

PHILIPS
LUMILEDS
sense and simplicity

Technology

Factors That Drive LED Reliability

> Dr. Randy Kong, DfR Solutions

Semiconductor-based light emitting diode (LED) devices first appeared in the 1960s. Today, with the advances in materials, design and manufacture of LED devices, we are seeing a wide spectrum of LEDs that are cheaper, more colorful, more efficient, more intense, and more reliable. LED applications include signs and indicators, sensors, communication devices, displays, and increasingly solid state lighting and backlighting for TVs and monitors. The supply chain of LEDs can include producers of LED chips, packaging houses, LED driver chips and system integrators (e.g., LED light bulb). Large players in LED chip manufacture include Nichia, Philips, Osram and Cree.

Lighting typically has the biggest consumption of on-site electricity. In this case, LED provides unique advantages in solid state lighting for its power efficiency and reliability. As an example, the Pharox 500, equivalent to a 60-watt conventional bulb from Lemnis Lighting (Figure 1), consumes 7 watts and lasts for ~25 years [1]. The cost is currently projected to be under \$40 and can go down to \$10 in five years driven by demand and improvements in the electronics. Philips predicts that LEDs will make up 80% of the general illumination market by 2020.



Figure 1: An LED light bulb from Lemnis Lighting.

The exciting solid state lighting market developments will pose interesting reliability challenges. For example, solid state lighting depends on a high power LED which generates much heat. Additionally, they are often used in uncontrolled environments such as outdoors. In this paper, we'll explore the driving factors affecting LED reliability.

How LED Fail

At device level, the LED is a forward-biased diode that enables radiative carrier recombination resulting in light output. LEDs can be classified according to the light colors or power intensities. Or they can be distinguished based on the base materials systems such as GaAs, InGaP, GaN, ZnSe, Si and even organic compounds. They can also be differentiated based on the device and package designs, e.g., quantum dot LEDs, top emitting and side-emitting LEDs.

LEDs typically display a wear out failure mode due to long term drift of critical output characteristics, e.g., light intensity or color shifts. LEDs can also fail in more catastrophic manners due to flaws in component materials, structures and assembly related stresses.

LED component suppliers often use 50% light intensity degradation as the LED failure criteria, though the actual end usage scenario can drive application-specific requirements such as related to the color correctness, intensity, uniformity of the LED light output. There is a difference in measuring the radiometric vs. photometric light intensity, with the latter weighted by human eye sensitivity to visible light. For example, a sensor application in machine vision application would likely depend on radiometric intensity changes rather than the photometric changes. LEDs do not always decrease monotonically in its light output; certain LED technologies can display a temporary reverse-degradation behavior with increased light output after ageing, which could pose risks for eye-safety sensitive applications.

In addition to determining failures based on LED output characteristics changes, one can also monitor the operational parameters of the LED such as when the forward voltage shift, forward or reverse leakage currents exceed pre-defined limits.

LED Reliability

LED reliability will be determined by all its constitutive parts and their reactions upon environmental or operational stresses. We discuss the primary drivers from the perspective of the LED die and package below.

LED Die

From the semiconductor die perspective, the two dominant stresses affecting LED reliability are the LED forward drive current and operation temperature.

Atomic defects such as dislocations contribute to the reduced probability of photon generation thus the degradation of the LED light output. These defects serve as non-radiative recombination centers and generate heat instead of light. In many materials systems such as GaAs/AlGaAs, high forward drive current density causes electromigration, which is responsible for the nucleation and growth of dislocations and other defects in the region where the radiative recombination occurs. The speed at which these lattice defects increase depends on the magnitude of the forward current density.

Apart from high current density driving bulk crystal defects, ionizing radiations can also lead to the creation of atomic defects. Along the



FORUM LED EUROPE

CONFERENCES + EXPO

7/8 DECEMBER 2010

Lyon - FRANCE

Cité Centre de Congrès

THE INTERNATIONAL MEETING PLACE
FOR KEY PLAYERS IN THE LED INDUSTRY !



www.forumled.com



Cluster
Lumière
Performance & Innovation

An event organised by



I'm interested in ForumLED 2010 - To be returned by fax to + 33 (0)4 37 40 31 69

Company: _____ Name: _____ Job title: _____

Phone N° : _____ Fax N° : _____ Email: _____

- I wish to exhibit on a stand of ____ Square meters
- I also wish to lead a workshop
- I wish to receive more information



Contact / information : Romain CLEVY Tel: + 33 (0)4 37 40 31 64

LED

chip edges, high electrical currents or voltages, particular at elevated temperatures, may result in electrode metal (e.g., ITO, Ag) diffusing into the active region, resulting in leakage current and non-radiative recombination.

The atomic defect generation and growth can be accelerated at higher temperatures. The semiconductor-based temperature acceleration factor is often modeled by Arrhenius equation. There can be interactions between the drive current density and temperature. For example, in case a simple bias resistor is used to control LED forward current, drive current may increase at higher temperatures. Most of the electron-hole combinations that don't result in photons create heat, and LEDs generate less light as they get hotter. These two factors can not only accelerate the atomic defect growth, they can also lead to thermal runaway especially for high power LEDs. In addition to reliability concerns, critical performance parameters such as emitted light intensity as well as wavelength may shift as the junction temperature rises.

As discussed in an earlier DfR Solutions publication [2], another type of defect affecting LED performance and reliability is the threading dislocations (TD). Threading dislocations form in highest densities on sapphire based GaN LEDs, where there can be migration of contact metal through the hollow center of the dislocation, creating an Ohmic resistive path between the P and N regions of the die, disabling the LED function.

LED Package

In addition to protecting the semiconductor die from direct environmental exposures and facilitating the interconnection of LED to the system; the LED package also plays an essential role for the LED optical, thermal, mechanical and electrical performance and reliability requirements as discussed below:

Optical: Package optical properties can be affected by epoxy and phosphor degradations when exposed to temperature, moisture, UV radiation. Optical performance is also affected when air gap forms, e.g., due to delamination, or when materials optical property/geometry changes. Such changes can modify the optical path, reflectivity and index of refraction matching across the device layers before photons can be emitted efficiently.

Thermal: Thermally, low power LED dissipates heat primarily through its lead whereas high power LED depends more on the packages. For example, most high power LEDs are SMT type that can be directly mounted onto a heat sink. In some cases, package degradation can contribute more to the light output degradation than the LED die itself, as silicone and epoxy may deteriorate faster over time. Packages for state-of-the-art high power LEDs are much more sophisticated than early LEDs, e.g., they may be mounted on metal-core PCBs to provide efficient heat transfer. However, one should not simply be satisfied with an acceptable "macro" junction temperature. LEDs with design or manufacture package flaws may result in non-uniform heat conduction across the die active region, resulting in current crowding and local heating, posing risks of thermal runaway. Heat can also degrade the different phosphors used in white LEDs. The degradation rates for these phosphors may vary, causing changes in the eventual output light color. For example, purple and pink LEDs with an organic phosphor formulation may degrade after just a few hours of operation resulting in output color shifts.

In addition to high temperatures and high humidity operation degradations, the LED package is susceptible to failures during temperature cycling and when the package is exposed to low temperatures. Thermal cycling can cause thermal fatigue failures related to wire-bonding, die attach and die-package delamination. This can be traced to the incompatibility of package structures/materials and the environmental/operational stress experienced. Presence of manufacture defects such as poor intermetallic formation at the ballbond or inadequate die attach can be particularly susceptible in these scenarios. In addition to issues exposed at high temperature or temperature cycling, an LED package exposed to very low temperature may exert mechanical stress on the LED die, to the extent of causing die cracks.

Mechanical: Mechanical integrity of the LED is another critical aspect that demands attention throughout the package design, assembly and system integration. The compound semiconductor used in LEDs possesses different mechanical strength when compared to, e.g., Si. The wire-bonding process parameters need to be carefully designed and controlled in order to form a quality bond without, e.g., generating bonding or die weaknesses. In LED assembly to PCBAs, package stress can be introduced due to lead bending or soldering actions, which can introduce package and die defects leading to early failures.

Electrical: As a semiconductor device, LEDs will be susceptible to electrostatic discharge (ESD) and electrical overstress (EOS). ESD may cause immediate failure at the diode junction, or a shift in its

Ocean Optics
Jaz does it all!!

Universal Portable Light Meter

Strategies in Light Europe
The Leading Forum for the Global LED and Lighting Industry
Visit us at Strategies in Light
28-29 sept 2010 at stand 28

www.oceanoptics.eu
info@oceanoptics.eu

Lumen
Lux
PAR
CRI
CIE
CCT

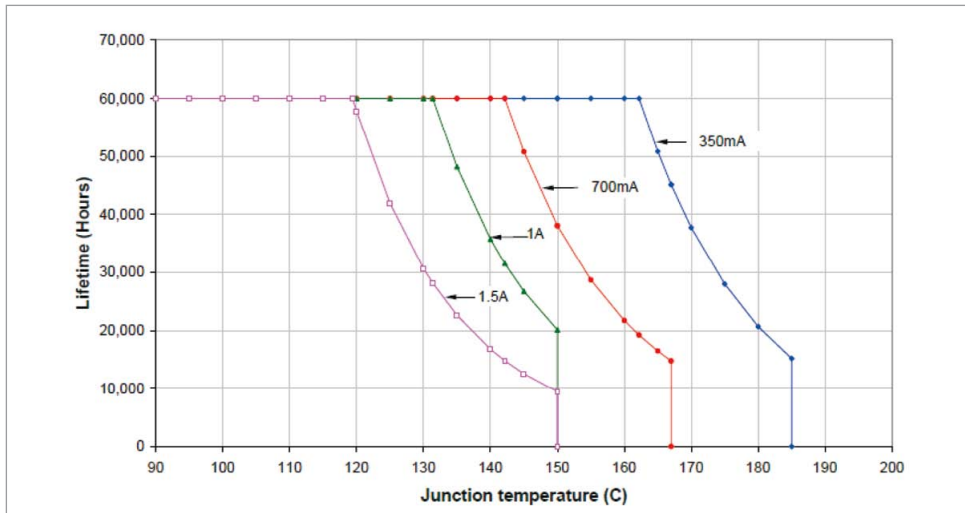

Figure 2: The (B50, L70) lifetimes for InGaN Luxeon K2 LED family from Philips Lumileds.

parameters, or latent defect causing delayed functional failures. As EOS examples, power-line coupled transients and surges can degrade LEDs. And the reverse-breakdown mode for some LED types can occur at very low voltages where any excess reverse bias may cause immediate degradation [2].

Conclusion

In integrating LED devices into a system, the first order business is to carefully evaluate the application environmental and operational stress conditions in order to select the LEDs with the proper strengths. For example, thermal and moisture environment exposures and controls, voltage/current fluctuations including the likelihood of ESD/EOS incidents, UV light intensities, etc. should be examined. Don't forget details such as soldering temperature exposure, mechanical stress on the package due to specific mounting methods can all contribute to the reliable operation of the LED. Based on relevant application requirements, suppliers' reliability data should be carefully evaluated and analyzed for differences in test conditions, failure criteria. As an example, manufacturers may specify and test the LEDs at room temperature using pulse rather than continuous current. In this case, the LED junction temperature can stay at room

temperature, demonstrating much better reliability than in actual applications if continuous current is used.

When it comes to predicting the wear-out life of LED, the typical durability of LEDs makes it impractical to obtain meaningful experimental data relevant to real applications, as it is hard to extrapolate future behaviors across populations based on limited testing scope. For solid state lighting, Philips prescribed a simplified approach that helps lighting designer to define operation conditions related to the so-called "B50/L70" lifetime [3], i.e., when 50% of the products have at least 70% lumen maintenance for the projected operating hours (Figure 2). The statistics is based on Philips' internal testing data and is graphically presented with reference to driving current and junction temperature. It is unknown what design margins are provided based on this approach and one can expect variations across vendor bases, technology platforms, production processes, and more importantly, specific system design and deployment. Frequently, a quality LED that is properly integrated into a system can experience much longer life than the rest of the system and may be the last concern when evaluating the overall system reliability. ■

References:

- [1] http://news.cnet.com/8301-11128_3-20004760-54.html?tag=newsEditorsPicksArea.0
 [2] J. Arnold, "When the Lights Go Out: LED Failure Modes and Mechanisms" *Electrical Source Magazine*; November-December 2008; pp 10-13
 [3] <http://www.philipslumileds.com/pdfs/WP12.pdf>

- versatile product range of heatsinks, optimised manufacturing techniques
- customer-specific machining, modifications and special design



LED-heatsinks acc. to customer specified demands
 optimized cooling concepts, prototype construction,
 advice with application based "thermal management"



LED heatsinks
 LED-mounting surface with additional copper
 plating, powerful heat dissipation



Star shaped heatsinks and extruded profiles
 application for LED-light cases, for fixed and
 flexible LED-line modules, profiles sold by the meter

P. O. Box 1590 D-58465 Lüdenscheid
 Notebohmstraße 28 D-58511 Lüdenscheid
 Tel. +49 23 51 4 35-0 Fax +49 23 51 4 57 54
info@fischerelektronik.de
www.fischerelektronik.de

We exhibit:
electronica
 Munich, 9.-12.11.10
 hall A 2, stand 155

Thermal Management

Junction Temperature in Package Design – The Key To Optimal Heat Dissipation

> Kay Fernandez, Product Technology Manager, Lumex

General lighting is a 24 billion dollar industry. With a projected 39% annual compounded growth projected over the next five years, the high power LEDs used in general lighting applications represent the fastest growing segment of the LED market.

Several major manufacturers are working to meet this growing demand and the size of the market has caused a number of new, smaller companies to spring up in an attempt to capture some of this exciting new market share. In a crowded market with over 400 companies describing themselves as "lighting companies," there is a wide variation in the quality of high power LED products provided.

Distinguishing quality LEDs from inferior technologies most frequently centers on identifying LED products designed with superior thermal management. Optimal heat dissipation is key to quality high power LED performance. Non-optimal heat dissipation can lead to:

- Loss in efficacy
- Decrease in life hours
- Color degradation

Understanding the basic elements that influence junction temperature as well as the passive and active cooling techniques available to influence junction temperature is essential to achieving reliable high power LED performance.



Figure 1: An LED package with a low thermal resistance, like the TitanBrite High Power LED package, is mandatory for manufacturing durable, efficient high quality solid state lighting products.

Junction Temperature

Junction temperature is the temperature inside the LED die at the boundary area where the P semiconductor and N semiconductor meet. Maintaining the junction temperature as cool as possible is critical to ensuring reliable high power LED performance.

Junction temperature can be calculated by the following equation;

$$T_j = T_a + R_{th(j-a)} \times P$$

T_j = Junction Temperature
 T_a = Ambient Temperature
 $R_{th(j-a)}$ = Thermal Resistance between junction and ambient atmosphere
 P = Power Dissipation

Though high power LEDs provide optimum performance when the junction temperature is at -30°C , this is not a realistic temperature goal for most high power applications that face significant internal and external heat challenges. Controlling junction temperature to be as low as possible and well below the 125°C failure point is essential. (maximum junction temperatures do vary, but for ease of explanation this article will use 125°C)

In order to maintain optimal junction temperature, it is important to consider every possible way to pull the heat generated in the PN junction of the LED diode away from the LEDs. Heat travels along the path from the junction to the soldering point, soldering point to PCB and PCB to heat sink to the ambient environment. Thermal conduction, convection and radiation are the three methods of generating this heat transfer.

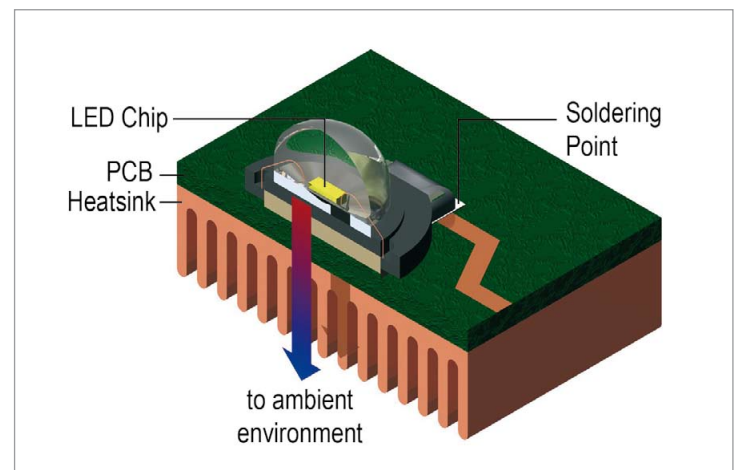

Figure 2: Thermal path – A visual demonstration of how heat travels from the junction out to the atmosphere.

Thermal Conduction

Thermal Conduction refers to thermal energy transferring within a material to balance the temperature between a higher temperature area and a lower temperature area.

Thermal Conduction can be calculated by Fourier's law, which states that the speed of heat transferring within a material depends on the temperature differences and area.

Fourier's Law:

$$Q/t = kA(T_{\text{hot}} - T_{\text{cold}})/x$$

$$Q/t = \text{heat transfer speed}$$

$$k = \text{thermal conductivity of material or ability to conduct heat for that material (in } W \cdot K^{-1} \cdot m^{-1} \text{)}$$

$$A = \text{cross-sectional surface area}$$

$$T = \text{temperature}$$

$$x = \text{thickness of material between the ends}$$

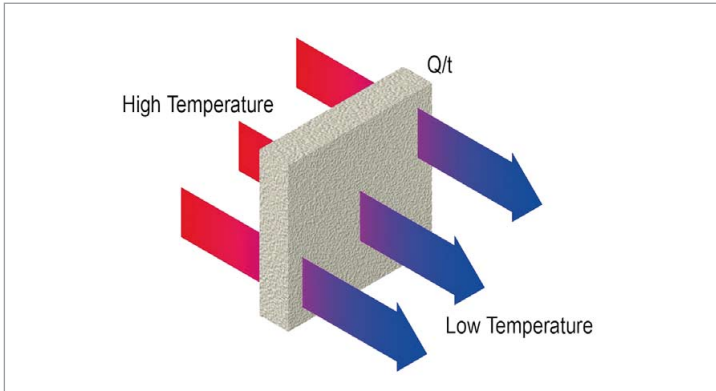

Figure 3: Thermal conduction – A visual demonstration of how thermal energy transfers from higher temperature areas to lower temperature areas.

Convection

Convection is the transfer of heat from one place to another by the movement of fluids. The movement of fluid in bulk enhances the heat transfer between the solid surface and the fluid. Most commonly, the fluid used in convection cooling is air. Convection is defined by Newton's law of cooling, which explains that the rate of heat loss of a body is proportional to the difference in temperatures between the body and its surroundings. Mathematically, the equation that describes this is:

$$Q = -h A \Delta T(t)$$

$$h = \text{heat transfer coefficient}$$

$$A = \text{surface area of heat transferred}$$

$$\Delta T(t) = \text{time dependant thermal gradient between the object and the environment}$$

Radiation

Thermal radiation is the transfer of heat to the surroundings area. Nearly all objects emit heat in this way. This can be modeled using a black body developed and described by the Stefan-Boltzman Law. The Stefan-Boltzman Law describes the amount of energy that would be absorbed by a blackbody (an ideal absorber of heat that absorbs all radiated heat)

The following equation describes the rate of heat absorption in Watts:

$$q = \sigma T^4 A$$

$$\sigma = \text{the Stefan-Boltzman constant, } 5.6703 \times 10^{-8} \text{ (W/m}^2\text{K}^4\text{)},$$

$$T = \text{the temperature at the surface of the emitting body in Kelvin (K) and}$$

$$A = \text{the area of the emitting body.}$$

Three Key Elements to Consider When Addressing Junction Temperature

To keep the junction temperature as low as possible and well below the 125°C failure point, there are three elements that are imperative to consider:

- thermal resistance
- substrate material
- ambient temperature

Thermal Resistance

The thermal resistance of an LED pertains to how well heat at the junction is conducted from the LED die out to the ambient environment. The lower the thermal resistance of a high power LED technology, the easier heat can be pulled away from the junction ensuring better performance. Understanding the thermal resistance of a high power LED is key to planning junction temperature heat dissipation.

Thermal resistance is a ratio of the differences in temperature to the power dissipated (deg.C./Watt). From the equation for junction temperature calculation; thermal resistance, $R_{th(j-a)}$, can be calculated by

$$R_{th(j-a)} = (T_j - T_a)/P$$

Thermal resistance is additive along thermal path. Per below picture, thermal resistance from junction to ambient

$$R_{th(j-a)} = R_{th(j-c)} + R_{th(c-b)} + R_{th(b-a)}$$

Substrate Material

The FR-4 (standard PCB) substrate used by many general electronics applications is not well-suited for eliminating heat because of the low heat conductivity property of the material. While using increased copper content in the PCB traces may have some small effect on heat dissipation, using materials in a planar form will have a much greater impact. This is possible by using a continuous copper layer, or aluminum which has far more efficient heat dissipation characteristics. Metal core PCB boards provide superior heat dissipation performance.

Ambient Temperature

Ensuring low junction temperature requires having a thorough understanding of the environment in which a high power LED will perform. The internal junction temperature is heavily influenced by the internal and external environmental elements that surround the LED. Elements that play a key role in determining ambient temperature include:

External temperature

Is the high-power LED going to be used indoors or outdoors? For outdoor applications – what is the external temperature range anticipated for the region's climate? Will it be extremely hot in summer months and very cold in the winter? Or will the technology live in a milder climate?

For indoor applications – temperature ranges are also very important. For example, will the high power technology be used to illuminate a busy industrial environment with significant heat generation – or a chilled warehouse? External temperature range must be considered when designing a heat dissipation plan for high power LED technologies.

Radiation of nearby components

Motors, transistors, transformers, drivers, heaters, high power LEDs and other heat generating components will impact ambient temperature and raise the junction temperature. We can use the Stefan-Boltzman Law to model this.

To see how the Stefan-Boltzman Law applies not to an ideal black body absorbing surface, but to an actual LED technology, consider for example, a 1W LED die to be the emitting area and to be ideal (close enough for this example) we see the following constants, $T = 298\text{ K}$, $A = (1\text{ mm})^2$, we see the following result:

$$q = 5.6703 \times 10^{-8} (298)^4 (0.001)^2$$
$$q = 0.3901\text{ mW}$$

This gives us an idea of how much heat would be radiated by another LED, in this case a 1 watt LED. Though this is not a significant amount of heat emission, it is clear that if there were a large array of these 1 W LEDs, the aggregate heat emission could be substantial, especially in sealed enclosures that do not benefit from air flow.

LED enclosure

The type of enclosure used on a high power LED application also impacts junction temperature. Non-enclosed LEDs can benefit from the cooling properties of air flow. However, many applications require LEDs to be hermetically sealed in order to ensure protection from environmental factors. This has considerable impact on junction temperature as the elimination of air flow can cause temperatures to rise.

Active and Passive Cooling Techniques for Achieving Desired Junction Temperature

Junction temperature can be addressed by a number of different passive and active cooling techniques. Passive techniques pertain largely to the basic composition of the high power LED technology whereas active cooling techniques require additional power.

Passive Cooling Techniques

For some applications with mild environmental concerns, passive cooling techniques alone may be sufficient to address heat dissipation requirements. For more complex applications, oftentimes passive cooling techniques are combined with active cooling techniques to achieve desired results. Because they do not require additional power – passive cooling options are exhausted before implementing active cooling methods.

The four most commonly used passive cooling techniques are thermal paste, metal core PCBs (MCPCB), heat sinks and passive convection.

Thermal paste

Thermally conductive pastes are made with a specific chemical composition designed to reduce thermal resistance. Thermal pastes are applied between the high power LED and the PCB, increasing the surface area the LED-generated heat comes in contact with to the entire surface area of the PCB.

The four most commonly used types of thermal paste in order of least costly, to most costly are:

▪ Ceramic

Ceramic-based thermal paste is normally made of a ceramic powder suspended in a liquid silicone compound. The most commonly used are: beryllium oxide, aluminum nitride, aluminum oxide, zinc oxide, and silicon dioxide. These are the most ineffective, yet most cost effective option.

▪ Metal based

This type of paste is filled with metal particulate matter, typically silver or aluminum and has better conductivity than ceramic paste.

▪ Carbon based

Carbon fibers or diamond powder make up the carbon based thermal conductors and are considered the most efficient thermal paste

▪ Liquid metal based

Some thermal pastes have exotic metals in them, like gallium. These options are not as effective as the carbon based varieties, but also tend to be a bit pricier as the exotic metals can be quite cost prohibitive.

Metal core PCB (MCPCB)

Using a metal core PCB board is another passive cooling technique for controlling junction temperature. Metal core PCBs can dissipate heat more efficiently than the FR4 PCBs used in many general electronics applications because materials in metal core PCB has better thermal conductivity than materials in FR4 PCBs.

Commonly used metal core PCBs include aluminum and copper alloy. Copper has better heat conductivity than aluminum, however, copper is heavier and higher cost than aluminum, making aluminum the most popular metal core PCB substrate for high power LED applications

Heat Sinks

Heat sinks are a commonly used passive cooling technology that help conduct heat away from the LED die. Their primary task is to create more surface area to be cooled by convection and radiation. Having a larger surface area can help reduce heat more effectively. So by adding fins in the heat sink not only helps add surface area, but also helps cool the heat sink.

Heat sink performance usually is specified in terms of thermal resistance (Q):

$$Q_s = \frac{T_s - T_a}{Q}$$

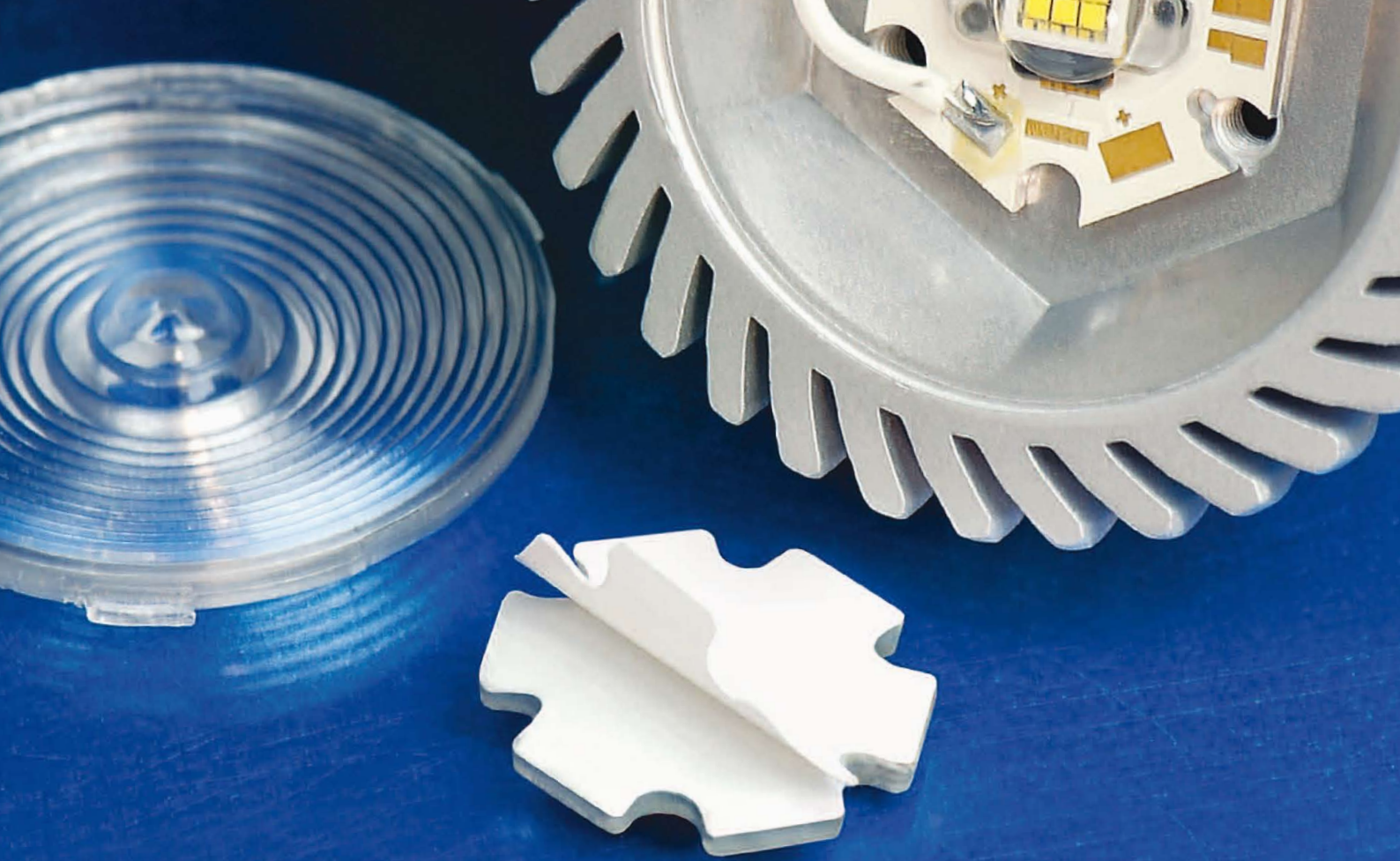

NEW T-CLAD® PA SIMPLIFIES ASSEMBLY.

Peel & place thermal solution withstands the heat of solder reflow.



Thermally conductive insulated metal substrate boards specifically configured for LED applications.

Easier assembly, cooler LEDs.

Bergquist's T-Clad with pre-applied Bond-Ply®450 allows you to adhere your mounted LEDs to a variety of heatsinks and surfaces while thermally optimizing your application. This version of peel and place T-Clad can withstand the high temperatures of solder reflow during LED assembly and then be positioned in the lighting application using its strong thermally conductive adhesive.

Call **+31 35 538 0684** or visit **www.bergquistcompany.com/TCladPA**



Bramenburg 9a, 3755 BT Eemnes • The Netherlands • www.bergquistcompany.com
Tel +31 35 538 0684 • Fax +31 35 538 0295 • Email: info@bergquist-europe.com

Thermal Materials • Thermal Substrates • Fans and Blowers

where:

- Q_s = Thermal Resistance in Degrees C per Watt
- T_s = Heat Sink Temperature in Degrees C
- T_a = Ambient or Coolant Temperature in Degrees C
- Q = Heat Input to Heat Sink in Watts

Heat sinks are made from a variety of metal materials. The most commonly used material is aluminum which has a thermal conductivity of 205 W/mK. Copper and silver have far better thermal conductivity than aluminum, but are often cost prohibitive. There are some companies that are making heat sinks from a polymer base. This technology could be cost prohibitive, but also allows for the heat sink to be made from a material that is not electrically conductive. This feature could limit the chance of electrical shock in some applications.

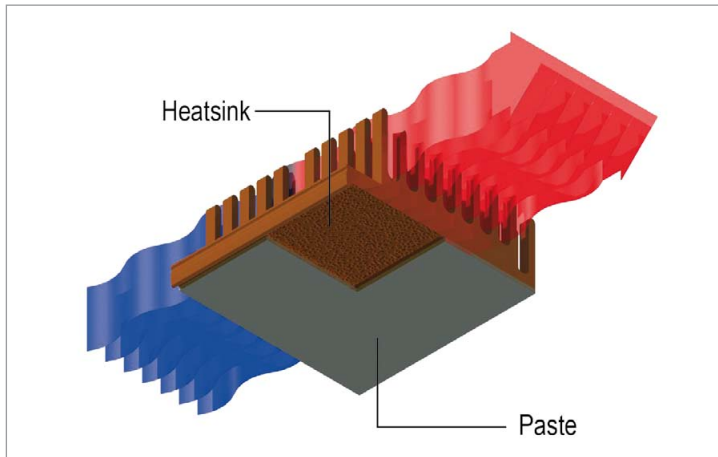

Figure 4: Passive cooling techniques: Heat sinks often have imperfections or small dips which can reduce surface area. Using a thermal paste helps increase surface area to fill in those dips and small holes. This helps transfer heat into the heat sink more effectively.

To examine how a heat sink radiates into the air, we need to refer back to the Stephan-Bolzman Law. Before we can use the equation, we need to add the constant, emissivity, to the equation (Emissivity is designated with the "ε" symbol). Emissivity is the adjustment to the black body that allows us to use the same equation for non-ideal heat absorption. For example, the emissivity for a black body = 1 and the emissivity for anodized aluminum is 0.77. T_n is the hot body temperature in Kelvin and T_c is the colder ambient temperature in Kelvin. A_c is the area of the emitting object. s is the Stefan-Boltzman constant. In an example of a rectangular heat sink emitting heat at a temperature 5°C less than the junction temperature of 40°C (the reason the temperature is not the same is due to thermal resistance of the path between the junction and the heat sink) and a 5mm square flat anodized aluminum heat sink you see the following set up in the equation:

$$\begin{aligned}
 q &= \epsilon \sigma (T_n^4 - T_c^4) A_c \\
 \epsilon &= 0.77 \\
 \sigma &= 5.6703 \times 10^{-8} \\
 T_n &= 288 \text{ K} \\
 T_c &= 273 \text{ K} \\
 A_c &= (0.005\text{m})^2
 \end{aligned}$$

It follows then that,

$$q = (0.77) (5.6703 \times 10^{-8}) (288^4 - 273^4) (0.005 \text{ m})^2 = 0.289 \text{ W}$$

The die used in making a 1 W white LED are generally about 30% efficient. The assumption is that of the 1 W of power in, the remaining 0.7 W will then be used in heat generation. This set up would radiate approximately 40% of all heat. Increasing the surface area of the heat sink would be the most direct way to improve this.

Passive Convection

Using a passive convection technique is the simplest way of transferring heat away from the heat sink. Natural air flow around the fins has a cooler temperature which in turn moves the heat away from the heat sink. This is a cost effective way on helping diffusing heat. A limitation with using just natural convection is that other components around the heat sink can increase the ambient temperature, which affects the overall thermal resistance of the heat sink.

Passive convection normally has a thermal resistance that's often more than 10C/watt. Improving passive convection means creating a better airflow towards the heat sink. Also creating more aerodynamic heat sink fins will help to improve airflow. Doing so will extract more heat, therefore optimizing the thermal resistance.

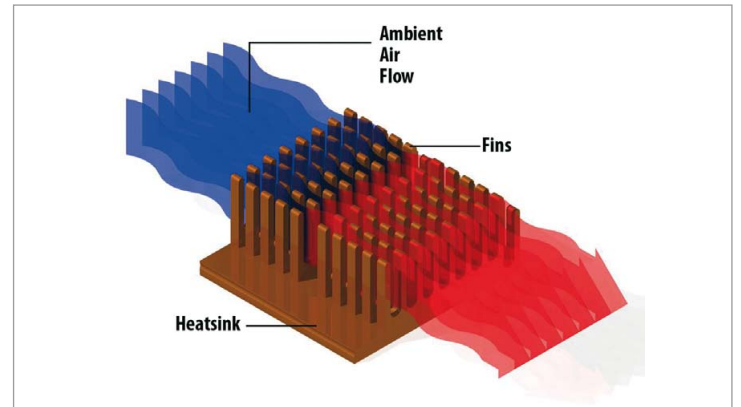

Figure 5: Passive Convection: Uses ambient air to flow in-between the heat sink fins. The heat sink transfers the heat from the metal fins to the passing ambient air. This in turn lowers the heat sink thermal resistance.

Active Cooling Techniques

Active cooling techniques require additional power input. Three of the most common active cooling techniques include fans, water cooling, and thermoelectric cooling.

Fans

Fans use active convection to dramatically change the ambient temperature by forcing air into the environment. Using a fan on top of a heat sink brings in air from a distance and actively pushes it across the heat sink fins. This has a far better performance than passive convection. A typical setup can reduce thermal resistance to 0.5°C/watt, which is far better than the 10°C/watt typically achieved with passive convection. To identify the right fan for a particular application, a velocity to volume conversion is needed. (Since air flow is stated in velocity and fans are rated in terms of volume)

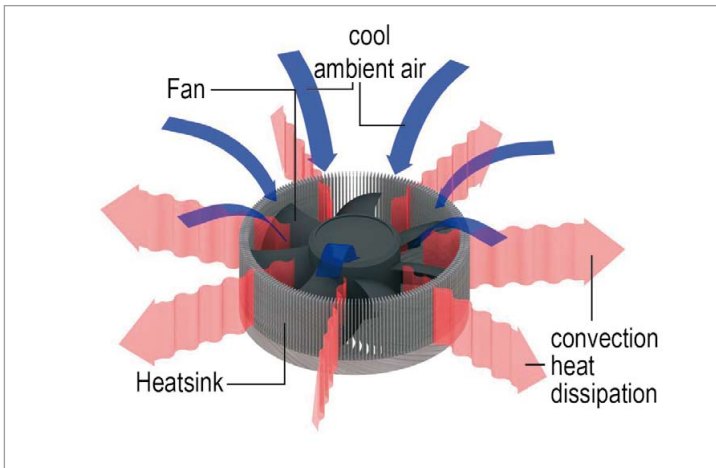

Figure 6: Fan and Heat Sink The fan will force ambient air into the heat sink creating a much greater force in cooling off the fins.

Velocity = Volume/Cross-sectional Area of Air Passage

Or: Linear Feet per Minute = Cubic Feet per Minute/
Area in Square Feet

Or: Linear Meters per Minute = cubic Meters per Minute/
Area in Square Meters

Water cooling

Water cooling is another active cooling technique that relies on active convection. Instead of using air gases for heat removal as is done in a fan, the gas is replaced with a liquid. This is a more efficient, but a significantly more expensive active convection technique since additional components are needed. There are three main components in a water cooling system; the heat sink, pump, and radiator (heat exchanger). Moving fluid is used to absorb the heat from the heat sink and carry it away from the heat source and back into the heat exchanger which is cooled by ambient temperature. A normal water cooling solution has a thermal resistance of 0.01 to 0.1°C/watt.

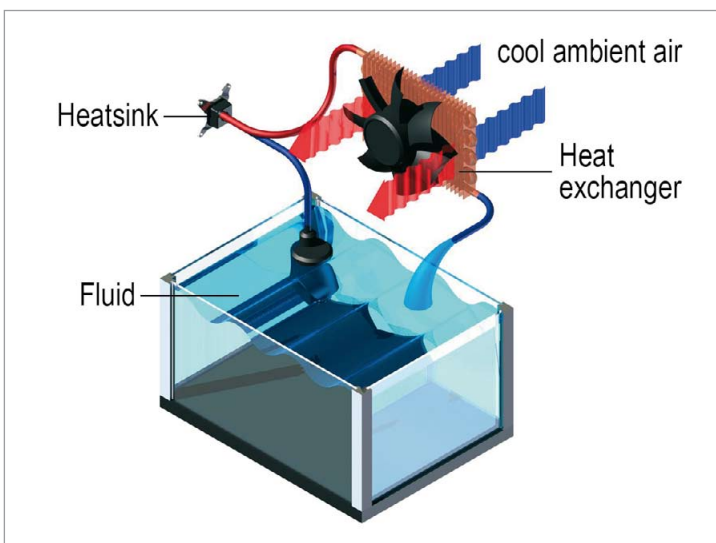

Figure 7: Water Cooling: instead of using air as convection, using fluid like water can transfer heat into the ambient air.

Thermoelectric cooling

A thermoelectric cooler is a solid state device that uses the Peltier Effect. Simply put, the Peltier Effect is the conversion of the temperature differences to an electric voltage and the other way around. A solid state version of the device uses P-type and N-type semiconductors sandwiched between the 2 plates. This setup will alternate charge flow to transfer the heat creating a temperature difference in which heat transfers from one side of the plate to another. The effect can be for both cooling and heating depending on the polarity of the voltage applied to the unit. Adequate ambient temperature is still needed to create an efficient cooler.

We can see the effect in action using the following example. A typical heat transfer of from hot to cool side is around 70°C @ 0 watts. This means if the unit is radiating 5 watts of heat, the Peltier device will transfer up to 65°C across its plates. This technique has several noteworthy disadvantages including energy consumption, heat generation and inefficiency.

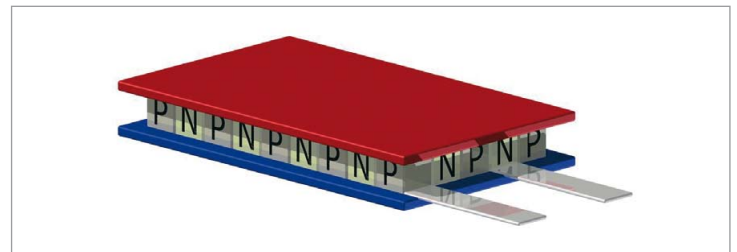

Figure 8: Structure of a thermoelectric cooler.

Both active and passive cooling techniques can play a critical role in thermal management of the junction temperature. Whether using some of the less expensive passive solutions like thermal paste or some of the higher impact and more costly solutions like water cooling, both types of cooling will make a significant difference in the efficacy, life hours and color integrity of your LED solution.

Conclusion

Management of junction temperature is critical to ensuring consistent high power LED performance. In the crowded high-power LED supplier market, make sure to identify a supplier who can provide a wide range of services – from simple off-the-shelf LED technologies to assisting in the design of comprehensive integrated technologies with optimized heat dissipation.

A quality supplier will provide both large and small customers with expert design support on a variety of active and passive cooling techniques designed to minimize junction temperature. They will also be able to integrate high power LED technology and any needed cooling techniques with LCDs, light pipes, switches, connectors and other key components to create solutions that maximize performance and efficiency in each individual application.

A supplier with this level of design expertise will be best suited to meet your evolving needs in this dynamic, growing market. ■

Drivers

Ballasts and Drivers for Conventional and Solid State Light Sources

> J. Lester, Consultant; W. Kaiser, Depto. Engenharia de Energia e Automação Elétricas, Escola Politécnica da Universidade de Sao Paulo; A. El-Deib and F. Dawson, Electrical and Computer Engineering Dept., University of Toronto;
Re-publication from the 12th Light Source & 3rd White LED Conference 2010

General

Lighting ballasts and drivers have changed over the years as electronic components developed. Initially most lighting circuits were based on inductors, transformers, and capacitors and operated at line frequencies. These circuits tended to be large, heavy, and not very efficient. They had the advantages of reliability, low cost, and were largely environmentally insensitive. Cost, reliability, and environmental sensitivity were the main weaknesses of early electronic lighting circuits. Electronic circuits were developed in the 1950s and 1960s but did not begin to see common lighting use until the 1970s when the electronic components evolved to more acceptable levels. Today, operating costs and government regulations effectively ban the old magnetic circuits for general lighting.

The following factors, to name a few, impact the design of ballast and driver circuits for lamps:

- Low cost – There is plenty of competition in the ballast field. Sales margins are low. Every US\$0.01 is important especially when a company sells many millions of ballasts a month.
- Simple – This keeps design time short and product costs low.
- Reliable – The cost to replace a ballast under warranty is much higher than the profit made by the sale of the ballast. Parts count is minimized to increase reliability. Ballast companies work hard to keep their customers happy.
- Small – Available ballast space in fixtures keeps shrinking. Also shipping costs are lowered.
- Performance – There are requirements for input power factor, efficiency, input voltage range, compliance, electromagnetic immunity (EMI) and safety.

Fluorescent Lamps

The initial concept of a fluorescent lamp evolved over nearly a 100 year period from the mid 1800s to the first lamps in production in 1938 [1]. High frequency ballasts for fluorescent lamps were suggested in the 1950s but reliable ballasts only started to sell well in the 1980s. Fluorescent lamps and ballasts work together as a system. It is possible to change one or the other to optimize the system. Lamp and ballast engineers should work together when a new lamp is being developed. In order to design a fluorescent lamp ballast, one needs to understand the basic properties of the lamp.

Lamp properties

The lamp voltage depends on many parameters such as the mercury vapour pressure, inert fill gas composition and pressure, lamp diameter, and lamp length. The lamp's starting and operating voltages can be somewhat independently controlled by adjusting these variables [2]. The lamp designer can lower the starting voltage if this will lower ballast cost and therefore system cost for example.

The amount of mercury vapour in the lamp controls the generated light efficiency. When designing a ballast, it is necessary to control the lamp's mercury vapour pressure. This can be done with a cold spot temperature controller. The temperature where the light production efficiency is highest for a simple mercury lamp is near 40°C.

Some lamps must be operated at higher temperatures due to small fixtures or high lamp powers. These lamps use an amalgam of mercury and other metals. They will typically have two lumen peaks; one near 70°C and one near 110°C depending on the amalgam materials used. Amalgams are usually located in an exhaust tube.

Lamp efficacy, LPW (lumens per watt), increases as ballast frequency increases due to the following two primary reasons. Firstly, anode oscillations disappear as the operating frequency increases. Secondly, at low operating frequencies the ionization of the mercury gas dissipates when the arc current goes through a zero crossing so some energy has to be put into the discharge to re-ionize the mercury every half cycle of the line voltage. At operating frequencies above the ionization frequency, the gas stays ionized through the zero crossings. LPW can increase 15% if the lamp's operating frequency is well above the ionization frequency of the discharge. Several parameters impact the discharge's ionization frequency but of interest to ballast designers is the lamp's diameter. The ionization frequency decreases as the square of the lamp's diameter [2].

Fluorescent ballasts

Figure 1 shows a typical block diagram of the ballast for general lighting lamps. The power line connects to the Electromagnetic Interference (EMI) filter which may take up to ¼ of the area within the ballast. All electronic ballasts will have an EMI filter to satisfy government regulations.

Technical Seminar & Product Workshop

Powering the lighting revolution

November 10, 2010 – 2:15 to 4:30 PM - Munich, Germany
electronica Exhibition Center Hall 1, Room A11/A12

“Effective lighting systems can only be developed through a systems approach, as efficacy and lifetime are dependent upon how well the components work together. See in two hours how to do exactly that for selected applications.”

 **electronica** 2010
components | systems | applications
RECOM Fair Booth: B2.213

✓ Introduction – Overview

✓ How High Power LEDs can make a difference

by Kai Klimkiewicz, CREE Europe

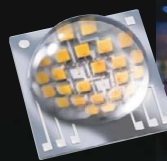

✓ Constant current driver modules

by Steve Roberts, RECOM Electronic GmbH

✓ Thermal management

by Prof. Dr. von Hoffmann
and Dipl. Ing. (FH) Felix Basel -
STC Applied Lighting Technology



✓ The complete solution

by Meinolf Gerber, Arrow Electronics

Following: an optional

✓ Product Workshop (open end)

Register at: www.recom-electronic.com/led

Sponsored by:



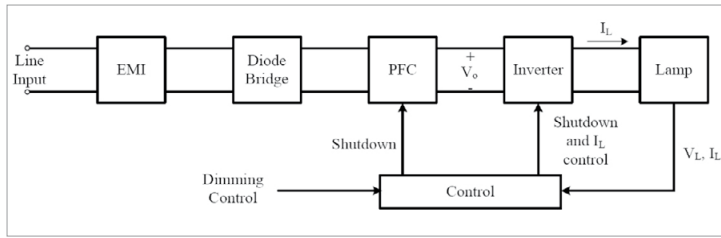

Figure 1: A typical block diagram of the ballast for general lighting lamps.

The output voltage of this filter is rectified and converted to a pulsing DC voltage and then fed into a Power Factor Correction (PFC) stage. The PFC stage shapes the current waveform on the power line to appear as a sine wave. Power companies often charge more for their electricity when the ballast input current waveform is poor. Low wattage screw-in compact fluorescent lamps usually do not have a PFC stage in order to minimize cost.

The output of the PFC stage is a regulated DC voltage, V_o , that is fed to a DC voltage to AC current inverter stage to feed the lamp. A control circuit may or may not be present. The control circuit may monitor the lamp and shut down the ballast for an end of life (EOL) condition [3], a no-start condition, or may regulate the lamp's current. It may also provide dimming control, or external digital interface control with a lighting control system. It can also be used to sequence the inverter from the start mode to the run mode in sequence start ballasts. There are two common electronic ballast circuits in use today. These are discussed next.

Current fed parallel resonant ballast

Figure 2 shows the circuit of the current fed parallel resonant ballast. The two switches are on alternately and power a resonant circuit comprised of L_1 and C_1 . The switching pattern causes a sine wave voltage to appear across C_1 . That voltage is often stepped up to 600 to 1,200 V by the circuit's transformer. Capacitor C_2 represents a high impedance that limits the current delivered to the lamp. The lamp's impedance is much lower than that of C_2 so that the inverter delivers essentially constant current, I_L to the lamp. In this example, the lamp is instant started by the high voltage appearing at the output of the transformer. The transformer also provides electrical isolation from the power line. This simple, low-cost circuit is used for cold cathode lamps in backlighting applications and has been popular for years ballasting T8 and T12 lamps [4, 5, 6].

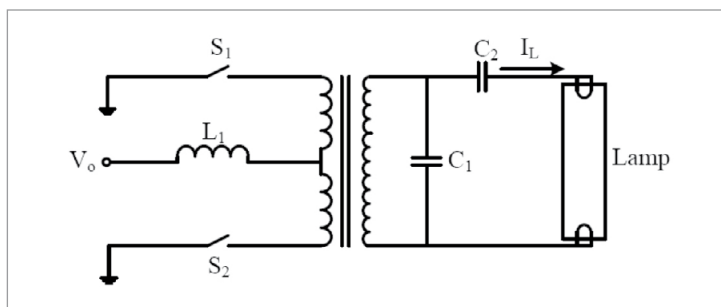

Figure 2: Circuit diagram of a current fed parallel resonant ballast.

Voltage fed series resonant ballast

Figure 3 shows the circuit of the voltage fed series resonant ballast. This is probably the most popular ballast used today and has been analyzed by many [5-12]. It is used in 90% of the popular screw-in compact fluorescent lamps, many T4, T5, T8, and T12 ballasts and most of the electrodeless lamp ballasts on the market. There is nearly an infinite combination of L_1 , C_1 , and C_2 that can be selected to give the desired current to the lamp. There is one combination however that is optimal as discussed below. The two switches are on alternately feeding a square wave to inductor L_1 . A control circuit can be used to drive the switches or feedback can be used to make the circuit self oscillate. The driving square wave can be modelled as a series of decreasing amplitude sine waves through Fourier analysis. The harmonics only contribute 8.8% to the RMS value of the square wave. Inductor L_1 and capacitors C_1 and C_2 form a second order filter that blocks the harmonics from reaching the lamp current I_L so the contribution of the harmonics to the lamp's current can be neglected. Therefore source voltage, V_s , driving L_1 can be modelled as a sine wave with the fundamental frequency.

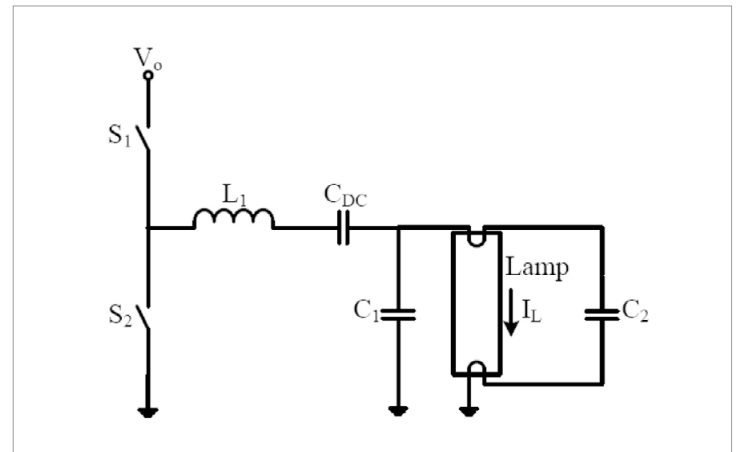

Figure 3: Circuit diagram of a voltage fed series resonant ballast.

If this circuit is operated at the resonant frequency F_o of L_1 and the equivalent capacitance C_{eq} of C_1 and C_2 , the current delivered to the lamp is constant and independent of the lamp load. When the lamp is off, the load on V_s is a series resonant circuit which at F_o is a short circuit. High current circulates in the circuit and a high voltage is generated across L_1 and C_{eq} . The high voltage across C_{eq} ignites the lamp. It can start and power an arc discharge lamp without control circuitry and steps up the voltage from V_s through resonant action. This boosting can be typically 3 to 5 times V_s depending on the loss in the resonant loop.

The power conversion efficiency of this ballast depends on the ratio Q of the lamp voltage to the source voltage V_s . This circuit works best with higher voltage lamps where Q is larger than one, which is often the case. The operating frequency, based on the resonance of LC, is always greater than the natural resonant frequency of the total RLC circuit causing the switches to turn on under zero voltage conditions thereby reducing the switching loss. If the operating frequency drops

3rd **LED/OLED** Lighting Technology Expo

LIGHTING JAPAN

Dates : **January 19** [Wed] - **21** [Fri], 2011

Venue : Tokyo Big Sight, Japan

Organised by : Reed Exhibitions Japan Ltd.

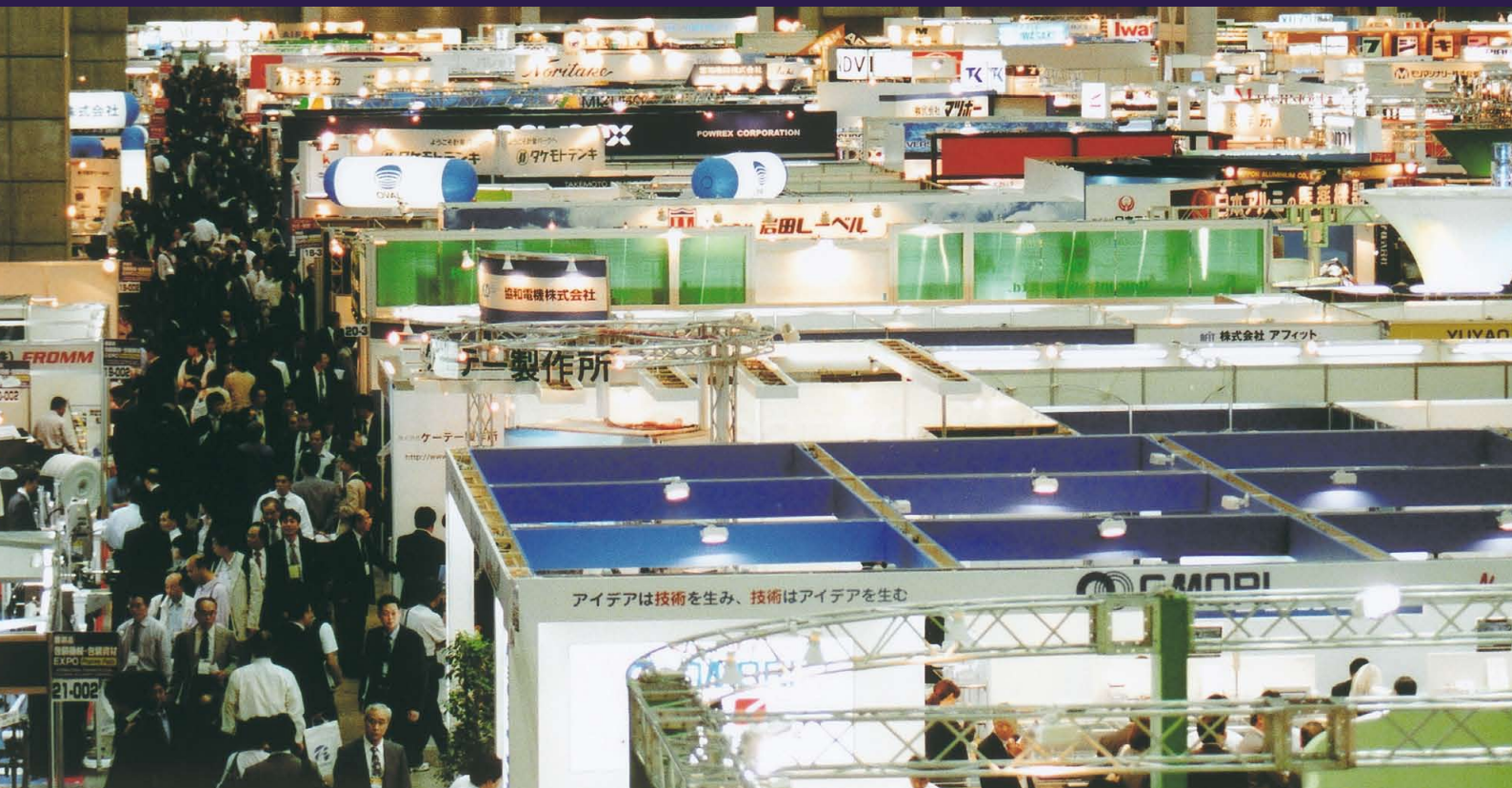

Concurrent Shows

NEPCON
JAPAN



ELECTRONIX
R&D JAPAN



AUTOMOTIVE
ELECTRONICS EXPO

International Show for LED/OLED Lighting Technology

500* exhibitors and 30,000* visitors will gather together!
Best place to expand your business and network!



(* expected)

For more information ▶▶▶ www.lightingjapan.jp/en/

Organised by

 Reed Exhibitions

LIGHTING JAPAN Show Management, Reed Exhibitions Japan Ltd.
18F Shinjuku-Nomura Bldg., 1-26-2 Nishishinjuku, Shinjuku-ku, Tokyo 163-0570, JAPAN
TEL: +81-3-3349-8568 FAX: +81-3-3349-0598 E-mail: light@reedexpo.co.jp

below the natural RLC frequency, the switches will be driving a capacitive load with associated high current spikes. This should be avoided during all phases of the lamp's operation.

High Intensity Discharge (HID) Lamps

The acronym HID (High-Intensity Discharge) designates three types of high-pressure (near or above 100 kPa), discharge lamps: mercury vapour, metal halide and sodium. The light-producing element of these lamp types is a well-stabilized arc discharge contained within a refractory envelope (a translucent or transparent fused quartz or alumina arc tube) with wall loading in excess of 3 W/cm². The electrodes consist of a high fusion point metal support coated with an electron emissive material. The high operating temperature and pressure require an outer enclosure to provide thermal isolation and protect users from the rupture of the arc tube. The space within the two enclosures is evacuated and may contain a getter to absorb residual contaminants.

High-pressure discharge lamp operation issues

The starting voltage specifications to initiate the electrical discharge (plasma) in high-pressure lamps are much higher than those for low-pressure lamps. Moreover, the voltage required to force ignition depends on the initial temperature inside the discharge tube. That is the reason why it is much more difficult to initiate a discharge in a lamp that was initially operational and was turned off momentarily (for example during a power outage) and then turned on again – an event called “hot strike ignition voltage”. This voltage is in the range of tens of kilovolts. There is no economic approach to address this issue and the majority of manufacturers recommend that the lamp be allowed to cool down for a specific period of time before ignition is reattempted.

The use of an electronic ballast for HID lamps faces a further problem namely the acoustic resonance phenomenon. The common explanation of the physical background for the acoustic resonance phenomenon is that when a HID lamp is operated with periodic power, the current is modulated and the intensity of the discharge and therefore the pressure of the filling gas inside the arc tube changes with the same frequency as the power. The fluctuation of the pressure, which originates in the vicinity of the discharge, propagates through the gaseous medium inside the arc tube.

Based on the theory of acoustic streaming, the physical causes of acoustic instabilities have been proposed. If the power frequency is at or close to an eigen-frequency of the arc discharge tube, travelling pressure waves will appear and distort the arc discharge path [13-16]. These waves reflect against the discharge tube walls and at certain frequencies standing pressure waves, called acoustic resonance, occur. Acoustic resonance with sufficient acoustic energy may cause undesired effects in HID lamps. Such effects range from a nearly imperceptible arc movement to extreme displacement of the discharge causing flicker, lamp voltage rise and even cracking of the discharge

tube [17]. The critical frequency values depend on distance between electrodes, tube geometry and gas composition and pressure. Also, lamp aging leads to changes in lamp resonant frequencies since filling gases and lamp electrodes change with time.

HID lamp ballast

The traditional AC mains frequency ballasts are electromagnetic devices with built in igniter that limit the current flow to the lamp but do not change the frequency of the input power. Electronic ballasts usually change the frequency of the power from the standard mains frequency to a higher value. The basic idea of most ballasts is to reduce the power harmonics below the acoustic resonance excitation threshold. According to the output current frequency, the HID electronic ballasts can be classified in four categories [18]. Some manufacturers [19-21] suggest DC operation for small wattage metal halide lamps. The electronic ballast in this case is a constant output current chopper with an external igniter.

A ballast with a low frequency square-wave output should ideally be a current source that produces only a dc power component and thus cannot excite acoustic resonance phenomena. In practice, a square wave current source is impossible to achieve and a trapezoidal waveform with fast rise and fall times is produced instead. The first significant power harmonic occurs at twice the operating frequency that lies below the lowest first order acoustic resonant mode and whose energy is below the threshold level value that can excite an acoustic resonance. Practical designs impose converter output frequencies between 200 and 400 Hz with the lowest order power harmonic frequencies between 400 and 800 Hz. Due to the topology of electronic ballasts for such an application, there is a high frequency ripple in the current or voltage waveform. The ripple content with sufficient energy at the proper frequency is able to excite acoustic resonance in HID lamps [22]. The threshold value for high frequency ripples that excites an acoustic mode and destabilizes the lamp is still an open question for the industry and standard organizations [23].

High frequency (HF) ballasts need some strategies to make them resistant to acoustic resonance. Several lamp supply strategies are found in the literature:

- Establishing HF operation in a free acoustic resonance zone [24]. The tuning process requires the predetermination of free acoustic resonance zones that depends on lamp model and is affected by lamp aging;
- Adopting adequate modulation strategies.

There are several papers in the literature describing different approaches: Injection of a white noise component along with the main switching frequency, spreading the input energy over a wide spectrum so as to minimize the magnitude of the input energy in a certain frequency range [25]; Using random switching schemes with amplitude limitation of each power harmonic, maintaining constant total power delivered to the lamp [26]; Injection of approaching frequencies signals confined within a selective band to avoid acoustic resonance under high frequency conditions [27].

The Very High Frequency (VHF) ballasts operate in the MHz range where acoustic resonance is not detectable. There are some papers in the literature reporting ballasts operating resonance free under these conditions [28-30].

One or more of the following factors motivates the move towards electronic ballasts: decreasing the ballast weight and volume, dimming feature, lumen maintenance over lamp lifetime by power regulation which can also counter the effect of arc voltage changing with lamp life and ballast shut down at lamp failure.

HID lamp ballast architectures

The literature contains a variety of HID lamp electronic ballast topologies with more or less complexity. Table 1 summarizes the general approaches for high pressure lamp ballasts although there are small differences between various HID lamp types.

Type 1 ballast has a resonant full-bridge inverter with an external igniter. A capacitor prevents a DC component in the lamp and the inductor limits lamp current. The lamp is shunted by an LC filter that ensures that high frequencies bypass the lamp. Type 1 ballast with internal resonant igniter has a half bridge LCC [31] inverter designed to operate at two frequencies. Prior to ignition, the lamp appears as an open circuit and the operating frequency is adjusted to ensure ignition. Current is sensed in the lamp and is used in a feedback system to maintain constant power through the lamp. After ignition, the impedance of the lamp drops and the switching frequency is adjusted to maintain a specific lamp power.

Type 2 ballast has an asymmetrical bridge LCC inverter and its operation is quite similar to those described under the type 1 ballast category with internal igniter.

Type 3 ballast uses a controlled current source that is inverted to produce the low frequency square wave AC current. The external igniter normally uses a SIDAC. The SIDAC behaviour is similar to an avalanche diode: below a certain threshold voltage the device is an open circuit and above the threshold voltage, the SIDAC breaks down and provides a low impedance path for the previously charged capacitor.

Light Emitting Diode (LED) Lamps

The light emitting diodes (LEDs) are attractive light sources due to their high efficiency, long life time and low maintenance requirements. One of the main obstacles facing the LED as a light source is the degradation of its optical output due to the increase of the junction temperature. The temperature increase is the result of the conduction losses in the LED. The junction temperature also affects the wavelength produced by the LED and therefore the light colour generated also depends on the junction temperature. A 10°C change in the junction temperature results in a change in the colour point of $\Delta uv=0.005$, as noted in [39]. Therefore different control techniques have been proposed to stabilize the colour produced by the LED [32, 33, 34].

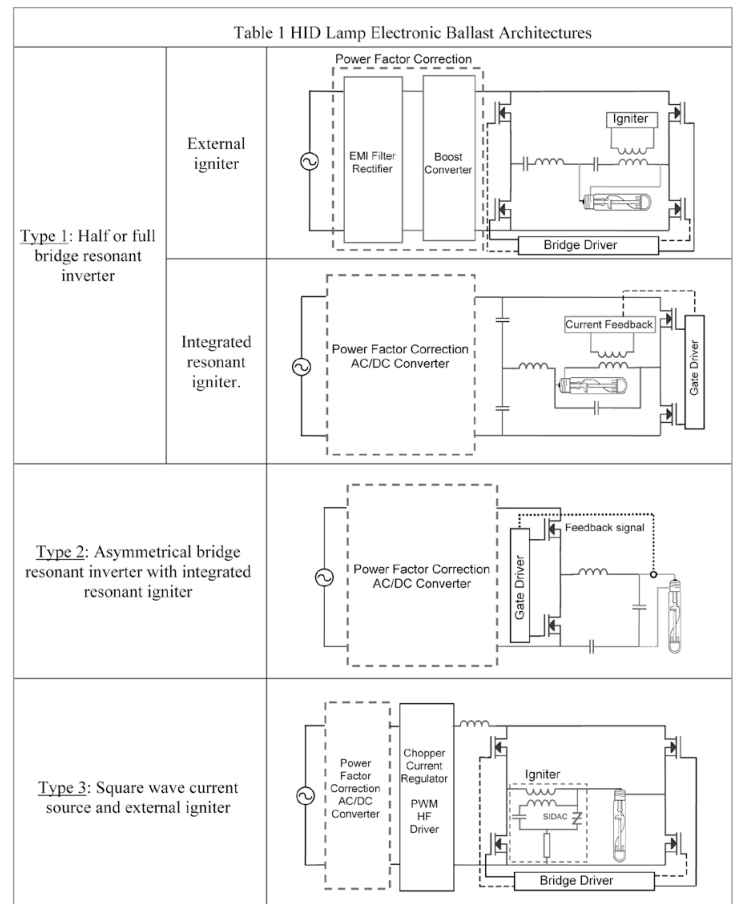

Table 1: The main HID lamp electronic ballast architectures are presented.

Effect of the input current waveform

The luminous flux and colour produced by the LED are related to the instantaneous value of the input current. Therefore if LED dimming is required, the LED performance in terms of efficacy and colour will change. The current waveforms suggested in the literature include the following:

Constant current

Constant current with an imposed ripple of a specific frequency and amplitude

Pulsed width modulated (PWM) current with controlled duty cycle, frequency and peak current.

In [35], a comparison was performed between the previously mentioned current waveforms in terms of the LED efficacy. The result of this experimental study indicates that the pure DC current produces the highest efficacy over the whole dimming range. The DC current with linear ripple produced efficacies which are very close to the DC current when the ripple percentage was under 20% of the average current.

The PWM pulsed current waveform achieves the same efficacy as the DC current at high values of duty ratio corresponding to high output luminous flux. The PWM current produces a constant efficacy over the whole range of duty ratios.

The LED manufacturers always produce their datasheets based on a pure DC current fed to the LED which gives the best performance. However, for the power electronics driver it is too expensive to design a driver that can produce pure DC current waveform because lower ripple requires larger energy storage elements impacting the power density and cost of the system. Therefore, the selection of the current waveform to be used should be based on maximizing the efficiency of the whole system, increasing the power density and satisfying the required lifetime with the minimum cost.

LED lamp driver architectures

The LED should be operated as a current driven device because the optical output of the LED is determined by the input current. There have been many approaches suggested in the literature to supply this current. The drivers for LED applications can be categorized as belonging to one of the following two main types; non-isolated drivers and isolated drivers [36].

Non-isolated drivers do not contain galvanic isolation and therefore this category is suitable for battery connected LEDs, for example, emergency lighting systems. On the other hand, the isolated drivers include a transformer that performs the required galvanic isolation for powering from the AC grid. The isolated drivers are preferably operated at high switching frequencies to minimize the size of the transformer used for isolation. Also, isolated drivers must be connected to the AC mains through a power factor correction circuit (PFC) to comply with the power factor and the total harmonic distortion (THD) requirements.

The non-isolated drivers that have been suggested include most of the conventional DC-DC converters like Buck [33], Boost [40], Buck-boost [42] and Cuk [41] converters. A block diagram for these drivers is given in table 2. There are many options for LED drivers because the choice of the suitable driver depends on matching the input power source and the requirements of the LED as a load. If the power source is the AC mains, the input voltage has to be stepped down to the required voltage level of the LED string. In the case of stepping down the voltage level, the Buck converter is the suitable driver but for battery systems it might be required to step up the voltage therefore the Boost converter would be the better choice.

The main issue with these conventional converters is the presence of the electrolytic capacitor at the output. This electrolytic capacitor has a short life time compared to the LED lifetime. Therefore the electrolytic capacitor has to be oversized to meet the required lifetime of the system. Another disadvantage of having an electrolytic capacitor is its large size and therefore the power density of the driver will be low which is not permitted in some applications like the backlighting of LCD screens. Yet, another factor that should be considered in the design of the LED driver is the cost as it should be minimized as much as possible to maintain the advantage of a low cost lighting system.

The flyback converter is an example of an isolated driver that was proposed in [31], [36] and [37]. As discussed above, pulsed current waveforms can also be used to drive the LEDs. The flyback converter can be operated without a capacitor at the output to produce current pulses in the LED load. This allows for direct control of the LED current without adding a series sense resistance to the circuit. Another isolated converter that can directly control the LED current is the series resonant converter as suggested in [36] and [38]. The load current in the series resonant converter has the shape of sinusoidal pulses and the average current of these pulses can be controlled by the switching frequency. The block diagram for the isolated drivers is also shown in table 2.

A different concept for driving a number of LED strings is to use a multilevel converter which includes a main DC bus and a number of capacitors connected in series [39]. Each of these capacitors feeds a modular driver that supplies current to an LED string. The advantage of this approach is to have individual control over the different LED strings. Instead of connecting all the LEDs in series they are divided into strings and each string is driven by a separate driver to increase the system's reliability. Also this configuration can be used in the RGB LED systems, where each LED group can be controlled independently to control the chromaticity coordinates of the produced light. A number of papers have investigated different methods for integrating the power factor correction PFC and the driver required to produce the current for the LED string in order to enhance the efficiency of the system and to minimize its cost.

Another topology was suggested in [43] where buck and flyback converters were integrated to drive the LEDs directly from the AC mains as shown in table 2. The buck converter performs the PFC and the flyback converter delivers the required current to the LEDs. Both converters are operated in DCM to provide the PFC action and fast output dynamics which is important to achieve dimming operation using the PWM approach. This integrated converter is capable of working under a wide range of input AC voltages however the efficiency of the converter has a maximum of 80% at an input voltage of about 150 V_{rms}.

Table 2 LED Lamp Electronic Driver Architectures	
Non isolated LED Driver (Buck, Boost, Buck-Boost, Cuk)	
Isolated LED Driver (Flyback, series resonant)	
Integrated LED Driver (Integrated Buck-Flyback)	

Table 2: LED lamp electronic driver architectures.



The World's Largest LED Event

LED CHINA 2011

1 - 4 March | China Import and Export Fair Pazhou Complex, Area B, Guangzhou

• 50,000 sqm of exhibition area • 800 exhibiting companies

• 60,000 domestic and overseas visitors

2011
Highlight

One-stop
sourcing

- LED Lighting
- LED Displays
- LED Illuminant
- LED Chips
- LED Packaging
- LED Backlight
- OLED, LD, EL, and others
- LED Manufacturing Equipments & Testing Instruments

The Green ideology, led by LED

Organiser : UBM Trust Co Ltd

Add : Rm 1306, Tian He Fu Li Business Mansion, No.4, Hua Ting Rd, Lin He Dong Rd, Tian He Bei District, Guangzhou, 510610, China

Tel : 86 20 3810 6261, 3810 6263 | Fax : 86 20 3810 6200 | Email : led-trust@ubm.com | Website: www.LEDChina-gz.com

Japan | Tel : 81 3 5296 1020 | Fax : 81 3 5296 1018 | Email : christopher.eve@ubm.com

Korea | Tel : 82 2 6715 5400 | Fax : 82 2 432 5885 | Email : sekyoo.oh@ubm.com

Taiwan | Tel : 886 2 2738 3898 / 2738 5598 | Fax: 886 2 2738 4886 | Email : info-tw@ubm.com

USA | Tel : 1 516 562 7855 | Fax : 1 516 562 7854 | Email : cecilia.wun@ubm.com





DC/DC LED Drivers for High-Current LED Lighting

New members of the Infineon® Power LED Driver family

The Infineon® Power LED Driver family has two new members. Both devices are DC/DC constant-current drivers especially designed to drive automotive LEDs in interior and exterior lighting systems.

- The TLD 5085EJ is a smart LED buck driver circuit that provides all active functions for a constant-current switching regulator, capable of delivering up to 1.8A load current with an integrated MOSFET.
- The TLD 5095EL is a smart LED boost controller with built-in protection and diagnostic features. The main function of this device is to boost the output voltage and regulate a constant LED current. The device comes with a status pin for diagnostics.

To learn more about the Infineon® Power LED Driver family, please visit www.infineon.com/automotive-leddrivers

Conclusions

The most popular ballasts and drivers for the conventional and solid state lamps have been reviewed in this paper. The technology for the conventional lamps ballasts has matured. On the other hand, the drivers for the solid state lamps still face a number of challenges and therefore most of the research efforts have been directed towards this area. The challenge still facing all types of light source ballasts is finding a sufficiently accurate model for the lamp that can be used in the design process of the ballast. This model should demonstrate the important features of the lamp under different operating conditions and concurrently be suitable for integration within simulation software packages used for the ballasts' design especially in terms of short simulation times. ■

Acknowledgements:

LED professional would like to thank the hosts of the 12th Light Source & 3rd WhiteLED Conference, and especially Prof. Dr. Zissis and the authors of this article for granting the re-publication.

References:

- [1] Inman G., "Electric Discharge Lamp", US Patent 2,259,040, Oct. 14, 1941
- [2] Waymouth J. F., "Electric Discharge Lamps", Cambridge, MA, MIT Press, 1978.
- [3] Lester J. N., "Fluorescent Lamp End-Of-Life Shutdown Sense Methods", *Journal of the Illuminating Engineering Society*, Vol. 31, No. 2, pp. 78-85, Summer, 2002
- [4] Bairanzade M., "Electronic Lamp Ballast Design", Motorola Application Note AN1543, 1995
- [5] Baxandall P. J., "Transistor Sine-Wave LC Oscillators", IEE (London) International Convention on Transistors and Associated Semiconductor Devices, pt. B, suppl. 16, May 1959, pp. 748-758
- [6] Chudobiak W. and Page D. F., "Frequency and Power Limitations of Class-D Transistor Amplifiers", *IEEE Journal of Solid-State Circuits*, Vol sc-4, No. 1, Feb. 1969, pp. 2537
- [7] Kaufman M. and Seidman A.H., *Handbook of Electronics Calculations*, McGraw-Hill, P7.1, 1979
- [8] Bairanzade M., "The Electronic Control of Fluorescent Lamps", Motorola Application Note AN1049, 1990
- [9] Kazimierzczuk M. K. and Szaraniec W., "Electronic Ballast for Fluorescent Lamps", *IEEE Transactions on Power Electronics*, Vol. 8, No. 4, Oct. 1993, pp. 386-395
- [10] El-Hamamsy S. A., "Design of High-Efficiency RFL-Class-D Power Amplifier", *IEEE Transactions on Power Electronics*, Vol. 9, No. 3, May 1994, pp. 297-308
- [11] Nilssen O. K., "Electronic Ballast Circuit for Fluorescent Lamps", US Patent 4,503,363, March 5, 1985
- [12] Nerone L. R., "A Mathematical Model of the Class D Converter for Compact Fluorescent Ballasts", *IEEE Transactions on Power Electronics*, Vol. 10, No. 6, Nov. 1995, pp. 708-715
- [13] F. Afshar, "The Theory of Acoustic Resonance and Acoustic Instability in HID Lamps", *LEUKOS*, vol 5, no.1, pp. 26-38, July 2008
- [14] H. Witting, "Acoustic resonances in cylindrical high-pressure arc discharges", *Journal of Applied Physics*, vol. 49, no.5, pp. 2680-2683, 1978
- [15] H. P. Stormberg, R. Schäfer, "Excitation of acoustic instabilities in discharge lamps with pulsed supply voltage", *Lighting Research & Technology*, vol. 15, no.3, pp.127-132, 1983
- [16] J. W. Dennen, "Acoustic resonances in high frequency operated low wattage metal halide lamps", *Philips Journal of Research*, vol. 38, no. 415, pp. 263 - 272, 1983
- [17] P. M. Morse, K. U. Ingard, *Theoretical Acoustics*, McGraw-Hill Book Company, 1968
- [18] M.W. Fellows, "A study of the high intensity discharge lamp-electronic ballast interface", *38th IAS Annual Meeting Conference Record*, vol. 2, pp. 1043 - 1048, 2003
- [19] J.M. Davenport, R. L. Hansler, "Direct current operation of low wattage metal halide lamps", *Journal of the Illuminating Engineering Society*, pp. 274-282, Oct. 1984
- [20] General Electric Co., "32W HALARC metal halide lamp application guidelines, HD-1502, Feb. 1987
- [21] R. J. Wood, "Low watt metal halide apparatus", U.S. patent 5 291 100, March 1994
- [22] F. Afshar, "Allowed Level of the Power Ripple in Low Frequency Square-Wave Ballasts of Metal-Halide Lamps", *LEUKOS*, vol 3, no.2, pp. 143-157, October 2006
- [23] J. Olsen, P. W. Moskowicz, "Detrimental effect of a small amount of ripple in a metal halide system", *40th IEEE IAS Annual Meeting Conference Records*, vol. 3, pp. 1581-1587, 2005
- [24] E. Rasch and E. Statnic, "Behavior of metal halide lamps with conventional and electronic ballasts", *Journal of the Illuminating Engineering Society*, pp. 88-96, summer 1991
- [25] L. Laskaj, P. N. Enjeji, I. J. Pitel, "White-noise modulation of high-frequency high-intensity discharge lamp ballasts", *IEEE Transactions on Industry Applications*, vol. 34, no. 3, pp. 597-605, 1998
- [26] W. Yan, Y.K.E Ho, S.Y.R Hui, "Stability study and control methods for small-wattage highintensity- discharge (HID) lamps", *IEEE Transactions on Industry Applications*, vol. 37, no. 5, pp. 1522-1530, Sept.-Oct. 2001
- [27] L. Chhun, P. Maussion, S. Bhosle, G. Zissis, O. Durrieu, "HPS lamp control by signal injection of approaching frequency to avoid acoustic resonances: Application to an LCC circuit", *13th European Conference on Power Electronics and Applications*, 2009
- [28] M. Gulko, S. Ben-Yaakov, "A MHz electronic ballast for automotive-type HID lamps", *IEEE Power Electronics Specialists Conference*, pp. 39-45, 1997
- [29] M. H. Ohmoto, Q. Mao, H. Ohguchi, T. Shimizu, G. Kimura, H. Takagi, "Megahertz operation of voltage-fed inverter for HID lamps using distributed constant line", *IEEE Transactions on Industry Applications*, vol.34, no. 4, pp. 747-751, 1998
- [30] R. Redl, J. D. Paul, "A new high frequency and high efficiency electronic ballast for HID Lamps: topology, analysis, design, and experimental results", *Proceedings of the IEEE Applied Electronics Conference*, vol.1, pp. 486-492, 1999
- [31] R.M. Nelms, T.D. Jones, M.C. Cosby Jr., "A comparison of resonant inverter topologies for HPS lamp ballasts", *28th IEEE IAS Annual Meeting Conference Records*, vol. 3, pp. 2317-2322, 1993
- [32] Muthu, S.; Schuurmans, F.J.P.; Pashley, M.D., "Red, green, and blue LEDs for white light illumination," *Selected Topics in Quantum Electronics, IEEE Journal of*, vol.8, no.2, pp.333-338, Mar/Apr 2002
- [33] Bernitz, F.; Schallmoser, O.; Sowa, W., "Advanced Electronic Driver for Power LEDs with Integrated Colour Management," *Industry Applications Conference, 2006. 41st IAS Annual Meeting. Conference Record of the 2006 IEEE*, vol.5, no., pp.2604-2607, 8-12 Oct. 2006
- [34] Ackermann, B.; Schulz, V.; Martiny, C.; Hilgers, A.; Zhu, X., "Control of LEDs," *Industry Applications Conference, 2006. 41st IAS Annual Meeting. Conference Record of the 2006 IEEE*, vol.5, no., pp.2608-2615, 8-12 Oct. 2006
- [35] Sauerlander, G.; Hente, D.; Radermacher, H.; Waffenschmidt, E.; Jacobs, J., "Driver Electronics for LEDs," *Industry Applications Conference, 2006. 41st IAS Annual Meeting. Conference Record of the 2006 IEEE*, vol.5, no., pp.2621-2626, 8-12 Oct. 2006
- [36] van der Broeck, Heinz; Sauerlander, Georg; Wendt, Matthias, "Power driver topologies and control schemes for LEDs," *Applied Power Electronics Conference, APEC 2007 - Twenty Second Annual IEEE*, vol., no., pp.1319-1325, Feb. 25 2007-March 1 2007
- [37] Yuequan Hu; Huber, L.; Jovanovic, M.M., "Single-Stage Flyback Power-Factor-Correction Front-End for HB LED Application," *Industry Applications Society Annual Meeting, 2009. IAS 2009*, pp.1-8, 4-8 Oct. 2009
- [38] Yu-Kang Lo; Kuan-Hung Wu; Kai-Jun Pai; Huang-Jen Chiu, "Design and Implementation of RGB LED Drivers for LCD Backlight Modules," *Industrial Electronics, IEEE Transactions on*, vol.56, no.12, pp.4862-4871, Dec. 2009
- [39] Qingcong Hu; Zane, R., "LED Drive Circuit with Series Input Connected Converter Cells Operating in Continuous Conduction Mode," *Applied Power Electronics Conference and Exposition, 2009. APEC 2009. Twenty-Fourth Annual IEEE*, vol., no., pp.1511-1517, 15-19 Feb. 2009
- [40] Chun-Yu Hsieh; Ke-Hong Chen, "Boost DC-DC converter with charge-recycling (CR) and fast reference tracking (FRT) techniques for high-efficiency and low-cost LED driver," *Solid-State Circuits Conference, 2008. ESSCIRC 2008. 34th European*, vol., no., pp.358-361, 15-19 Sept. 2008
- [41] de Britto, J.R.; Demian, A.E.; de Freitas, L.C.; Farias, V.J.; Coelho, E.A.A.; Vieira, J.B., "A proposal of Led Lamp Driver for universal input using Cuk converter," *Power Electronics Specialists Conference, 2008. PESC 2008. IEEE*, vol., no., pp.2640-2644, 15-19 June 2008
- [42] Jianwen Shao, "Single Stage Offline LED Driver," *Applied Power Electronics Conference and Exposition, 2009. APEC 2009. Twenty-Fourth Annual IEEE*, vol., no., pp.582-586, 15-19 Feb. 2009
- [43] Gacio, D.; Alonso, J.M.; Calleja, A.J.; Garcia, J.; Rico-Secades, M., "A Universal-Input Single-Stage High-Power-Factor Power Supply for HB-LEDs Based on Integrated Buck-Flyback Converter," *Applied Power Electronics Conference and Exposition, 2009. APEC 2009. Twenty-Fourth Annual IEEE*, pp.570-576, 15-19 Feb. 2009



Conference language:
German

8th VDI Conference

Innovative lighting with LEDs

24th - 25th November 2010, Düsseldorf, Germany

Conference highlights:

- From retrofitting to the integrated design of LED lighting
Prof. Dipl.-Ing. Andreas Schulz, CEO, LICHT KUNST LICHT AG
- LED light engines: the flexible light source of the future
Dipl.-Ing. Stefan Wallner, Product Manager, OSRAM GmbH
- The Zhaga Consortium: making LED light engines interchangeable
Dr. Menno Treffers, Secretary-General, Zhaga Consortium
- Innovative reflector designs for LED-based lights
Dipl.-Ing. Henning Schlüter, Managing Director & Partner, Alux Luxar GmbH & Co. KG
- Examples of applications:
 - Workplace lighting at the Federal Audit Office in Bonn
 - Light design using LEDs at the Schulzentrum in Trier
 - LEDs in operating theater luminaires and street lighting



- + Panel discussion with:
Bridgelux, Citizen Electronics, Nichia Chemical Europe, OSRAM Opto Semiconductors and Philips

Register now!
www.led-tagung.de

- + Workshop: Compact knowledge - LEDs in lighting
26th November 2010, Düsseldorf

Topics: Thermal management, color behavior, drivers and optics

Special Topics

CO₂ Balance Sheet: Aluminum Versus Alumina Ceramics

> Dr. Meinhard Kuntz, Manager Oxide Development, CeramTec AG

There are a number of advantages that result from the production of LED lamps using alumina ceramics as a material for heat sinks, reflectors or mountings. These range from excellent thermal management of the CeramCool system to electrical insulation, aesthetics and haptics. Ceramic can replace established technical solutions made from aluminum. The LCA or "ecobalance" with regard to the production of the product contributes to an objective evaluation of a possible large-scale substitution. This article offers an estimate of the CO₂ equivalents between aluminum and alumina ceramics of energy-relevant processing methods. Substituting aluminum with alumina ceramics reduces CO₂ emissions into our atmosphere by roughly a factor of two using a volume comparison. When you consider the weight of the end product, aluminum contributes about three times the amount of CO₂.



Figure 1: Bauxite raw material: The basis for the production of aluminum and ceramic (Credits: Geological collection, University of Tübingen, Dr. Udo Neumann).

Bauxite is a rock mainly comprising minerals that are various hydrous aluminum oxides (e.g. boehmite, gibbsite, diaspore) and typical impurities mainly of iron, silicon and titanium. In particular, the typical dark reddish brown color is a consequence of a significant iron content. This raw material is strip mined and serves as the basis for the production of aluminum metals and alumina ceramics. Using the Bayer process, a common method invented by Karl Josef Bayer in 1888, bauxite is mixed with a sodium hydroxide solution, finely ground

and heated with steam. The aluminum hydroxide dissolves, the impurities precipitate and are separated from the solution with filters (red mud). As the solution cools down, the purified aluminum hydroxide finally precipitates.

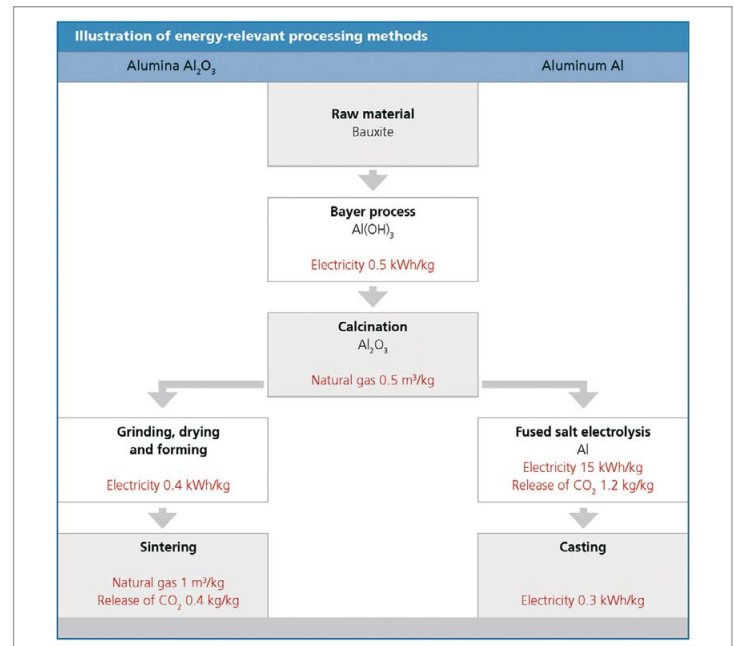

Figure 2: Overview of energy-relevant processing methods. - Several energy sources are used in this process. To increase clarity, all numerical values have been simplified and rounded.

The purification of the hydroxide requires around 0.5 kWh of electricity per kg of ceramic alumina powder, which develops through calcination. This is achieved by heating aluminum hydroxide to 1,200°C, which removes the water, converts the hydroxide into oxide and results in Al₂O₃. The calcination kilns are fired with natural gas, using roughly 0.5 m³ per kg of Al₂O₃. The manufacturing process for metallic aluminum and alumina ceramics is identical up to this point. Using stoichiometry, 530 g of aluminum is obtained from 1,000 g of Al₂O₃. For the CO₂ balance sheet this means that the energy consumption from the Bayer process is about twice as high for 1 kg of aluminum than for 1 kg of alumina ceramics. This fact is considered in the tabular overview of table 2 in the calculation by a factor of two.

The processes go different ways after calcination. By far, the most amount of energy is required for fused-salt electrolysis, during which metallic aluminum is obtained from the alumina powder. The melting temperature of Al₂O₃ is very high (approx. 2,200°C). It is thus necessary to mix the alumina powder with cryolite (Na₃AlF₆), which reduces the melting temperature down to approximately 950°C. At fused-salt electrolysis the aluminum metal is deposited at the cathode in the electrolytic cell. The anode consists of carbon blocks that decompose to CO₂ during the reaction. This process consumes 15 kWh of electrical energy and additionally directly releases 1.2 kg of CO₂ per kilogram of aluminum. Another important factor to consider in the ecobalance is the formation of harmful gases such as carbon monoxide and hydrogen fluoride. Aluminum takes shape when it is cast; the metal is melted at temperatures of around 700°C, which consumes comparatively little energy.



Figure 3: Sintering - Formed ceramic parts undergo heat treatment below the melting temperature; alumina Al_2O_3 , e.g. at 1300-1600 °C (air). Sintering uses the most energy of all process steps in the production of ceramic, yet the amount of CO_2 released is only half the amount released in aluminum production.

After calcination the ceramic powder is ground, dried and, depending on the production process, combined with 2-12% organic binding agents. Die casting is the preferred method for forming powder bodies in mass applications with complex geometries. Dry pressing is suitable for the large-scale production of less complex components. Electricity consumption of 0.4 kWh/kg was assumed together with grinding and drying in evaluating the production process. Sintering requires the most amount of energy in the production of ceramic components, consuming 1 m³/kg of natural gas. Moreover, approx. 0.4 kg of CO_2 is released for each kilogram of ceramic sintered as the organic binding agents are burned.

CO ₂ equivalents for various energy sources			
Energy source	Quantity	Unit	Total quantity CO ₂ equivalents*
Electricity	1.00	kWh	0.62 kg
Heating oil	1.00	l	3.12 kg
Natural gas	1.00	m ³	2.49 kg
Liquid gas	1.00	l	1.90 kg
Diesel	1.00	l	3.13 kg
Gasoline	1.00	l	2.92 kg
Wood pellets	1.00	kg	0.07 kg
Source: Bayerisches Landesamt für Umwelt, Infozentrum UmweltWirtschaft http://www.izu.bayern.de			*Including upstream process

Table 1: CO₂ equivalents of various energy sources, which were the basis for the calculations, are provided by the Bavarian State Office for Environment.

This concludes the process evaluation and energy estimates regarding the production of aluminum and alumina ceramic components. A tabular summary of all CO₂ relevant process steps provides a good overview here. Figures from the Bayerisches Landesamt für Umwelt, Infozentrum UmweltWirtschaft [Bavarian State Office for Environment, InfoCenter Environmental Economics] were used in

calculating the CO₂ equivalents of various energy sources. According to these figures, the production of 1kg of metallic aluminum creates roughly 13.5 kg of CO₂, as opposed to 4.8 kg for 1 kg ceramic alumina. When you consider the weight of the end product, aluminum contributes about three times the amount of CO₂.

Aluminum - Calculation of CO ₂ equivalents				
Process step	Energy source	Consumption	Factor	CO ₂ equivalent
Bayer process	(electricity)	0.5 kWh/kg	2	0.6
Calcination	Natural gas	0.5 m ³ /kg	2	2.5
Fused-salt electrolysis	Electricity	15 kWh/kg	1	9.0
Fused-salt electrolysis	Release of CO ₂	1.2 kg/kg	1	1.2
Casting	Electricity	0.3 kWh/kg	1	0.2
Total				13.5
Alumina Ceramics - Calculation of CO ₂ equivalents				
Process step	Energy source	Consumption	Factor	CO ₂ equivalent
Bayer process	(electricity)	0.5 kWh/kg	1	0.3
Calcination	Natural gas	0.5 m ³ /kg	1	1.3
Processing	Electricity	0.4 kWh/kg	1	0.3
Sintering	Natural gas	1 m ³ /kg	1	2.5
Sintering	Release of CO ₂	0.4 kg/kg	1	0.4
Total				4.8

Table 2: Calculation of CO₂ equivalents (for the significance of the factor see the notes on the Bayer process). When you consider the weight of the end product, aluminum contributes about three times the amount of CO₂.

The density of aluminum is 2.7 g/cm³; Al_2O_3 has a density of 3.9 g / cm³ (factor 1.44). Replaced by the same volume (Al_2O_3 : 4.8 kg CO₂ × 1.44 = 6.9 kg CO₂), the CO₂ balance is still significantly better for alumina ceramics than for aluminum. Using a rough estimate, substituting aluminum with alumina ceramics for a component of the same size reduces CO₂ emissions into our atmosphere by approximately a factor of two.

Whenever considering CO₂ we should ask the question at which point a comparison no longer makes sense. Right here, with the heat sink as the end product? One step further, after it has been populated with electronic components? Another step further, in its use, e.g. as a LED lamp which saves more energy with ceramic thanks to more efficient cooling for its service life of 15,000 or even 40,000 hours? There are too many imponderables to be able to provide a single simplification. What appears to be more interesting and calculable, however, is the final stage – disposal or recycling. Metallic aluminum in part can be partly reused through recycling; in contrast, a sintered ceramic component cannot be reused in the production of ceramics. Yet ceramic is absolutely chemically stable and entirely neutral for the environment. Disposal is not critical; worn-out ceramic components are used, among other things, as a filling material in road construction. With metallic aluminum, on the other hand, metal ions can be released into the groundwater under unfavorable conditions. Also considering the harmful products from fused-salt electrolysis, there are many convincing ecological arguments in favor of using modern advanced ceramics. ■

Distribution Today – All from One Source

> Rudy Van Parijs, Vice President Technical Development

There are almost as many electronic components as grains of sand on a beach. Consequently, it is important to have a reliable distribution partner capable of providing optimum solutions for custom applications. In view of the multiplicity of products, expert advice is just as important as rapid availability of components. EBV Elektronik is the leading semiconductor specialist in EMEA. As well as component distribution, stockholding and logistics solutions, the name EBV especially embodies many years of close customer relations paired with optimum technical and commercial solutions. At present, a team of 230 technical sales engineers are concentrated on a limited number of 27 manufacturing partners. 110 highly trained application experts are available to provide customers with comprehensive technical and developmental know-how. EBV places great emphasis on responding closely to customers' needs: over 70% of the company's current workforce of almost 900 people is in customer-facing roles.

In the EMEA semiconductor distribution business, EBV is by far the largest supplier of optoelectronic components, with a market share of over 35% (DMASS). With 41 years experience in the electronics field, EBV's experts know their market in detail, enabling them to select precisely the right products for the various development projects. Because semiconductor components – and LEDs as well – are only ever available for a limited time in their respective forms, it is all the more important that the right product is selected. Comprehensive advice is essential in this because if components with short specified service lives are used, there are bound to be problems during the production phase in terms of availability, or additional costs will be incurred by the need to hold high stock levels. EBV's experts are familiar with the service life capabilities of all the various components, and can advise you in selecting the optimum solution for your needs.

Because every lighting task is different, and LEDs offer countless options in terms of design, those lighting solutions require a great deal of advice and support. LED lighting systems can be installed by any qualified electrician, but LED light manufacturers and architects, for example, require technical support from electronics specialists. It is not merely the electronic circuitry of LEDs which differs completely from conventional lighting technology; the mechanisms on the component supply market are also different.

EBV General Lighting Competence Team

The EBV General Lighting competence team concerns itself exclusively with the deployment of LED technology from leading manufacturers in lighting applications. All the specialists working in the team have extensive market and product knowledge in the field of LED lighting, and so are able to provide their customers from throughout the EMEA (Europe – Middle East – Africa) region with comprehensive, expert

advice. Alongside general advice regarding the selection and procurement of suitable components, the team also finds the right service provider to assist in carrying out the work, or when required does the whole job itself. In such cases the EBV experts can also call upon their network of external partners, who are available to provide customers with their own specialist advice and engineering support in matters of electronics design, thermal management and – if required – visual design.

"If you are looking to implement a lighting project with LEDs, the specialists from the EBV Elektronik General Lighting competence team are the right people to call. We will supply the LEDs and the necessary driver modules and devise the concept, ensuring that creative lighting ideas are turned into reality. In a practical consultant role, we provide the link to developers and component fitters, and coordinate the realization of our customer's complete solution." ■

EBV is a daughter company of the Avent Group. Avnet, Inc., a Fortune 500 company, is one of the largest distributors of electronic components, computer products and embedded technology, serving customers in more than 70 countries worldwide. Avnet accelerates its partners' success by connecting the world's leading technology suppliers with a broad base of more than 100,000 customers and by providing cost-effective, value-added services and solutions. For the fiscal year ending June 27, 2009, Avnet generated \$16.23 billion U.S. in revenue. As Mr. Georg Steinberger, VP Communications Avnet EM EMEA, mentioned to LED-professional; the LED Lighting business is an important, strategic market and is managed individually by Avnet's daughter companies in the EMEA region. EBV manages the distribution business with a vertical handling of the market which also means through intensive technical and delivery support of their customers.



Based on the LEDs and the power technology in the background, the tower is a live application example of what can be achieved with LED technology. It also shows EBV as the right lighting partner with the appropriate expertise and the ideal product range..

Cost-effective solutions in lighting!

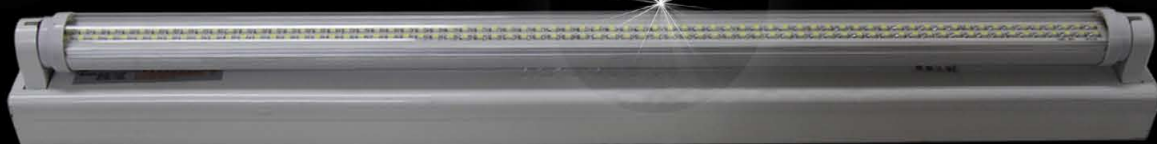

T10

Wave Shell

Clear Shell

Frosted Shell



Signcomplex has successfully got LED T10 tubes and downlight UL listed. The UL file numbers are E336039 and E336475.



LISTED
E336039

LED T10 Tube



LISTED
E336475

LED Downlight



SC-DL03



SC-DL06



SC-CL05



SC-CL06



SC-DLR-C3W



TRIDONIC

▼ enlightening your ideas

TridonicAtco becomes Tridonic.

„I’m looking forward
to the future in a new
light.“

Your light should be more than just good – it should be perfect. To achieve this claim, we provide you with support in all aspects of light and lighting. This support is based on our expertise in lighting applications combined with pioneering products, outstanding service and a huge passion for lighting. And we are underlining our commitment with a new name and a new appearance. This will put our position into sharper focus and make us unmistakable and easier to remember. Everything that made us excellent in the past has therefore been retained – and we can look forward to a future in which we continue to live up to our claim: We devote all our energy to your light. www.tridonic.com