

LpS 2011 - Review
AC LED Technology
Print-Optical Technology
Fluid Cooling

Light.



Reinvented.

The world's icons of technological advancement exist today as the result of great change and evolution. Now, it's the light bulb's turn. Introducing Samsung LED – developers of the energy-efficient, longer lasting light source of tomorrow. And at the core of LED lighting, you'll find the world's leader in semi-conductor and LED TV technology, who from LED chips to light engines & lamps, provides the complete solution for all lighting applications.

Samsung LED Lighting Solutions For more about Samsung LED lighting solutions, visit www.samsungLED.com



HV-DC



HV-AC



Ceramic



Light Engines



PAR, MR Lamps

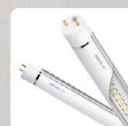

Tubes



A19 Lamps



SAMSUNG LED



Review of LpS 2011 in Bregenz

The first LED professional Symposium +Expo, the LpS 2011, took place from September 27th to 29th. Looking at this first event in terms of numbers with more than 700 registrants from 34 countries and a total of 54 booths it was a great success! On the other hand, the personal opinions of the attendees, visitors and exhibitors were even more important to us.

I would like to take this opportunity to say thank you to everyone for giving us your feedback and to all the people that contributed so much!

Here are some examples of the feedback we got. You can read more on our event website at: www.lps2011.com.

Dr. Gerhard Kuhn, head of the worldwide team for the BU Solid State Lighting form OSRAM Opto Semiconductors said: "High class presentations and good networking opportunities. It seems that the LpS in Bregenz will become an important meeting place for solid state lighting professionals."

Mr. Stefan Zudrell-Koch, Head of the Business-Development Team at Dialog Semiconductors wrote: "It was the exceptional quality of the entire LED professional Symposium that created an intensive spirit of innovation and creativity. At the LED professional Symposium, I received inspiration from the great people I met, from the high quality presentations and from the fabulous location and relaxed atmosphere. Many thanks to the LpS team for a fantastic time".

Thomas Zabel, CEO of e:lumix AG told us: "I attend many trade fairs all over the world but the LpS 2011 turned out to be the missing piece to the puzzle when it comes to trade fair landscapes. At the LpS 2011 we showed a bit of what is achievable and are very happy with how the event ran as well as its success. The LpS 2012 will surely be another highlight and most likely top the success of the LpS2011. e:lumix AG is also working on making this happen."

The success of the LpS2011 has given us even more motivation to start preparing for the LED professional Symposium on September 25 -27, 2012. Only three weeks after the first event more than 40% of the booths, which we increased from 54 to 82, have already been booked. The Call for Papers is open now and I would also like to take this opportunity to invite you to send us your abstract for your presentation at the LpS 2012. Submission requirements can be found online at: www.led-professional-symposium.com/call-for-papers

The LpS in Bregenz is the leading, annual, international LED lighting technology event staged in the heart of Europe. Innovations, trends and breakthroughs in LED lighting are presented in an exciting atmosphere. I'm looking forward to your contribution and to meeting you in Bregenz next year!

In addition to our technical articles and news from the world of LEDs this issue also has detailed information about the LpS 2011 put together for you by Mr. Arno Grabher-Meyer, Editor-in-Chief.

Yours Sincerely,

A handwritten signature in blue ink, appearing to read 'S. Luger', written over a horizontal line.

Siegfried Luger
Publisher

Don't forget: LpS 2012, 25-27 September, 2012
Call for Papers – www.led-professional-symposium.com/call-for-papers

Content

■	Editorial	p 1	COMMENTARY	p 4
	Imprint	p 60	News - PROJECTS	p 5
			News - PRODUCTS	p 6
			News - RESEARCH	p 22

■	EVENT	p 26
	LED professional Symposium +Expo 2011 Fascinated LED Lighting Specialists from All Over the World by Arno Grabher-Meyer, LED professional	

■	INTERVIEW	p 40
	New Aspects of AC LED Technologies Interview with Manuel Zarauza, Managing Dir., Seoul Semiconductor by Siegfried Luger, LED professional	

■	OPTICS	p 44
	LED Secondary Optics Technology by Molly Lin, Marketing Section Manager, Ledlink	
	Print-Optical Technology – Manufacture LED Lenses by Stacking Droplets-On-Demand by Richard de Vrie, CEO, Kurt Blessing, CTO, LUXeXcel Group B.V.	p 48

■	THERMAL	p 54
	Effective LED Replacement Bulb Cooling by Passive Convection by David Horn, CTO, Ronan Le Toquin, Tech. Director, Switch Lighting	

Advertising Index

Samsung	C2
Recom	p 3
Cree	p 7
Infineon	p 9
Curamik	p 9
Philips-Lumileds	p 11
Vossloh-Schwabe	p 13
LedLink	p 15
Lambda Research	p 17
Signcomplex	p 17
StellarNet	p 19
Instrument Systems	p 21
Fischer Elektronik	p 23
LED professional Symposium	p 25
Philips	p 29
Philips	p 31
Philips	p 33
Philips	p 35
Heraeus	p 39
Shat-R-Shield	p 41
Lighting Japan	p 42
Farnell	p 43
Kingbright Electronic Europe	p 46
Edison	p 47
Taiwan Int. Lighting Show	p 53
The ARC Show	p 59
LED professional Symposium	p 60
Tridonic	C3
Seoul Semiconductor	C4

LED Drivers

Buck/Boost LED Drivers - From 1W to 100W.

5 Year Warranty

Highest Efficiency

Dimming down to 0%

TRIAC Dimming

AC or DC Input



For Application Support contact your local RECOM sales contact or go to:
www.recom-electronic.com

RECOM



Dr. Nisa Khan

The President of LED Lighting Technologies, an engineering consulting company, has over 25 years of experience in the optoelectronics and lighting industries. She has a bachelor's degree in physics and mathematics, and holds master's and Ph.D. degrees in electrical engineering. Dr. Khan is best recognized for her pioneering work at AT&T/Lucent Bell Labs and Honeywell. Over the last 5 years, she has been engaged in independent R&D and delivered various engineering solutions for LED lighting systems. She has also written columns for Signs of the Times magazine.

CURRENT AND FUTURE LED LIGHTING MARKET TRENDS

The versatility of LED technology depends on understanding and solving its inherent challenges like electrical requirements, omni-directionality, chip yield, material scarcity, and thermal or lifespan complexities, which are familiar topics in the SSL industry now. Its current engagement in such issues should accelerate the manufacturing field to resolve challenges. The resulting advancements will escalate LED lighting markets substantially over the next several years. But what can we expect beyond the next five years?

Recently, in 2007's US Lightfair exhibit, many of the lighting companies lacking in LED technology R&D programs didn't see LEDs as next generation lighting solutions. This year, the same companies confidently displayed linear, tubular and compact LED-lamp prototypes and touted novel, new lamp configurations that illuminate living spaces. Their marketing descriptions claim the technology offers greater advantages over incandescent and fluorescent lights.

On the other hand, the measurement results from the DOE's recent, Round 11 CALiPER program tell a different story. The reports (Feb. and April 2011) on lamp samples from August 2010 establish that fluorescent and incandescent lamps still outperform LED counterparts, on average. Further, although LED lamps have higher efficacies, they still underperform in light output and other metrics.

LED lamp manufacturers who believe their T8 replacements may outperform the DOE samples should recognize that LED counterparts may look brighter when viewed directly. However, source brightness doesn't necessarily translate to higher ambient light output. Also, higher efficacy measures don't always translate to higher overall lamp efficiencies. Efficiencies must be compared when both lamp types' light output is equivalent. Still, their light distributions

may be different. Particular applications might require a particular type of distribution.

Due to today's development speeds, products better than those tested in Round 11 are available. Despite DOE's findings one shouldn't assume today's LEDs' capabilities are not as good as tubular fluorescent and compact fluorescent lamps. Market-available LED lamps still use the fixtures and electrical-input configurations of current lamps, which prohibit LED engineers from utilizing components that provide the most desirable lighting functions with the highest efficiency at the lowest possible cost.

LED market trends may change in five years due to increasing demand in such sectors as outdoor lighting and general purpose residential and commercial lighting. This will surely increase the overall LED market into 10's of billions of Euros. Although street lights, signs, and screen backlights all benefit from LEDs' directional, flat, and discrete scaling features, general-purpose lighting demands additional performances that LEDs are challenged to produce – like broader, more uniform light distribution and color quality. The SSL industry race will soon have to turn toward more sophisticated technologies to solve these challenges – but simultaneously need to churn low cost solutions.

Progress of that kind is surely boosted in a symposium like LpS 2011 that was held September 27-29, 2011 in Bregenz, Austria – in the "geographical" heart of Europe on the shores of Lake Constance. Still in its early stages, LED lighting will use far more sophisticated technologies in the future. They will become more reliable and affordable like common electronic gadgets. Supply chain manufacturers and researchers from the Central European region now have an effective and enjoyable venue to associate with their counterparts from around the world every year. At LpS, they can share ideas, solve problems, and seek partnerships to make collaborations more coherent, efficient and expedient!

N.K.

Philips Sheds New Light on Night Watch at the Rijksmuseum

Philips announced that since October 26, one of the world's most renowned paintings was bathed in a new light. Philips, founder of the renovated Amsterdam Rijksmuseum, presents Rembrandt van Rijn's Night Watch in innovative LED light, bringing out the best of the painting's color palette while offering increased sustainability and energy efficiency. Through the project, the two Masters of Light are reinforcing their intensive collaboration aimed at joint innovation in the area of LED lighting, setting the new standard for museum lighting.



The Rijksmuseum moved into the current building in Amsterdam in 1885 and is currently undergoing the biggest reconstruction and restoration in its history



Frans van Houten, CEO of Philips and Wim Pijbes, General Director of the Rijksmuseum in front of the masterpiece



The new LED lights protect environment and art while presenting the artwork in unprecedented beauty

The 5-year extension of the partnership was sealed this afternoon in the Rijksmuseum by Frans van Houten, CEO of Philips, and Wim Pijbes, General Director of the Rijksmuseum. The Night Watch was relit for the occasion by Philips, combining innovative LED lighting with an advanced light control system. The new lighting will help reduce the Rijksmuseum's energy consumption.

Frans van Houten, CEO of Philips said: "I'm proud that we had the privilege to work closely with the Rijksmuseum in creating a state-of-the-art lighting solution for an age-old and world-famous masterpiece. I look forward to continuing our partnership with the Rijksmuseum, which shares a history and global reputation equal to Philips and – like us – gives high priority to innovation."

Wim Pijbes, General Director of the Rijksmuseum, said: "For me as director of the Netherlands' leading museum, Philips is the ideal partner to shed new light on our Golden Age."

LED technology has been developed to the point that the Rijksmuseum felt it needed to adopt this innovation. The new lamps ensure optimal color rendering, lending an even greater expressive quality to the objects. In terms of light quality, the LED solution easily outstrips the halogen spot, praised for its warm color and broad spectrum.

A key element in the partnership between Philips and the Rijksmuseum lies in the intensive exchange of knowledge between the two parties with regard to the development of LED solutions for lighting art and architecture.

Philips has been involved since 2001 in the biggest restoration and renovation project in the 126-year history of the Rijksmuseum. During the renovation, the highlights of the Golden Age have been on display in the Philips Wing, attracting an average of 950,000 visitors a year since it opened in 2003. Starting in 2014, major exhibitions will be held in the wing, which will be permanently named the Philips Wing. From 2013 onward, the Rijksmuseum expects to welcome about 2 million visitors each year. ■

The World's First Array LED for Lighting Providing Luminous Flux of 17,675 lm

Citizen Electronics Co., Ltd. has developed five packages (shapes) and eleven types of LEDs, such as the world's first LEDs for lighting that produce high luminous flux of 17,675 lm. Features include one LED providing a wide range of luminous flux and it being possible to select an LED based on luminous efficacy. The LEDs can replace a variety of light sources.

A product demonstration was held during the "Hong Kong International Lighting Fair on October 27, 2011.

High luminous flux of 17,675 lm (5,000 K, Ra65 type) is achieved and luminous flux per LED is dramatically increased from 4,390 lm, which was the highest luminous flux of our conventional models.

Now it is possible to select from LED ranges based on luminous flux and luminous efficacy per LED. One LED can provide a wide range of luminous flux due to high heat dissipation by utilizing our original Chip on Aluminum technique and high efficiency of light extraction by reselecting and optimizing materials. The five packages and eleven types incorporate LEDs which can produce a wide range of luminous flux, and provide luminous flux over the entire range of approximately 100 lm to 17,675 lm (0.8 W-184 W classes). ■

New Cree MT-G: Unmatched Brightness, Color Quality & Consistency

Pushing LED brightness, color quality and consistency to new levels, Cree, Inc., a market leader in LED lighting, announces another step in eradicating today's energy-wasting halogen light sources. New XLamp® MT-G LEDs deliver higher brightness levels, unparalleled color quality and proven lighting-class reliability.

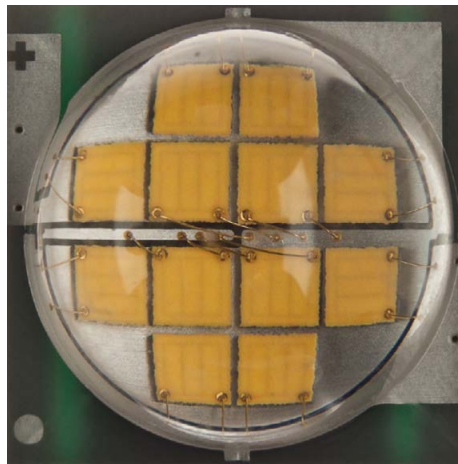

Cree's improved XLamp MT-G LEDs enable customers to address high-output halogen retrofits

The new MT-G LED is now more than 10% brighter, and can deliver up to 1670 lumens at 85°C in warm white (3000 K) color temperatures. Additionally, MT-G LEDs are now available in high CRI versions optimized for

applications such as retail and restaurant lighting where high CRI and lighting uniformity are required. These new capabilities can enable customers to extend existing MT-G designs, and enable new applications traditionally supported by halogen light sources.

USAI Lighting is one of the first lighting manufacturers to incorporate the new MT-G high-CRI LED into a luminaire—its award-winning NanoLED® lighting solution. The Cree MT-G-based NanoLED provides designers with color quality, efficiency, flexibility and control via proprietary optics to bridge striking aesthetics with functional application in a variety of interior installations.

"We have a relentless focus on providing only the best—and superior color quality is an essential part to ensuring our customers a high-performing lighting solution," said Bonnie Littman, president of USAI Lighting. "Being able to offer our customers halogen-like color and brightness along with the energy-efficient benefits of LEDs is going to be a game-changer."

XLamp MT-G LEDs are now available with brighter flux and with 90-minimum CRI options. Cree also offers more than 6,000 hours of IESNA LM-80 published lifetime data, which can assist lighting manufacturers with ENERGY STAR® qualification. With color temperature options ranging from 2700K to 5000K, all MT-G LEDs are available in 2- and 4-step EasyWhite™ color temperatures, with the option of either 6 V or 36 V forward voltages. ■

Series	CLL010	CLL020	CLL030	CLL040	CLL050	
Type	CLL010-0305A1	CLL020-1202A1 CLL020-1203A1 CLL020-1204A1	CLL030-1205A1 CLL030-1206A1 CLL030-1208A1 CLL030-1212A1	CLL040-1218A1 CLL040-1818A1	CLL050-1825A1	
Shape						
Size (mm)	9.5×9.5×1.4	13.5×13.5×1.4	19.0×19.0×1.4	28.0×28.0×1.4	38.0×38.0×1.4	
Color lineup	●High color rendering type: 2,700K, 3,000K, 3,500K, 4,000K, 5,000K (MacAdam 3-Step)		●High efficacy type: 5,000K			
Drive (W)	0.8~6.1	1.3~19.6	3.3~58.9	11.8~132.4	24.6~183.9	
Total luminous flux (lm)	95~590	165~1,970	415~5,780	1,480~12,915	2,885~17,675	
Applications	MR-16 Bulb 	A19 Bulb 	Bulb PAR30 	Downlight 	Floodlight 	Outdoor Lighting

Citizen extends CLL series array LEDs capabilities with high flux types with up to 17,675 lm

20% More Light and Improved Thermal Stability in Red, Orange and Yellow

The latest Oslon SSL LEDs from OSRAM Opto Semiconductors provide up to 20 percent more light output than their predecessors and offer improved thermal stability, particularly in Hyperred (660 nm). Energy-efficient applications such as commercial horticulture are therefore much more efficient. Behind this boost in performance lie the latest developments in Indium-Gallium-Aluminum-Phosphide chip technology (InGaAlP).

CREE XLAMP® LIGHTING-CLASS LEDs



XLAMP XM-L LEDs

OPTIMIZED FOR HIGH LUMEN APPLICATIONS

Industry's highest performance lighting-class LED— delivers up to 1000 lumens at 10W, 3A

Lowers system cost with breakthrough output and high efficacy



XLAMP XM-L EASYWHITE® LEDs

OPTIMIZED FOR 20-25W HALOGEN REPLACEMENTS

High lumen output in a small form factor

Industry's tightest color consistency



XLAMP MT-G EASYWHITE® LEDs

OPTIMIZED FOR HIGH-OUTPUT, SMALL-FORM-FACTOR, DIRECTIONAL-LIGHTING APPLICATIONS

High lumen output—up to 1550 lumens at 25 W, 85°C

Available in 6V and 36V options

CREE XLAMP LEDs ARE APPLICATION OPTIMIZED FOR LOWEST SYSTEM COST

REVOLUTIONARY!

Cree XLamp® Lighting-Class LEDs are purposefully designed to deliver the industry's best performance and optimized specifically for distinct applications. This makes it easy to design in the brightest, most efficient LED.

Our product portfolio enables revolutionary designs for either brighter, more efficient luminaires with fewer LEDs or space saving fixtures using less LEDs.

So whether you're designing exterior wide area lighting or a tightly focused indoor directional, you can have excellent performance and lower your system cost.

Get samples of Cree XLamp LEDs or contact a Cree Solutions Provider at cree.com or call us at +800.533.2583

Get Cree reference designs at cree.com/ref



CREE

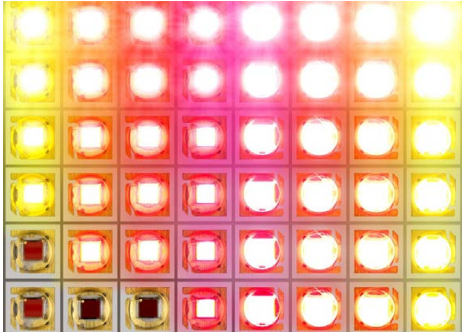

Osram increases output from colored Oslon SSL LEDs. Up to 49% of the current is converted into light

The latest chip developments make the new generation of Oslon SSL LEDs even more attractive as light sources that precisely meet these requirements. They offer high efficiency and good thermal stability, combined with a low thermal resistance of 7 K/W.

Depending on the wavelength (590 - 660 nm) the new LEDs achieve per increases of 10 to 20%. The flagship is the Hyperred version (660 nm) that hits this 20 percent mark. With a brightness of 400 mW at an operating current of 400 mA the LED is much brighter than the predecessor model. It converts 46 percent of the current into light. At an operating current of 350 mA it achieves an impressive 355 mW, which corresponds to a conversion rate of 49 percent. What's more, the LED has a long life: At an operating current of 700 mA and at a temperature of 80°C it will last more than 100,000 hours (L70/B50).

Fewer LEDs needed for the same output: In practical applications this means that fewer LEDs are needed to achieve a particular brightness level, or the same number of LEDs can be used to produce a higher brightness level. Martin Wittmann, Marketing Manager at OSRAM Opto Semiconductors explains: "Our customers benefit from the large increase in brightness because it leads to much shorter payback times. In commercial horticulture, for example, lighting systems with these LEDs can result in huge energy savings and low electricity costs."

With their compact package size of just 3 mm x 3 mm and choice of beam angles (80° and 150°), the Oslon SSL LEDs are particularly good for clustering so high brightness can be achieved on a small footprint. When combined with LEDs in the deep blue color (450 nm), they create a light color that is tailor-made for the requirements of commercial horticulture. ■

Bridgelux Micro SM4 LED for 20-40W Replacement Lamps

Bridgelux Inc., a leading developer and manufacturer of LED lighting technologies and solutions, announced an expansion of its broad portfolio of solid-state light sources to address the requirements of the \$1 billion 20-40W lamp replacement market with the introduction of the Bridgelux Micro SM4. Leveraging Bridgelux's award-winning array technology into a surface mountable LED component, the Micro SM4 delivers high flux density in a smaller footprint, making it ideal for applications where discrete LEDs are preferred.

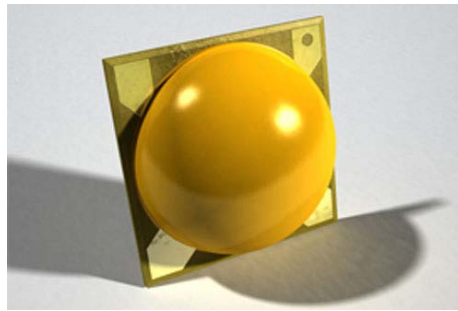

Bridgelux's most recent product, the Micro SM4 LED, addresses the 20-40W replacement lamp market and offers high efficiency or high CRI versions

Main specifications:

CCT	CRI (min)	Typical Flux Tj=25°C (lm)
2700	80	370
	90	330
3000	80	400
	90	360
5600	70	520

The Bridgelux Micro SM4 dramatically reduces the component count, cost, complexity and size of the lighting system, enabling a cost-effective, high performance LED solution for diffuse and directional lighting, such as 20-40 watt incandescent, 20-35 watt halogen, B10-style (candelabra), and low wattage compact fluorescent lamp replacements.

Using only 4.6 watts of power, the Bridgelux Micro SM4 will deliver between 330 and 520 lumens in both warm white (2700K and 3000K) and cool white (5600K) color temperatures. Minimum 80 and 90 CRI options, with 3-step MacAdams Elipse color

selections, will be offered for warm white products. Production shipments of the Micro SM4 will be available in the first quarter of 2012.

"The Bridgelux Micro SM4 delivers comparable efficacy and performance to some of our smaller form factor arrays in the size of a miniaturized discrete component," said Jason Posselt, vice president of marketing at Bridgelux. "The ability to use high volume surface mount assembly methods will open up new design integration options and help our customers to improve both cost-to-market and time-to-market."

The new Micro SM4 features the latest technical advancements in epitaxial GaN layer growth, LED chip design and packaging technologies. These products are configured to align with industry standard drive currents to simplify the electronic driver selection process for new lamp and luminaire product development, and are offered in both 6V and 12V design configurations to enable driver design flexibility. As with all Bridgelux light sources, the Micro SM4 is offered with a five year warranty. ■

Seoul Semiconductor Launching New Acrich 2

Seoul Semiconductor announced the launch of its 'Acrich 2,' providing long life time, low energy consumption and design convenience. The Acrich 2, introduced in 4 W, 8 W, 12 W and 16W boards, will provide a replacement LED solution to replace not only 40 W, 60 W and 100 W incandescent bulbs, but also MR16 halogen lamps and down lights.

The newly introduced 'Acrich 2' provides more than a 90% increase in power efficiency by improving the power factor by up to 97% as compared to Seoul Semiconductor's predecessor 'Acriche' version, and the THD is lower than 25% to comply with the requirements of different countries, including DOE and others. Through cutting edge IC technology, lighting manufacturers can directly plug Acrich 2-based products into the wall without consideration of electrical conditions.



Acrich 2 - 4W, 8W and 12W modules

Conventional LED bulbs use electrolytic condensers resulting in temperatures of over 70°C. These temperatures shorten product lifetime to less than 10,000 hours. Other well-known brand products have power factors in the range of 0.5, resulting in two times less efficiency for the same 100lm/W efficiency at the LED level.

John Bae, Vice President of Seoul Semiconductor, states that “high cost, low efficiency and short lifetime which have been critical problems for conventional LED bulbs, can now be resolved through the Acrich 2.” ■

Xicato: New Artist Module with Increased Efficacy

The XSM Artist Series, incorporating Xicato’s patented Corrected Cold Phosphor Technology™, has expanded to include a new 1000 lumen module. The new addition to the popular Artist Series maintains Xicato’s “light quality without compromise” performance, with color quality on par with halogen and color point consistency within 1 x 2 MacAdam ellipses initial, and over time.



New ILD Product Family – Driving High Power LEDs



Infineon Technologies expands its portfolio of switch-mode LED drivers for high power LEDs.

- Wide input range from 4.5V to 40V
- Scalability in output current from 350mA up to multiple amperes
- Alternative dimming concepts: digital or analog
- Basic protection features contributing to longer LED lifetime

To learn more about our LED drivers for general lighting, please visit

www.infineon.com/lowcostleddrivers

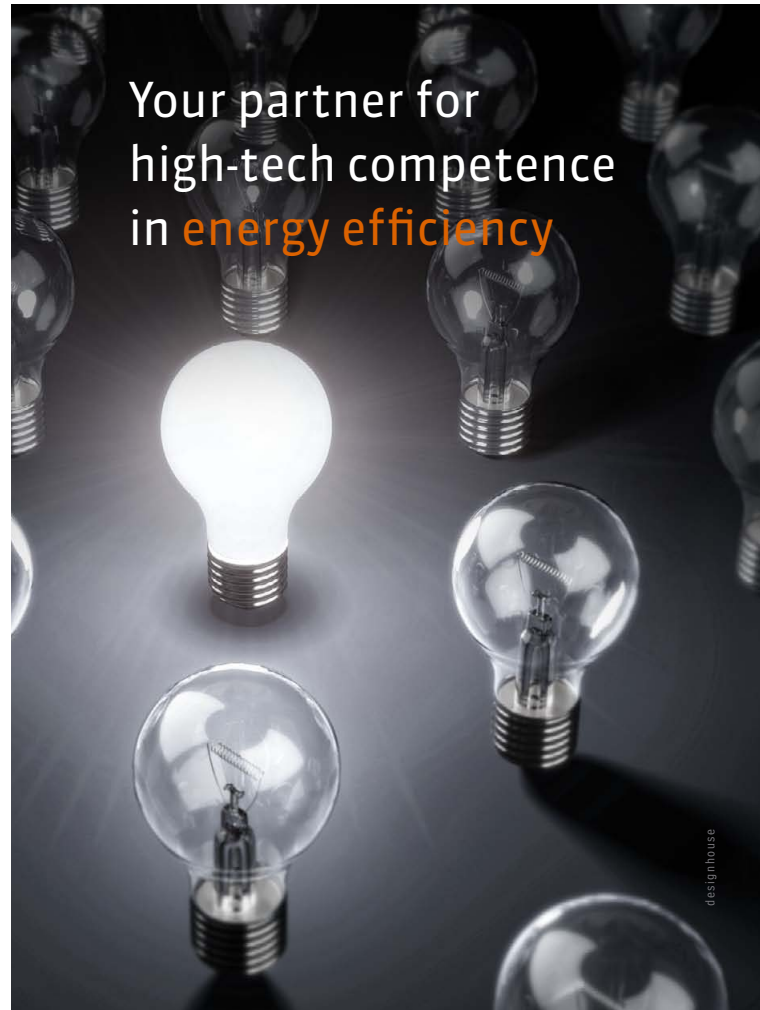

Your partner for high-tech competence in energy efficiency

High thermal conductivity
Excellent for chip on board
Optimized heat spreading
DBC SUBSTRATE

Highly integrated cooler
Outstanding thermal performance
Customized design
DBC COOLER

curamik electronics GmbH
Am Stadtwald 2
D-92676 Eschenbach
Phone +49 9645 92 22 0
info@curamik.com
www.curamik.com

A division of
ROGERS
CORPORATION



Ra = 97 typical, 95 min. Data for 3000K, 2700K and 4000K are similar

	Ra	R1	R2	R3	R4	R5	R6	R7	R8	R9	R10	R11	R12	R13	R14	R15
Standard XSM	81	80	85	89	81	78	80	86	66	16	64	79	58	81	93	75
Artist Series XSM	98	98	99	98	98	98	97	98	98	96	99	98	88	98	98	98
Typical IR coated Halogen Dichroic	98	98	99	99	99	98	98	99	97	92	97	98	97	98	99	97
Typical Compact Metal Halide	82	90	94	69	82	81	81	87	71	27	59	62	55	93	78	88
Typical Compact Fluorescent	87	91	93	86	91	89	90	88	70	17	76	91	81	93	92	81

Independent measurements by University College, London

Xicato's modules are the first choice for high quality lighting in numerous applications like the Lucifer Lighting Company's executive office or Harrods wine tasting suite

The Artist Series is ideal for applications where quality of light is paramount including galleries, museums, retail and residential. At 1000 lumens, lighting professionals now have a solution for higher ceiling heights or to create stronger accents.

The XSM Artist 1000 is rated at 22.1 W (700 mA), yielding an efficacy of 45 lumens/watt. The XSM95XX-1000-B family of products is available in 2700 K, 3000 K, and 4000 K.

As the series has expanded to 1000 lm, so have efficacies. Xicato's Artist Series 700 lm module efficacy has increased 45% to 48 lm/w.

Through Xicato's unique patented "future-proof" design, the new 700 lumen Artist Series module is optically, mechanically and thermally backward compatible with the previous version. This means for end-users if replacements do have to be made due to a change in desired CCT, a fully compatible, light-technically identical replacement will always be available. No other module technology can make a similar claim.

Typically the CRI is only evaluated for the first 8 pastel colored reference samples of the CRI system. The Artist Series has also been optimized to get excellent results for the more saturated (see R9) and skin color (see R15) samples of the CRI reference set. This performance not only outperforms other LED solutions but also traditional lamp types like compact fluorescent and compact metal halide. ■

Philips Fortimo LED Disk Modules - for MR16 Halogen Replacement

Philips introduces the Fortimo LED Disk module 300 lm, following the earlier introduced 800 lm version. The Fortimo LED Disk modules are easy to design in, thanks to the integrated driver and built-in beam angle, and they combine a long lifetime with excellent warm light quality at a very affordable cost.



With a diameter of 52mm and a 36 degree beam angle, the 300lm LED disk is an attractive LED module alternative for the MR16 & GU10 lamps

The Fortimo LED Disk modules are ideal for use in ceiling-mounted or small spotlight luminaires in applications areas such as bars, restaurants, hotels, wellness facilities or even cruise ships requiring high-quality light and a cozy ambiance.

"The compact form factor of the module with integrated driver and optics is highly valued by luminaire manufacturers. This allows them to simply replace existing light sources such as

halogen or incandescent in hospitality environments and in home luminaires without going through intensive redesigning efforts of their existing luminaires", according to Marius Schlatmann, Marketing Manager for Philips OEM Lighting Solutions for Home & Hospitality. ■

Future Lighting Solutions Demonstrates Remote Phosphor Downlight Solution

Future Lighting Solutions has unveiled its newest lighting innovation, the Remote Phosphor Downlight Solution at the Hong Kong International Lighting Fair 2011.

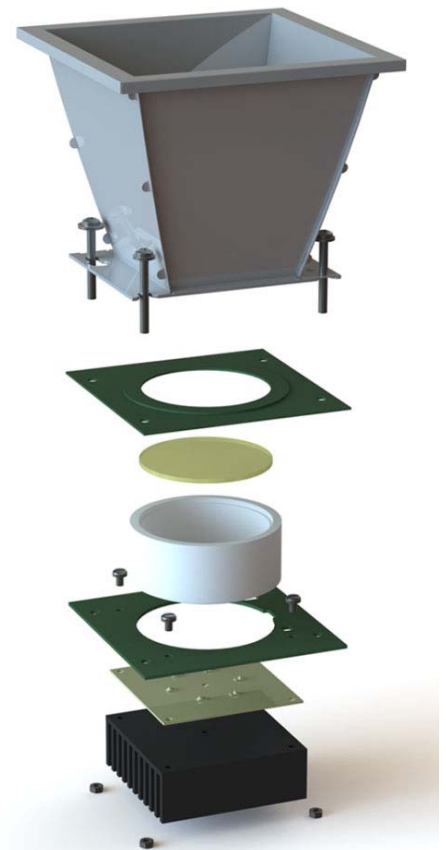

All components to build the core of a remote phosphor based luminaire system is available from Future Lighting Solutions

Visitors to the Future Lighting Solutions booth, located at 1D-D32 in the Hall of Aurora, learned about the latest LED technologies and how they can help decrease time to market. Featured will be an innovative Remote Phosphor Downlight Solution, comprised of



Transforming Light

LUXEON LEDs are changing the way we light the spaces we live, shop and play in. With unparalleled efficiency, quality, and reliability, LUXEON LEDs are a simple way to transform lighting and improve the well being of our environment.

Whether you're lighting a restaurant, roadway or architectural masterpiece, you can count on LUXEON to deliver long life, high-quality white light while reducing energy consumption.

To learn how LUXEON can help you transform lighting, call our partner, Future Lighting Solutions, at +1-888-589-3662, or visit www.philipslumileds.com/transform

LUXEON[®]

PHILIPS
LUMILEDS

LUXEON® Royal Blue LEDs, a Cubilux mixing chamber from CerFlex International, a ChromaLit™ Remote Phosphor Light Source Element, and also includes a reflector and a heat sink. This remote phosphor solution offers cost savings, improved efficacy up to 30%, and a drastic reduction in glare. It also allows for the flexibility to change CCT and CRI by exchanging the remote phosphor element.

“This design approach enables customers to have a highly customizable option at their fingertips from readily available components, allowing for a drastic reduction in design time, and a quicker time to revenue,” explained Patrick Durand, Worldwide Technical Director for Future Lighting Solutions. ■

Ledzworld: First Truly Compatible MR16 LED Lamps & Solid State Cooled Par16 LED Lamp

Ledzworld Technology, an innovative R&D and manufacturing company of high-end LED retrofit lamps, unveiled its Chameleon Driver Technology during the International Lighting Fair in Hong Kong and launches the world's first LED lamp with a ground breaking Solid State Cooling System™ (SSCS).



Ledzworld introduced unique MR16 lamps, using Chameleon Driver Technology and solid state cooling technology

Chameleon Driver Technology Enables the First Truly Compatible MR16 LED Lamp: The biggest challenge for manufacturers of retrofit LED lamps is the compatibility with thousands of existing combinations of dimmers and transformers.

The Chameleon driver of Ledzworld is a technological break-through. Its arrival will change the industry standard. The driver adjusts itself to its environment. It first detects

the transformer type, analyses its wave-form and then adjusts itself to make a perfect electrical fit with that particular transformer.

Chameleon drivers make Ledzworld retrofit lamps truly “plug and play” devices that can be used in most of the possible combinations of the commonly used drivers and dimmers. These drivers will create lamps that are hassle free and true halogen replacements.

Solid State Cooled PAR16 LED Retrofit Lamp:

Thanks to built-in solid state cooling technology, this 14W lamp is able to dissipate double the heat that a standard sized Par16 can usually handle. During the Hong Kong Lighting Fair (27-30 Oct 2011) Ledzworld will demonstrate the technology in its Par16 featuring a whopping output of 800 Lumen (3000 CCT) and a system efficacy of >70 Lumen per Watt.

The operating temperature of this lamp is much lower than Ledzworld's 8W Par16 despite the absence of an aluminium heatsink. This enables Ledzworld to manufacture reliable LED retrofit lamps with an ultra-high lumen output. In Q1 2012 Ledzworld will announce its 2600 Lumen Par38 lamps making use of the same Solid State Cooling technology.

Says Ken Chakravarti, CTO of Ledzworld; There are no moving parts inside so these lamps are not cooled by an active fan. The Solid State Cooling System™ (SSCS) is an elegant solution that actively removes as much as 30 watts of heat from LED lamps. The Solid State Cooling technology eliminates the need for bulky heat sinks, noisy fans and the need for exotic materials or new fixtures and outlets enabling Ledzworld to build LED retrofit lamps that fit in the existing residential and commercial lighting infrastructure and can be mounted in any direction. With the Solid State Cooling System integrated into our lamps, a system level reliability of greater than 25,000 hours of operation is achieved.

Our new technology enables us to build extremely reliable products and to optimize the utilization of the light-sources. The lamps become more efficient and it allows us to look beyond existing production processes as we do no longer need cast aluminium heat sinks. As a matter of fact we do no longer need a heat-sink at all. ■

New E27 Bulb from Optogan: Launch of Design Lamp Made in Europe

The Optogan Group releases its first original domestic LED lamp on the Russian market. The E27 bulb was designed in cooperation with the design studio art.lebedev to replace the 60W incandescent bulb.



Made of state-of-the-art technology, consisting of German-Russian components, the E27 lamp has features on par with the best of world standards

The new light source is significantly less expensive than its European counterparts. From September onwards, the first contingent of bulbs will be available for 995 Rubles in both Moscow and St. Petersburg. Early 2012 the bulb will be introduced to the global market – the target price then should be around 30 Euros.

Made of state-of-the-art technology, consisting of German-Russian components, the E27 lamp has features on par with the best of world standards.

Optogan's designer bulb is a convincing contribution to global energy savings. The lamp's power consumption tolls 11 W, which is about 6 times lower than of an incandescent lamp. The life cycle exceeds 50,000 hours - this corresponds to 6 years of continuous illumination. Should the bulb be used 3 to 4 hours per day, the Optogan E27 is designed to operate for more than 46 years.

One other point: Optogan's E27 has solved the problem of light fluctuations - fluctuations which adversely affects human health when working long-term under artificial lighting. E27 provides a smooth, warm white light which has a positive effect on a person's well-being. Unlike incandescent and fluorescent lamps, it does not contain dangerous substances such as mercury or lead. ■

Osram's Next LED Lamps: Omni-Directional - 340°, 30 Years Service Life, Over 1000 lumen

With its Parathom Pro Classic A75 Advanced, OSRAM is launching the first LED lamp capable of replacing a 75-watt incandescent lamp. Boasting a consumption of just 14 watts, the LED lamp uses over 80 percent less energy than its incandescent equivalent and has a service life of up to 30,000 hours. In other words, this lamp won't need changing for about 30 years. It will be available to consumers in specialist stores from early 2012.

The new Parathom Pro Classic A75 Advanced is the attractive LED substitute for the ordinary 75-watt incandescent lamp. With a light output of 1055 lumens and a power consumption of just 14 watts, it easily saves more than 80 percent energy in comparison to a 75-watt incandescent lamp at the same time. The light from the Classic A75 Advanced resembles that of an ordinary incandescent lamp. And as additional bonus, the new LED lamp is infinitely dimmable.

Design for Greater Efficiency:

The innovative design of the Parathom Pro Classic A75 is its most unusual feature, permitting an extremely high light radiation angle of 340°. The LEDs are arranged on surfaces all around the lamp and hence no longer radiate their light in just one direction, but offer all-round illumination. The lamps will be available in specialist stores from the start of 2012 for a recommended retail price of around 50 euros. Thanks to the electricity saved, the acquisition costs pay for themselves after just 3 years. ■



Osram Parathom Pro Classic A75 Advanced in the new design, the LEDs are arranged all around the lamp and radiate in all directions

	75-watt incandescent lamp	Parathom Pro Classic A75 Advanced
Watts	75 W	14 W
Lumens	935 lm	1055 lm
Acquisition costs	~ 1 euro	~ 50 euros
Mean service life	1 year*	30 years*
Energy savings	0%	~ 80%
Cost savings over 30 years**	0 euros	~ 365 euros

* Given an average service life of up to 1,000 hours (incandescent lamp) or 30,000 hours (LED lamp) and daily operation of approx. 2.7 hours.

** Given an average electricity price of 0.21 euros per kilowatt hour.



Linear LED Modules: The Perfect T5/T8 Replacement

Vossloh-Schwabe's new built-in LED system for T5/T8 replacement.

LED technology delivers many advantages:

- long service lifetime 40,000 h (L90)
- very compact size
- highly efficient: 98 lm/W at $t_j = 85^\circ\text{C}$
- very low thermal resistance: ceramic PCB
- COB technology (chip-on-board):
 - no single light dots, one homogeneous light bar
 - optimum for use with reflectors



Vossloh-Schwabe Deutschland GmbH

Phone +49/23 51/10 10 · www.vossloh-schwabe.com

Intematix Phosphor Blend Accomplishes Near Perfect Light Quality for LEDs

Intematix Corporation, a leading innovator of patented phosphor materials and components for high-quality LED lighting, announced that it has demonstrated a phosphor blend that provides a near perfect color rendering index (CRI) of 98 and R9 value of 99 when applied to a reference LED package.



With its new phosphor blend, Intematix improves the critical R9 value to 99 and achieves an overall CRI of 98

The results highlight Intematix's unique phosphor leadership in the LED lighting industry, as the phosphor blend combines three separate material families, all offered by Intematix. This achievement paves the way for designers to develop LED lighting systems for retail, hospitality, residential and museum locations that greatly enhance the appearance of apparel, environments, skin tones and artwork.

"Reaching 98 CRI is huge – it means that by adding Intematix phosphor, an LED package can render true color," said Dr. Yiqun Li, chief technology officer and executive vice president at Intematix. "That's the efficiency of Silicon Valley with the light quality demanded by the finest New York City gallery, Milan boutique or Hong Kong hotel. This benchmark gives our customers the ability to create the highest quality lighting designs and fixtures."

The 98 CRI milestone was demonstrated in Intematix's laboratories using a blend of three of the company's patented phosphor product platforms. Intematix provides lighting manufacturers with competitive advantages in the development of innovative LED systems for display and general lighting applications, including high quality light and energy efficiency. ■

LEDs More Efficient Thanks to New PLEXIGLAS® Molding Compounds

LEDs are indispensable for modern lighting design. Two new PLEXIGLAS® molding compound grades now enable lighting manufacturers and designers to use energy-saving LEDs to even better advantage.

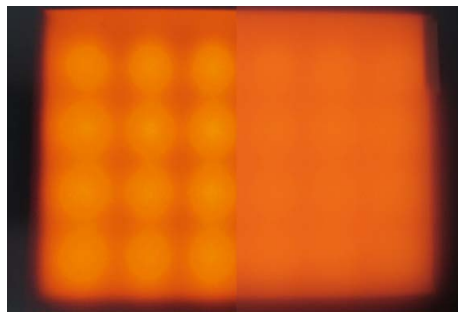

Evonik's new PLEXIGLAS® specialty colors for backlighting make hot spots a thing of the past (left: visible hotspots; right: no hotspots with PLEXIGLAS® LED)

PLEXIGLAS® LED molding compounds have been developed in two new specialty colors for extremely flat lighting installations with direct LED lighting. The light-diffusing molding compounds transmit over 60% of light and therefore prevent fluctuations in luminance, even at extremely low wall thicknesses. That offers entirely new creative scope to designers, who can now place LEDs very close to light covers, without visible hot spots.

Previously, products offering good light diffusion were also less transparent. Not so with the new product that has been specially developed for LED edge-lighting systems and appears crystal-clear when unlit. The extremely efficient formulation of the new PLEXIGLAS® molding compounds from the PLEXIGLAS® LED product family makes it possible to combine these two properties. The combination of transparency and the play of different colors allows designers to create specific moods, whether for ambient lighting of furniture and in vehicles, or for displays, control systems, circuit elements or industrial lighting.

The new PLEXIGLAS® LED molding compound is available in four grades that allow illumination of the entire component surface up to an area of 96 centimeters, with homogenous light output. The material is suitable for all thermoplastic processing methods. ■

LED Engin: Narrow Beam Lens and Emitter Combinations Cut Fixture Size

LED Engin, Inc., introduces two narrow-angle TIR high efficiency lenses for the LuxiGen LZC- and LZP- series emitters; the proprietary 8-degree narrow spot lens and 15-degree spot lens. This combination enables an array of high brightness LEDs to be replaced by a single LED emitter and lens, cutting fixture size by at least 50% and delivering superior beam control.



LED Engin's narrow 8 and 15 degree TIR spot lenses provide in-source color mixing and allow replacement of 35W metal halide lamps

The TIR lenses collimate the LED light into efficient, well-controlled beams that maximize the usable lumens in the target area. They provide the throw or distance required for many new lighting applications with a smooth beam of uniform intensity that minimizes glare and creates crisp, single shadows. The 8-degree narrow spot lens, coupled with the LZC 12-die, multi-color RGB, RGBA or RGBW emitters, provides effective in-source color mixing for dynamic color in entertainment and architectural lighting applications. When used with white LZC or LZP series emitters, the combination can replace 35 W metal halide lamps in downlighting and bay lighting applications with an efficient, cool-running unit that has a service life of 50,000 hours.

On-axis efficiencies are 12cd/lm for the 8-degree lens plus LZC emitter and 8cd/lm for the 15-degree lens and LZP emitter. Up to 36,800 cd center-beam candle power can be produced by a single lens/emitter combination.

The lenses, which are made from optical-grade polymethyl methacrylate (PMMA) and UL-rated, are now available with holders that mount easily to LED Engin's LuxiGen metal core printed circuit boards (MCPCBs). ■

Minimising the glare and optimising the efficiency of the LED luminaries at the same time is one of the barriers for LED lighting manufacturers.

Ledlink recently launched a series of “hybrid optics” which combines the secondary and the reflector in one part to maximise the output but minimise the glare, and moreover it looked similar to the traditional halogen lamp.



Hybrid Lens Series



CREE/MTG
LL01CR-ABGxxL
MR16 · PAR 20
FWHM25 · 40 · 60



Edison/Federal 5050
CREE/XML MTG
LL01ED-ABYxxL
MR16 · PAR20
FWHM25 · 40



Edison/Edipower II
LL01ED-ABXxxL
PAR30
FWHM25 · 40



Edison/Edipower II
LL01ED-ASAxL
PAR 38
FWHM25 · 40

Patented HV9861A: High Accuracy via Average Mode Control

Supertex, Inc. introduced HV9861A, an open loop, average current mode control, LED driver integrated circuit (IC) designed to drive LEDs using a buck topology. It is well suited for a variety of solid-state lighting applications, including TV and monitor backlighting, signage, decorative, and general lighting.

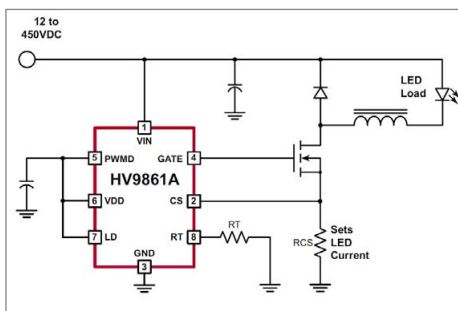

Typical simplified application circuit with Supertex's HV9861A LED driver

Features:

- Fast average current control
- Programmable constant off-time switching
- PWM / linear dimming input
- Output short circuit protection with skip mode
- Ambient operating temperature -40°C to +125°C
- Pin-compatible with the HV9910B and HV9961

Applications:

- DC/DC or AC/DC LED driver applications
- LED backlight driver for LCD displays
- General purpose constant current source
- LED signage and displays
- Architectural and decorative LED lighting
- LED street lighting

Because of the patented, novel scheme of current control it employs, HV9861A doesn't produce a peak-to-average error like many LED driver ICs, and therefore, it greatly improves the accuracy and line and load regulation of the LED current. The IC provides typical current accuracy of +/-3% and requires no loop compensation or high-side current sensing because of its proprietary control scheme. The internally regulated voltage (Vdd) for HV9861A is 7.5V. ■

IR: Cost Effective, Non-Isolated, High Performance, High-Voltage LEDrivr™ IC

International Rectifier has introduced the IRS2980 high-voltage buck regulator control IC for LED light bulb replacement, LED tube lighting and other non-isolated LED driver applications.



International Rectifier accelerates LED driver business introducing the IRS2980, the first member of the new LEDrivr™ IC series

Specifications:

Part Number	RS2980SPBF
Package	SO8
Voltage	600 V
V _{TH}	0.5V
I _o	+/- 80/260mA
Max Frequency	50kHz

A datasheet and application note are available on the International Rectifier website at www.irf.com. A reference design, the IRPLLED7, featuring the IRS2980DS is also available.

Rated at 600 V, the IRS2980 is the first in a family of high-voltage LEDrivr™ ICs, and utilizes hysteretic average current mode control for precise current regulation. The LED buck driver features low-side MOSFET drive with high-voltage internal regulator and high-side current sensing. The converter is compatible with electronic PWM dimming allowing for 0%-100% current control.

"In the rapidly growing solid state lighting sector, there is a need for low cost driver electronics to supply constant current output to high brightness, high power LEDs. The new IRS2980 offers improved performance at a lower system cost than alternative solutions for non-isolated LED driver applications," said Peter Green, LED Group Manager, IR's Energy Saving Products Business Unit.

Available in an SO-8 package, the IRS2980 utilizes IR's advanced high-voltage IC process which incorporates latest-generation high-voltage level-shifting and termination technology to deliver superior electrical over-stress protection and higher field reliability, in addition to other new features and enhancements. ■

Offline LED Driver Provides Smooth Dimming and Maximizes Efficiency

The MAX16841 is an LED driver for AC line (100 V, 120 V, 220 V, and 230 V AC) input lamps. It features proprietary control of the input current, which allows lamps to dim smoothly from full to zero light intensity, while providing active power factor correction.



Input current shaping of the MAX16841 satisfies the requirements of triac dimmers on start-up current and hold current to avoid flicker at low dimming values

Key Features:

- Smooth dimming with leading (Triac) and trailing-edge dimmers
- Active power factor correction
- Non-isolated (e.g., buck) and isolated (e.g. flyback) topologies
- Universal 90 V to 264 V AC input range
- Constant frequency-control scheme maximizes efficiency at high and low AC line voltage
- Constant power control, with no need for optical couplers
- Very-low quiescent current
- Output Open and Short Protection
- Thermal shutdown
- Available in an 8-Pin SO package

It is a very flexible product that can be used in isolated (e.g., flyback) and non-isolated (e.g., buck) configurations, providing in both cases accurate setting of the output current with no

Top 5 Reasons to Buy TracePro

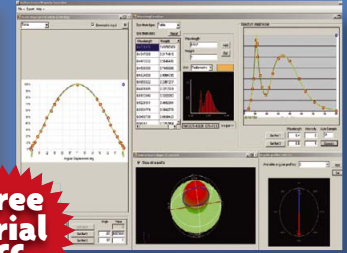
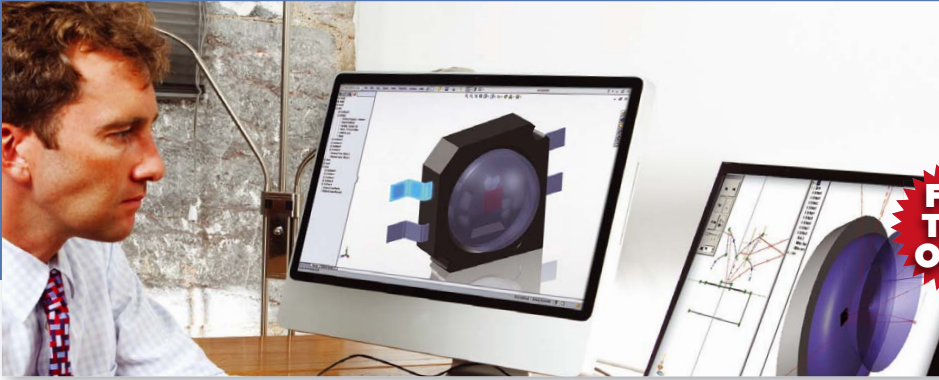

**Free
Trial
Offer**

For a 30 Day Trial Offer Visit
www.lambdares.com/trials

TracePro® Software - Design and Analyze Any Optical/Illumination System

1. Easiest-to-use opto-mechanical software with full CAD integration
2. Simple Interactive Optimizer: sketch geometry, set variables, digitize targets, optimize
3. Lowest entry price for a permanent license
4. Multiple editions to fit your needs, with an upgrade path as you need more capability
5. Define your optical properties directly in SolidWorks® by using our TracePro Bridge Add-in



TracePro is a registered trademark of Lambda Research Corporation and SolidWorks is a registered trademark of Dassault Systemes

Lambda Research Corporation, 25 Porter Road, Littleton MA 01460 (+1) 978-486-0766 www.lambdares.com



We bring innovation and give impression
Technology and Green

need for opto-couplers. The constant frequency-control technique of the device allows maximization of the conversion efficiency at both low and high AC line, by operating at the conduction mode that minimizes the total of conduction and switching losses. The device can be configured for universal input (90-264 V AC) dimmable applications, allowing the design of an LED lamp that operate and can be dimmed worldwide.

This product can be used without electrolytic capacitors, thus maximizing the lamp lifetime, and also features thermal shutdown, current limit, open-LED protection and VCC undervoltage lockout. It operates over the -40°C to 125°C temperature range and is available in an 8-pin SO package. ■

Fairchild's Smart LED Lamp Driver IC Solves Small-Space Dimming Challenges

As LED lighting continues to grow in popularity, especially in residential lighting applications, designers are looking for efficient dimming solutions – when compared to TRIAC methods – that also fit within existing sockets. Additionally, these solutions need to work reliably in a small space while providing high efficiency.

To help designers meet this challenge, Fairchild Semiconductor, a leading global supplier of high performance power and mobile products, developed the FL7701

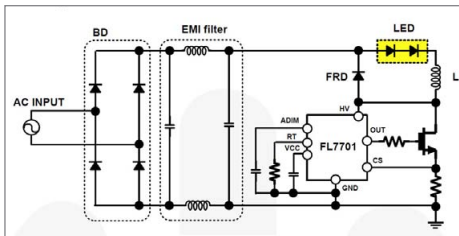

A typical application circuit using Fairchild's new FL7701 driver IC

Smart Non-isolated Buck LED Driver with power factor correction (PFC). The device uses a digital technique that allows it to automatically detect the AC input voltage condition, allowing it to create a special internal reference signal that results in high power factor correction. The FL7701 will also

work from a DC input voltage condition, automatically sensing AC versus DC input voltage conditions. The traditional technique of using a transformer in an MR application incurs additional losses with the transformer conversion; this traditional inefficient method can now be replaced using the FL7701 connected directly to a DC or AC off-line input.

The FL7701 combines high functional density in a small form factor that provides designers up to 20 percent lower bill of material (BOM) costs and up to 60 percent board space savings. This combination creates a solution suitable for the space-constrained PCB sizes found in LED lighting applications and supports analog dimming.

The high degree of integration designed into the FL7701 provides the high reliability required to increase the luminary lifespan to more than five years. Reliability is also improved since no electrolytic capacitors are required.

Digital power factor (PF) realization (>0.9) and lower total harmonic distortion (THD), along with the 90% electrical efficiency results in increased energy savings for the end system to meet the most stringent worldwide regulations, such as Energy Star®.

Available in an SOP-8 package, the FL7701 is ideal for interior decorating/ornamental lights; LED light bulbs or down lights in PAR, Reflector, MR or classic styles E26/E27 or Bi-Pin base, as well as LED lamps for low power lighting fixtures. ■

Linear LED Driver from Diodes Inc. Simplifies Low Power LED Control

Integrating a high gain NPN transistor with a 30 V rated pre-biased NPN output transistor, the AL5802 linear LED driver from Diodes Inc. provides a simple, cost effective and low EMI solution for controlling current in up to 9 low power series-connected LEDs. With an open collector output capable of operating between 0.8 V to 30 V, the SOT26 packaged driver will support 12 V and 24 V power supplies and deliver LED currents between 20 mA to 100 mA for LED signs, lamps and automotive interior display applications.

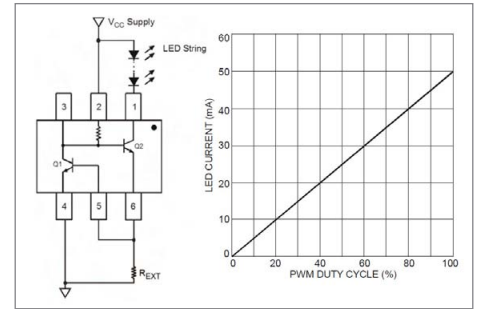

Diodes AL5802 is especially designed for off-line applications or LED signs

The LED current is set via an external low value resistor, the one additional component required by the driver. By generating a reference voltage of 0.65V across the resistor, the internal high gain transistor helps minimize power losses and ensures supply voltage headroom. The negative temperature coefficient of the reference voltage means that LED current is automatically reduced at high temperatures, thereby helping to protect LEDs and improve circuit reliability.

PWM dimming of the LED string is also simple to achieve by either driving the device bias pin with a low impedance voltage source or driving its enable pin with an external open collector NPN transistor or open drain N-Channel MOSFET. The AL5802's wide ambient temperature operating range of -40°C to +125°C enables it to be circuit mounted very close to the LEDs in space limited lighting applications. ■

Diltronics Introduces LUC04 - A Compact Driver for Integration into Lighting Fixtures

With the LUC04, the high-tech company diltronics based in Jena, Germany, offers a highly innovative driver module for controlling LEDs. The integration module has been specially designed to be fitted inside the lighting fixture. With the controlLED technology developed by diltronics it enables individual and energy-efficient control of up to four LED channels, and lamps with a total power of up to 280 W. The LUC04 allows light manufacturers to upgrade existing multi-LED lamps to DALI or DMX-dimmable luminary.

With this driver the innovative high-tech company is focussing on manufacturers of both indoor, and outdoor lighting systems. As

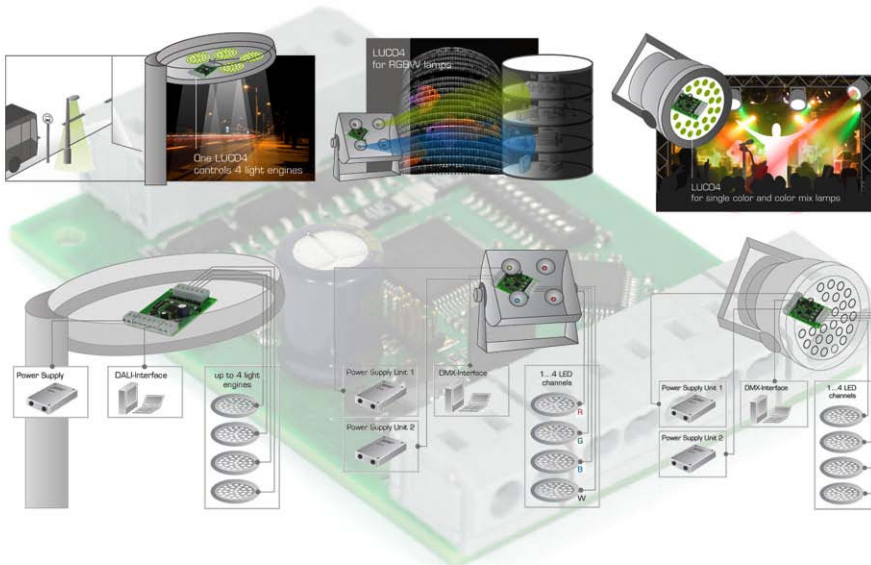

Diltronics' LUC04 4-channel driver allows easy implementation of DALI or DMX for various demanding lighting applications

Stephan Schulz, CEO of diltronics GmbH, explains: "Limited space in the luminary and the high level of heat generated by conventional LED drivers create problems for many lamp manufacturers with dimmable LED drivers. The LUC04 is compact, light and generates no waste heat, but can nonetheless dim up to 280 Watt LED power and provides four independent DALI/DMX devices. With this new product we are once again setting new standards in terms of energy efficiency and power density."

The driver has been specially developed for lighting concepts that have to be space-saving and at the same time provide high light intensities. Thanks to its compact design, it allows lightweight encapsulation and reduces the cabling effort in the body of the lighting fixture. About the technical characteristics Schulz said that: "Building up on our energy-efficient controLED technology, the driver has four channels. Each of these four channels can dim up to 70 Watt and each corresponds to a DALI device or a DMX channel." Power is supplied using commercially available, high-quality switching power supplies.

DALI is the industry standard in Europe for digitally dimmable lighting systems, particularly for indoor lighting. DMX on the other hand is frequently used for show and entertainment lighting. Schulz explains: "Implementing the LUC04 enables our customers to access both markets, without having to significantly modify existing products." ■

Power Integrations' New HiperLCS™ High-Frequency LLC Converter IC Family

Power Integrations introduced HiperLCS, a family of high-voltage LLC power supply ICs that incorporate the controller, high- and low-side drivers, and both MOSFETs into a single low-cost package. HiperLCS ICs offer the flexibility to optimize designs either for high efficiency – with a maximum efficiency of better than 97% – or for size, by leveraging high-frequency operation to minimize transformer size and output capacitor footprint.

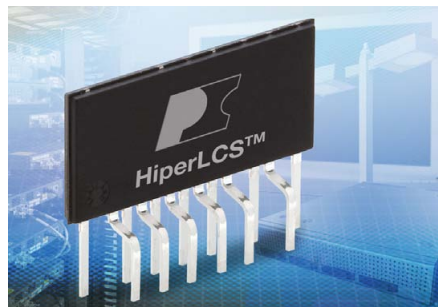

Power Integrations' New HiperLCS™ incorporates drivers and MOSFETs; saves space, cuts system cost

LLC converters have long been favored over other high-power topologies due to their high efficiency and ability to produce compact power supplies - however, designing with them is notoriously difficult. HiperLCS devices address this challenge by

A UNIVERSE OF LED MEASUREMENT SOLUTIONS

INTEGRATING SPHERES & COMPLETE SYSTEMS

StellarNet is the world-wide provider of low cost, portable test & measurement systems. NIST-Traceable spectrometers provide absolute intensity values for reliable analysis of LEDs, OLEDs, and lighting.

- Irradiance (watts/m², μwatts/cm²)
- Illuminance (lux)
- Radiant Flux (watts)
- Color temperature (CCT)
- Chromaticity coordinates x,y
- Dominant Wavelength & Purity
- Luminous flux & Luminance

www.StellarNet.us



Tampa, FL, USA +1 813-855-8687

providing all the required functions in a single IC – eliminating up to 30 discrete and passive components in the process – thereby streamlining the design cycle, saving board space, reducing assembly costs, and increasing reliability.

The high switching frequency of HiperLCS devices allows designers to use low-cost SMD ceramic capacitors in the output loop instead of bulky, unreliable electrolytic capacitors, and reduces the size of the magnetics required. It also delivers excellent transformer utilization, with a peak switching frequency of 750 kHz. Power Integrations' new thermally-efficient, low-profile eSIP™-16C package further contributes to space savings and reduces heat sink size.

HiperLCS devices have two modes of use. For high-efficiency design, its resonant control circuitry provides very low power loss, allowing designs with efficiency greater than 97% at nominal 66 kHz switching frequency. If cost and size are the determining design criteria, then high switching frequency is preferred. In this latter case, efficiency still remains high – for example, 96% at 250 kHz. ■

Microsemi: LED Driver for US LED Street Light Fixtures

Microsemi Corporation unveiled a new LED driver designed specifically for North American street light installations. The efficient LXMG221D-0700040-D2F™ LED driver eliminates bulky step-down transformers typically used in street light fixtures in these markets, providing a single-step conversion from 347 VAC or 480 VAC down to less than 57 VDC as typically required by LED fixtures.



Microsemi's new street lighting driver down-converts from 347VAC or 480VAC to less than 57VDC in a single step

Key features and benefits include:

- High-voltage AC input (347-480 VAC) for North American installations
- UL1310 Class 2 isolated compact driver solution converting 347-480 VAC to 40 to 57 VDC
- Constant current single 700 mA string applications using ~12-17 LEDs without flickering (up to 40 W output)
- High power factor (PF > 0.9) and low total harmonic distortion (THD < 15%) across the entire input voltage range at full load to meet or exceed standard requirements
- Dimmable to 10% via 0-10 V, PWM controls or potentiometers for additional energy savings
- FCC Title 47, part 15 Class B compliant
- Multiple protection features: over voltage, over current protection and automatic over-temperature shutdown to help protect the fixture investment
- Fault management feature to sense and manage failed (short and open) LED situations

Undetected and unreported non-functioning fixtures are a key issue for municipalities responsible for the illumination of public areas. Microsemi's new LED driver includes fault detection and management capabilities, which can allow operators to address this issue and respond more quickly to light fixture failures. ■

Labsphere Adds Goniophotometers to Illumination Test Range

Labsphere, Inc. announced the addition of goniophotometers to its light measurement product line. As part of a cooperative agreement with UL Verification Services Inc. of Northbrook IL, Labsphere will now promote and sell high quality Type C goniophotometers, a product which completes the company's full range of IES (Illuminating Engineering Society) LM-79 test and measurement solutions.

This award-winning test equipment will now form the cornerstone of the complete LM-79 laboratory solution from Labsphere and UL.

"UL is pleased to announce the collaboration with Labsphere," said Todd Straka, Business Development Director for UL, "We believe we can now provide our lighting manufacturing

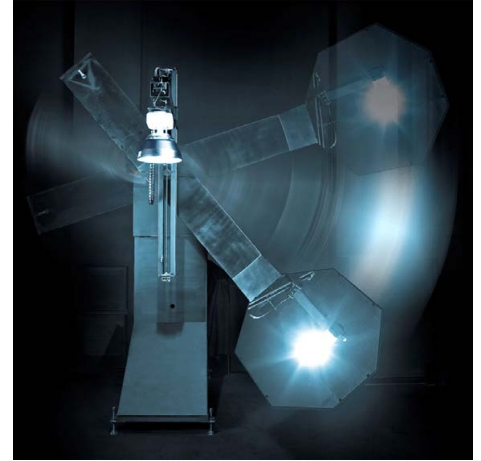

Labsphere extends product range with goniophotometers

customers with the highest quality in-house photometric test laboratories available. This relationship couples the speed and accuracy of the UL Lighting Sciences goniophotometers with high-quality Labsphere integrating spheres, spectral management accessories, and highly advanced software for a turn-key photometric testing solution." ■

Essemtec Introduces Fast Tray Changer for Cobra and Paraquada

The new TCQ automatic Tray Changer can replace a component tray in less than five seconds and align it with accuracy better than 50 µm. The 18-bin changer is available for Cobra and Paraquada pick-and-place machines. Essemtec introduces the new module at the productronica 2011 exhibition in Munich, Germany.



The new TCQ automatic tray changer is available for the Cobra (see image) and Paraquada series

We bring quality to light.

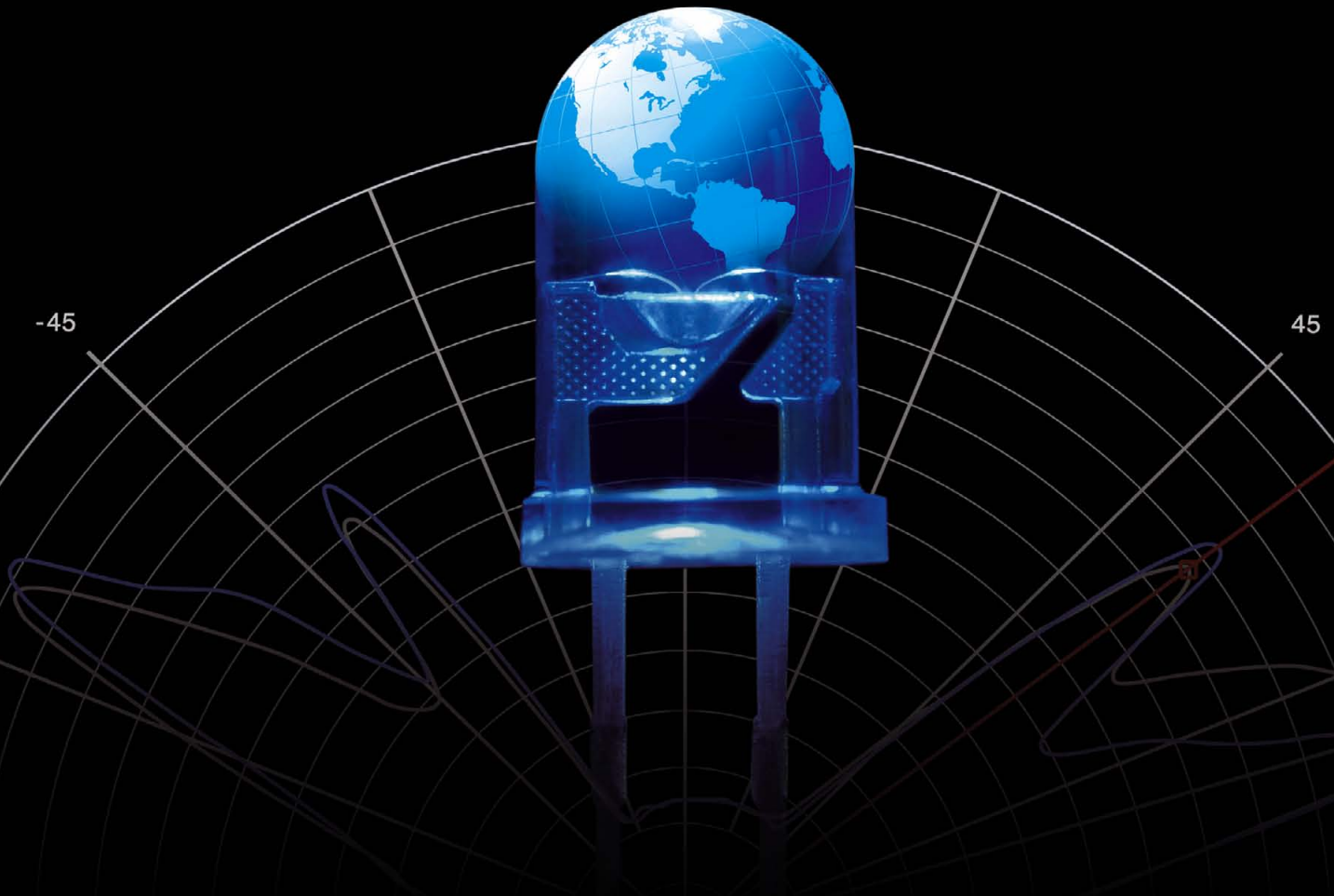

LED test & measurement solutions from the world leader

Instrument Systems continues to set the benchmark in LED metrology. Whether testing individual LEDs (standard or high-power), LED modules, or OLEDs - the global LED industry relies on us to engineer superior measurement equipment for high-speed production testing and high-performance R&D and QC applications.



Our instruments provide accurate and reliable results as per CIE recommendations and methods:

- Luminous flux [lm], luminous intensity [cd], and luminance [cd/m²]
- Chromaticity coordinates x,y,z and u'v'
- Color temperature and color rendering index
- Dominant wavelength and spectral data
- Spatial radiation pattern

 **Instrument
Systems**
light measurement

TCQ from Essemtec is a compact tray changer featuring flexibility, high speed and accuracy. On average, tray interchange time is less than five seconds and the final position of the tray is reproducible within 50 µm. This is more than sufficient even for the smallest components such as microBGAs.

Trays are stored in a magazine that is equipped with handles and can be replaced quickly. Standard magazines feature 18 or 14 slots, depending on tray thickness. Each slot has room for one standard JEDEC tray; however, the space also can be divided for several smaller trays.

Despite the high exchange speed, TCQ moves each tray carefully and reliably. Speed can be reduced for specific trays that are carrying lightweight components. TCQ is available for Essemtec's Paraquada and Cobra SMD pick-and-place machines, featuring placement rates up to 21,000 components per hour. ■

EPISTAR LAB Launched a New Platform to Achieve 3.0V White LED Chip at 1A Operation

EPISTAR LAB has developed a technology suitable for lighting applications to reach high efficacy by a single chip in size of 55mil for white LED to ease the complicated packaging of wire bonding. This technology enables a white LED with a lower voltage down to 3.0 V at 1 A operation and junction temperature of 85°C (3.2 V at room temperature).

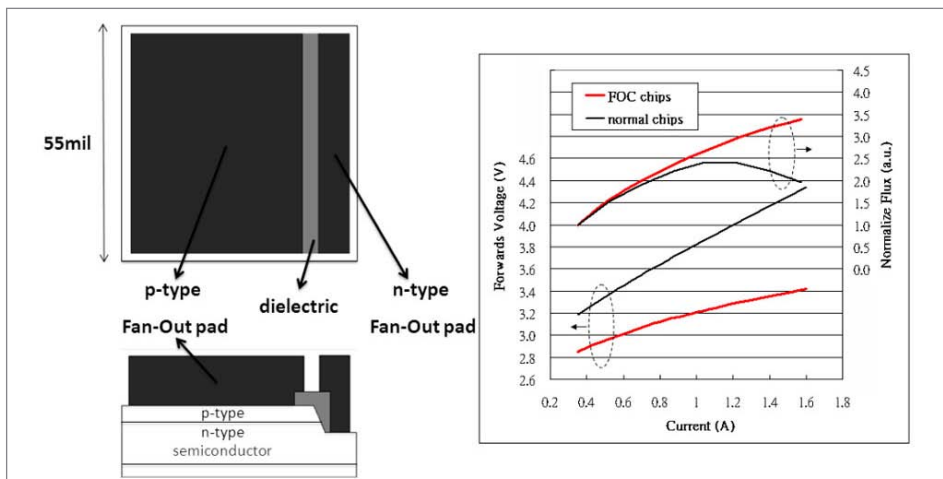

Comparison of voltage to current and of luminous flux to current between the new FOC chip structure and a conventional chip

With a correlated color temperature (CCT) of 5000 K, the LED achieves 175 lm at 350 mA. To reach such high efficacy in lighting applications, Epistar Lab developed FOC structure having a fan-out pad to significantly improve current spreading and thermal conduction. Consequently, much lower forward voltage, higher flux, and excellent flux saturation are achieved at high current operation as compared to normal power chip. FOC chips can be used in general lighting and any applications for high-efficacy white light. ■

The True Knowledge about White LEDs and Biological Clocks

Some white LEDs - which emit a spectrum of colors, including blue light at around 450 nm - are inadvertently sending signals to our brain's biological clock, which regulates daily activities. The realization of the body's sensitivity to blue light has spurred scientific research of whether the light can disrupt our circadian rhythm.

While organizations such as the International Dark-Sky Association urge caution on using white LEDs for outdoor nighttime lighting and some scientists already advocate a ban of blue-rich light for outdoor use, others estimate that the biological effects are small and caution that more rigorous scientific studies are needed before determining if white LED light has any health impacts at all.

Some scientists argue that other factors, such as sleep deprivation and abnormalities in a person's overall 24-hour pattern of exposure to light and dark, may do much more to disrupt circadian rhythms.

Epidemiological studies have linked circadian disruptions to health problems, such as cancer, cardiovascular disease, and obesity, and scientists are trying to determine if light at night - and blue-rich LEDs - are a cause. Abraham Haim of the University of Haifa in Israel considers white LEDs a form of "light pollution." "What is called 'friendly' environmental illumination is unfriendly," said Haim, who is a chronobiologist, a scientist who studies biological rhythms and cycles in animals. He has conducted studies showing that blue light can disrupt circadian-related hormones in nocturnal animals such as voles, moles and rats.

In the investigated white LEDs create a mixture of blue and yellow light that the eye sees as white. Other light bulb varieties, including incandescents and compact fluorescents, tend to produce less blue.

Until the 21st century, scientists only knew of two types of light-sensitive cells in the eye: rods and cones. But in 2001, David Berson from Brown University made a very exciting discover.

"That the eyes of mammals contain a third type of cell for absorbing light has been a very exciting discovery for chronobiology and vision research," said Jay Neitz, a professor of ophthalmology at the University of Washington in Seattle. "We always thought rods and cones were responsible for circadian rhythms and then we find there's a particular cell that sends signals to the superchiasmatic nucleus, the brain's central clock important for daily biological rhythms."

The recently discovered type of cell, called intrinsically photosensitive retinal ganglion cells, are much smaller in number than other light-sensitive cells - approximately only one of them for every million cones. But they contain a key light-sensitive protein called melanopsin which is most sensitive to light in the wavelength range between 440 and 460 nanometers and can trigger the ganglion cells to send signals to the superchiasmatic nucleus, a small brain region that regulates the body's circadian rhythms.

A study by chronobiologists in Switzerland showed that human volunteers exposed for two hours to 460 nm light at night experienced greater reductions in melatonin than when they were exposed to a higher-wavelength of 550 nm. Melatonin is an antioxidant compound that helps to protect biological molecules such as DNA.

Special: LED in a Museum Blue Light Hazard content

LED
professional
SYMPOSIUM
+EXPO
LpS 2011

Compared to conventional light sources the blue light content of LED is similar!

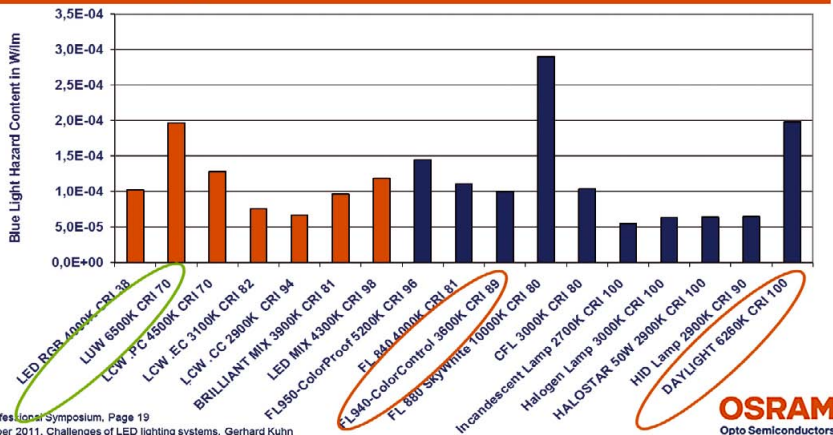

LED professional Symposium, Page 19
September 2011, Challenges of LED lighting systems, Gerhard Kuhn

Scientists are exploring the potential biological effects of LED lights, which are misleadingly accused of producing noticeably more blue than other types of bulbs, which is only true when compared to special types like HPS lamps

In the Oct. 2011 issue of the Journal of Environmental Management, Haim of the University of Haifa and his co-authors calculate that white LED light can reduce melatonin levels five times more than low-pressure sodium lamps, which produce yellow-orange colored light. They call for a "total ban of the outdoor emission of light at wavelengths shorter than 540 nm" - and to go back to older low-pressure sodium lamp designs - "to reduce the effects of decreased melatonin production and circadian rhythm disruption in humans and animals." They also call for increased consumer awareness and for bulb producers to state the wavelengths of light produced by their bulbs.

However, Rea said that it is important to find out the absolute amount of melatonin reduction, instead of the relative amount, caused by different types of lighting. Five times greater than a small amount may not be great, he said. In addition, he argued, simple calculations based on the spectrum of the light may not accurately determine melatonin reduction. Instead one must take into account other factors, such as the amount, source and duration of exposure to the light, as well as how directly it reaches the observer. "All this stuff matters in terms of predicting what effect you're going to have," he said.

Haim is aware of these factors and his team would like to follow up with controlled studies that account for them. Meanwhile,

Rea and his colleagues are pursuing research on this topic from two angles. First, they have developed a headset to measure light reaching the eye in human subjects over a 24-hour period. They call it the Daysimeter. Measuring the light that actually reaches the eye with calibrated instruments, he said, will be a key next step in getting answers on the effect of light on health problems.

In addition, Rea and colleagues have developed a physiological model of how light reaching the retina is converted into nerve signals that reach the circadian system.

Previous research has established that the degree to which nerve signals stimulate the circadian system determines how much melatonin is reduced. The model accounts for the sensitivity to the eye to different parts of the visible-light spectrum, and the level of light that triggers a signal to various parts of the brain. A brief flash of lightning does not trigger a signal to the circadian system, but a longer exposure to light would.

Applying this model to a hypothetical person under a white LED streetlight for one hour, Rea and colleagues calculate that one hour of exposure can reduce melatonin levels by about 3% to 8%.

Similar model-based calculations by his group show that light from computer screens and electronic devices such as tablets can reduce melatonin by 7% to 20%.

Perfection & competence

LED heatsinks from

fischer

elektronik

- versatile product range of LED heatsinks, excellent thermal geometries for natural or forced convection
- special profiles, customised machining and modifications for your specific application



Extruded profiles

compatible for all established LED-types, case profiles with integrated guide grooves

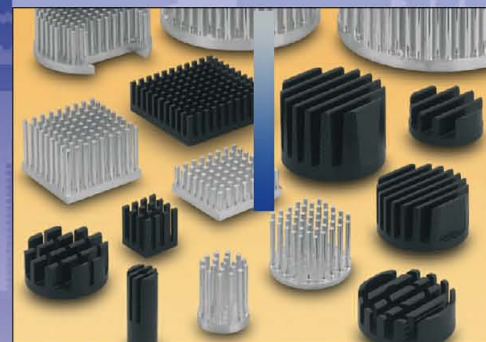

Round and pin heatsinks

aerodynamic omnidirectional fin geometry, flat LED mounting area, low weight



Customised LED heatsinks

competence in "Thermal Management" for LEDs, in-house measuring lab for thermal analysis

P. O. Box 1590 D-58465 Lüdenscheid
Nottebohmstraße 28 D-58511 Lüdenscheid
Tel. +49 23 51 4 35-0 Fax +49 23 51 4 57 54
info@fischerelektronik.de
www.fischerelektronik.de

Cases
Heatsinks
Connectors

Rea also offered another example not involving white LED light. He fitted a colleague with a light measurement device when she attended a live hockey game. According to their model's calculations, this suppressed 20 to 25 percent of her melatonin production.

Rea believes that looking at light at night alone won't answer fundamental questions about how the environment can affect the biological clock.

"You find you can't really talk about light at night without also knowing what you've got during the daytime. Taking into account the full 24 hour rhythm is essential," said Rea. "It's just too shallow to talk about melatonin suppression by 3 to 8 percent and draw any conclusions about what is going to be healthy or not healthy."

Haim calls for more detailed epidemiological studies that explore relationships between nighttime light and health problems, by following large populations over long periods of time. He calls for more studies of animal models that would look for biological effects of light.

Rea suggests moving beyond epidemiology. He suggests making detailed measurements of people's actual 24-hour light exposure and then designing experiments that create similar light-dark patterns for animals. Then, he said, you could test the hypothesis of whether the light-dark pattern causes health effects.

Absent definite answers at this point, Rea advised that people keep a fairly consistent 24-hour schedule when possible, which may be the safest way to keep the circadian system in a regular rhythm and not contribute to any possible adverse health effects.

And there are technological solutions. Wendy Davis, a vision scientist at NIST, said that it is possible with LED technology to create "tunable" light, so that it would produce blue-rich light during the day and blue-poor at night. But whether this will be necessary remains to be seen.

"There is not enough research in circadian disruption to have a position other than we support good, intelligent, properly executed research, and when it's done, we'll review it and see if we need to change anything or what needs to be done," said Alex Boesenberg, manager of regulatory affairs at the National Electrical Manufacturers Association. ■
(Credits: Ben P. Stein - Inside Science News Service)

Competing LEDs: High-quality White Light Produced by Four-Color Laser

The human eye is as comfortable with white light generated by diode lasers as with that produced by increasingly popular light-emitting diodes (LEDs), according to tests conceived at Sandia National Laboratories.

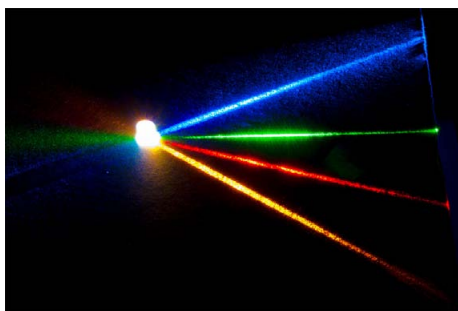

Four laser beams — yellow, blue, green and red — converge to produce a pleasantly warm white light (Photo by Randy Montoya)

The finding is important because LEDs lose efficiency at electrical currents above 0.5 A. However, the efficiency of a sister technology — the diode laser — improves at higher currents, providing even more light than LEDs at higher amperages.

Little research had been done on diode lasers for lighting because of a widespread assumption that human eyes would find the light unpleasant. It would comprise four extremely narrow-band wavelengths — blue, red, green, and yellow — and would be very different from sunlight, for example, which blends a wide spectrum of wavelengths with no gaps in between. Diode laser light is also ten times narrower than that emitted by LEDs.

The tests took place at the University of New Mexico's Center for High Technology Materials. Forty volunteers were seated, one by one, before two near-identical scenes of fruit in bowls, housed in adjacent chambers. Each bowl was randomly illuminated by warm, cool, or neutral white LEDs, by a tungsten-filament incandescent light bulb, or by a combination of four lasers (blue, red, green, yellow) tuned so their combination produced a white light.

The experiment proceeded like an optometrist's exam: the subjects were asked: Do you prefer the left picture, or the right? All right, how about now?



In the test setup, similar bowls of fruit were placed in a lightbox with a divider in the middle. In this photo, the left bowl was illuminated by a diode laser light and the other was lit by a standard incandescent bulb. The aesthetic quality of diode laser lighting compares favorably with standard incandescent lighting (Photo by Randy Montoya)

The viewers were not told which source provided the illumination. They were instructed merely to choose the lit scene with which they felt most comfortable. The pairs were presented in random order to ensure that neither sequence nor tester preconceptions played roles in subject choices, but only the lighting itself.

Each participant, selected from a variety of age groups, was asked to choose 80 times between the two changing alternatives, a procedure that took ten to twenty minutes. The result was that there was a statistically significant preference for the diode-laser-based white light over the warm and cool LED-based white light, but no statistically significant preference between the diode-laser-based light and either the neutral LED-based or incandescent white light.

Diode lasers are slightly more expensive to fabricate than LEDs because their substrates must have fewer defects than those used for LEDs. Such substrates are likely to become more available in the future because they improve LED performance as well.

Also, while blue diode lasers have good enough performance, performance of red diode lasers is not as good, and yellow and green have a ways to go before they are efficient enough for commercial lighting opportunities.

A competition wouldn't have to be all or nothing. Instead, a cooperative approach might use blue and red diode lasers with yellow and green LEDs. Or blue diode lasers could be used to illuminate phosphors. ■

Colorimetric and experimental guidance was provided by NIST. The work was conducted as part of the Solid-State Lighting Science Energy Frontier Research Center, funded by the U.S. DOE Office of Science. - Originally published in the July 1, Optics Express

LED | SYMPOSIUM
professional | +EXPO

LpS 2012



CALL FOR PAPERS
www.lps2012.com

LED Lighting Technologies

International Winning Approaches

25-27 SEPTEMBER 2012 | BREGENZ | AUSTRIA

CONTACT: LUGER RESEARCH | Moosmahnstrasse 30 | 6850 Dornbirn | T +43 5572 39 44 89 | F +43 5572 39 44 89 90
info@lps2012.com | www.lps2012.com

e.lumix[®]
Technologie AG

OSRAM
Opto Semiconductors

TRIDONIC
▼ enlightening your ideas

LED professional Symposium +Expo 2011 Fascinated LED Lighting Specialists from All Over the World

Arno Grabher-Meyer from LED professional gives an overview of the lectures and exhibition at the first LED professional Symposium +Expo - LpS 2011 - held in Bregenz.

The LED professional Symposium +Expo was held for the first time in Bregenz at the impressive location of the "Festspielhaus" and was an overwhelming success. It met or surpassed all expectations by bringing together technicians from all over the world to discuss many LED lighting topics like dies, thermal management, electrics and optics. Over 700 experts from all LED lighting technology fields attended the event from September 27th to 29th.

Top class contributors presented 24 lectures in seven sessions, covering all the relevant technologies and impressing the attendees with their expertise. These speakers came from central Europe (A, CH, D, GB, H, I, NL, RO) Israel, Taiwan and the USA. The participants agreed with the statement: "These three days have set the course for the future of our illumination technology and established relations which - no doubt - will significantly shape the lighting solutions of tomorrow."

Fascinating Opening Session with Stirring Key-Note Speeches

The symposium was inaugurated by Siegfried Luger, and the exhibition was officially opened by the President of the Vorarlberg State Parliament, Dr. Bernadette Mennel. The LpS convention and trade fair offered a symposium with numerous lectures presented by international experts. On the other hand almost 60 companies from all over the world – including world market leaders such as Osram, Avago Technologies, e:lumix, Tridonic, Philips Lumileds, Cree, Everlight, Recom and many more – presented their latest LED-technology products.

Three top notch key note speeches were held by Klaus Vambersky, Dr. Gerhard Kuhn and Prof. DDr. Sergej Ikovenko. All three speakers pointed out that for the first time in the history of this industry, with LEDs, luminaire manufacturers are facing a dramatic change to their businesses. While up until now each new light source outperformed its predecessor from the beginning, LEDs were not competitive at the beginning. However, technology rapidly advanced and began to outperform the other light sources, and this trend will continue. This is just one reason why the lighting industry has changed so dramatically.

Figure 1:
An expert audience brought high quality leads for the 54 exhibitors and provided ideas for in-depth and knowledgeable discussions

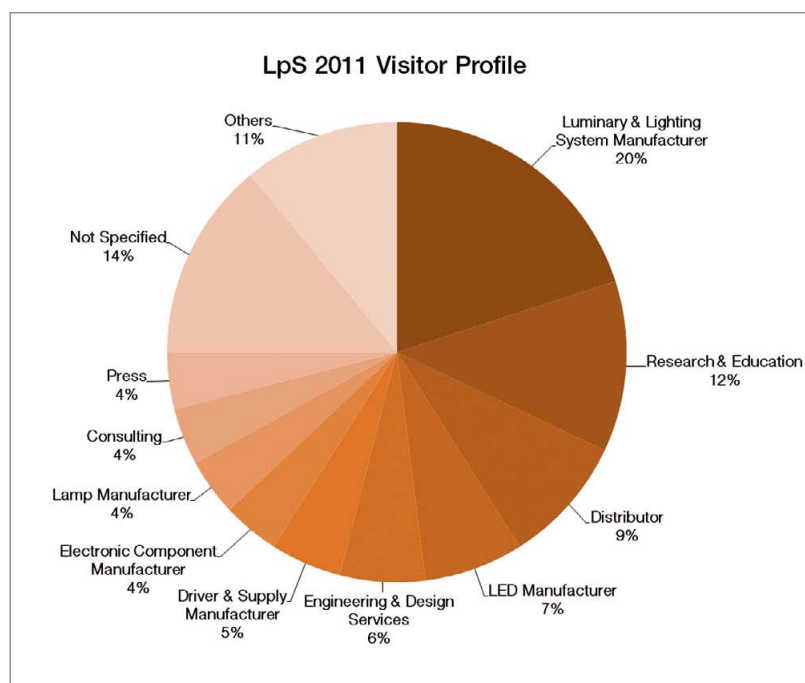

Figure 2:
The opening ceremony began with a mesmerizing LED light show performed by the Festspielhaus Bregenz showing off their creativity and perfect control of the state-of-the-art technical equipment



Klaus Vambersky presented eight challenges which are more or less new to the lighting business: Speed, cost, globalization, IP, binning, quality, thermal management and new competitors. But he also pointed out five new opportunities for the lighting business: Form factor, efficacy, color & spectra, enhanced optics and new applications. He explained these challenges and opportunities in detail and emphasized that quality has increased the interaction between light, perception and influences on the human physiology with this new light source. This issue has existed for

some time with other light sources but never before has it stood out to such a great extent. These issues are both a challenge and an opportunity.

Dr. Kuhn highlighted the importance of a correct product choice for an application and the chance to differentiate with a proper choice and product design. He explained how LEDs allow for application specific variations in light quality which were not possible before and that even today LEDs can be cost competitive in a broad range of applications when applied correctly.

In his speech, Dr. Ikovenko made it clear why the LED technology causes these challenges and provides the opportunities outlined by the earlier speakers. He also referred to the S-curve evolution of technical systems, explained the typical stages and its indicators, and then the audience learned which stage of evolution current LED technology is in. In addition, based on rules for the early stage two, he gave some hints about future development options. These options were later underlined by the solutions and roadmaps presented by different speakers throughout the symposium.

Figure 3:
Joined by Sigi Luger, the key note speakers, DI Klaus Vambersky, Dr. Gerhard Kuhn and Prof. DDr. Sergej Ikovenko, answered questions after their lectures from an audience of about 300 technicians and decision makers



Figure 4:
The Get Together buffet provided an opportunity for the symposium attendees to discuss various issues with the exhibitors



Afterwards, the “Get Together Buffet” was a great place to get a first glimpse of and discuss the products displayed by the 54 exhibitors. The delicious food and exquisite venue created a pleasant atmosphere.

Inspiring High Class Workshop

Of course the workshop on “Winning Approaches in LED Lighting - Disruptive Innovation Technology” was a highlight of the event. DDr. Ikovenko showed how to identify hidden (latent) MPV that the consumer does not verbalize, one of the most important objectives from a business perspective. If such an MPV is determined it can be the basis for a new business platform. The participants discovered the major direction of latent MPV. The seminar was full of examples from the LED

lighting area as well as from other engineering fields and brought a deeper understanding as to what and how to improve LED lighting systems. One insight that was a surprise to some of the attendees was that at its current stage, disruptive innovations are not a requirement but rather, incremental and substantial steps will do well. This workshop was taught by Jamie Fox who gave an overview of the latest market figures and some market requirements.

A Wealth of Information for LED Specialists in Seven Sessions

During the next two days specialists in the various fields of LED lighting technologies presented some very exciting insights into their work. In the “LED Lighting Technologies” sessions, Dr. Decai Sun from Philips Lumileds and Mitch Sayers from Cree Europe presented the strategies and technical ideas of their companies to make lamp and luminaire development easier and more convenient for their customers. Thomas Uhrman presented novel opportunities for the integration of additional functionality while saving costs based on wafer level packaging. Thomas Zabel, e:lumix LED

Technologie GmbH, attracted a lot of attention when he presented his novel approaches to improve efficiency using a driver technique called Enhanced PWM and to overcome the hot spot problem effectively by introducing a protection layer on the LED chip. However, he was reluctant to provide details of his company’s driver technique, due to ongoing patent applications. He also presented an alternative approach for a more durable and stable, highly efficient phosphor based on silizane technology. Christian Sommer from the Joanneum Research presented the results of a study on the impact of phosphor properties on light quality and concluded that the white light quality and the correlated color temperature of phosphor converted LEDs are strongly influenced by the shape, distribution and the compositional parameters. He also showed that for smaller color tolerances like MacAdam step 2 the requirements on the phosphor’s properties and the accurate binning of the LEDs are very high. Prof. Ku Chin Lin from the Kun Shan University, Taiwan, showed a highly sophisticated iterative solution for the optimization of color rendering for four color light mixing.

Figure 5:
The workshop with DDr. Ikovenko provided many topics for conversation



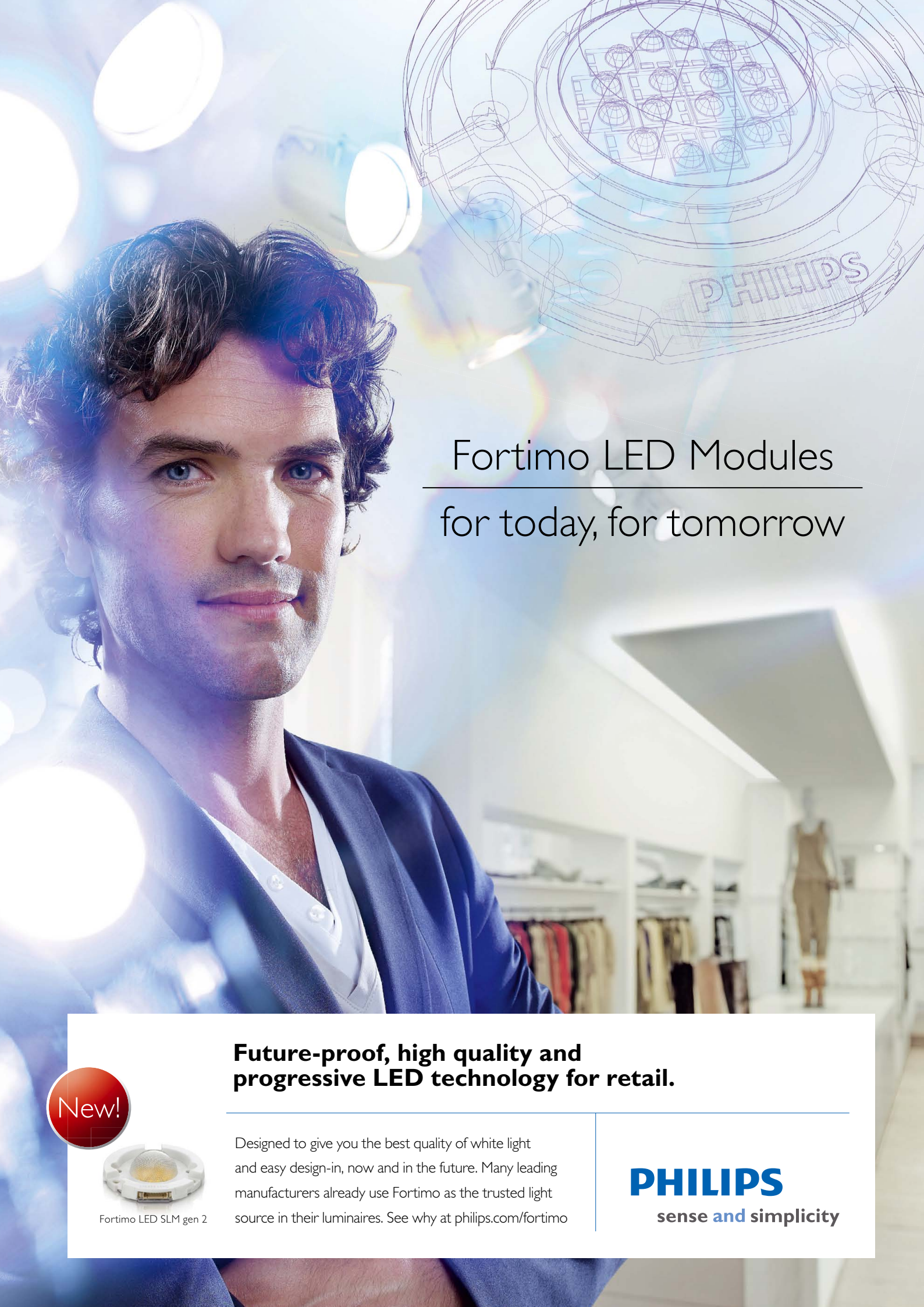

Fortimo LED Modules for today, for tomorrow

Future-proof, high quality and progressive LED technology for retail.

New!



Fortimo LED SLM gen 2

Designed to give you the best quality of white light and easy design-in, now and in the future. Many leading manufacturers already use Fortimo as the trusted light source in their luminaires. See why at philips.com/fortimo

PHILIPS
sense and simplicity

Figure 6:
The lecturers also discussed their most recent insights, from left to right: Luca Meneghetti, Christian Véron and Andrew Dennington



Figure 7:
The speakers presented new approaches just coming out of the lab, providing some future perspectives as well as practical improvements that ease the development of products for the luminaire manufacturer



Figure 8:
An audience of over 300 technicians and decision makers attended the key note speeches and the seven technology sessions



The “Optical Component Session” impressed all attendees with strong practice-oriented contributions. Luca Meneghetti from Khatod Optoelectronic opened the session with his overview on optical systems, design methods and the solutions for street lighting issues. Then Christian Véron from Zett Optics demonstrated that each optical system has its own set of critical parameters that may influence performance dramatically, resulting in the key message: take into account the time for tolerating in projects. Andrew Dennington from Polymer Optics concluded his presentation by saying that the advantages of using free-form optics in wide area illumination are significant. He showed that free-form optics allows luminaire manufacturers to significantly increase the efficiency and quality of their products, but he also pointed out: “They are not without their own limitations and understanding how to get the best from them is vital.” Individually tailored free-form optics was the topic of OEC’s Dr. Angelika Hofmann. She also compared different production methods and pointed out: “Tailored freeform optics can be economically produced – even in low volumes as



Fortimo LED Modules for today, for tomorrow

Future-proof, high quality and progressive LED technology for hospitality.



Designed to give you flexible warm white light, now and in the future. Many leading manufacturers already use Fortimo as the trusted light source in their luminaires. See why at philips.com/fortimo

PHILIPS
sense and simplicity

Figure 9:
Close-up of
Tridonic's COB
LED module using
white and red
LEDs for high CRI

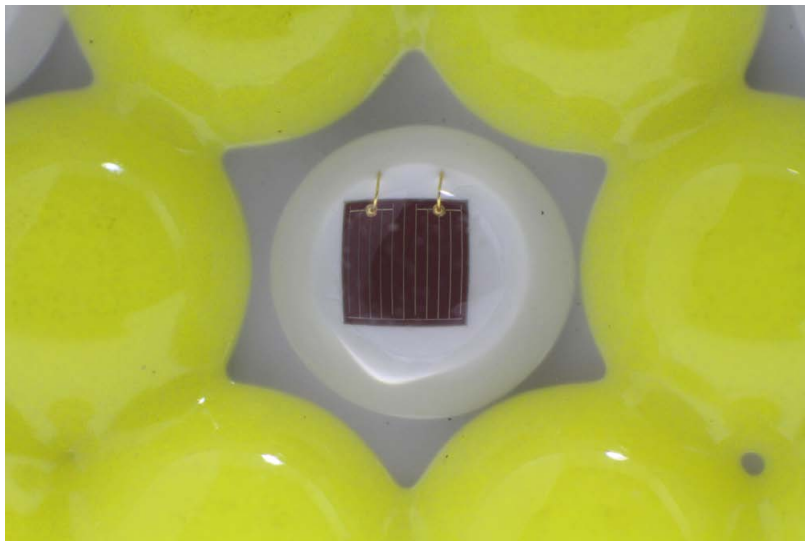

well as for mass production.” In addition, she demonstrated the unique light distribution opportunities of this technology.

The final session of the second day dealt with “Electronic Components”, mainly driver issues and very versatile topics. Francesco Ferrazza from STMicroelectronics presented an approach for a reliable and cost effective retrofit application. The primary side regulated quasi resonant flyback converter is the best choice when the available space is restricted and a long lifetime (MTBF) is mandatory. “Spectral Tuning for White LED-based Luminaires” was the topic of Alfred Hesener from Fairchild Semiconductor. He proposed a solution for more sophisticated applications where, on the one hand, color consistency over lifetime is relevant and on the other hand, color variations due to binning tolerances of LEDs can be eliminated. He pointed out the critical design issues of such a system. Paul Fleming from Mean Well Europe gave design and selection advice for LED power supplies. He showed the trade-off between all requirements from costs over reliability, efficiency and dimming accuracy clearly. In the final speech of the day, Stefan Hoerth from Haeusermann demonstrated electronics manufacturing skills at its best. He showed 3-dimensional solutions based on copper plated FR4 PCBs without compromising thermal management issues. He concluded that the

presented technology would allow the realization of challenging requirements like individual thermal concepts, innovative optics and designs, intelligent lighting control and reliable systems with a long lifetime.

Day three started with the hot topic of metrology and testing. Peter Laepple from Instrument Systems demonstrated that the spectral distribution of the LED emission makes it a very special kind of light. As a result, for an accurate measurement, not just the correct equipment but also the thermal properties of LEDs and the individual angular characteristics have to be taken into account. Juergen P. Weisshaar from Opsira presented applications where multi-color LED systems, and especially color tunable white light systems, are essential. He explained why calibration is inevitable and demonstrated a method of how to do it quickly and precisely based on a CCD array spectrometer and an imaging photometer. András Poppe from Mentor Graphics explained the difficulties and needs for proper JEDEC JESD51-1, CIE 127-2007 and LM-80 testing, and especially the problems related to the “AC thermal impedance”. In addition, the merits of capturing real transients of the junction temperature were shown to help structural analysis. Marcel Freiermuth from Essentec presented the innovative opportunity of automated 3-D component assembling and explained the freedom for new design options.

Session 6 on LED Lighting Systems was opened with an overview on system evolution given by Stéphane Vasse from Tridonic, who pointed out that the recent technical development in this sector is strongly driven by cost effectiveness and an adequate payback period. Uri Neta, a lighting consultant, presented his development of a stackable module which allows for extremely high lumen packages without compromising thermal management, efficiency and module size. He stressed the narrow beam angle and multi-color options of this novel design are especially important. Prof. Joerg Baumgart from the University of Ravensburg-Weingarten presented the research and measurement service opportunities in the LED lighting domain of Universities and Universities of Applied Science in the region.

The final session completely focused on Standardization and Reliability issues. Martina Paul, representing CIE explained the objectives of CIE and especially the role in the standardization process. She also gave insights into status of the recent standardization and certification programs like the QuaLight certificate. Dr. Matei Stelian from Electromagnetica, in his speech on “Challenge of Standards and Norms for White LED Systems”, criticized that luminaire manufacturers as well as LED manufacturers or LED module manufacturers don't measure and publish product data under comparable conditions, which is just one of a number of problems. In addition he finds it even more questionable that SSL products fall into three basic categories and that the absence of a consistent standardization may possibly obstruct the LED's success in the lighting community. One reason is that the borders between light source, lamp and luminaire are blurred with the introduction of LEDs. The last lecture was given by Reinhard Pusch from RoodMicrotec who explained how to interpret datasheets and to make an adequate choice of the LED light source for an application. He also went into detail about degradation behavior and lifetime testing like humidity or temperature cycle tests.



Fortimo LED Modules for today, for tomorrow

Future-proof, high quality and progressive LED technology for outdoor.



Designed to give you the best LED performance with high quality of white light, now and in the future. Many leading manufacturers already use Fortimo as the trusted light source in their luminaires. See why at philips.com/fortimo

PHILIPS
sense and simplicity

Figure 10:
White array LEDs
in a broad range
of power ratings
(e:lumix)

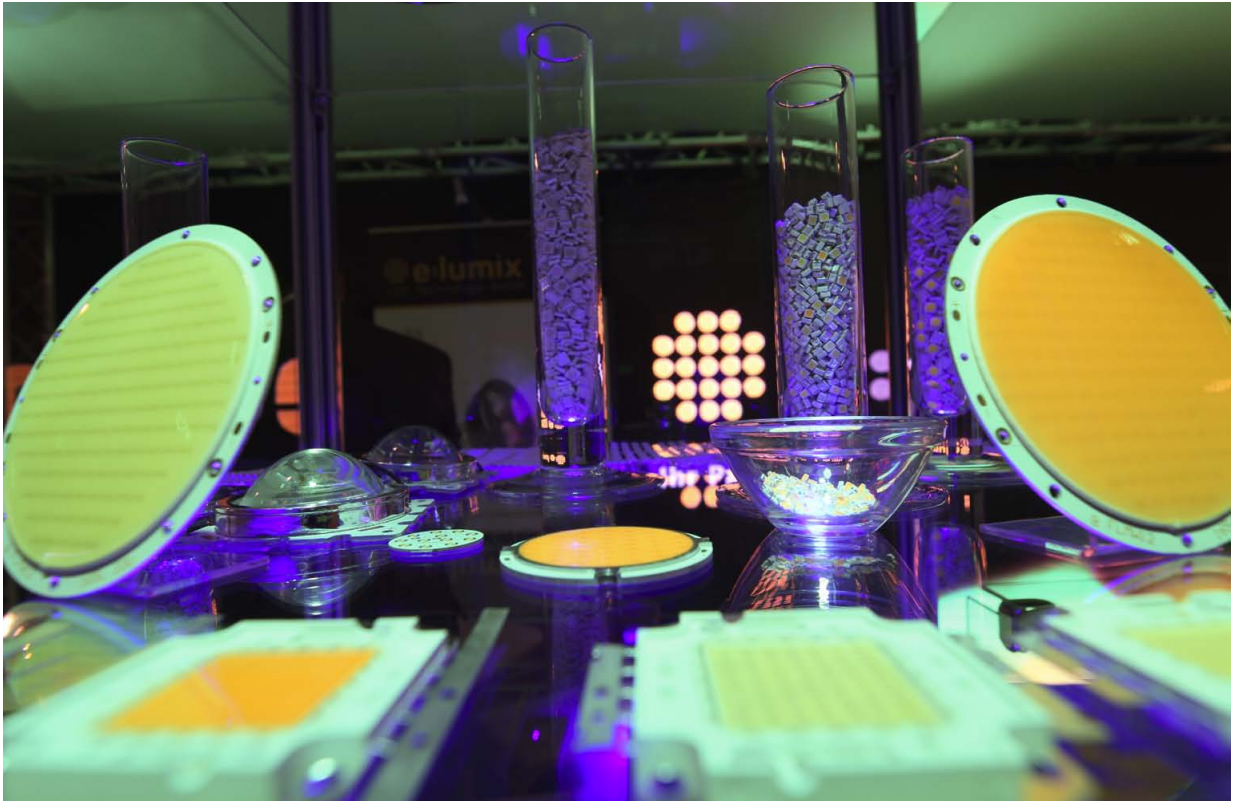

World Class Showcase of High End LED Products

During the well balanced breaks, the attendees mixed with the exhibition visitors to get in touch with the exhibiting companies, who were showing their most recent developments. From components to application, LED lighting technology was present in all its facets.

The seven distributors, Arrow Electronics, Emtron, MSC, Holders Components, Neumueller, Farnell, Beck, Glyn, Silica and Simos presented highlights of their huge

portfolio of components for the LED lighting industry, from thermal management products to driver ICs and drivers and LED optics. As the direct interface to the luminaire, electronics and module manufacturers, they also demonstrated their competency in consultancy services for the industry, which ranges from online tools to simplify the right product selection for a project or calculate the main parameters for an electrical, thermal or optical design to electrical, thermal or optical simulations or even a complete layout service for electronics.

The most important LED manufacturers were present in either with their local distributor like Seoul Semiconductor and Sharp or with their own booths like Avago, Cree, e:lumix, Everlight, Osram and Philips Lumileds. Some of these companies have expanded their business by way of a greater vertical integration during the last few years. They not only presented the most recent generation of LEDs but also modules and complete luminaires and LED systems. Everlight, for example, brought its luminaire brand, Zenaro and the road show bus. Osram demonstrated their competency in supporting manufacturers to implement LEDs in their products properly by exhibiting end-products as well as their product portfolio. The newcomer e:lumix showcased their proprietary technology and a broad range of products from low-power to high-power LEDs, flexible LED strips, different modules and an AC luminaire. Even lab samples were presented to the visitors like the next generation EPWM-LEDs where, according to e:lumix, a special die structure eliminates external EPWM driver electronics. Finally, Avago, Cree and Philips Lumileds mainly concentrated on their core competency and

Figure 9:
The highly knowledgeable attendees in discussion with the exhibiting specialists from Texas Instruments





Fortimo LED Modules for today, for tomorrow

Future-proof, high quality and progressive LED technology for offices.



Designed to give you the highest energy efficiency and comfortable white light, now and in the future. Many leading manufacturers already use Fortimo as the trusted light source in their luminaires. See why at philips.com/fortimo

PHILIPS
sense and simplicity

Figure 11:
Osram's strategy was to demonstrate the capability of the LEDs in various applications



Figure 12:
Khatod optics for street lighting applications



Figure 13:
Thermal solutions and packaging materials for LEDs were also part of the exhibition

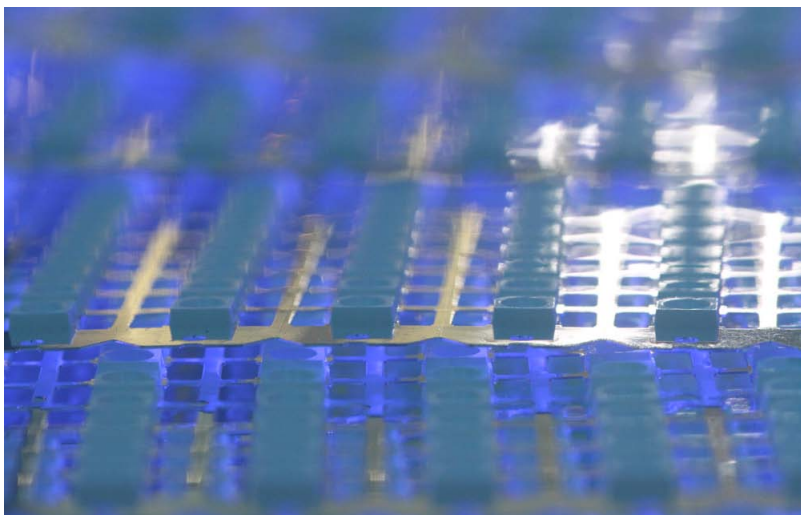

showcased their LEDs for lighting applications, each one highlighting their own particular strength. Avago, for instance, emphasized their color and multi-color LEDs, while Lumileds explained the advantages of the recent generation of products incorporating Lumiramic technology, and Cree demonstrated their LED platform strategy to accommodate the different quality and cost requirements for the best possible lighting applications.

While some optics manufacturers like Ledlink or Carclo were represented by their distributors, Khatod showed up with the whole range of innovative optics, like the Dark Lens, a first-of-its-kind anti-glare reflector and the newly introduced Nactus 101, a multi-lens array system for 6 to 24 – 36 – 48 optics designed for street lighting with high power LEDs.

Providers of thermal transfer materials to heat sinks, passive or active cooling solutions, shared their knowledge of thermal management with the visitors. Bergquist came with a broad range of products, Sil-Pad thermally conductive interface materials, Gap Pad electrically insulating and non-insulating gap fillers, Hi-Flow phase change grease replacement materials, Bond-Ply thermally conductive adhesive tapes, and the Thermal Clad insulated metal substrates. Brytec featured the Sunon fan and cooling modules for active cooling and Thoptec fan mounting accessory, but also passive cooling solutions and thermal design services. Kunze's presentation put emphasis on their high class thermal interface materials and the German heat sink manufacturer Pinbloc brought their latest generation of round heat sinks especially designed for LED products with them.

Driver IC manufacturers Fairchild, NXP, STMicroelectronics and Texas Instruments presented the most recent developments in driver ICs to the visitors. Advanced topologies and methods for dimmable off-line driver solutions for replacement lamps were discussed intensely. Products that allow a reduced component count and concepts that allow elimination of

Figure 14:
Recom also provided insight into driver details, showing the assembled PCB



Figure 15:
Haeusermann's FR4 based 3-D PCB allows cost effective advanced luminaire designs

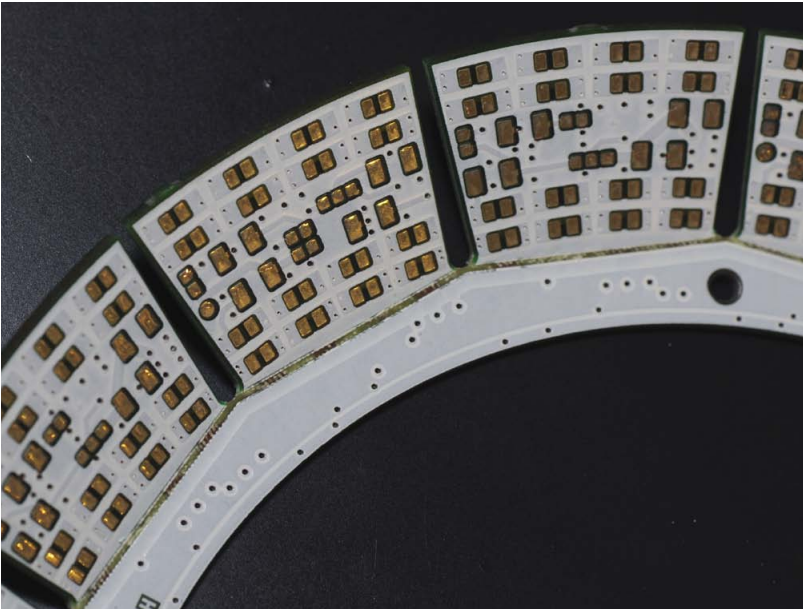

Figure 16:
Testing equipment for various tasks was presented by a number of suppliers. Among them, GL Optic



lifetime critical components are the most important ones that should be mentioned. In addition, controls ICs, or interface ICs which allow advanced features were a major topic. Wi-Fi or Blue Tooth communication for controls was addressed as well as DMX or DALI solutions.

Luminaire manufacturers were impressed by the capabilities of several power supply, LED driver, module and OEM manufacturers at the EPS Soltec, Excitron, LM Electronic, Mean Well, Melecs, Recom, Rafi, Tridonic and VS Optoelectronic booths. While Recom and Mean Well are mostly known as traditional supply and driver manufacturers, their advanced and broad range of products both offered some very attractive LED driver solutions. In contrast, Excitron provides custom-made LED drivers. One special feature is the integrated inductor that can passively split a current generator into any number of self-balancing current generators almost without loss, which allows multi-channel drivers with extremely high efficiency over a wide operating range. LM Electronic, Melecs and Rafi all go one step further. These companies offer a broad range of manufacturing services not limited to manufacturing LED drivers or supplies. LM Electronics offers high quality LED modules, and even end-products. Melecs offers design and manufacturing services for any electronics whether driver or module. Rafi also impressively demonstrated their strength in producing custom-made products in a broad range; not only the electronics but also the final products. At their booth, they also showcased an OEM product based on a development of ETH-Zürich, the "DigitalStrom" module which allows control and switching of different loads without additional cabling - providing the comfort and opportunities of a bus system. EPS Soltec, originally a manufacturer of solar systems showed their solar-powered LED street lights and also demonstrated the manufacturing and development capabilities for custom-made LED modules. The two big players, Tridonic as well as VS-Optoelectronic are well known for their broad range of high

Figure 15:
Inspired
discussions
between visitors
and exhibitors in
the "Parkstudio"
exhibition hall



end LED modules and drivers for almost any lighting application. While Tridonic accentuated their solutions for shop lighting with high CRI modules, variable CCT modules and drivers, VS-Optoelectronic displayed their broad range of products for various applications.

For the electronics manufacturers, on the other hand, PCB and substrate manufacturers demonstrated their innovative potential to serve the LED community with high end products. Fela, Haeusermann and Heraeus, all offer unique opportunities to their customers. While Fela offers solutions from glass keyboards for controls to multi-layer metal core PCBs, Haeusermann is specialized in advanced copper plated FR4 PCBs and membrane keyboards. Heraeus improved its manufacturing services with its high class roll clad semifinished products, precision stamped parts, flexible substrates as well as metal-plastic components for packaging. It is evident that these world class companies can assist in any phase of a project.

Manufacturing, testing, simulation and engineering products and services were provided by Essemtec, GL Optic, Instrument Systems, Labsphere, Opsira and Rood Microtec. Essemtec especially demonstrated its strength as a supplier of a fully-automated electronics production line. They

highlighted the recently introduced 3-D assembly opportunity and the improved dispensers. Regarding metrology products and services, providers were present with their flagships, clearly pointing out their different strengths. Rood Microtec, well known for their competency in reliability issues, displayed their services and enlightened the visitors regarding the pitfalls of LED product design for different environmental conditions.

Carson Technology and Viribright as designated LED tubes and replacement bulbs manufacturers were seeking new distribution channels and had a lot of activity at their booths. HITA, the Hungarian Investment and Trade Agency, which featured Hungarian companies in the LED lighting business, and the China-European Business Development, which did similar work for Chinese companies were also busy. The scientific organizations, on the one hand the International Bodensee Hochschule (IBH), displayed their attempts to support and cooperate with the industry, and the Competence Center Light on the other hand, demonstrated their research activities.

In addition to the international specialist press, Yole Développement informed the visitors about their broad spectrum of technical reports at their own booth.

Final Impressions

The first LED professional Symposium +Expo, LpS 2011, closed its doors on September 29th, at 3:00 p.m. LpS 2011 presented novel approaches to the public that hadn't been seen before as well as straight forward improvements. During the symposium a powerful spirit of innovation was present when the speakers presented their approaches or exhibitors explained their products. This was seen clearly by the testimonials and responses of the visitors, speakers and exhibitors. The predominately positive feedback is a great impetus for the organizers to coordinate future LpS events. The LpS 2012 will reveal which ideas shown this year matured successfully and which products endured on the market. ■

LEDs go SMART with SCB-Technology

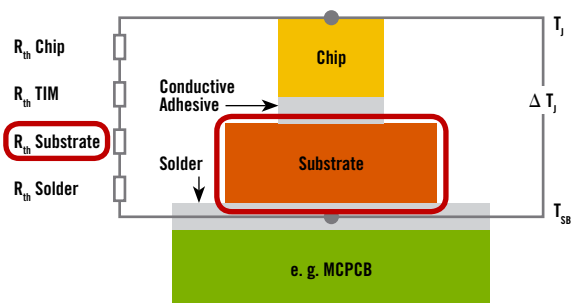

- **Stamped Circuit Board (SCB)** is an innovative solution for LED packaging substrates.
- The technology allows precise structuring and lamination of multi-layer foils in a high efficient reel-to-reel mass production.
- SCB is your alternative for ceramic LED boards providing a great thermal performance at lower costs.
- Thermal improvement of the LED substrate with high conductive materials (up to 380 W/mK) possible.

New Aspects of AC LED Technologies

Mr. Manuel Zarauza, Managing Director at Seoul Semiconductor, explained his view of AC LED technology to Siegfried Luger, publisher of LED professional, and pointed out some new aspects in the development of AC-driven LEDs. Mr. Zarauza also spoke about Seoul Semiconductor's new Z5P technology.

LED professional: What was the principal idea behind SSC starting to develop AC LED technology a few years ago?

Mr. Zarauza: We looked carefully at what the market needs were and at that time there were a lot of luminary manufacturers who didn't know much about LEDs or semiconductor technology. With a DC LED you need to have a driver, an optical lens, thermal management. In the end the whole system is quite complicated.

SSC wanted to make the application of LEDs easier for the customers and therefore, about six years ago, we started to develop AC LEDs.

LED professional: Are there specific application areas for AC LED technology?

Mr. Zarauza: It makes sense to use AC LEDs in applications where you don't have a lot of room like with MR16 lamps. Another reason might be if you don't have a lot of knowledge about driving or let's say operating a DC LED. In general, though, the major reason for using our Acriche AC LEDs is space requirements.

LED professional: Are there differences when you think in terms of the geographical market?

Mr. Zarauza: This business is really global. For example, many designs are made here in Europe but production is

in Asia. The subject of space is the same everywhere you go. The only differences are the CRI and the color temperature. In Asia, for example, they prefer more cold white while Europeans prefer more warm white color temperatures. This is also valid for standard DC LEDs.

LED professional: An AC LED is more expensive than a DC LED. Were comparisons made in relation to the overall system costs taking the driver, the PCB and so on into consideration?

Mr. Zarauza: This depends very much on the economy of scale. When the customer orders drivers in high volume then the DC LED system and the AC LED are similar in costs but the lumen output of the DC LED will be better than with the AC LED technology. So it is really strongly dependent on how much you produce and which prices you have for sourcing the components.

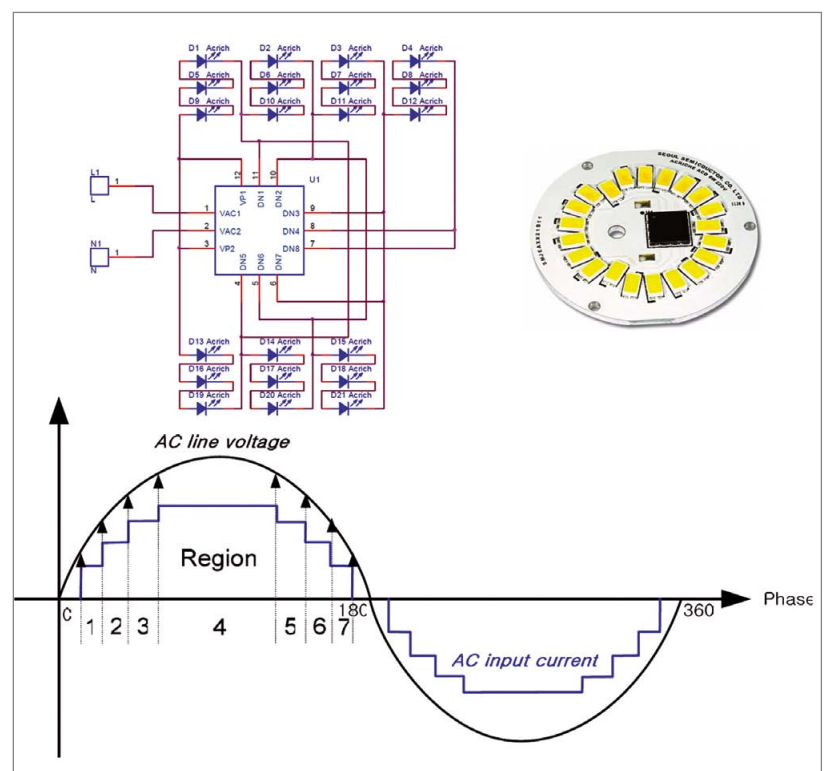

Figure 1: The high voltage controls circuit assures a proper current wave form and dimming capabilities

LED professional: One concern of an AC LED is the output light ripple. Since there is no energy storage element, the light will be modulated with the mains frequency. How do you see this?

Mr. Zarauza: We have developed a new technology where the ripple is not an issue any more. We could eliminate this ripple by applying a new technology to the second generation of the AC LED Acriche.

LED professional: Are you saying that there is no mains ripple in the light output any more based on your new technology?

Mr. Zarauza: Exactly! We were able to beat it. This technology has just been launched and is brand new. Within the LED board we have an additional component for reducing this ripple. This component is not incorporated in the SMD LED but in the LED board. We call this technology Acrich 2.

LED professional: Is there still an AC LED inside?

Mr. Zarauza: Yes, with our own SSC LED die. We are the only company in the world that produces LEDs without forward integration, meaning we do not go into the fixture or lamp businesses. The Acriche is our own die and we do not depend on any other supplier. I believe very strongly that we should not compete with our customers. This is why we are only focusing on and sticking to the LED itself.

LED professional: What is your strategy in terms of single high power LEDs in comparison to LED arrays with let's say low or mid power LEDs?

Mr. Zarauza: We started with smaller LEDs. We produce millions of them every month, for example, for flat panel applications. In this segment the price is absolutely crucial. Now we are also producing arrays based on our mid power LEDs as well.

LED professional: Will SSC go into the lamp business in the future?

Mr. Zarauza: SSC will not compete with its own customers. If you open 10 LED retrofits on the market you will find SSC products in 6 of them. The main reason is because we are not competing with our customers. We plan to continue with this strategy and not to go into any forward integration.

LED professional: I'd like to ask a question in the technology field but not directly to do with the AC LED. What about your latest development with the Z5P series?

Mr. Zarauza: On the one hand we have the typical game of increasing the lumen figures. Everybody is pointing out his latest laboratory values. Our goal is to satisfy the needs of our customers. You know in an application the junction temperature of an LED will go up from 25°C to about 80°C...100°C during operation. Normally the

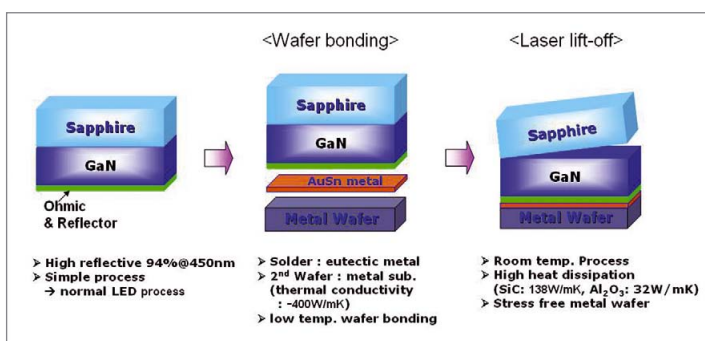

Figure 2: Another interesting product with improved temperature behaviour is the new Z5P

Protect-R-Shield Your Solution Provider

Protection for electronic circuit board assemblies and LED devices from corrosion

Moisture • Salt Spray • Chemicals • Harsh Environments • Contaminants

- Crystal clear, non-yellowing conformal coating
- Color enhanced coating material available for improved aesthetics
- Specially formulated adhesives for optical lens attachments
- Automated coating process for guaranteed consistency
- Quick turnaround

protect-r-shield®

www.protectrshield.com • tel: (888) 257-4780

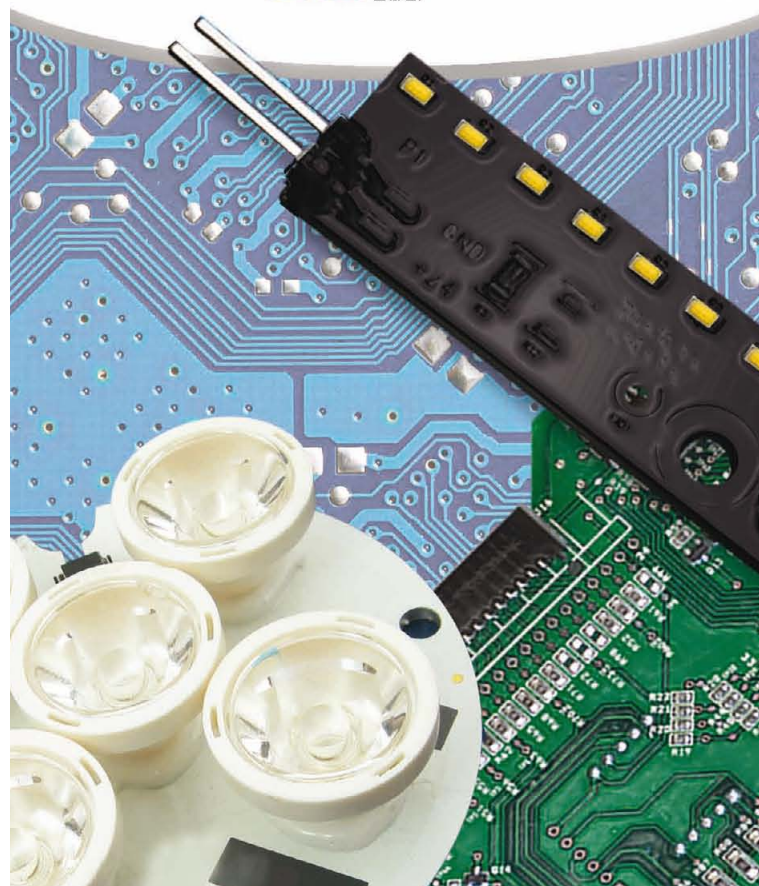



Manuel Zarauza

Mr. Zarauza is now Managing Director, and has headed all business activities in the area of automotive, SSL and the EMEA region for Seoul Semiconductor Ltd. Mr. Zarauza holds different academic degrees such as an MBA, MA, HND in Business administration and different programs in Marketing, Strategy and Finance.

LED tests made during production are made at 25°C. I said to our team: "We need to have an LED that has the same lumen output at high junction temperatures without any reductions".

Today LEDs lose about 15% to 25% lumen output when going from 25°C up to 100°C.

My goal was 0% loss but it couldn't be achieved. However, we did reach a reduction of rate of only 3-5%.

LED professional: Do you have test results to back this up?

Mr. Zarauza: Yes, of course. I asked independent institutes to analyze this. There are well-known experts who tested this LED technology and their results showed the exact behavior that we wanted to achieve.

LED professional: What was the basic improvement that led you to reach this goal? Was it the phosphor or maybe some other parts in the LED?

Mr. Zarauza: We put a metal layer inside the epitaxy so that the heat is dissipated out of the LED chip much better and faster. This technology went into mass production in August of this year.

LED professional: Many thanks for this interview!

Mr. Zarauza: Thank you. ■

4th **LED/OLED** Lighting Technology Expo

LIGHTING JAPAN

Jan. 18 [Wed] – **20** [Fri], 2012
Tokyo Big Sight, Japan

Organised by: Reed Exhibitions Japan Ltd.

Lighting Fixtures

Lighting Devices

Materials

Equipment

Components

The **BEST** platform to procure
LED/OLED Lighting Technologies & Fixtures

– **500*** Exhibitors & **32,000*** Visitors – (* expected)

An International Showcase of Lighting Fixtures
featuring Advanced LED/OLED Technologies

2nd **LED/OLED** Light Fair

Experience high-quality and high-function lighting fixtures for various applications, achieved with the state-of-art LED/OLED technologies.



Request **FREE** Invitation Tickets ▶▶ www.lightingjapan.jp/en/

THE LATEST AND GREATEST LED LIGHTING

- > A world of 10,000 LED lighting components and design solutions
- > LEDs, Power and Thermal management, Interconnect and Optic products available
- > Global portfolio of industry leading manufacturers



www.farnell.com/lighting

element14

www.element14.com



Design with the best

LED Secondary Optics Technology

Not only the efficiency of an LED is important, but the efficiency of any single component of an LED system counts. Molly Lin, Ledlink's Sales Dept. Marketing Section Manager explains what that means to a secondary optics, what are the challenges, the limitations and the opportunities.

LEDs are becoming more efficient almost month by month. But that is not enough to provide an excellent luminaire a highly efficient system. Each single component contributes to the final result, both positively or negatively. One key element is the secondary optics. With it, optical flaws of an LED can be compensated or multiplied, or the system efficiency can be improved or negatively affected. Thus, the challenges for an optics designer are manifold.

Figure 1: Impact of primary (left - Divergence of light after passing through the primary optics) and secondary (right - The secondary optics can change the light divergence angle so as to concentrate the light) LED lenses on the light distribution

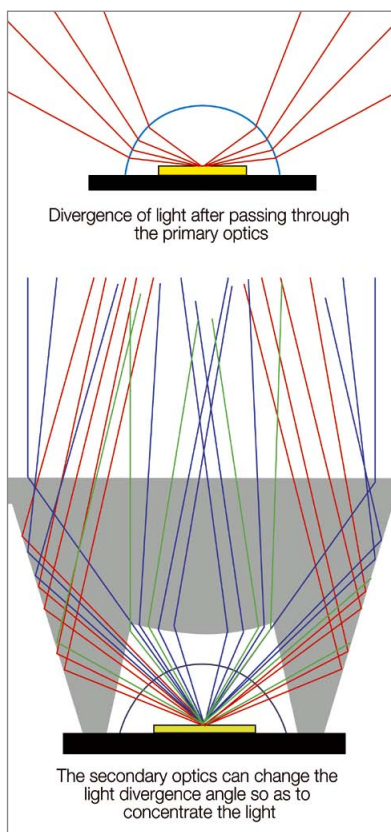

Figure 2: Some examples of secondary optics

LED Optical Design and Secondary Optical Design

Before a high-power LED lighting device becomes a lighting apparatus, there are usually two stages of optical designs. The primary optics is formed when an LED chip is packaged to form an LED component so as to solve the issues such as the beam angle, optical flux, intensity distribution, the spectral range and distribution for the color temperature to extract the light emitted from an LED chip as much as possible. The optics in this stage is called the primary optics. The secondary optics for the high-power LED is designed to pass the light that has been shaped by the primary optics through a secondary lens so as to manipulate the optical characteristics. Accordingly, the light emission from the entire lighting apparatus can be used for lighting in a more effective way.

Effect of Secondary Optics on Light Manipulation

If the design and packaging of primary optics are perfectly performed to have perfect light emission profile for each LED chip, the light extraction efficiency and optimization of light intensity distribution will have fewer constraints for the secondary optics. However, for different LED packaging technologies, different light manipulation effects may occur after the optical processing, such as the light glow, non-uniformity, yellow annular ring, etc. With properly designed secondary optics, these adverse effects can be minimized so that a better lighting effect can be achieved.

Figure 3:
Some examples of packaged LEDs flaws that can be corrected with properly designed secondary optics

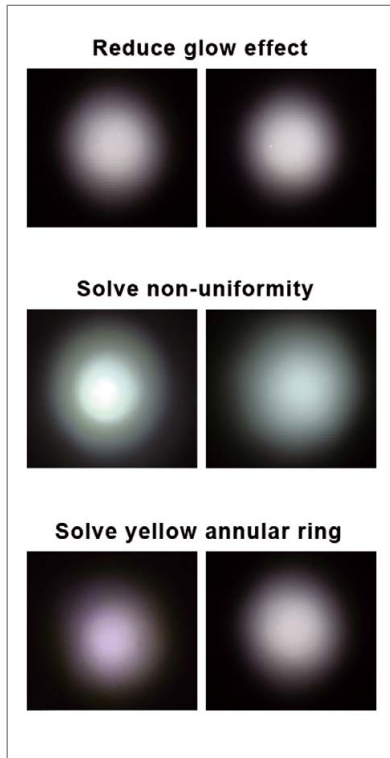

Street Light Asymmetric Design

LEDs have established themselves in the street lighting sector because of the many ways that they can be implemented. An asymmetric rectangular light spot lens for streetlights can improve lighting efficiency compared with the LED streetlights with or without ordinary reflectors with the same installation and road conditions. Ordinary LED streetlights usually have symmetrical light distribution. As the light is projected from the light source, the illumination may be evenly distributed to the sidewalk or both sides of the road. In this case, the light is unable to be concentrated to illuminate the road only. With asymmetric light distribution, the light can be illuminated more effectively toward the road.

Single-Chip & Multi-Chip LED

With the growing market demand for LED lighting, the development of light emission intensity of LEDs has also been progressive, so chip-on-board (COB) LEDs are being developed. The secondary optics design which is crucial for the development and applications of single-chip LEDs has also been developed towards

diversified applications. Additionally, the applications of COB LEDs have been gradually taken into account.

Similar to the single-chip LED, the COB LEDs may have imaging issues after the light passes through the secondary optics and the yellow ring due to the phosphor deposition during the packaging of flat-surface LEDs.

The advent of COB LEDs provides more diversified options in the LED lighting market. There is no fundamental difference between the COB and single-chip LEDs. The only difference is their application requirements. The secondary optics provides more varieties and applications for LED light sources but the corresponding design restrictions may reduce their potential for success. LedLink has developed a series of secondary optics for COB LEDs with different angular patterns to meet market demand so as to provide more choices for applications in the market.

Multi-Chip COB Lens

In addition to the issues for single-chip LEDs, the COB LEDs have other restrictions to overcome. The efficiency of the secondary optics for a typical single-chip LED can be more than 90%. For the COB LEDs, it is necessary to take more factors into consideration to achieve the same goal.

The restrictions mainly come from the configuration of multiple chips in the package. Although a larger number of small-sized LED chips can provide a larger light emission area and a further light illumination distance, it may cause other problems. For the design of the lens to meet the requirement of a larger light emission aperture, i.e., the light source has a larger light emission area; the light rays from different light sources projected to the same optical surface of the lens may be refracted to different directions so that a poorer light collection capability and optical loss may occur. In addition, if the light emission quality and intensity of multiple chips are different, the color temperature and illumination distribution of the light source may be non-uniform. These effects may significantly increase the difficulty for the design of secondary optics for COB LEDs.

The COB LED has a large light emission area, so it is difficult to design secondary optics for narrow angle applications. For example, the spot light, stage light, and wall washing lamp which require longer projection distance and a narrower angular design still require single-chip LEDs with proper secondary optics.

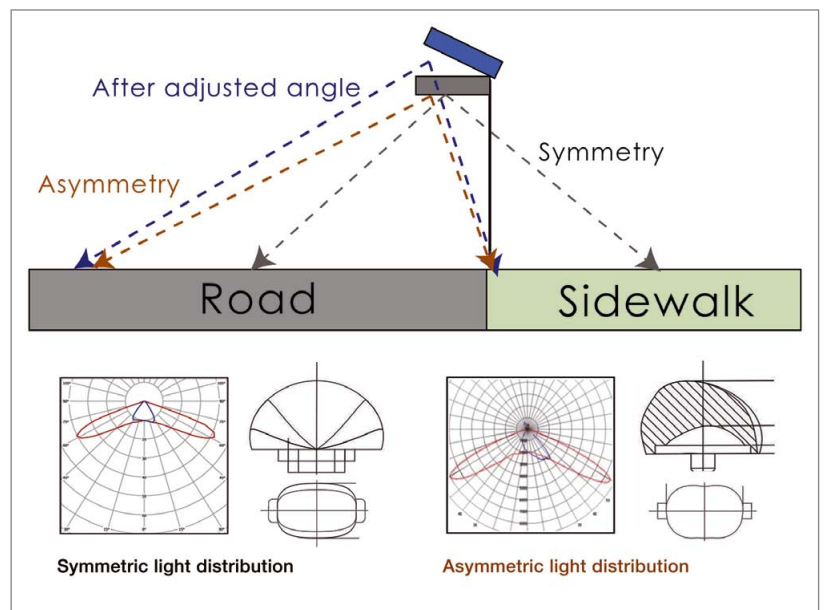

Figure 4: With the asymmetric light distribution, which can be provided by secondary optics, there is no need to shift the head of a street light anymore

Kingbright's KPHB-1608 series Bi-colour SMD-LED im 0603 package

Features:

Dimensions = 1,6 mm x 0,8 mm x 0,5 mm

Available in various colour combinations

Luminous intensity up to 230 mcd @ 20mA

By the low construction height this bi-colour SMD-LED is suited especially for backlighting at Keypads, Keyboards or LCD's



Quality — Efficiency — Innovation — First-class service

Kingbright Electronic Europe GmbH • Lindenau 7 / Gewerbegebiet • D-47661 Issum • Phone: +49 (28 35) 44 46-0 • Fax: +49 (28 35) 44 46-29

Figure 5:
Ray trace of a single chip LED package (left) compared to a multi-chip COB array LED (right)

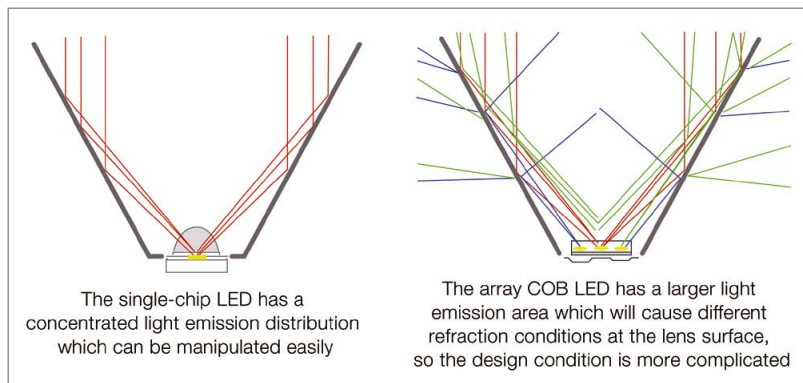

building lighting; a combo lens for mixing the light from RGB LEDs for stage lighting; various indoor lighting, flood lights, embedded lights, tube lights or factory lighting; outdoor or commercial lighting including wall-washing lights and advertizing light boxes; automotive lighting; medical and surgical lights; plant lighting; or lenses for any special requirements of angular distribution.

Materials and Thermal

Another issue for the development of COB LEDs is thermal solution. The overall power of LEDs is higher, so the voltage and current are relatively higher and the heat dissipation area is increased so as to solve the heat generated due to a higher source density. Typically, the substrate temperature is controlled below 70 degrees. In this case, the LEDs have normal efficiency. Otherwise, the overall light emission efficiency of the LED may be degraded due to accelerated aging. High quality lenses are made of optical-grade Polycarbonate (PC) and Polymethylmethacrylate (PMMA), which are resistant to a temperature of between 90 and 105 degrees. As the LEDs have normal efficiency, they will experience no thermal induced defects such as deformation, cracking, and yellowing. Ensure the optical performance of secondary optical lenses in applications.

Secondary Optical Application

With the growth of the LED lighting market, related applications are increasingly prevalent. In addition to the LED industrial trend of improving brightness, color temperature, power supply and thermal solution, secondary optics may also have a critical impact on the LED lighting applications! By using different secondary optics design, an LED can have different beam patterns, beam angles and optical efficiency so that the value of the LED light sources can be increased and a variety of lighting applications can be derived.

The range of 8 – 140 degrees for a wide range of applications; for example, lenses for the ordinary symmetrical streetlight and the asymmetrical rectangular beam pattern lens for streetlights, reducing the number of LEDs; the single lens for mixing the light from RGBW LEDs for

Benefits of Secondary Optics for the LED Industry in Environmental Protection

Nowadays, environmental awareness is growing rapidly all over the world. Although LED lighting itself is a green technology, if its light emission does not concentrate on the area to be illuminated, the unused light may be wasted. With the light re-distribution through the professionally designed secondary optics, the waste of light can be reduced and the efficiency of LED lighting can be increased which implies that the number of the used LEDs and the heat generated from LEDs can be reduced. These savings in energy reduce the cost for materials and constructions. Furthermore, the LED's benefit of environmental protection can be exerted as much as possible. ■



EdiPower® II Series & Reflectors

EdiPower® II series provides different operating powers and is offered in various colors. They serve as optical engines and can be utilized in general lighting and special lighting applications. Furthermore, the high CRI options allow the customers to optimize the effect in various fields.



EdiPower II ★



EPCx-xxxx

EdiPower II HV



EPSx-HFBx



EPSx-Vx44

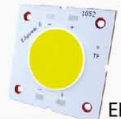

EPSx-VF0B

	EdiPower II ★	EdiPower II HV	EdiPower II HV	EdiPower II HV
CRI	80/80/80	70/80	70/75/80	70/75/80
Power	6W-10W	9W/13W	10W-15W	100W-120W
I _F (mA)	700/1000/250mA	250/350mA	1200mA	3600mA
V _F (V) (Typ.)	9.6V/9.8V/26.5V	38.5V	13.0V	33.0V
Flux(lm) (Typ.)	● 435lm ● 675lm ● 575lm	○ 970lm ○ 1380lm ● 900lm ● 1250lm	○ 1400lm ● 1190lm ● 980lm	○ 9500lm ● 8600lm ● 7300lm
Reflectors Angle(Beam)	25°/35°/50°/60°/100°	25°/35°/50°/60°/100°	25°/35°/50°/60°/100°	



1. LED is a dynamic, creative and evolving technology. Please refer to the datasheets for final specifications.
2. Other colors is available upon request.

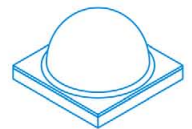

Federal FM Series

The New High Brightness Multi-chip LED



Series	Picture	Part Number	Color	Type	λd(nm) / CCT (K)	V _F (V)	I _F (mA)	Flux(lm) (Typ.)
Federal FM Series		EFE4W-1CE7	○ ● ● ●	4W/10W	W:5000~10000K	3.3/ 3.7	350/ 700	440/ 750
Federal FM RGB Series		EFERTBW-1CE1 EFERTBA-1CE1 EFERTTB-1CE1	● ● ● ● ● ● ● ● ● ● ● ●	1W/3W	R: 620~630 T: 520~535 B: 455~470 A: 585~595 W: 5000~10000K	2.1/ 2.3 3.3/ 3.7 3.3/ 3.7 2.1/ 2.3 3.3/ 3.7	350/ 700	50/ 100 80/ 125 20/ 35 50/100 105/ 180

Federal 5050 Series is a smaller and brighter multi-chip LED which provides multi-color packaging flexibility. Federal is a surface mount, compact, high brightness LED that is suitable for various illumination needs such as general illumination, ashlights, streetlights, spot lights as well as industrial and commercial lightings. The multi-color LEDs (RGBW/ RGBA) are especially suitable for stage lights, and with its smallest dimensions in the world, enables a higher flexibility for optical design.

4F, No.800, Chung-Cheng Rd., Chung-Ho Dist., New Taipei City, Taiwan 23586
T+ 886 2 82276996 F+ 886 2 82276997 service@edison-opto.com.tw

Print-Optical Technology – Manufacture LED Lenses by Stacking Droplets-On-Demand

When people hear the brand name Roland, most of them think about the company's well-known digital pianos. Roland is, however, also a leading manufacturer of large professional printers, mainly used in the graphic design industry. Richard de Vrie and Kurt Blessing decided to use these printers as the basic tools for the print-optical technology, seeing that modifications were unavoidable. How such a modified printer that bears the maxim "LUXeXceL inside" works is demonstrated.

Creating tools for producing optical components used to be very time-consuming. This irritated Richard de Vrie and Kurt Blessing enormously when they were launching LED armatures onto the market. Their obsession with solving the problem of reducing the time-to-market for components like lenses and prisms inspired their innovation: building optical parts from transparent droplets on demand (DODs). To do this, they wanted to use a professional printer, but were confronted with many problems, including the inadequate accuracy of droplet deposition. So their newly established company concentrated on modifying a printer and developing an innovative process called "print-optical technology". This term and the basic technology are now copyrighted, as are the many inventions required to make the new technology really work.

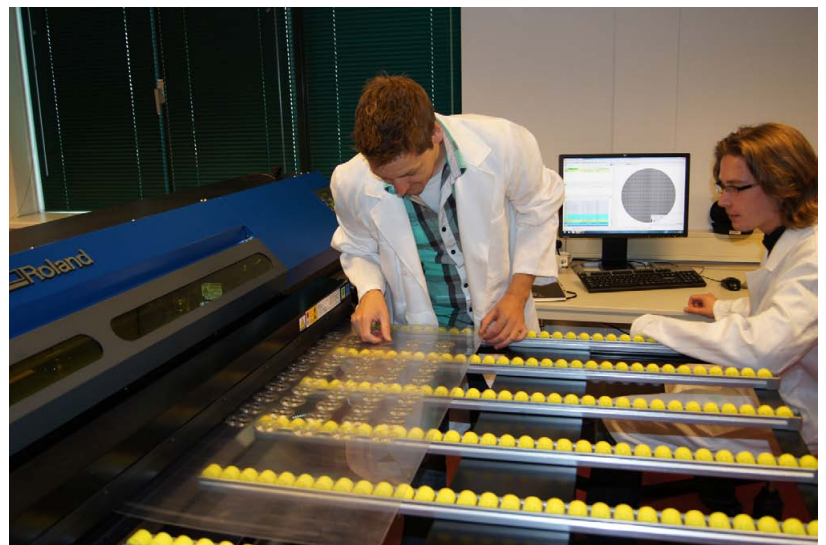

Figure 1: Making optical products with print-optical technology on a modified Roland printer. The yellow rollers are for guiding the substrate

The time and cost advantages of print-optical technology can be explained easily using the manufacture of a plastic lens with a focal distance of 50 mm as an example. When conventional injection molding is used to manufacture this optical part, the tools required cost about € 30,000 and there may be a four- to eight-month delivery time. The print-optical technology only requires about € 1,000 in preliminary costs with a one- to two-week delivery time, primarily required to create the CAM software program.

Improving Stacking Accuracy

Using a printer for more than one layer of deposited ink is not new, as special effects can be created for graphic design by using additional glossy layers. In this case, accuracy requirements are not extremely high; instead it is reproducibility that is more important. Roland specifies an absolute distance accuracy of ± 0.3 mm or a relative one of $\pm 0.3\%$, whichever value is greater. For a printing width of 1,400 mm, this means a completely inadequate accuracy of about ± 4 mm.

Figure 2:
Schematic representation of the four stages in print-optical technology:
1. Substrate
2. Spraying dots of UV-curable polymer
3. UV-LED source
4. UV beam
5. First layer of polymerized bubbles
6. Stacked layers of bubbles

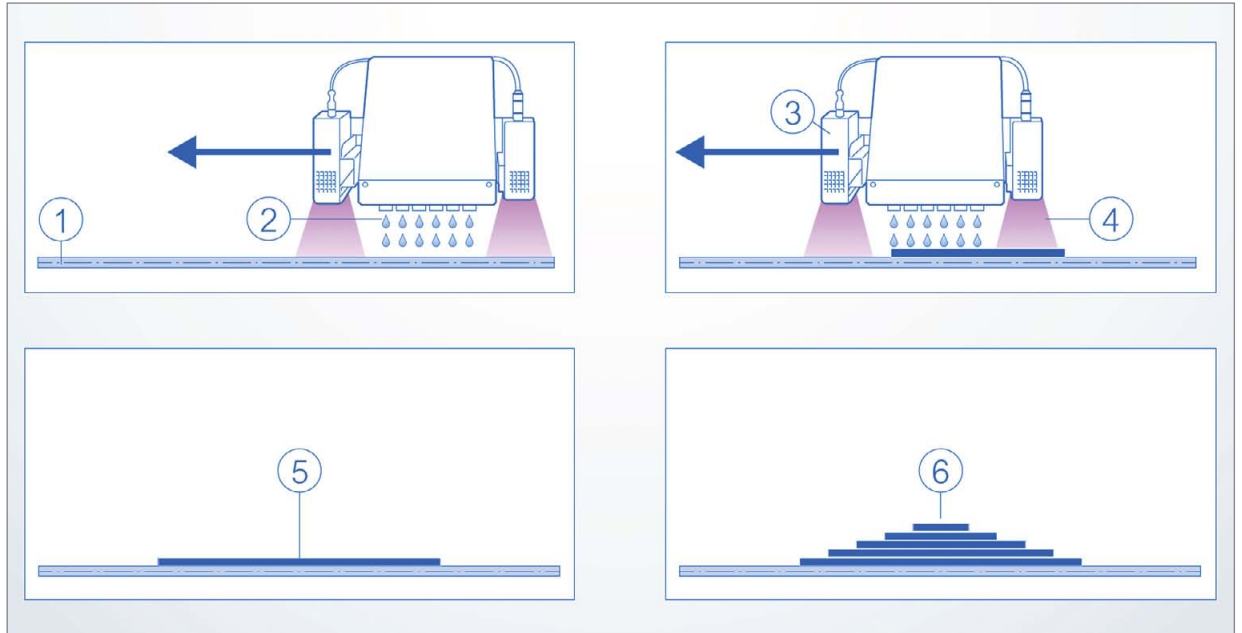

Figure 2 provides a schematic representation of the stacking of dots of UV-curable polymer in print-optical technology. A printer head ejects tiny dots and deposits them on a substrate, which is made of glass, foil or PMMA (commonly called Perspex or Plexiglas). UV light is then used to cure the dots, the process for which will be explained later on.

When stacking multiple layers of dots for producing optical components, including lenses, prisms and gratings, accuracy requirements are much higher than in graphic applications. Fortunately, adjusting successive layers by using markings – a standard practice in IC manufacturing – is not required in print-optical technology, because products are made in a single working cycle with no repositioning. Nevertheless, an optical product generally has to meet stringent dimensional requirements (Figure 3) and for the droplet stacking process to be successful, the reproducibility of droplet deposition is of utmost importance.

The details of the printer modifications are a trade secret. Nonetheless, an optical measuring scale – most likely from Renishaw – could be seen measuring the transversal movements of the print-head across the substrate. The displacement in longitudinal direction caused by driving rollers is controlled by a stepping motor with an accurate angular encoder.

Another modification concerns the maximum flat substrate length. Conventional printers are mostly used for sheets on rolls, but the modified printer is able to handle flat sheet material with a length of up to 5 m.

Droplets on Demand

The most essential component for print-optical technology is the print-head. This is a piezoelectric controllable print-head with so-called Micro Piezo Technology from Seiko Epson which provides a resolution of 1,440 dpi, which equates to a dot size of 18 μm and an approximate volume of one droplet of 7 pl (picolitre). The maximum droplet volume is 40 pl. The variation in droplet volume is due to the

variation in voltage applied to the piezoelectric elements in the print-head, which generate the ink bubbles. It is not unrealistic to expect a higher accuracy in the near future thanks to an improvement in the resolution of probably up to 2,880 dpi.

UV-curable polymers are used in the manufacture of optical components. UV light radiating LEDs take care of the radical polymerization process for building repeated layers of dots, resulting in transparent geometrical shapes. This type of polymerization utilizes free-radical building blocks for coupling monomer molecules, resulting in much larger polyacrylate molecules. A relatively high refractive index of 1.5 can be achieved.



Figure 3: Checking the quality of an optical product

Figure 4:
Printoptical lenses are already in use in linear luminaires. To provide the demanded quality, an accurate interaction between software, mechanics and UV curing LEDs is necessary



Given the discrete elementary dots, one might think that the process described would generate an uneven, bubble like structure. However, the technicians use a little trick for smoothing out this structure, thereby improving the surface quality and decreasing roughness. The secret of this technique is delaying the time between ejecting a bubble and applying UV light. This delay gives the monomer the opportunity to flow, so that the bubble loses its spherical form. Part of the innovative work is mastering this smoothing-out technique.

After the dots have been deposited and polymerized, the products have to be cut out of the much larger substrate of glass, PMMA or other transparent material. To do so, a laser has to outline a controlled movement around the contour of each single product. At present, a separate laser cutting machine is used, but, in the future, integrating the laser into the printer would be a better idea. The laser could then be mounted onto the slide for the print-head. To control the laser movements, the current software for print-head control is used, which does not require the substrate to be repositioned.

Another problem to solve was the imperfect perpendicular direction of the bubble speed when hitting the substrate, which is caused by the speed of the print-head: the speed vector of one bubble is the result of the vertical bubble ejection speed and the print-head speed. An additional complicating factor was the changing sign of this effect when the print-head returns at the end of one stroke. Software compensation provided the solution for this problem.

In addition to transparent polymer, there are print-heads with orifices for resins with the usual colors, i.e. cyan, magenta, yellow, black and white, mainly required for graphic design. All resins are UV-curable. This allows the production of lenses and other structures in one single working step. Virtually any surface structure and design can be realized, from a smooth piano-lacquer like surface to a vivid wood imitation that looks pretty natural (Figure 5).

Optical Products

LUXeXceL does not intend to produce optical and other components itself. The company's objective is to establish

Figure 5:
Using printoptical technology opens new design options. In one working step the lens and the housing may be produced in different designs, for instance a wooden surface can be mimicked

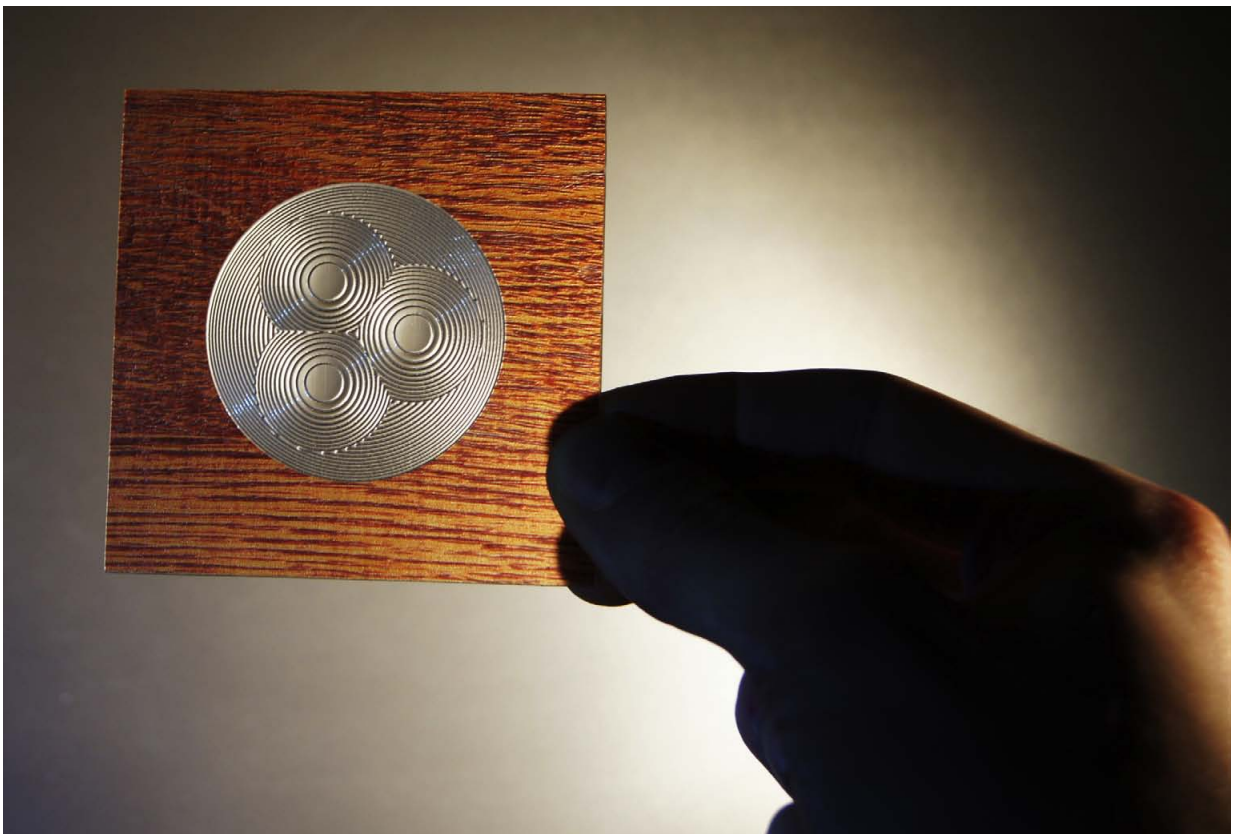
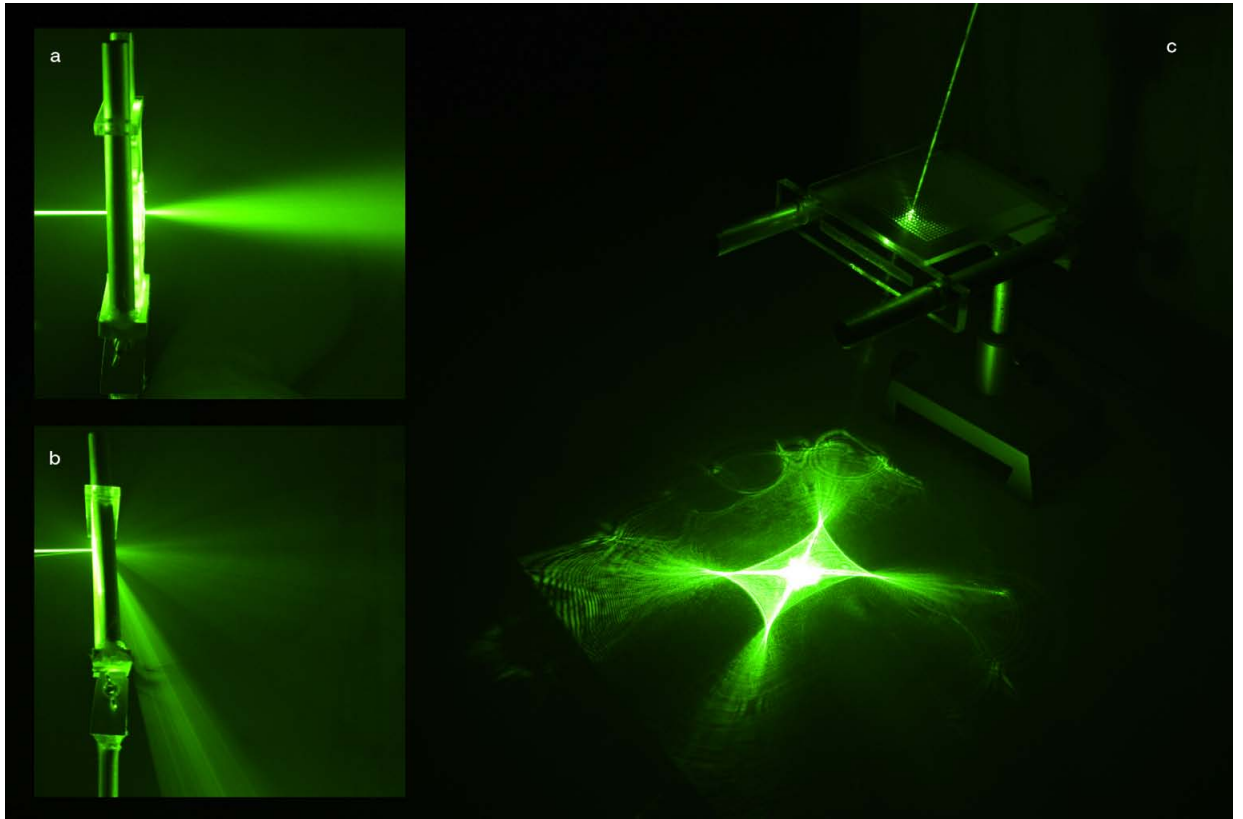

Figure 6:

Using a laser allows demonstration of the effects of print-optical technology based lenses:

- a) Spherical matte
- b) Small linear prism
- c) Micro lenses



licensing agreements with third parties to use the print-optical technology, based on acquired ample patents covering the secrets of the technological details. Nevertheless, test products have been made.

At the current stage of this technology the main focus is on non-imaging-optics. - And here especially for applications where the light needs to be blended into one smooth image (Figure 6).

Printing micro-optical structures on foils is one important application area (Figure 7). Digitally designed & printed microlenses can facilitate the creation of a variety of effects such as collimation, color-mixing, diffusion and

Figure 7:

Making high quality optical micro structure on foil is just one of the options this technology offers at a reasonable cost

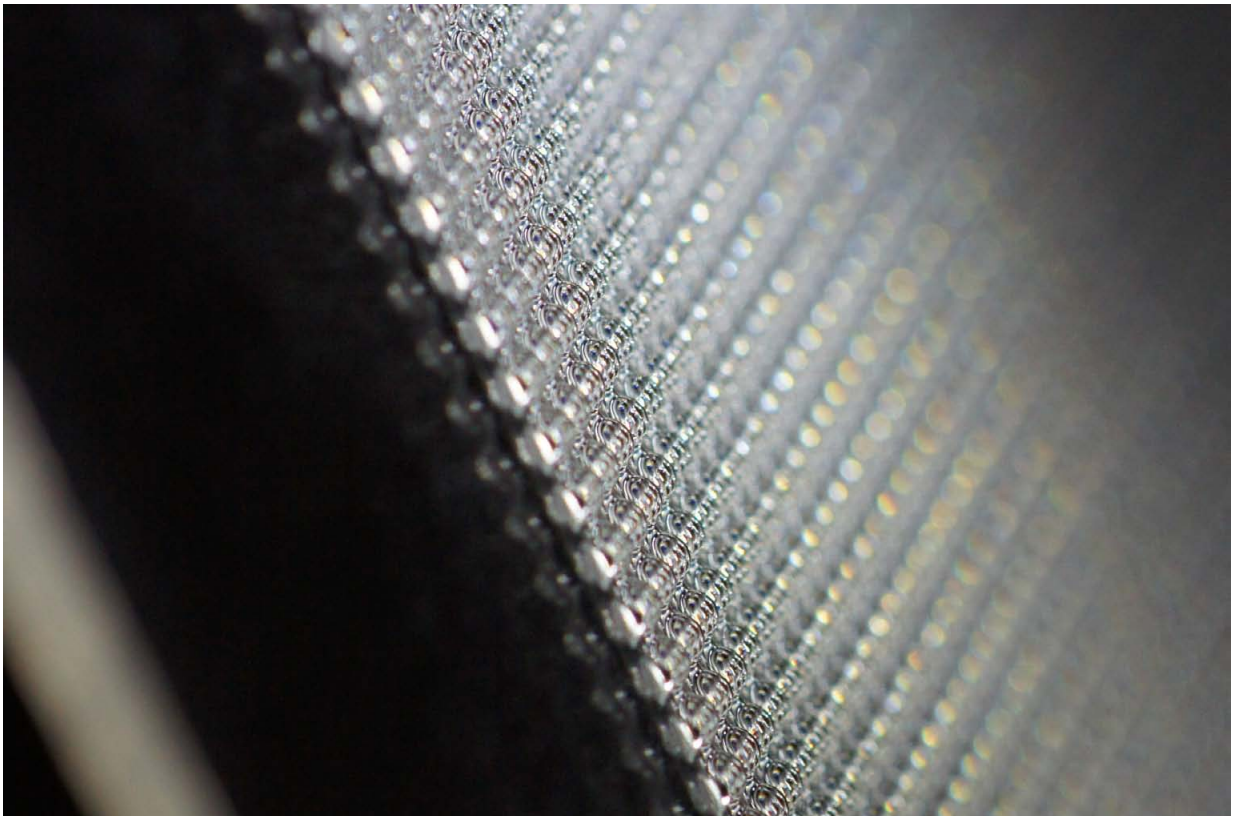

Figure 8:
Examples of discrete optical components manufactured using print-optical technology. (from left to right: an assembly from print-optical lenses, a relatively simple Fresnel structure, linear prisms, complex Fresnel structure)



diverting. Such foils can be fitted to windows to enhance daylight and light distribution in offices, for example. They can also be used to increase the output of photovoltaic cells for converting solar radiation into electrical energy. And, they can improve light distribution of LED panel lights.

What might be of even more interest is the manufacture of discrete optical components. In the case of lenses, the Fresnel type is often the preferred option, as it saves on time, material and costs because of its thinness.

Figure 8 shows more examples of Fresnel type lenses, plano-convex lenses and linear prisms.

These examples also clearly show that it is quite easy to modify prototypes optically, because only graphic design software modifications are required, as opposed to complex tool modifications in the conventional production of optics. Producing aspheric or freeform optics is relatively easy – if the geometrical CAD description is available, of course. The same applies to complex bifocal or trifocal optical components. Print-optical technology also makes optical experiments easy, because modifying components does not require much time.

Possibilities

It is very easy to let the imagination run wild and think about where else print-optical technology could be used. It is not unrealistic to think that accuracy of print-optical technology will further improve. In fact as a next step, accuracy will be improved through print-nozzle downscaling and the maximum height of an optical element will be increase clearly beyond the current value of approximately 1 mm.

Up to now, the production of multifocal glasses was a cumbersome affair of grinding and polishing (Figure 9), and this may be a fruitful area of application. In theory, providing the geometrics of such glasses in digital form would be sufficient to build them from transparent dots in print-optical technology.

Further Perspectives of this Technology

When thinking about the future of print-optical technology, other deposition techniques could be imagined than the one described with UV-curable polymer. When heating a print-head, it might be possible to spray dots of molten plastic. Such dots would harden when deposited on the

relatively cold substrate. Such a technique could also be applied to deposit electrically conductive plastics on the substrate for manufacturing conductors in electrical circuits. Spraying doped plastic might also make it possible to integrate active components such as OLEDs and optical switches.

Another conceivable technique would be to use two print-heads, each of which sprays a composing liquid for a two-component resin, e.g. the hardening agent and basic resin for making polyester. After being deposited, the two differently composed dots would react together to form a thermoset or thermoplastic.

A further conceivable idea would be to combine print-optical technology with, for instance, surface mounting technology in hybrid circuitry. Then, active elements like LEDs and optical switches could be mounted on a substrate that already has optical elements thanks to print-optical technology.

As a result, relatively cheap photonic integrated circuits could be made. And going even further, you could imagine optical displays based on print-optical technology with surface-mounted or directly deposited transistors and LEDs.

Figure 9:
For some applications, print-optical technology may help to avoid complicated and costly processes used today like polishing and grinding multifocal glass

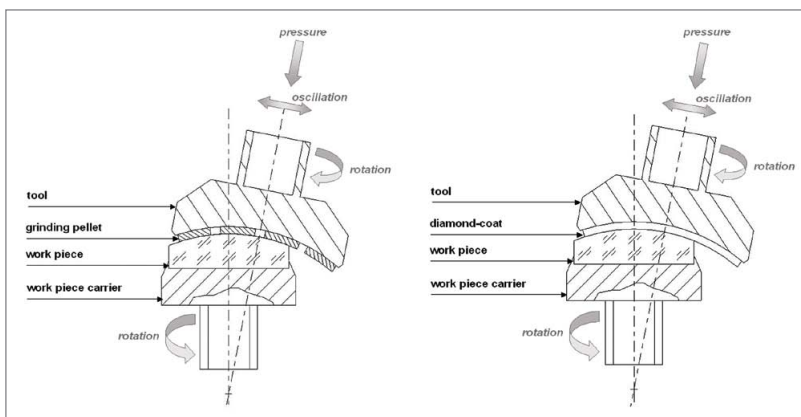

In the near future, creative minds will most definitely understand the advantages of print-optical technology for straightforward optical component production. ■



TAIWAN INT'L LIGHTING SHOW



Exhibits Profile

- Household Lighting
- Commercial Lighting
- Industrial Lighting
- Office Lighting
- Outdoor Lighting
- LED Technology
- Lighting Accessories, Parts & Components
- Light Control, Management and Measurement Systems
- Light Production and Measurement Equipment
- Test & Inspection Equipment

**Next year, TILS shines even brighter as it hosts
the GLF & CIE-Taiwan annual meetings!**

MAR. 13-16
2012

Taipei World Trade Center Exhibition Hall 1

www.TILS.com.tw



Sponsor:
Bureau of Foreign Trade, MOEA



Organizers:
TAITRA
www.taipeitradeshows.com.tw



TLFEA
www.lighting.org.tw

Effective LED Replacement Bulb Cooling by Passive Convection

LED replacement bulbs with high lumen output above 1000 lm are badly needed but technical constraints, namely thermal management issues, make it hard to design products having the desired form factor while meeting lifetime and efficiency requirements. David Horn, CTO, and Ronan Le Toquin, Technology Director at Switch Lighting discuss a new and promising approach applied in their products.

The need for cost effective, energy efficient, high output lamps of 75 W output, 1100 lumens and above is now greater than ever. With the phase out of incandescent lamps from general lighting started with Brazil, Venezuela, Switzerland, Australia and the European Union, the United States will start phasing out 100 W incandescent lamps in January of 2012, with the 40 W lamp phase out planned for 2014. The phase out has not generally been met with enthusiasm by consumer groups, due to the poor light quality of alternative technologies and environmental concern over the proliferation of compact fluorescent lamps (CFL) and the potential for mercury pollution and contamination. LED lamps are an excellent choice, but lamp performance at 75 W, 1100 lm and above have not generally been available.

Difficulties to Overcome

Lamp designs are constrained by two major challenges: LED efficacy, the lumens produced per watt of electricity, and the lamp's ability to remove heat generated in the lamp. High brightness white LEDs have made incredible performance improvements over the past decade.

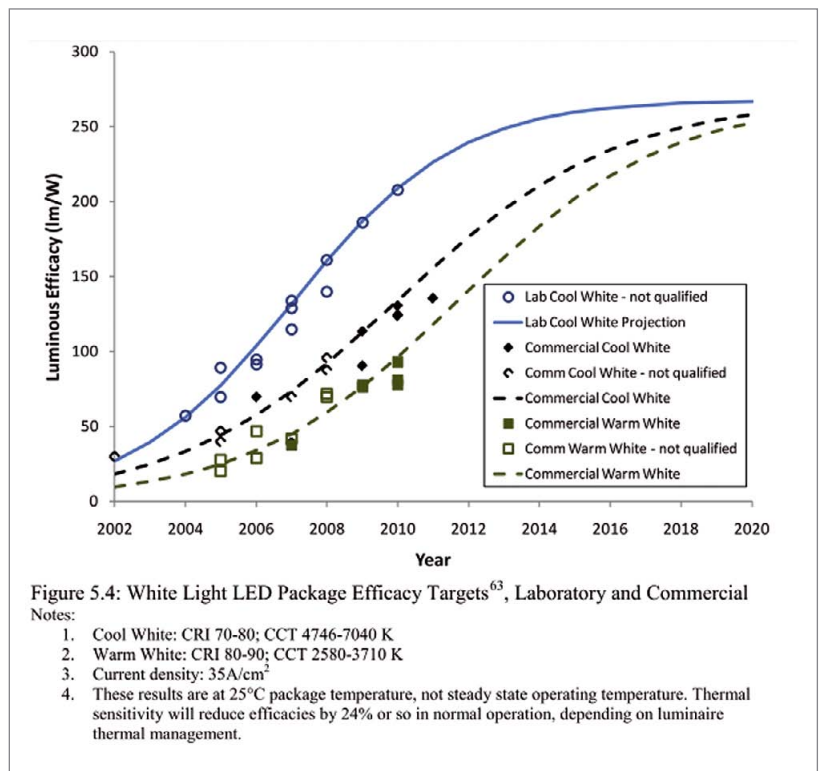

Figure 1: DOE White Light Efficacy Targets for 2011 Plan

One common misconception is that LED efficacy will continue to improve at the same rate over the next decade. A better estimate of the predicted performance of LED efficacy can be seen from the U.S. Department of Energy's performance goals, stated in the 2011 Multi-Year Program Plan for Solid-State Lighting Research and Development [1].

The chart shows that LED efficacy increases will be slowing year over year, reaching their asymptotic limit just after 2020. This year, 60 W warm white lamps will be achievable by several lamp manufacturers. With the slowing of improvements in LED efficacy, the ability of companies to launch white light LED-packaged lamps at 75 W, 100 W and above will

Figure 2:
Effect of dry
versus fluid
cooling of LEDs in
this lamp concept

be increasingly challenging, if not impossible, for many of the current lamp architectures. The ability to cool the LEDs will play an increasingly central role in lamp performance.

Another common misconception is that LEDs produce no heat and, therefore, LED lamps should operate cool. In fact, high brightness LEDs used in today's highest performing lamps are rated to produce greater than 70% of their initial lumen output, L70 after 25,000 hrs operation at temperatures above 100°C. The estimated efficacy improvements projected by the DOE are at 25°C. The degradation in efficacy due to operating at actual lamp steady state temperatures is explained in note 4 of Figure 1, "Thermal sensitivity will reduce efficacies by 24% or so in normal operation depending on luminaire thermal management." This note indicates that if warm white LEDs reach their asymptotic efficacy of 250 lm/W at 25°C in 2020, that in actual applications the maximum performance of this LED in steady state elevated temperatures can be de-rated to approximately 200 lm/W, maybe even more.

While it is much more energy efficient than an incandescent lamp, much of the power into an LED lamp is lost in the form of heat. In a typical white phosphor LED lamp, the surface area of the metal heat sink provides the primary path for convective heat flow from the lamp. LED lamp manufacturers must balance the needed surface area of metal heat sink to keep the driver and LEDs cool enough to achieve the lamp's lifetime against the amount of glass surface area needed to distribute the light uniformly. Due to these thermal constraints, most LED lamps are limited to an input power of between 8 and 13 watts.

With all of the challenges of providing higher watt-equivalent LED lamps, manufacturers have been limited to producing low watt-equivalent lamps, from 40 to 60 W and between 450 and 800 lm, respectively. Using fans to move air across the heat sink is one

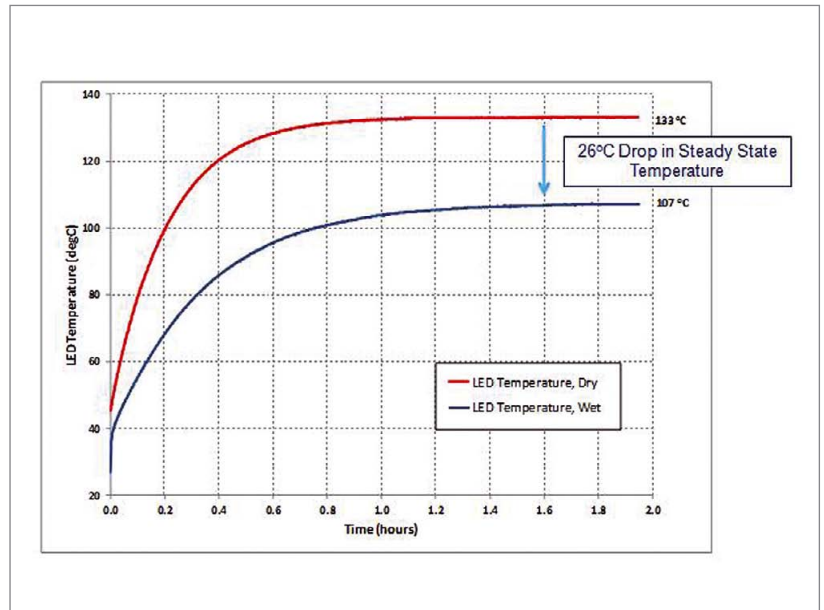

popular method of overcoming the thermal constraints of the metal heat sink. This type of design carries more heat away, but at a cost. Fans take energy, which lowers the efficacy and energy efficiency of the lamp. In addition, fans need to operate above a certain rpm, which generate noise and lowers the lifetime of the moving parts, especially at high operating temperatures. Also, using fans means that noise is often present and at the operational temperatures of the lamp reliability of the moving part must be overcome. Lamps that depend on standard LEDs and heat dissipation by metal heat sinks alone constrain the positioning and density of the LEDs and usually provide light that is highly directional, like a flashlight. Using one of these LED lamps in a typical residential luminaire application would provide poor light distribution.

A New Thermal Solution

Thermal cooling is the limiter for LED lamp performance. The key is to adapting technology for a consumer LED lamp that looks attractive in its form factor, brightness, light distribution and color quality. In order to achieve these goals, a unique thermal cooling design in the lamp has been employed. The non-toxic fluid moves passively, without fans or pumps in a convection pattern. The energized LEDs exchange heat with

the fluid, which expands and is buoyed up to the transparent shell of the lamp where it cools, becoming more dense as it drops in the lamp, and is again pulled towards the fluid near the LEDs and moves up. The lamp is engineered so that this convection flow is optimized to cool the LEDs when the lamp is in any orientation. The fluid cooling effect can be seen in Figure 2 which shows the LED temperatures in such a bulb with and without fluid. In this example, a 26°C drop in LED temperature is realized.

The new thermal solution efficiently cools the LEDs, however, the typical LED lamp currently on the market has several shortcomings. The lifetime of an LED is generally controlled by the temperature it is operated at and the drive current or power into the LEDs in the lamp, illustrated in Figure 3 from Philips Lumileds Rebel Reliability Datasheet RD07. The graph plots the lifetime in hours on the vertical axis against the pad or case temperature of the LED on the horizontal axis. The plotted green, red and blue lines show the projected lifetimes at temperature for 1 A, 700 mA and 350 mA operation respectively. Note that this graph represents a case where the test samples of LEDs are taken to their L70 point, 70% of initial light output and the number of LED failures is B10 of 10% or less.

Figure 3:
Operating conditions versus expected (B10, L70) lifetimes for InGaN LUXEON Rebel and initial condition of running the LEDs in air at position 1 and two design alternatives achieved through passive fluid cooling at operating points 2 and 3

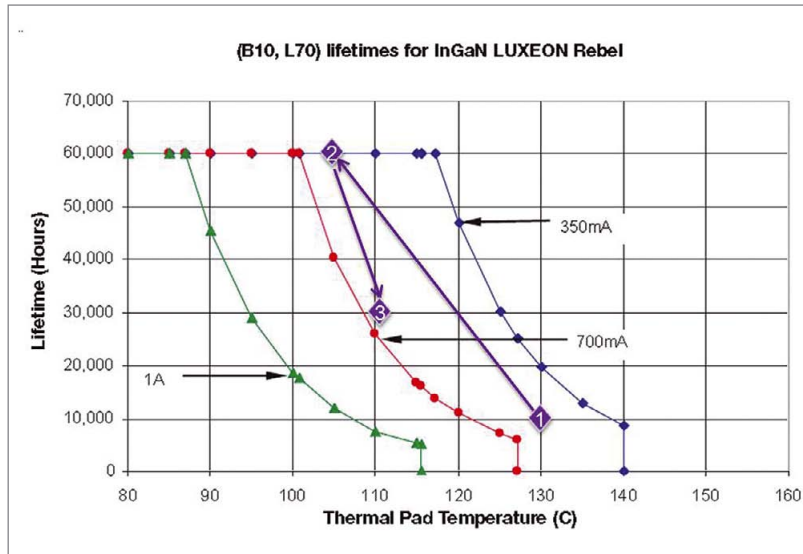

Figure 3 presents the initial condition of running the LEDs in air at position 1 and two design alternatives achieved through passive fluid cooling at operating points 2 and 3:

- At operating point 1 the LEDs are operated in air at 500 mA reaching a temperature of 133°C. The expected L70 lifetime at this operating condition is about 10,000 hrs. Operating the same bulb with fluid cools the LED's by 26°C to an operating temperature of 107°C, position 2. It can remain operating at 500 mA, producing 13% more light due to LEDs operating more efficiently at the lower temperature and the elimination of index of refraction losses, with the result that the LED L70 lifetime is now at 60,000 hrs rather than the 10,000 hrs, where it was before cooling. This option can be used in applications where the lamps will be on 24/7 and may be located where it is difficult to replace the lamp every thousand hours, as you would with an incandescent. In 24/7 operation, this is the equivalent of nearly 7 years of use. In a household application, a typical light is on an average of three hours per day, which would be the equivalent of about fifty-five years. However, all calculations are for the LEDs themselves, not for an actual lamp. The lamp lifetime is calculated based on the reliability of its components.

In comparing the lifetime of a compact florescent lamp, or CFL, to an incandescent, a CFL commonly has an 8,000 to 10,000 hours lifetime, as stated by manufacturers. The problem is that these ratings are for continuous operation. The lifetime of a CFL can be dramatically reduced when turned off and on. Unfortunately, testing standards do not completely address the way a residential lamp or many commercial lamps are used today. It is common to see energy and cost efficiency calculated based on these numbers, but in many cases, the consumer will never realize these savings.

- Increasing the drive current or power to the LED from 500 mA to 600 mA, produces more light and brings the L70 to 30,000 hour lifetime. As the drive current increases, the LED pad temperature will also increase. In the example above, the pad temperature is 112°C at 600 mA, operating point 3. This 20% increase in the drive current coupled with the efficiency gain of the LEDs and reduction of index of refraction losses will produce a >30% brighter LED lamp at steady state operation temperatures, with an exceptional LED lifetime. A 30,000 hour lifetime under typical 3 hr/day household use is the equivalent of over 27 years of operation.

Orientation Tolerant Design

To produce a lamp that can be mounted in any orientation, while maintaining exceptional brightness without compromising LED lifetime, the LEDs need to be mounted in a way that maintains their operating temperature in any orientation. A fluid-guiding structure has been developed which, when the LEDs are heated during normal operation, allows the fluid to cool the LEDs within +10C in all orientations. Schematics of the fluid flow during operation are shown below in Figure 4. These lamps are cooled so efficiently and maintain a stable temperature across the LEDs because the cooling of the LEDs is not limited to thermal conduction through the heat sink like typical air lamps, but with the addition of convective cooling the LEDs can be lifted into the center of the lamp shell. Therefore, unlike competitive products which restrict the lamp operating environment, these bulbs can be used in any orientation without impacting the product's performance and lifetime. Notice that the positioning of the LEDs will also help efficiently distribute light from the center of the globe, mimicking an incandescent.

Improved Optical Efficiency

Air-filled LED lamps suffer from optical losses as the light emerges from the LED into air, then into the transparent shell or dome and back into the air. By Snell's Law, we know that as light passes between these various materials, optical losses occur at each interface relative to the change in the index of refraction of the materials. In an air lamp, these losses can add up to between 8-9% at normal incidence based on the three primary materials' interfaces: LED to air, air to shell material, and shell material to air. In this lamp, the fluid is nearly index matched to the LED and shell or globe material, thereby eliminating almost all of the optical losses at two of the interfaces: LED to air and air to shell material. The only major optical interface left is the shell to air interface at about 3%. This 5% improvement in optical efficiency adds to the fluid lamps' overall energy efficiency.

Figure 4:
Fluid Flow
at various
orientations

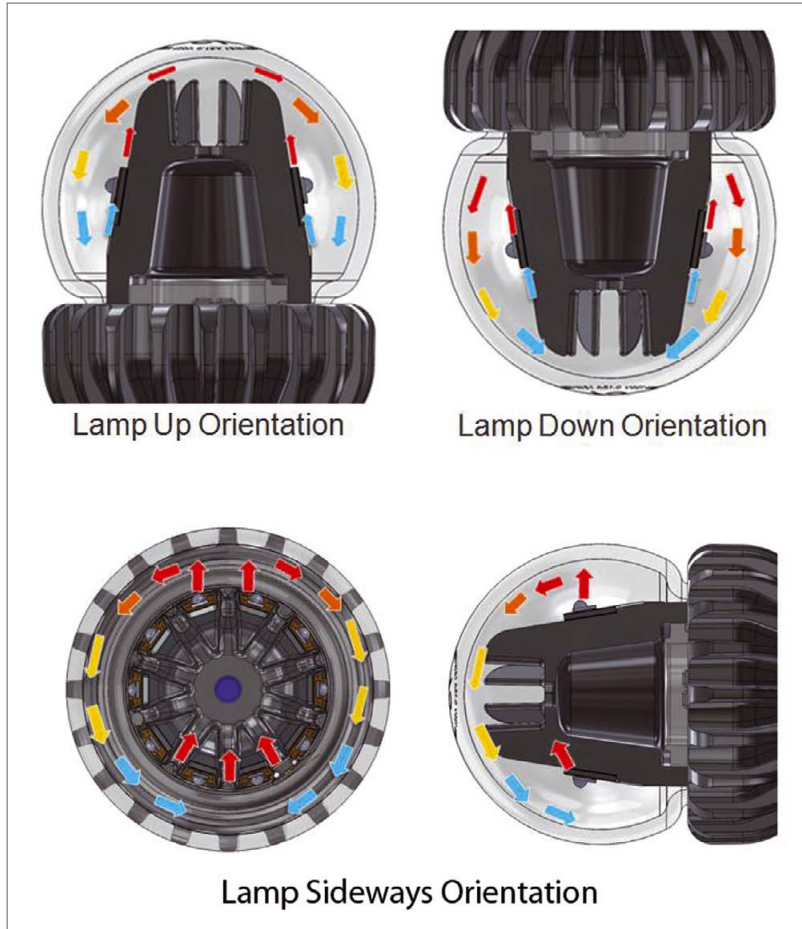

Greater Light Distribution

In a typical LED lamp, the LED is mounted to a conductive heat sink that distributes the heat to air interface where it can radiate the heat and be cooled by the convection properties of the air. Usually, the conduction path from the LEDs to the air interface is kept as short as possible, to provide as much cooling to the LEDs as possible. For this reason, the LEDs are mounted on a flat plane on top of the heat sink. Light from LEDs is emitted in a Lambertian radiation pattern. Like a flashlight, the majority of the light shines in the direction you point the LED, with virtually no light at 90 degrees from the LED direction.

An incandescent lamp throws roughly 50% of the light up and 50% down. LED lamps with an air-filled dome throw a majority of light up and very little light down. In a table luminaire, the effect would be similar to a spotlight shining out the top of the luminaire with the table poorly illuminated. With increasing diffusion or scattering, this distribution of light can be improved, but the light is reflected or scattered, the more optical losses that will incur. Many lamps on the market redirect the light from a Lambertian distribution to improve the light distribution, resulting in optical losses of over 15%. As discussed earlier, the LEDs have been moved to the center of the glass shell, to properly cool the LEDs in all orientations and efficiently distribute the light, which provides a more uniform illumination in all directions. The result is a light distribution that closely mimics that of an incandescent.

Figure 5:
Comparison of
Optical Losses

- Switch LEDs in fluid dome optical losses ~ 3%
 - LED to fluid interface, ~.1%
 - Fluid to dome interface, ~.1%
 - Dome to air interface, ~3%
- LED in air dome optical losses ~ 8-9%
 - LED to air interface, ~3%
 - Air to dome interface, ~3%
 - Dome to air interface, ~3%

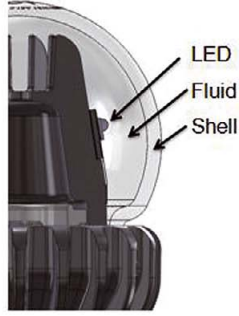

Figure 6:
Comparison of
Light Distribution

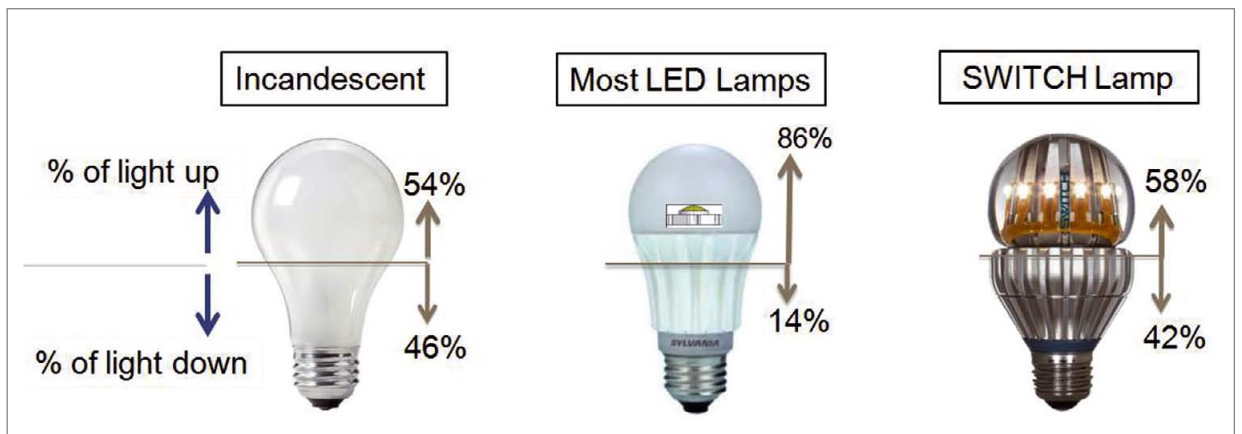

Figure 7:
The 1150 lm Switch75 LED lamp will be available Q1 2012. Later in 2012 the Switch100 will provide 1700 lumens in natural white



Additional Benefits

These bulbs are engineered to provide a convenient and workable energy efficient lighting alternative to incandescent and compact fluorescents lamps (CFLs). Incandescent lamps generate wasted heat, using only 20% of their power to create light with the remaining 80% of the input power dispersing as heat. This can often require additional energy in the environments where they are used in the form of fans or air conditioning to reduce the heat. CFLs, although deemed to be energy-efficient, have a greatly reduced lifetime if the lamps are turned on for short periods of time and then turned off, which is how the majority of consumers use them. CFLs also present the problem of toxic mercury within the bulbs, which requires special handling if the lamps are broken and careful disposal to avoid polluting the environment.

In contrast to an incandescent, Switch's unique fluid-cooled LED lamp uses only the input watts of power needed to create the light. That is, they use 85% less energy than incandescent lamps. In comparison to a CFL, the lamp is not only free of toxic mercury, but also meets or exceeds the energy efficiency of CFLs, has a lifetime of 25,000 hours, and is engineered to withstand on/off cycles of normal consumer use.

Beyond these advantages, the applied design process is inspired by Cradle to Cradle® principles, which focus on using safe materials in the product design that can be disassembled, recycled and reclaimed for rebirth as nutrients or materials usable in the production of new lamps or other products. The materials and manufacturing practices of the lamps are assessed in five categories:

Material Health, Material Reutilization, Renewable Energy Use, Water Stewardship, and Social Responsibility. The lamps' environmental assessment not only considers from the benefits of the products, but is also inclusive of aspects, such as the manufacturing of raw materials, packaging materials utilized, and product transportation.

Conclusions

This unique technology and inventive design combine to make these lamps outshine all others. The lamps fit into existing standard sockets and can be used most anywhere standard incandescent lamps can. The lamps are designed to be used in any orientation – up, down, or sideways – for uniform light anywhere. The lamp is also instant-on and dimmable – just like the standard incandescent. ■

References:

[1] http://apps1.eere.energy.gov/buildings/publications/pdfs/ssl/ssl_mypp2011_web.pdf

the arc show

LONDON

EXPERIENCE LIGHT...

Architectural, Retail & Commercial Lighting

Business Design Centre, London
29 February – 1 March 2012
www.thearcshow.com

A unique event for the European lighting industry to source for global lighting projects; from public and local authority, through to the creation of world leading retail environments.

The ARC Show hosts the newest and most innovative lighting technologies, developments and designs.

This international meeting of minds also welcomes the **IALD Enlighten Europe Conference** alongside complimentary seminars from leading industry associations.

Register for FREE entry now at:
www.thearcshow.com

Scan QR code for the latest show information.

(To download a QR code reader to your mobile phone please visit <http://www.mobile-barcodes.com/> qr-code-software)



Organised by:

In association with:



mondo®

IALD

bd

Property
Week
print.online.events

Building

Imprint

LED professional Review (LpR)
ISSN 1993-890X

Publisher

Luger Research e.U.

Institute for Innovation & Technology
dep. LED professional
Moosmahdstrasse 30
A 6850 Dornbirn, Austria / Europe

phone +43 5572 394 489
fax +43 5572 394 489 90
editors@led-professional.com
www.led-professional.com

Publishing Editors

Siegfried Luger
Arno Grabher-Meyer

phone +43 5572 394 489
phone +43 5572 394 489-18
editors@led-professional.com

Int. Account Manager

Theresa Koenig

phone +43 5572 394 489-20
theresa.koenig@led-professional.com

Front-page picture

Image: Arno Grabher-Meyer, LED professional, Seoul Semiconductor Z7-F
Artwork: Thomas Klobassa, ©LED professional 2011

Copyrights – Luger Research e.U.

The editors make every reasonable effort to verify the information published, but Luger Research e.U. assumes no responsibility for the validity of any manufacturers, non profit organisations or individuals claims or statements. Luger Research e.U. does not assume and hereby disclaims any liability to any person for any loss or damage caused by errors or omissions in the material contained herein, regardless of whether such errors result from negligence, accident or any other cause whatsoever. You may not copy, reproduce, republish, download, post, broadcast, transmit, make available to the public, or otherwise use LED professional Review (LpR) content without prior written consent from Luger Research e.U. – Institute for Innovation & Technology, Austria. ■



LED professional Review (LpR) - Annual Subscriptions

LpR Digital Magazine

- 6 issues
- pdf download
- high resolution pictures and graphs
- printable
- commercial use
- access to all previous issues
- Euro 78.80

<http://www.led-professional.com/subscription>

LpR Printed Magazine

- 6 issues
- Euro 158.40

Next LpR Issue - Jan/Feb 2012
Drivers and System Integration

LED SYMPOSIUM
professional | +EXPO
LpS 2012



LED Lighting Technologies
International Winning Approaches

25-27 SEPTEMBER 2012
BREGENZ | AUSTRIA

CALL FOR PAPERS
www.lps2012.com

CONTACT:

LUGER RESEARCH | Moosmahdstrasse 30 | 6850 Dornbirn
T +43 5572 39 44 89 | F +43 5572 39 44 89 90
info@lps2012.com | www.lps2012.com

e:lumix
Technologie AG

OSRAM
Opto Semiconductors

TRIDONIC
▼ engineering your ideas

Your partner for lighting components,
lighting management systems and LED modules

TRIDONIC

▼ enlightening your ideas

We can do a lot for your light.

Impressive solutions for your LED products.

The LED Solution Box from Tridonic is a versatile package that includes the light source and helps you find the solution you want – components, light modules, systems and renowned Tridonic service. With Tridonic, you have everything under control, whether you choose conventional or LED lighting. **We devote all our energy to your light.**
led.tridonic.com



WHO WANTS TO SWITCH OFF
NUCLEAR POWER HAS TO SWITCH
ON INTELLIGENCE.



More and more nuclear power plants are being shut down. So we need to save energy now. One of the easiest and most effective options is to change from the usual means of illumination to LEDs. LED technology can provide suitable replacements for everyone. LEDs are more durable, dimmable, and they provide directional light. Seoul Semiconductor is a global company that ranks among the top four in the worldwide LED market and holds more than 6,000 patents.

Better Be Bright.
www.betterbebright.com

