

**LED**  
professional

[www.led-professional.com](http://www.led-professional.com)

ISSN 1993-890X

# Review

LpR

*The leading worldwide authority for LED lighting technology information*

Mar/Apr 2012 | Issue

**30**



**Light+Building Preview**

**LED Modules & PCBs**

**Phosphor Green LEDs**

**Buck-Based Offline Drivers**



# LUXEON®

## Light that works

In shops and offices, in tunnels and on roadways, LUXEON works. With unparalleled efficiency, quality of light and reliability, the LUXEON portfolio simplifies your solutions and shortens your development time.

Learn more about how the LUXEON portfolio can help you, visit our website.

[www.philipslumileds.com](http://www.philipslumileds.com)



**PHILIPS**  
**LUMILEDS**



## Application in Focus

An assessment of the life-cycle environmental and resource costs in the manufacturing, transport, use, and disposal of LED lighting products in relation to comparable traditional lighting technologies was performed by the U.S. Department of Energy (DOE) and recently published.

Nowadays, LED lamps and CFLs use about one quarter of the incandescent lamp energy consumption when compared to a life-time of approximately 25,000 hours (20 million lumen-hours).

The comparison was made based on a 60W incandescent lamp. It was also found that the “use” phase of incandescent, compact fluorescent and LED lamps represents the most energy intensive life-cycle phase, accounting for 90 percent of total life-cycle energy on average. This is followed by the manufacturing and transport phases.

By 2015, if LED lamps meet their performance targets their life-cycle energy use is expected to decrease by roughly one half. From then on, LEDs will surpass all light sources in terms of energy consumption.

In contrast to pure energy considerations, which are, of course, important to all of us, there are some hurdles to overcome when thinking about an LED technology breakthrough. Problems occur in terms of usability, applicability and system design. Luminary and module engineers will need “design-packages” where it is easy to apply the technology. The trend toward standardized modules, resulting from, for example, the Zhaga initiative, is one of the most important corner-stones. The Light + Building Preview show in Munich, which took place in February, clearly confirmed this trend. In addition, it highlighted increased lumen-packages per volume, adaptive systems such as color temperature shifts during dimming and LED luminaires with simplified installation processes.

We are about to cross over from “functional components” to application dedicated and need-oriented LED lighting systems. Light + Building expects more than 2,100 exhibitors and 180,000 visitors in Frankfurt this year, making it the world’s largest lighting show. We are going to check out all the latest news, innovations and trends in Frankfurt and find out how they will meet the trends of future lighting.

Feel free to contact us if you’d like to talk to us personally while we’re there!

Yours Sincerely,

A handwritten signature in blue ink, appearing to read 'S. Luger'. The signature is stylized and fluid, with a long horizontal stroke extending to the right.

Siegfried Luger  
Publisher

**PS:** 2nd Annual LED professional Symposium & Exhibition – LpS 2012

- Program Available
- Early Bird Registration Open Now

[www.LpS2012.com](http://www.LpS2012.com)

# Content

■	Editorial	p 1	COMMENTARY	p 4
	Imprint	p 60	News - PROJECTS	p 5
			News - PRODUCTS	p 6
			News - RESEARCH	p 24

---

■	<b>EVENT</b>			
	Light+Building Highlights – Exhibits Focus on Energy Efficiency and Versatility	p 26		
	by Siegfried Luger & Arno Grabher-Meyer, LED professional			

---

■	<b>INTERVIEW</b>			
	LED Technology – Changing the Component Business in the Area of Lighting	p 34		
	Interview with Volker Neu, Vossloh-Schwabe Optoelectronic			
	by Siegfried Luger & Arno Grabher-Meyer, LED professional			

---

■	<b>APPLICATION</b>			
	New Approach for a Modular LED COB System up to 500 W	p 38		
	by Magnus Ahlstedt & Johann Ramchen, Optogan			
	PCB Design for a High End Stage Light	p 42		
	Stefan Hoerth, Haeusermann			

---

■	<b>TECHNOLOGY</b>			
	Closing the Green Gap: A Long-Pass Dichroic Filter-Capped PC-LED	p 46		
	by Young Rag Do, Department of Chemistry, Kookmin University			

---

■	<b>ELECTRONICS</b>			
	Energy Efficiency of Buck-Based Offline LED Drivers	p 52		
	by Mikka Maaspuro, Pauli Auramaa & Aulis Tuominen, Univ. of Turku			

## Advertising Index

Philips Lumileds	C2
Recom	p 3
Cree	p 7
Arrow Electronics	p 11
EKL	p 13
Dilitronics	p 13
Everlight	p 15
Farnell	p 17
StellarNet	p 18
LEDLink	p 19
ARClight	p 20
Instrument Systems	p 23
Seoul Semiconductor	p 25
Global Lighting Technologies	p 27
Sharp	p 29
Regent Lighting	p 31
Prolight Opto Technology Corp.	p 33
Protect-R-Shield	p 33
Vossloh-Schwabe	p 35
Micrel	p 37
Green Lighting Shanghai	p 40
Edison	p 41
Osram	p 47
Signcomplex	p 50
Guangzhou Int. Lighting Exhibition	p 51
Signcomplex	p 53
Lightfair International	p 57
euroLED	p 59
Tridonic	C3
LED professional Symposium	C4

# LED Drivers

Buck/Boost LED Drivers - From 1W to 60W.

5 Year Warranty

Highest Efficiency

Dimming down to 0%

TRIAC Dimming

AC or DC Input



Visit us:



15.-20.04.2012, Frankfurt  
RECOM booth: G21, Hall 4.0  
OSRAM booth: D50, Hall 4.1

For Application Support contact your  
local RECOM sales contact or go to:  
[www.recom-electronic.com](http://www.recom-electronic.com)





### Christian Hochfilzer

Christian Hochfilzer works at Regent Lighting, the Swiss market leader for professional luminaires as a Technical Director and Member of the Management Board.

He holds a doctoral degree in solid state physics from the Technical University Graz, Austria. He has also worked in different management positions at Tridonic.

Prior to that he was active in a start-up company focussing on solid state lighting and optoelectronic systems.

## SOLID STATE LUMINAIRES PAVE THE WAY FOR AN INDUSTRY

From metal sheet forming to optoelectronic systems

Luminaire manufacturing began soon after the production release of incandescent bulbs and since then has been linked to the peculiarities of the used light source. Over a time span of almost 150 years, luminaires have also been built around other light sources like fluorescent tubes and various gas discharge lamps as well as the halogen lamp. These light sources commonly use a glass body with appropriate electrical contacts that fit into standardized sockets. Via standardized ballasts and normed terminals and cables the light source is connected to the electrical grid. It took decades to establish this multi-billion Euro industry with well structured worldwide standards and value chains. And now, within a period of less than ten years, this industry has been shaken to the core and, in fact, this process is ongoing.

A major impact is the emergence of solid state light sources with current ground-breaking luminous efficiency and features that meet customer expectations. Today we have perfect conditions to apply solid state light sources in all application segments of professional lighting.

Beyond that, there are other criteria that have an impact on the luminaire business. Consider that approximately 19% of the electricity worldwide is used for artificial lighting. For years we have been seeing an ongoing quest for controls and ballasts that help to save energy with traditional light sources. Now, for the first time, the integration of semiconductor based emitters in combination with complex electronic circuits containing sensors and (micro-) controllers pave the way for the development of highly efficient "digital" light sources.

The industry again faces the challenge of building a luminaire around this new light source. But for the first time there are tighter lacing bonds between the luminaire and the light source like the thermal path to dissipate thermal losses to name just one. As a consequence, mechanical engineers have to learn electronics, optical engineers have to study semiconductor assembly and standardization is not as easy as it was in the past.

These technical hurdles are overlapped by a transformation in the supply chain and the speed of technology enhancement which is all new to the industry. This is definitely a big challenge but it is also an opportunity.

Luminaire manufacturers have to deal with optoelectronic systems and have to adapt their processes accordingly.

The new features of this digital light source have to be understood and the technology push has to be translated into innovations the customer is interested in. One example is the possibility of changing the emission color next to the brightness. This is not new, but nowadays, easy to integrate.

There is some truth in the words of T.S.Eliot: "We shall not cease from exploration. And the end of all our exploring will be to arrive where we started and know the place for the first time." Artificial light will be needed in the future more than ever and luminaire manufacturers will be there providing their service.

C.H.

## MEGAMAN® Lights Up New Designer Fashion Complex in Hong Kong

An exciting new shopping experience in the heart of Hong Kong's financial and commercial district, Central, is turning heads thanks to its array of designer stores, lit with the latest in highly energy efficient MEGAMAN® lamp technology.

While the design of each of the stores aims to offer the maximum flexibility for merchandising, the lighting technology used throughout has been chosen with visual impact, customer comfort and energy efficiency in mind. Tino Kwan chose to use MEGAMAN® LED Reflector Technology due to the lighting performance of the lamps, the variety of directional beam angles available and the sustainable credentials of MEGAMAN® as a company. Over 750 MEGAMAN®'s LED AR111 10 W dimmable 8, 24 and 45 degree light sources and MEGAMAN® LED MR16 10 W dimmable 24 degree lamps were used, to create the right balance of drama and ambience within each of the stores, whilst reducing heat and energy consumption.

### The possibilities of LED technology:

Apart from its energy saving potential and light quality, LED technology is of interest in retail installations due to the reduced heat output of the lamps and their ability to be positioned near items on display.

Part of MEGAMAN®'s LED Reflector Series, MEGAMAN®'s AR111 and MR16 ranges of LED low energy replacements for halogen reflectors incorporate the company's patented Thermal Conductive Highway™ (TCH) technology, which has superb heat dissipation, lighting performance and lumen maintenance. As a result the MEGAMAN® LED AR111 and MR16 ranges last up to 13 times longer and use 80% less power than halogen equivalents. With the same high quality light intensity and color rendering of traditional AR111 and MR16 spotlights (color rendering of up to Ra92), but with no UV light radiation, negligible IR radiation or residual glare, the LED AR111 and MR16 ranges are ideal for use in any retail outlet.

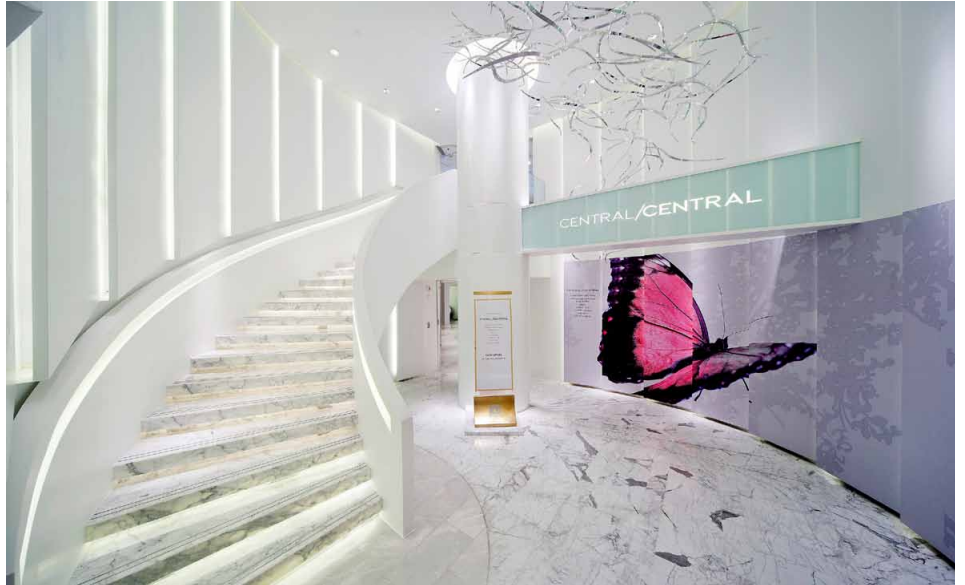

The entrances and stairways are impressively illuminated

### Central/Central – the design experience:

Designed as a lifestyle experience, Central/Central encourages customers to find inspiration, balance and a sense of wellbeing in its stores and VIP suite. From the moment shoppers arrive at the double-height atrium Central/Central seeks to inspire and welcome.

### The Atrium

To evoke a sense of floating within an ethereal setting, textures rather than colors are used within the atrium, to add interest and depth.

### The Stores

The curved, sculptural walls lead customers to the Nine West store, illuminated by signature light cubes in the windows. An off-white palette, light oak wood flooring and warm lighting serve to highlight the colorful seasonal merchandise; while diagonal shelving provides a layered, 3-D perspective.

### The VIP Suite

The VIP suite includes a curved wall and curve-line sofa to maintain the interior's sense of flow and harmony throughout this private sanctuary. Because of the long lamp-life and superior light performance of MEGAMAN®'s LEDs, Central/Central will not only look good for many years to come but save significant amounts of energy and CO<sub>2</sub> in the process.

Thanks to the use of MEGAMAN® LED reflector technology, the end result is not only the ultimate in visual lighting drama, but in energy savings as well with 105,090 kWh saved in energy consumption and 73,563 kg in CO<sub>2</sub> emissions per year. ■



The Carolinna Espinosa boutique is just one example for LED shop lighting powered by Megaman®



The Joan & David boutique entrance, another great example for the lighting capabilities of LED lights



The Karen Millen storefront, perfectly set to stage with Megaman's LED lamps

## Verticle Starts Mass Production of the World First Hexagonal LED Chip

Verticle, Inc. announces the mass production of hexagonal-shaped LED chip Honeycomb™, a revolutionary LED chip developed with Verticle's patented Cu substrate and chemical chip separation technology for optimized light extraction efficiency. This vertically structured LED chip features significant benefits that include higher light extraction and more uniform beam profile than conventional square or rectangular LED chips based on sapphire or silicon substrate, said Dr. Mike (M.C.) Yoo, Verticle's CEO.

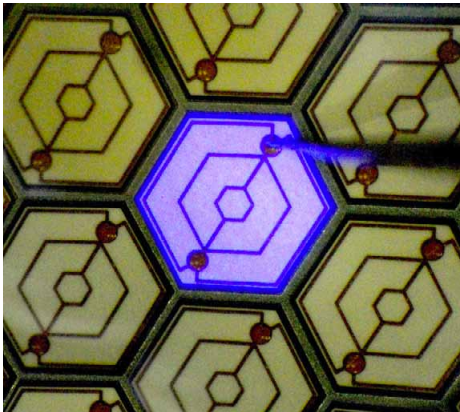

**Verticle's Honeycomb™ hexagonal structure promises advantages in light distribution for packaged optical systems**

Although there have been many attempts to fabricate various shapes of LED chips with conventional laser scribing or dicing, only a few shapes, like diamond or triangle-shaped LED chips, were possible to be fabricated at the R&D level, NOT in the production level. Chemical chip separation technology invented by Verticle Inc. makes the chip separation step much easier and quicker than conventional chip separation techniques, making it easier to fabricate any shape of chip, even circular.

In addition, Honeycomb™ delivers the improvement in performance of the diode, compared to square or rectangular type LEDs. Since the optical efficiency of the LED chip depends on the effective current density in the active region and hexagonal architecture allows better control of current spreading, Honeycomb™ is able to operate at high currents, hence achieve higher brightness.

A conventional square or rectangular LED chip has a distorted beam profile, when it is packaged with a typically circular lens. However, a hexagonal-shaped LED chip that is closer to circular chips generates much less distorted beam profile, hence, a very small dark spot. This allows a higher lumen than the conventional square or rectangular chip that has similar electro-optical properties after packaging with a circular lens. Honeycomb chips can also use the same flat form package as square or rectangular chips, which means there is no additional cost or system improvement required.

Furthermore, Honeycomb™, with its Cu substrate, has an excellent thermal and electrical conductivity, crucial for both long life and good thermal behavior of the diode.

According to Verticle Inc., main optical power range is between 370 - 420 mW at 350mA with a forward voltage range between 3.1 - 3.4V. ■

## SemiLEDs Announces 40% External Quantum Efficiency for Ultraviolet (UV) LED Chips

SemiLEDs Corporation, a leading developer and manufacturer of LED chips and LED components, announced that its UV LED chips are capable of emitting radiation at a wavelength of 390-420 nm with 40% external quantum efficiencies (EQE – a LED's ability to convert electrons into photons) at 350 mA (up to 500 mW output power\*, typical 3.3V forward voltage).

"Our patented structure and metal alloy substrate allow us to produce and supply to the industrial curing market UV LEDs that are capable of operating at high current with high output power density," says Dr. Chuong Tran, COO and President of SemiLEDs. "We are proud to be able to advance the UV LED technology for the curing industry and to provide cost-effective solutions to our customers thanks to our proprietary MvpLED technology."



**SemiLEDs new UV LED products are available in wavelengths ranging from 365nm-420nm and can also be used to produce phosphor converted white LEDs**

SemiLEDs UV LED products are available in wavelengths ranging from 365nm-420nm, in chip sizes of 1.07mm x 1.07mm and 0.3mm x 0.3mm, and are immediately available for sampling and order. ■

## Osram OS Improves Temperature Dependent Efficiency of Osolon SSL LEDs by 25%

Osolon SSL-LEDs by Osram Opto Semiconductors stand for high light output. The new generation of high-power-LEDs will be appreciated by users for its improved performance, with an efficiency increase of approximately 25 percent. Additionally, the luminous flux of the LED at elevated temperatures has now been stabilised. In doing so, it is possible to retain a virtually constant luminous efficacy, despite high application temperatures. Thanks to this optimisation, the luminaire design is significantly simplified.



**The new Osolon SSL LEDs by OSRAM Opto Semiconductors generate a particularly high light output with a long lifetime on a small surface - even at high temperatures**



## CREE XLAMP® LIGHTING-CLASS LEDs



### XLAMP XB-D LEDs

OPTIMIZED TO DRAMATICALLY LOWER SYSTEM COST IN ALMOST EVERY LIGHTING APPLICATION

Double the lumens per dollar

Industry's smallest lighting-class LED, delivers up to 139 lumens at 1W, 6000K, 85°C



### XLAMP XT-E LEDs

OPTIMIZED TO REDEFINE THE INDUSTRY'S LED PRICE-PERFORMANCE CURVE

Double the lumens per dollar

Industry's highest performance lighting-class LED, delivers up to 148 lumens at 1W, 6000K, 85°C



### XLAMP MT-G EASYWHITE® LEDs

OPTIMIZED FOR HIGH-OUTPUT, SMALL-FORM-FACTOR, DIRECTIONAL-LIGHTING APPLICATIONS

Now available in brighter bins, expanded CRI and color options in both 6V and 36V options

High lumen output—up to 1670 lumens at 25W, 3000K, 85°C

# CREE XLAMP LEDs ARE APPLICATION OPTIMIZED FOR LOWEST SYSTEM COST

## REVOLUTIONARY!

Cree XLamp® Lighting-Class LEDs are purposefully designed to deliver the industry's best performance and optimized specifically for distinct applications. This makes it easy to design in the brightest, most efficient LED.

Our product portfolio enables revolutionary designs for either brighter, more efficient luminaires with fewer LEDs or space saving fixtures using less LEDs.

So whether you're designing exterior wide area lighting or a tightly focused indoor directional, you can have excellent performance and lower your system cost.

Get samples of Cree XLamp LEDs or contact a Cree Solutions Provider at [cree.com](http://cree.com) or call us at +800.533.2583

Get Cree reference designs at [cree.com/ref](http://cree.com/ref)

VISIT CREE AT L+B HALL 4.2 STAND G71 AND LIGHTFAIR BOOTH 130 TO SEE THE LATEST LIGHTING-CLASS LED COMPONENTS



With the new generation of Oslon SSL LEDs, Osram Opto Semiconductors presents a particularly temperature stable light source. The LED provides a luminous flux of typically 98 lm in warm white (3,000 K), with an operating current of 350 mA at an application temperature of 85°C in the chip. With these data, it is among the most efficient 1 mm<sup>2</sup> Chip-LEDs presently to be found on the market. The combination of higher luminous flux and reduced forward voltage of 3.1 V equals an efficiency increase of approximately 25 percent, when compared with the previous generation. For manufacturers of lighting solutions, this makes luminaire development much easier: a smaller number of LEDs attains the same luminous flux, as well as the same efficiency as before.

#### Technical Data (at 350 mA operating current):

- Dimensions: 3 mm x 3 mm
- Radiation characteristic: 80° / 150°
- Lifetime: > 50,000 hours (L70/B50 at T<sub>J</sub>=125°C)
- Light colors and CRI: 3,000 K: CRI 80 min. / 5,000 K: CRI 70 typ.
- Luminous efficacy: 3,000 K: typ. 96 lm/W / 5,000 K: typ. 111 lm/W (@T<sub>J</sub> = 85°C)
- Luminous flux: 3,000 K: typ. 98 lm / 5,000 K: typ. 113 lm
- Forward voltage typ: 2.9 V
- The product portfolio is continually being expanded by additional color temperatures.

#### State-of-the-art technology in use:

The latest developments in chip technology, converters, and package are the secret to the performance optimization of the Oslon SSL. The higher temperature stability of its luminous flux, even when operating under "hot" application conditions, significantly simplifies thermal management. "This efficiency enhancement not only implies a reduction of the initial costs incurred by our customers, it also makes the development of luminaire solutions so much easier," says Martin Wittmann, responsible marketing manager at Osram Opto Semiconductors.

#### Particularly small and bright:

The new Osram Oslon SSL LEDs are available in the light color "warm white" (3,000 K), suitable for interior lighting (type EC), for instance, in downlights, as well as in "cold white" (5,000 K), for use in exterior lighting (type PC). As with the previous products of the OSRAM Oslon SSL-range, also the new arrivals are available in the small component size of 3 mm x 3 mm and offer two different lenses.

## Cree Optimizes Price-Performance with the New XT-E LED

Cree, Inc. announced a breakthrough in LED technology that completely redefines the lighting industry and erases old assumptions about up-front LED cost and performance. The Cree XLamp® XT-E White LED delivers twice the lumens-per-dollar of other LEDs and features the highest performance and efficacy in the industry, based on a new silicon carbide technology platform.

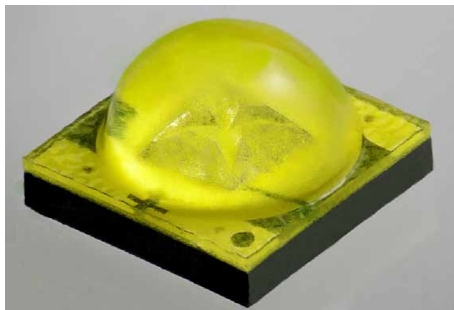

**Cree's XLamp® XT-E White is designed to accelerate LED adoption and lower system cost**

"Cree has a history of delivering excellent LED solutions and the XLamp XT-E LED has exceeded our expectations," said Fritz Morgan, chief product officer, Digital Lumens, Inc. "We are committed to building the most energy-efficient industrial lighting systems and the XT-E LED enables us to do just that."

"With the XB-D LED, Cree changed the game and introduced a better price-performance curve. Now, with the XT-E LED, Cree continues to break barriers and extend its leadership on this new trajectory, delivering products that accelerate LED adoption," said Mike Watson, Cree senior director marketing, LED components.

Paul Scheidt, Product Marketing Manager at Cree, explained exclusively to LED professional: "The new XT-E LEDs are based on the XT-E royal blue LED, introduced in August 2011, which is basically an improved XP-E design. This is a great advantage for our customers. Since the XT-E White LED is a successor product to XP-E High Efficiency LED, the application for ENERGY STAR® qualification requires only 3,000 hours of XT-E LED LM-80 data, instead of the normal 6,000 hours."

"To achieve the enormous progress in price-performance, numerous technological steps were combined, starting with an advanced chip structure to phosphor optimization as well as adaptations of the thermal path using a new package design and the primary optics with a new dome geometry," Mr. Scheidt commented on the relevant technological advances. "As a result," he continued, "the XT-E can be driven harder than its predecessor, with up to 1.5 A, has a lower thermal resistance, an increased light conversion efficiency and an optimized outcoupling characteristics."

The XT-E LED more than doubles the lumens per watt of the XLamp XP-E LED family – providing up to 148 LPW at 85°C (or up to 162 LPW at 25°C) at 350 mA. The XT-E LED delivers exceptional performance in the popular 3.45 mm x 3.45 mm XP footprint and can be used for almost all lighting applications. By leveraging the XP footprint, customers can easily incorporate the XT-E LED in existing XP LED designs to shorten the LED fixture design cycle and improve customer time-to-market. ■

## Philips Lumileds Introduces LUXEON M for Outdoor and Industrial LED Lighting Solutions

Philips Lumileds introduced LUXEON M, an illumination grade LED designed specifically to simplify solution design, reduce costs, and provide the optic control and quality of light required by outdoor lighting applications as well as high-bay and low-bay lighting solutions.

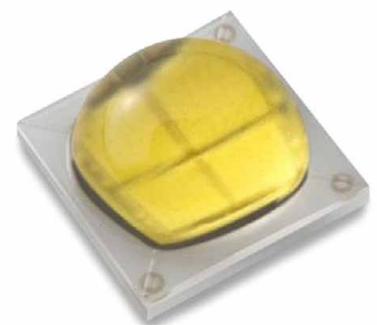

**LUXEON M simplifies design and lowers cost of outdoor and industrial lighting solutions with Freedom from Binning and leading performance**

“LUXEON M performance fundamentally lowers the cost and design complexity for a wide range of applications in the outdoor and industrial markets and equips lighting fixture designers with a source that allows them to meet the ever increasing demands of customers and regulators,” said Rahul Bammi, VP of Marketing for Philips Lumileds.

LUXEON M will be released with three different CCTs, 3,000 K, 4,000 K, and 5,700 K each with specified minimum CRI of 70. Each part is hot tested and specified at 85°C and delivers Freedom from Binning. LUXEON M will be broadly available in the second quarter 2012.

Initial specifications for LUXEON M include:

- More than 900 lumens at 700 mA and 85°C junction temperature
- Efficacy greater than 120 lm/W at 350 mA and 85°C junction temperature
- 12 Volt / 8 Watt package on AlN substrate

Utilizing Philips Lumileds’ latest die and phosphor technologies, LUXEON M will deliver the industry’s best lumen/\$ that can be realized using low cost, readily available drivers, optics and boards for simplicity. ■

## Philips Lumileds Introduces New and Improved LUXEON H

Philips Lumileds introduced its next generation high-voltage LED, LUXEON H. With significant performance enhancements, LUXEON H enables the broadest range of retrofit bulbs and space constrained applications while providing the light output, efficacy, and quality of light required to meet ENERGY STAR specifications.

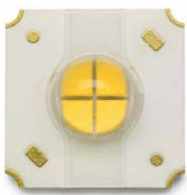

Old LUXEON H (right)

New LUXEON H (left)



The new LUXEON H (left) makes it possible to develop cost effective, compact LED bulb solutions like GU10s and candelabra (right: old LUXEON H version)

LUXEON H leads in real world performance:

- CCT: 2700K and 3000K with minimum 80 CRI
- Freedom From Binning
  - Single 3-step MacAdam Ellipse color space
  - No flux bins; no Vf bins
  - Color over angle specified at a low 0.02 du’v
- Hot tested and specified at T<sub>j</sub>=85°C
- Typical Efficacy: 90 lm/W at 40 mA, 100 V, T<sub>j</sub> = 85°C
- 100 V / 200 V package rated for 4 W – 8 W
- Typical Flux: 320 – 660 lumens at 20 – 90 mA and 100 V or 200 V

“LUXEON H is a major advancement that delivers unsurpassed quality of light in a package that’s easy to implement,” said Rahul Bammi, VP Marketing at Philips Lumileds. For the first time there is a practical solution for GU10 and other small form factor bulbs. Compared to other high-voltage or AC LEDs, LUXEON H delivers more light, better light, and better efficacy in a more cost effective package with proven LUXEON reliability.” ■

## Sharp Presents the New Generation of 10 W Mini Zeni LED

The new 10W Mini Zeni is based on the technical advances made in LED production, improving the efficiency by up to 47%. They are compact, lightweight, economical and significantly brighter than before. The 2nd generation now radiates with an efficacy of up to 106 lm/W, a greater luminous flux of up to 900 lm and is available with a (typical) CRI value of 82.

Line-up LED lighting module 10W "Mini Zeni" (CRI xx) at IF = 480 mA:

Model	GW5BMJ30K04		GW5BMJ40K04		GW5BMJ50K04	
LED Color	Warm White		Natural White		Pure White	
Color range X / Y in CE 1931 coordinates	0.435	0.403	0.381	0.435	0.403	0.381
Number of dies	60		60		60	
Dimension [L x W x H] mm	15 x 12 x 1.6		15 x 12 x 1.6		15 x 12 x 1.6	
Color temperature [K]	3.000		4.000		5.000	
CRI (TYP)	82		82		82	
Light output [lm]	840		880		900	
Luminous efficacy [lm/W]	99		103		106	
Supply voltage [V]	17,7		17,7		17,7	
Life time **at 90°C	40.000 h**		40.000 h**		40.000 h**	

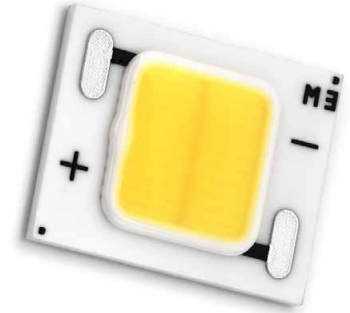

Sharp's new Mini Zeni offers with up to 106lm/W a 47% improved efficiency combined with higher luminous flux and CRI 82

Sharp has retained the dimensions of 15 x 12 x 1.6 millimeters unchanged, along with an aluminum ceramic plate as carrier material. The flat surface of the ceramic plate and the soldering points already in place make it possible to attach the modules to a suitable heat sink, without too much effort or additional connecting material, thereby achieving efficient heat dissipation.

The new types offer a light output of up to 900 lumens, a luminous efficacy of up to 106 lm/W in standard operation, high CRI values of 82 and a long service life of 40,000 operating hours at an operating temperature of up to 90°C. The new generation is specified for use with a forward voltage of 17.7 V and a forward current of 480 mA. But the arrays can also be operated using a current of up to 800 mA, whereby values of up to 1,300 lm can be reached. The color temperatures of the new white light LED arrays are in the range of 3,000 to 5,000 Kelvin.

The Mini Zeni LED modules from Sharp are suitable for numerous applications, e.g. spot lighting and for use in LED retrofit lamps. ■

## Cree Introduces the Next Generation of Lighting-Class LEDs

Driving the next generation of mainstream LED lighting adoption, Cree, Inc. introduces the breakthrough XLamp® XB-D LED. The first LED based on an innovative new Cree technology platform, the XLamp XB-D LED ushers in a new era of price-performance for lighting-class LEDs.

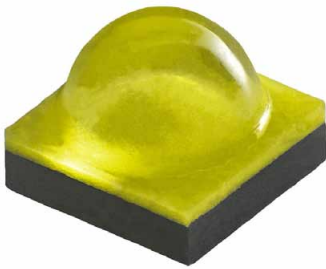

**Cree's XB-D LED delivers twice the lumens-per-dollar of other LEDs providing up to 139 lm/W in cool white and 107 lm/W in warm white at 350 mA @ 85°C**

The XB-D LED delivers twice the lumens-per-dollar of other LEDs, in the industry's smallest lighting-class footprint of 2.45 mm x 2.45 mm. The XB-D LED is 48 percent smaller than the XLamp XP package and ideal for lighting applications where high lumen density and compact light sources are required. This next generation of lighting-class LEDs can enable significantly lower prices for LED lighting products by using up to three times fewer LEDs, three times fewer optics and smaller PCBs than current designs.

"With this new platform Cree has fundamentally redefined the price-performance paradigm for our components customers," said Mike Watson, Cree senior director of marketing, LED components. "It's not enough to just make LEDs brighter—it's also about improving product payback and market acceptance of LED lighting."

Leveraging Cree's proven silicon carbide technology and expertise, the XB-D LED delivers up to 139 lumens and 136 lumens per watt in cool white (6000 K) or up to 107 lumens and 105 lumens per watt in warm white (3000 K), both at 350 mA and 85°C.

XB-D LEDs are also compatible with most existing XP family secondary optics, which can speed the optical design process and create direct cost savings for existing XP family-based designs. ■

## Seoul Semiconductor Releases Acrich2 Linear Module

Seoul Semiconductor (SSC) announced its release of AC LED type fluorescent Acrich2 Linear Module. The Acrich2 Linear Module lifetime is twice as long as DC-driven LED and cuts actual power usage by half.



**SSC's Acrich 2 is now available as a linear module**

Compared with the existing linear module driven by direct current, the main feature difference for Acrich2 Linear Module is the removal of AC/DC converter and the consequent optimized design. As a result, the electrolytic capacitor, which contributes to the reduction of LED light life, is removed from a converter increasing to a light lifetime that is twice as long.

Lighting companies have preferred the ballast compatible system when fluorescents are replaced by LED lamps. The system leaves a ballast, necessary for fluorescent installation, untouched and only replaces LED lamps by introducing separate LED converters. However, this is less energy efficient.

As a result of high-level technology, the Acrich2 Linear Module eliminates both a ballast and a converter and thus secures LED fluorescent safety. In fact, the power factor increases to 97% and power efficiency is increased to 90%.

"Armed with optimized simplistic system design, the Acrich2 Linear Module is a state-of-the-art product that outperforms existing non-ecofriendly fluorescent lamps and direct current LED fluorescent lamps", remarked Manuel Zarauza, Managing Director of Seoul Semiconductor. "With the doubly long life span and lower carbon dioxide emission, customers will be able to actualize eco-friendly lighting while paying lower electricity bills." ■

## Optogan Announces the Scalable World Class 500W LED Lighting Module X10

Optogan presented its new high power Chip-on-Board module, X10, which is based on the vision of scalability and lean processing for luminaire manufacturing.

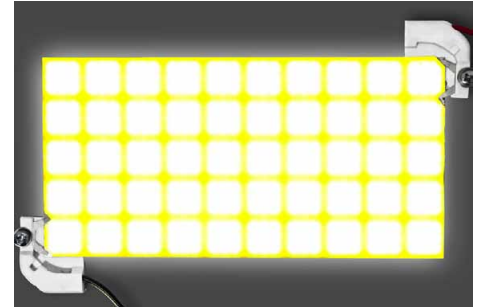

**Optogan's X10 50-segments module can be easily divided into smaller elements down to a 1cm² small 10W module**

The X10 a COB-block, consisting of 50 segments, can be easily divided into LED elements of smaller sizes and power, and each of them can be used in separate light fittings. The smallest segment of Optogan's X10 consists of a 1cm² ceramic board and consumes 10 W (1 A, 10 V), with efficacy levels already exceeding 100 lm/W.

The connections of the sub-modules are opened, where required, either by industrial means, or a simple mechanical operation. Due to various sizes and forms of the elements, they can be used in halogen lamp analogues, light fittings, fixtures with reflectors, as well as in industrial or street lights. The ceramic base and product material selection is based on long life performance by design.

"X10 represents Optogan's new flagship, offering modular solutions, economical and simple to use, for that additional degree of freedom in lighting design. Coupled with state of the art module efficiency over 100 lm/W, the X10 provides our clients the maximum possible variety in steps of 10 W reaching up to 500 W", says Markus Zeiler, General Manager of Business Unit International at Optogan GmbH in Germany. ■



ARROW ELECTRONICS

# Full spectrum of lighting solutions.

From connector to reflector, from product design to ready-to-assemble LED systems.

We offer the whole range of lighting solutions from one source. The unique Arrow line card includes both components and complete systems such as thermal management and power. We are here for you with in-depth technical knowledge and many years of experience: from lighting engineering support and product design to comprehensive systems integration services and interactive applications such as our Design Tool, which allows you to create customised LED lighting solutions. Arrow and lighting technology – simply brilliant.

[lighting-europe.arrow.com](http://lighting-europe.arrow.com)



## LED Engin's New Connector Boards Enable Faster, Easier Assembly of SSL Fixtures

LED Engin, Inc. announces a family of metal-core printed circuit boards (MCPCBs) with integral connectors that eliminate soldering during the assembly of LED fixtures. The poke-home connectors, which accept 18-24 AWG wires, offer quick, solderless assembly of fixtures and can eliminate the need for OEMs to use sub-contractors because the work can be taken in-house.



**LED Engin LZC 12 and LZP 24 emitters are now available on connector boards for easy assembly of SSL fixtures**

**Main product data:**

Type	No. of Dies	MCPCB Thermal Resistance	Max. Power	Voltage Options
LZC	12	0.6°C/W	40W	24V / 48V
LZP	24	0.1°C/W	80W	24V / 48V

The boards utilize a common 50mm footprint for both the LuxiGen LZC 12 die and LZP 24 die series of high flux density emitters, helping OEMs to standardize fixture designs around a single form factor. The low thermal resistance MCPCBs mean that heat is effectively conducted away from the LEDs, so that the emitters can be driven up to 1000 mA / die to maximize flux density without adversely affecting operating life or reliability. The boards feature mounting holes for LuxiGen TIR lens-holder legs for easy integration with secondary optics. There are mounting-screw cutouts to facilitate easy attachment of a heatsink, further simplifying the assembly process. The boards include one connector for the LED and one for an on-board thermistor to be used with common constant current sources with thermal feedback. ■

## Philips Lumileds LUXEON K for Retrofit and Downlight LED Lighting Applications

Philips Lumileds introduced LUXEON K, its illumination grade array that charts a new direction for downlights and retrofit bulbs so that solutions can come to market more quickly and at a price that drives market adoption. LUXEON K arrays provide thousands of lumens of light output and will be available in three different CCTs with a typical CRI of 85, and with five configurations of 4-24 emitters per array, in early Q2 of this year.



**LUXEON K arrays are engineered to support rapid development of downlight and retrofit bulb solutions where quality of light and efficacy are essential**

**LUXEON K Performance Overview:**

- CCT: 2700 K, 3000 K, 4000 K,
- Guaranteed minimum CRI of 80, and typical 85
- Typical flux at 700 mA: 620 to 4455 lumens
- >100 lumens / Watt at 350 mA, Tj 85°C, 3000 K CCT
- Hot testing and specification at 85°C
- Freedom from Binning: Single 3-step MacAdam Ellipse color space no flux bins; no V<sub>f</sub> bins

“LUXEON K extends our portfolio of illumination grade LEDs engineered to optimize end-user satisfaction of specific applications,” said Rahul Bammi, VP Marketing at Philips Lumileds. “For downlights and retrofit bulbs, LUXEON K provides a unique approach that delivers the highest, most consistent quality of light in an easy-to-implement array. Our hot testing and specification at 85°C, and freedom from color, flux, and Vf binning, makes LUXEON K the simplest of LEDs to specify and use.” ■

## Dialight's New 170W DuroSite® LED High Bay Fixture: 17,000 Lumen, 100 Lumens per Watt

Dialight, the innovative global leader in LED lighting technology, announced the launch of its new 17,000-lumen, 170W DuroSite® LED High Bay luminaire, designed to deliver superior lighting quality and clarity in a wide range of industrial lighting applications. The product is currently UL1598/A and CSA 22.2 certified and set to undergo CE compliance testing to broaden availability in the coming months.



**Flat, powerful, efficient and reliable. Dialights new 170W DuroSite® LED High Bay Fixture**

The new 100 lumen per Watt fixture is the latest addition to Dialight’s expanding High Bay product line that now offers lumen outputs ranging from 8,000 to 17,000, including several models certified for hazardous location use. LED low bay models are also available at 6,000 lumens for lower ceiling height applications, such as parking garages and cold storage facilities.

Instant-on capability allows the units to be paired with an occupancy sensor and/or dimmable components for enhanced energy efficiency. The units operate on an integrated universal power supply at 100-277VAC, and are well-suited for easy changeout from conventional HID light sources, such as metal halide and high pressure sodium. Each unit is backed by Dialight’s 5-year full-performance warranty for exceptional long-life durability which encompasses the entire luminaire from fixture housing, lens and finish to LED light engines and integrated power supply.

In addition to being UL1598/A and CSA listed, the 17,000 lumen product is also IP66 certified for use in outdoor and wash down locations, in addition to indoor use for warehouses, manufacturing facilities and cold

storage applications. At just one-fourth the overall fixture height of conventional HID fixtures, the low-profile high bay reduces dust and dirt accumulation, as well as interference with air circulation or other structures. ■

## New Fully IP-65 Rated Indoor / Outdoor LED Display from PixLED

Pixled launched its new Pixled F-10i/o - the first of two new fully IP-65 rated indoor / outdoor LED displays – at the Integrated Systems Europe (ISE) exhibition in Amsterdam.

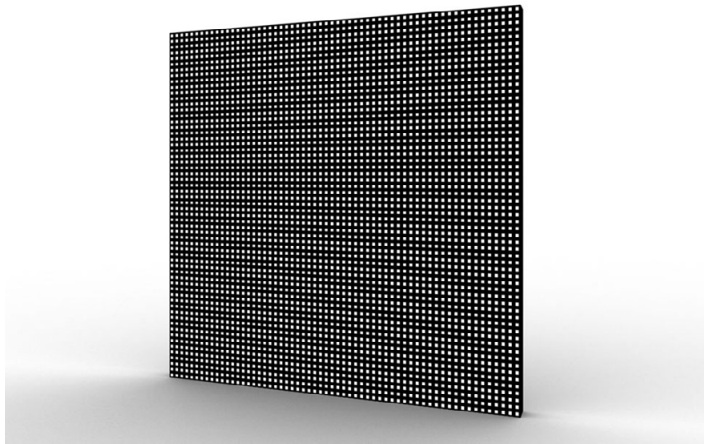

The new Pixled F-10i/o was presented at the Integrated Systems Europe (ISE) Exhibition in Amsterdam at the end of January, 2012

The new product features a real pixel pitch of 10.4 mm resolution and is populated with 3 in 1 SMD chips. The die-cast aluminum modules measure 50 x 50 x 4.5 cm and are ultra-lightweight at just 28 kg per square meter. With 5,000 Nits of brightness, and the IP-65 rating applying to both front and back of the screen, Pixled F10 i/o is the ideal product for a wide variety of indoor and outdoor projects and applications. As with all Pixled products, it is robustly built, quality engineered and ready for the rigors of touring and events environments.

The tiles have been developed specifically with rental & staging companies in mind, and are sold in combination with European designed and manufactured hanging brackets, foot system and flight cases. This ensures full portability and very quick set up and tear-down times.

The F-10i/o display will have a primary spot on Pixled's booth at ISE 2012, and in addition to this, other Pixled products highlighted will be the only European cross rental sources of 6 mm and 15 mm LED screen surface.

Pixled F-6 was shown in combination with its full HD Mitsubishi processing option.

Also new from Pixled is the full "Linx" (by Radiant) product line, which will be displayed in a creative setup utilizing all three of the latest Linx LED surfaces – the Linx-18, Linx-25 and Linx-30. Pixled was recently appointed as the exclusive European distributor for Linx. ■



**heatpipe thermal module**

Heatpipes for a fast dissipation of the LED power.

advantages:

- quick transportation over long distance
- fast reaction of power peaks because of a very low thermal resistance



**crimped-fin heatsink**

Patented production process of radial heatsinks for maximized surface at minimized weight.

advantages:

- high cooling efficiency without fans
- light weight compared to extrusion profiles
- no machining
- more flexibility of the heatsink design



**reflector ring**

Aluminum rings made by lathing to easily mount the reflector to the lamp housing.

advantages:

- optimized design for mounting the reflector and heatsink together by using the aluminum ring.



**EKL**<sup>®</sup>

LED cooling

EKL AG  
Nadlerstrasse 8-10  
88299 Leutkirch  
Deutschland

Telefon: +49(0) 7561/8837- 0  
Fax: +49(0) 7561/8837- 20  
Email: info@ekl-ag.de

- visit us at LpS 2012 in Bregenz, Austria -



**Smart LED Lighting out of one Box**



LED Luminaires  
LED Controller  
Power Supply Unit  
Cabling

Compatible with DALI or DMX

**Intelligent LED Lighting Systems:**  
Ready for Use, Energy Efficient, Digital Dimmable

Learn more about dilitronics products and visit us at:  
[www.dilitronics.com](http://www.dilitronics.com)

light + building Hall 4.0 Booth G90 | Hall 4.2 Booth J21

## LEDiL Announces Availability of Lenses Qualified for Use with Cree's New XB-D LEDs

LEDiL announces the availability of 40 lenses qualified for use with Cree's new XLamp® XB-D LED, which boasts the industry's smallest lighting-class footprint of 2.45 mm x 2.45 mm. The wide-range of lens styles offered by LEDiL provides multiple design choices and beam patterns in the quest to drive higher performance and reduced system cost. Use of secondary optics characterized for a specific LED and engineered to provide usable light only where needed helps to reduce the number of LEDs required in a lighting system, which leads to smaller power supplies and heat sinks and reduced system cost.

Available single-position TIR (total internal reflection) lenses include 9.9 mm, 16.1 mm and 21.6 mm outside dimension, with FWHM beam angles from 8° through 73°, plus many oval beam patterns.



**LEDiL's new lenses for the Cree XB-D LEDs are available as single lenses or three-position or four-position lenses**

The lenses cover almost all lighting needs and are often deployed in wide-area illumination, cove and wall-wash, task lighting and indoor effect lighting. Three-position and four-position lens arrays, in 35 mm, 40 mm

and 50 mm diameter, achieve beam angles between 11 degrees to 52 degrees FWHM, are ideal for development of highly efficient MR-type spot lights. Designers of street lights, parking lot and garage lights, and high bay and similar commercial lights can choose from five different STRADA lenses that offer asymmetric light distribution patterns.

Under-cabinet and interior mood lighting is also enabled with the performance of XB-D and LEDiL's range of optical solutions. ■

## NXP Extends LED Driver ICs for Compact, Non-Dimmable Lamps

NXP Semiconductors N.V. announced the availability of several new LED driver ICs in its SSL2108x family for compact, non-dimmable retrofit lamps, following the success of the SSL21081. With the addition of the SSL21082, SSL21083 and SSL21084, NXP now provides a single platform for lamp designers developing for 100V – 120V and 230V mains voltages, as well as all power ranges up to 25 W. Based on GreenChip™ technology, the SSL2108x family has been optimized for non-isolated topologies with high output voltages, and for applications in which compatibility with triac dimmers is not required.

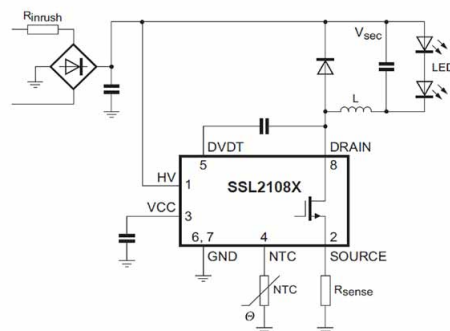

**NXP SSL2108x typical application schematic and block diagram**

Compact, non-dimmable LED lamps are growing in popularity, particularly in markets such as Japan. The SSL2108x family offers a best-in-class solution for these markets, with a high level of efficiency (up to 95% as measured on reference boards); a high level of integration (enabling easy design-in of a full application with only 14 components and a very small PCB area of 18 x 22 mm); and a

very low electronic bill of materials (eBoM). The NXP SSL2108x family of devices also delivers tight LED current regulation (better than 5%); a full set of protections, including built-in LED temperature protection via input from an NTC temperature sensor; and an integrated MOSFET.

“The adoption of compact, non-dimmable LED lamps is growing strong in both the residential and commercial lighting markets worldwide. While energy efficiency and cost are key concerns, we’re finding that consumers and business users also prefer not to sacrifice performance. The SSL2108x family of highly efficient, high-voltage LED driver ICs addresses this demand. The SSL2108x family also offers a single platform that makes it straightforward for LED retrofit lamp manufacturers to design applications for the 100V, 110V, 120V and 230V markets and for power ranges up to 15 W and 25 W,” said Ryan Zahn, general manager, lighting solutions product line, NXP. ■

## Fairchild LED Driver for TRIAC-, Analog- and Non-Dimming Lamp Designs

To help designers address challenges of residential and commercial LED lighting applications up to 20 W including bulb, down lighting (GU10/E17, E26/27, PAR30/38) and Tube/Bar, Fairchild Semiconductor developed the FL7730 single-stage primary side regulation (PSR) controller with power factor correction (PFC), TRIAC and analog dimming compatibility, as well as the FL7732 for non-dimming applications.

The FL7730 is an active PFC controller for single-stage flyback topology application. The device supports both TRIAC and analog dimming. Implemented with Fairchild's unique analog sensing technology, the device can achieve TRIAC dimming control without flicker over the full range of 0 to 100% light output.

The FL7730 and FL7732 combine primary-side regulation and a single-stage PFC topology to minimize total bill-of-material (BOM) count, such as an input electrolytic capacitor and feedback circuitry, therefore allowing for a more compact, longer life, and lower system cost design.





## The Right LED for the Right Application

- Controlled Color Shift < 200K CCT
- Efficiency WW > 85 lm/W; CW > 100 lm/W
- Low Thermal Resistance < 3K/W
- High CRI (> 80 CRI)
- Easy Assembly (No reflow needed)



EVERLIGHT always provide the best solution to fulfill your needs.

For more information please enter [www.everlight.com](http://www.everlight.com)

Please visit us during Light + Building in Frankfurt

Date: April 15 - 20 | Venue: Frankfurt Fair and Exhibition Centre | Booth Number: 4.1 K10

# EVERLIGHT

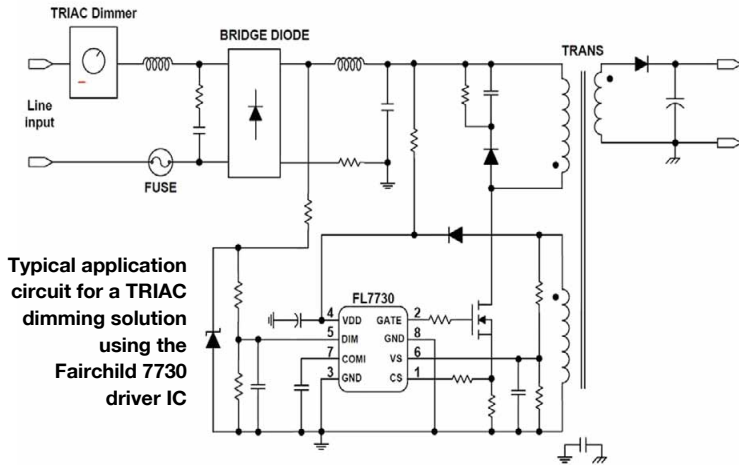

**Typical application circuit for a TRIAC dimming solution using the Fairchild 7730 driver IC**

To improve power factor and THD, both devices feature constant on-time control with an internal error amplifier and low bandwidth compensator. Precise Constant Current accuracy/control ( $\pm 5$  percent) regulates accurate output current, independent of input and output voltage, allowing designers to achieve high and improved lighting quality. Operating frequency is proportionally adjusted by output voltage in both devices to guarantee DCM operation with optimized PF/THD and simpler design.

Excellent PF ( $\geq 0.9$ ), low total harmonic distortion (THD) (Class C) and power efficiency of up to 85 percent for the FL7730 – greater than 85 percent for the FL7732 – allows these devices to meet worldwide energy saving regulations. ■

## LED Driver Controller from Diodes Inc. for Demanding Lighting Applications

Diodes Inc. announced the ZXLD1371 LED driver controller. By extending input voltage operation from 60 V down to as low as 5.0 V, the ZXLD1371 has been designed to handle as broad a range of applications as possible, including those subject to the greatest variance in input voltage, such as automotive lighting and 12V AC powered systems. Its ability to control an external driver FET in buck, boost and buck-boost driver topologies makes it an all-in-one solution, capable of driving as many as 20 high-current LEDs in boost mode with a high level of accuracy.

**Typical application diagram for buck-boost solution utilizing a thermistor and TADJ**

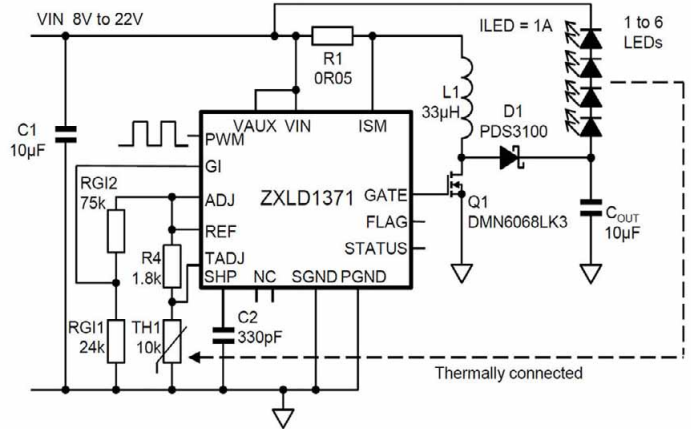

**Features:**

- 0.5% typical output current accuracy
- 5 to 60 V operating voltage range
- LED driver supports Buck, Boost and Buck-boost configurations
- Wide dynamic range dimming
  - 10:1 DC dimming
  - 1000:1 dimming range at 500Hz
- Up to 1 MHz switching
- High temperature control of LED current using TADJ
- Available in automotive grade with AEC-Q100 and TS16949 certification
- Available in “Green” molding compound (No Br, Sb) with lead free finish! RoHS compliant

Employing patent pending control loops and single resistor high-side current sensing, the ZXLD1371 will deliver a typical output current tolerance of 1%, helping to produce improvements in brightness control and lamp luminance matching. The LED driver controller offers users dimming over a wide dynamic range, through separate 20:1 DC dimming and 1000:1 PWM dimming options, resulting in higher accuracy light control particularly at lower brightness levels.

To further improve the reliability of LED lamp systems, the ZXLD1371 provides thermal management of LEDs via a dedicated external thermistor input, which combined with fault diagnostic outputs reporting LED load and driver status, helps to increase LED longevity.

Switching at up to 1MHz, the TSSOP-16EP packaged LED driver controller will also help minimize circuit size by reducing the value of the external inductor. ■

## GlacialPower Announces GP-LS200P Series LED Drivers

Designed for outdoor applications such as streetlights, the GP-LS200P series efficiently regulates voltage and power consumption. With these drivers, outdoor lighting can benefit from the advantages of LED lighting including lower power consumption, natural-looking light with no perceptible flickering, and extremely long product lives.



**GlacialPower's new GP-LS200P driver series promises efficient and effective AC to DC power conversion for outdoor use**

GlacialPower's new LED driver series effectively transforms AC voltage ranging from 90 to 295V into useable DC voltage. The four models of the GP-LS200P series have a DC voltage output from 12 to 48 V. Additionally, the Power Factor Correction (PFC) of the power driver is also highly specialized and maintains a clean and pure sine waveform of current to improve electric power quality – enhancing LED life and reducing power losses from electric power pollution.

# YOUR SOURCE FOR LED & LED LIGHTING COMPONENTS

- A world of 10,000 LED lighting components and design solutions
- LEDs, Power and Thermal management, Interconnect and Optic products available
- Global portfolio of industry leading manufacturers



[farnell.com/lighting](https://www.farnell.com/lighting)

# A UNIVERSE OF LED MEASUREMENT SOLUTIONS

## INTEGRATING SPHERES & COMPLETE SYSTEMS

StellarNet is the world-wide provider of low cost, portable test & measurement systems. NIST-Traceable spectrometers provide absolute intensity values for reliable analysis of LEDs, OLEDs, and lighting.

- Irradiance (watts/m<sup>2</sup>, μwatts/cm<sup>2</sup>)
- Illuminance (lux)
- Radiant Flux (watts)
- Color temperature (CCT)
- Chromaticity coordinates x,y
- Dominant Wavelength & Purity
- Luminous flux & Luminance

[www.StellarNet.us](http://www.StellarNet.us)



Tampa, FL, USA +1 813-855-8687

Built to be smaller than its competitors, the GP-LS200P series maintains optimal temperatures with cooling by free air convection. Adding the fact that the drivers set up almost instantly – 1.5 seconds – makes it an ideal solution for high brightness LED outdoor applications. ■

## eldoLED Announces 50 W AC LED Driver Series

eldoLED announces the 50W SOLOdrive, DUALdrive and POWERdrive AC. The 50W AC series features broad compatibility (0-10V, DALI and DMX/RDM) and can be used in a great variety of lighting application areas. The 50W LED drivers naturally offer the eldoLED signature features: smooth dimming, user configurability and LEDcode.



**50 W AC SOLOdrive, POWERdrive and DUALdrive**

### LED dimming:

eldoLED drivers excel in smooth, flicker-free dimming and dim down all the way to 0.1% - irrespective of whether the driver is part of a 0-10 V, DALI or DMX environment.

### Configure for different applications:

The driver's configuration can be changed to perfectly fit different application requirements. From exact current output values and dimming related settings for SOLOdrive and DUALdrive to extensive DMX-related settings for POWERdrive.

### Extend the feature set with LEDcode:

LEDcode, available on all eldoLED AC driver series, lets you extend the driver's feature set, adding value into your lighting application. LEDcode enables seamless integration of time, motion, and brightness based intelligence for maximum energy and operational efficiency. ■

## MTL Surge Protection for LED Lighting Systems

LED lighting technology continues to grow in popularity due to its fast start up, low energy consumption, long-life and reliability. This is particularly true in markets that include home automation lighting, commercial road and street lighting, highway lighting, sign lighting and industrial lighting. Since LEDs are more susceptible to surges and transients, realizing the maximum potential from LED lighting requires high performance surge protection.



**This MTL Surge Protection Series features Metal Oxide Varistor (MOV) technology and high energy discharge tube (gdt) technology**

MTL, a division of Cooper Crouse-Hinds, announces the LS10 (serial) and LS12 (parallel) Series of surge protectors purpose-built to protect LED lighting from transients and surges generated by lightning and switching transients.

The LS Series is suitable for harsh environments, including outdoor mounting, and provides high performance circuit protection that saves valuable LED lighting assets, reduces maintenance, prevents unwanted failures and decreases degradation damage for longer lifetimes.

### Features include:

- Protection of LED lighting systems and drivers
- Space saving footprint for mounting in confined locations
- Protection for 120 V - 347 V and 480 V
- High performance to size ratio
- Fully automatic operation
- UL1449 3rd Edition Type 4

### Recognized Component:

- Rated for harsh environments
- 10 year product warranty



## Wallwasher Lens

Generating a narrow, clear cutting edge or uniform medium beam by adjusting the distance of the focal distance is achievable with this new developed lens, LL01LU-ABW1050L. This optics delivers elliptical beam and is suitable with various types of lighting application, such as wall washer in architectural lighting.

**2012  
NEW!**

Field Angle 10° x 50°  
FWHM 3° x 50°  
DxWxH(mm): 34 x 29 x 3

LED: Cree XPE / XPG  
Edison Federal 3535  
Lumileds Rebel ES  
Nichia 119 / 219



**LL01LU-ABW1050L**



**Street Light Lens**

**LL01ED-AU70120L**  
FWHM 70° x 120°  
DxH(mm): 94 x 42 x 30  
LED: Bridgelux ES  
Edison 100W



**LL01LU-AEV50150L**  
Adhesive tape available  
FWHM 50° x 150°  
DxH(mm): 18 x 8.5 x 6  
LED: Cree XPG  
Lumileds Rebel ES



**COB Lens**

**LL01CR-PVxxL-Mx**  
Field Angle 45°、60°、80°  
FWHM 25°、30°、45°  
DxH(mm): 45 x 23.6  
LED: Bridgelux LS  
Cree MTG  
Lumileds Luxeon S



**LL01CR-ABHxxL**  
Field Angle 100°、100°  
FWHM 40°、60°  
DxH(mm): 50 x 10.4  
LED: Bridgelux ES/LS/Deco  
Cree CXA2011  
Citizen CL233 / CLL030  
Edison Edipower II  
Xicato XSM



**Single Lens**

**LL01CR-YJxxL-Mx**  
Field Angle 40°、60°、80°、100°  
FWHM 25°、30°、40°、60°  
DxH(mm): 21 x 13.9  
LED: Cree XML-EZW/AWT  
Edison Federal FM



**LL01NI-AAFxxL-Mx**  
Field Angle: 100°  
FWHM 60°  
DxH(mm): 11.8 x 6.6  
LED: Cree MX6  
Nichia 183



**Color Mixing Lens**

**LL01ED-CV15L-Mx**  
Field Angle 30°  
FWHM 15°  
DxH(mm): 19.3 X 12.5  
LED: Edison Edixeon A/S



**Reflector**

**LL01CR-YNxxL**  
Field Angle 15°、40°  
FWHM 10°、20°  
DxH(mm): 19 x 15.3  
LED: Cree XPE / XPG  
Edison Federal 3535

## Ledlink Optics, Inc.

Founded in year 2008, Ledlink is professional in designing and developing the secondary optics for LEDs industry. We attach great importance to tooling precision and production quality; moreover, many of our new designs are rewarded with patent authentications. As the functional aspect, the secondary optical design includes COB Lens, Convex Lens, Asymmetrical Street Light Lens, Oval Lens, Diffuser Lens, Single or Multi-Cluster Lens, and Reflectors, etc.

Our product line can fulfill all customized and application demands.

The Series features Metal Oxide Varistor (MOV) technology and high energy discharge tube (gdt) technology with a state-of-the-art failure disconnect network that provides contractors, installers, LED system OEMs and end-users with years of peace-of-mind operation. ■

## Celcion™ Thick Film Material System that Outperforms Traditional MCPBCs

Heraeus Celcion is a Thick Film Materials System designed to build circuits directly onto aluminum substrates. Traditionally, MCPBCs are constructed using a subtractive process, adding then removing material. This takes time and often wastes costly material. Celcion, however, incorporates a selective additive deposition process flow—using material only where it's needed. The result is reduced processing steps, less material consumption and simplified bill of materials.

Celcion has been independently verified to deliver industry-leading thermal connectivity and high dielectric breakdown strength, compared to traditional MCPBCs. All materials can be fired at less than 600°C, and it is compatible with 3,000, 4,000, 5,000 and 6,000 series aluminum substrates.

### Runs 10°C cooler:

By removing the thermal interface material altogether, Celcion provides a more direct connection to the Al heat sink. This reduces the heat spreading layers and thermal footprint, allowing Celcion circuits to run 10°C cooler than MCPBCs—performance you can actually see through a thermal gun.

### Reduce LED cost:

Because Celcion circuits run 10°C cooler, you'll see an immediate increase in lumen power. This means designers can reduce the number of LEDs needed by up to 20%—without sacrificing performance. With less LEDs needed, you can dramatically decrease your production costs.

- Reduce LED chips
- Reduce heat sink size
- Higher output/lumens
- Increase LED life

### New design options:

Celcion provides the same fit, form and function as traditional MCPBCs. But with improved performance benefits, such as reduced heat gain, your designers will be able to reduce the size of the Al heat sink and create new, streamlined design configurations, without sacrificing performance.

Because of Celcion's unique additive printing process, not only will you reduce the processing steps, number of materials and amount of materials consumed, but your design team can also make quicker and less design changes than traditional MCPBCs.



**Celcion™ is a thick film material system that outperforms traditional MCPBCs**

Celcion is ideal for high-power applications, including high-power LED substrates (>1W input) found in general illumination, signs, signals and displays. You'll also notice increased performance benefits in power electronics, heaters and auto manufacturing, to name a few. ■

## TE Connectivity Solderless LED Socket for Nichia COB-L Series LEDs

TE Connectivity announces a new addition to its solderless LED socket series -- the Type NL2 socket for quick termination of NICHIA COB-L LEDs. This new offering, which provides a reliable mechanical and electrical connection of an LED onto a heat sink, enhances TE's existing broad portfolio of solderless LED sockets.

Project:  
Taipei Ming Yao Department Store  
System & Light Show Design : ARC SSL  
Location: Taipei, Taiwan  
Date: August, 2011



## Lighting solutions for architectural and commercial project

### Ming Yao Department Store in Taipei

The intelligent lighting control system with ARC high performance products creates ideal solutions and provides a perfect combination of a lighting quality and cost efficiency.

For an ideal light show displaying at a low cost, optimize your LED lighting solutions with ARC Solid-State Lighting Corp.

ARC SSL strives to develop LED technology not only into the brighter future, but also makes it to be the ART of the lighting design.

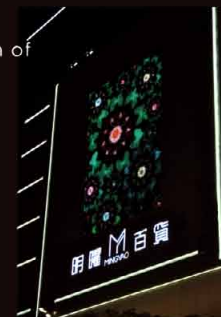

light+building

Frankfurt am Main  
15 – 20. 4. 2012

ARC Solid-State

Lighting Corporation  
Hall 9.0, Stand A69E

9.0A 69E

ARC SOLID-STATE LIGHTING CORPORATION  
Tel : +886-2-8227-8217 Fax : +886-2-8227-3747  
Web : www.arcslight.com.tw E-mail : info@arcslight.com.tw  
Address : 14F-2, No.700, Zhongzheng Rd., Zhongho Dist., New Taipei City 235, Taiwan

ARC

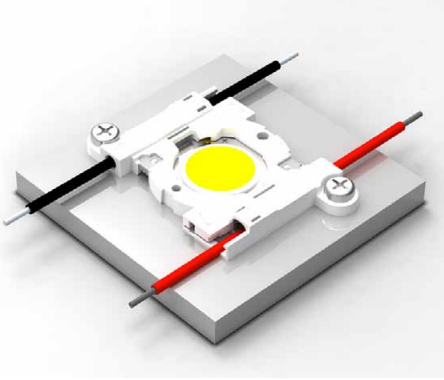

**The most recent member in TE's solderless LED sockets is for the Nichia COB-L Series LEDs**

Connecting LEDs without the need to solder manually offers many benefits. Soldering is a time-consuming process, as LEDs are difficult to solder to, with solder flux splatter possibly damaging the light emitting area of the LED. In addition, a solder termination is awkward to undo and over time can become a weak point that can considerably reduce the reliability of the connection. The heat from the soldering process can also transfer to the LED and shorten its lifespan. In contrast, the solderless socket enables greater uniformity in connections with a strong yet removable connection and no need for heat application.

The one-piece connector assembly features TE's proven poke-in wire termination method for 18 through 22 AWG solid, 18 through 20 AWG prebonded and 18 AWG stranded wires. Termination to the COB-L LED is simplified with locating features that position the LED into the socket during the assembly process. This creates mechanical protection for the ceramic LED edges. In addition, the integrated polarization feature enables a secure and lasting connection, which fits solid, stranded or fused wire. This makes the installation process extremely quick and easy with minimal manual work, helping to reduce time and costs.

**Additional product features include:**

- A cleared area designated for reflector mounting that accepts custom or commercially available optics
- UV-resistant housing material to prevent housing discoloration
- Molded polarity indicator on housing

The socket has been designed specifically for chip-on-board LEDs from NICHIA. It is suitable for applications such as retail lighting, commercial down lights and high bay lighting. It is UL-recognized to UL 1977 for use in UL 8750 applications and is RoHS compliant. ■

## Gamma Scientific's New Spectrometer for Quick and Easy LED Testing

Gamma Scientific has developed a low-cost spectrometer to provide quick and accurate testing for LEDs. The RadOMA Lite is a high-performance, linear CCD array spectrometer designed to test LED intensity and total flux.



**RadOMA Lite spectrometer with 15cm integrating sphere for LED testing and its single components**

With near real-time speed and NIST-traceable measurement, the RadOMA Lite provides maximum performance without sacrificing accuracy. The spectrometer accepts an SMA905 fiber-optic input that can be connected to a wide variety of optics, including integrating spheres for total flux measurements or CIE127 Conditions A and B for intensity measurements. Custom configurations and application support are also available for OEM applications.

The RadOMA Lite features an 800 kHz readout speed and slit options that can achieve resolutions between 0.5 nm and 3.0 nm. The custom RadOMA-Lite Windows software package for LEDs includes a simple, intuitive interface with automated report generation and a USB 2.0 interface.

**Proven Technology and Performance:**

Gamma Scientific's RadOMA series platform is a durable opto-electrical design proven in hundreds of facilities worldwide. RadOMA spectroradiometers combine the leading-edge sensitivity of a backside-thinned CCD detector with Gamma Scientific's industry renowned OMA optical multi-channel analyzer platform for unmatched speed and performance, ideal for multiple applications, including LED color and luminance testing, flat panel display measurement, reflectance, transmittance and light source measurement. ■

## Instrument Systems Announces New Products for 2012

Instrument Systems launches new products for LED measurement and testing. The CAS 120 is a new series of the proven CCD array spectrometers, specifically developed for price-sensitive applications in spectral light measurement, such as LED production testing. A new, own current source for LED testing is the LSM 350 4-quadrant source, developed to meet the requirements for production testing of LEDs and LED wafers.



**The new Instrument Systems solution for LED tester (left), the LSM 350 basic module in bench enclosure (right, top), and the CAS 120 CCD array spectrometer (right, bottom)**

**Main Features:**

- As a bipolar current and voltage source, the LSM 350 offers all functions necessary for testing LEDs fast.
- The automatic polarity test feature can be used for single and multi-chip LEDs.
- Dedicated measurement ranges permit particularly precise testing at low forward currents of 1  $\mu$ A, and measurement of reverse currents in the nA range.
- The modular concept includes an option to measure breakdown voltages up to 40 V.
- Very short settling times reduce the test cycles by up to 40% compared to those of most standard current sources.

**New System solution for Production Tests with LEDs and LED Wafers:**

The LSM 350 4-quadrant source and measure unit from Instrument Systems was specifically developed to meet the requirements for production testing of LEDs and LED wafers. High test speeds and the multichannel capability make the LSM 350 an attractive solution for supplying current or voltage to LEDs with low to medium power output. Combination with Instrument Systems' array spectrometers creates a complete solution for optical and electrical testing carried out on LEDs.

### Powerful Spectroradiometer for QC and Production:

Instrument Systems launches the CAS 120 as a new series of the proven CCD Array Spectrometers. This measuring instrument was specifically developed for price-sensitive applications in spectral light measurement, such as LED production testing or quality assurance. Although costs have been reduced, technical innovations deliver even higher levels of reliability and robustness.

#### Key Features:

- Proven optical design combines with innovative technology:  
A Crossed Czerny Turner Spectrograph with back-illuminated CCD detector forms the core of the spectrometer. This means that the CAS 120 guarantees exceptionally low stray light and a very high level of optical precision. The temperature of the CCD detector is recorded each time a spectrum is measured, and an innovative algorithm automatically corrects the signal.
- The newly developed filter wheel with density filters OD 1 to OD 4 comes without any mechanical position switches and always guarantees exact filter positions.
- Instrument Systems supplies a DLL and a LabVIEW® driver for use in production environments and at automated measurement stations. SpecWin Pro and SpecWin Light spectral software packages have been developed for a wide range of lab applications with functions for analysis and documentation of test results. ■

## AvaSpec-RS Series - the World's Most Configurable Microspectrometer

Until now the miniature spectrometer technology has not really supported customer demands for flexibility and configurability. Now Avantes launches the world's first miniature spectrometer with an exchangeable slit. Available in April, this spectrometer makes you choose the right selection between throughput and resolution, every time you need to.

The Avabench-RS is a microspectrometer that is adaptable to your changing needs: whether you need higher throughput or higher resolution.



**Avantes' world's first Miniature Spectrometer with an exchangeable slit will be available in April**

In your laboratory, on the road: it only takes a screw driver to continue your measurements with a new set-up.

The Avabench-RS optical bench is the enabling technology for this technological advancement and is now available in all Avantes UV/VIS/NIR AvaSpec spectrometers. Based on our Ultra Low Stray light optical bench, this means you will get up to 5 times better stray light performance and exceptional thermal and mechanical stability.

The AvaSpec-RS series spectrometers are available with all the options the original models have: an extensive line up of different gratings, a wide choice of detectors, order sorting filters and collimating lenses. ■

## GPD Global's PCD4H Dispense Pump Improves Yields for LED Manufacturers

GPD Global, a precision fluid dispensing systems manufacturer for high-volume 24/7, low-volume / high-mix and R&D production, announces that its PCD4H Dispense Pump yields excellent results with phosphor and non-phosphor-filled LED encapsulation.

**GPD Global's new PCD4H is perfectly designed to produce phosphor and non-phosphor-filled LED encapsulation**

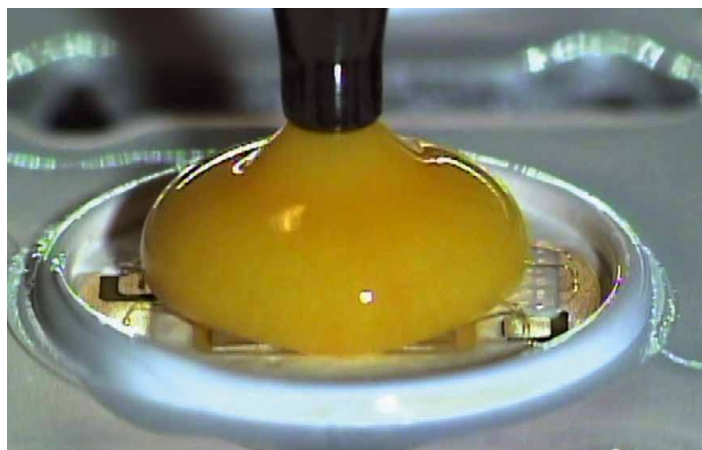

When dispensing a phosphor-filled encapsulant, the PCD4H is configured with a syringe mixer to keep the encapsulant homogeneous over its entire pot life. The adjustable speed of the syringe mixer and a rotating element designed to create turbulence ensures encapsulant homogeneity. Repeatability of volumetric dispense is not affected by varying levels of fluid in the syringe or the change in viscosity over the pot life. Additionally, repeated calibration is not required during the pot life to maintain volumetric consistency. PCD4H is a continuously volumetric dispense pump that is not limited to a certain volume and does not require trial-and-error setup to reach a desired volume. One pump is able to dispense a full range of device sizes without any changeover.

Air-free syringe changeover is made possible with ergonomically placed bleed ports, eliminating the need to purge to remove trapped air bubbles. Additionally, using GPD S Type Taper Tips will improve dispense performance by minimizing fluid pressure at the dispense tip and enhancing fluid flow. No drip or drool is present after the dispense process. The PCD4H has high flow rates and outstanding repeatability to improve yields for LED manufacturers.

PCD4 and PCD4H pumps are available on GPD Global Max, DS and Island Series robots. ■



We bring quality to light.



Putting LEDs in the right light.

SSL solutions from the world leader in LED measurement



**NEW:** LGS 250  
Goniophotometer

Instrument Systems set the benchmark in LED testing with high-performance spectroradiometers for photometric and colorimetric measurements. Now we present another breakthrough in Solid-State Lighting with our new goniophotometers and integrating spheres.

[www.instrumentsystems.com/ssl](http://www.instrumentsystems.com/ssl)

Come and see us at  
**LIGHT + BUILDING 2012**

Frankfurt, Germany, April 15 - 20, 2012  
Hall 4.1 Booth No. K89

 **Instrument  
Systems**  
light measurement

## Success in Research: First Gallium-Nitride LED Chips on Silicon in Pilot Stage

Researchers at Osram Opto Semiconductors have succeeded in manufacturing high performance prototypes of blue and white LEDs, in which the light-emitting gallium-nitride layers are grown on silicon wafers with a diameter of 150 millimeters. The silicon replaces the sapphire commonly used until now without a loss in quality. Already in the pilot stage, the new LED chips are to be tested under practical conditions, meaning that the first LEDs on silicon from Osram Opto Semiconductors could hit the market in just two years.

“Our investments in years of research are paying off, because we have succeeded in optimizing the quality of the gallium-nitride layers on the silicon substrates to the point where efficiency and brightness have reached competitive market levels. Stress tests demonstrate the high quality and durability of the LEDs,” says Dr. Peter Stauss, project manager at OSRAM Opto Semiconductors. The company has acquired comprehensive expertise over the last 30 years in the process of artificial crystal growth (epitaxy), the foundation for this milestone in the development of new manufacturing technologies. The German Federal Ministry of Education and Research funds these activities as part of its “GaNonSi” project network.

On account of the availability of large wafer diameters and its very good thermal properties, silicon is an attractive and low-cost option for the lighting markets of the future. The blue UX:3 chips in the standard

Golden Dragon Plus package achieve a record brightness of 634 mW at 3.15 volts, equivalent to 58% efficiency. - Outstanding values for 1 mm<sup>2</sup> chips at 350 mA. As white LEDs, these prototypes correspond to 140 lm at 350 mA with an efficiency of 127 lm/W at 4500 K. ■

## Removing Impurities from QDs may Lead to Affordable QD-Products

A team of researchers led by chemist Paul Alivisatos, director of Berkeley Lab, and Prashant Jain, a chemist now with the University of Illinois, has discovered why nanocrystals made from multiple components in solution via the exchange of cations (positive ions) have been poor light emitters. The problem, they found, stems from impurities in the final product. The team also demonstrated that these impurities can be removed through heat.

“By heating these nanocrystals to 100 degrees Celsius, we were able to remove the impurities and increase their luminescence by 400-fold within 30 hours,” says Jain, a member of Alivisatos’ research group when this work was done. “When the impurities were removed the optoelectronic properties of nanocrystals made through cation-exchange were comparable in quality to dots and nanorods conventionally synthesized.”

Says Alivisatos, “With our new findings, the cation-exchange technique really becomes a method that can be widely used to make novel high optoelectronic grade nanocrystals.”

Jain is the lead author and Alivisatos the corresponding author of a paper describing this work in the journal *Angewandte Chemie* titled “Highly Luminescent Nanocrystals From Removal of Impurity Atoms Residual From Ion Exchange Synthesis.” Other authors were Brandon Beberwyck, Lam-Kiu Fong and Mark Polking.

“While holding promise for the simple and inexpensive fabrication of multicomponent nanocrystals, the cation-exchange technique has yielded quantum dots and nanorods that perform poorly in optical and electronic devices,” says Alivisatos, a world authority on nanocrystal synthesis who holds a joint appointment with the University of California (UC) Berkeley, where he is the Larry and Diane Bock professor of Nanotechnology.

As Jain tells the story, he was in the process of disposing of CdSe/CdS nanocrystals in solution that were six months old when out of habit he tested the nanocrystals under ultraviolet light. To his surprise he observed significant luminescence. Subsequent spectral measurements and comparing the new data to the old showed that the luminescence of the nanocrystals had increased by at least sevenfold.

“It was an accidental finding and very exciting,” Jain says, “but since no one wants to wait six months for their samples to become high quality I decided to heat the nanocrystals to speed up whatever process was causing their luminescence to increase.”

Jain and the team suspected and subsequent study confirmed that impurities – original cations that end up being left behind in the crystal lattice during the exchange process – were the culprit.

The shutting off impurity-mediated trapping should also boost other optoelectronic properties in nanocrystals synthesized via the cation-exchange technique. ■

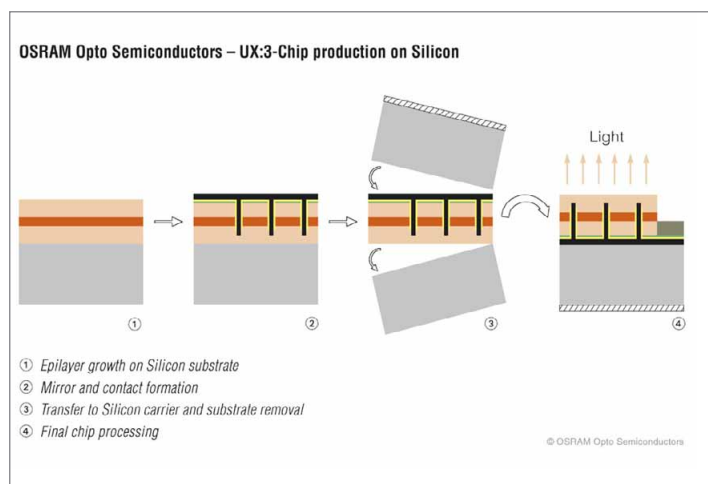

**The process diagram shows the production of a UX:3 chip on a silicon wafer**

**Luminescence of CdSe/CuS nanocrystals prepared by cation-exchange. Prior to purification (left), and the same nanocrystals after purification (right) (courtesy of Lawrence Berkeley National Laboratory)**



THIS IS NOT AN LED —  
THIS IS LIGHTYEARS AHEAD.



The new Acrich2 boards are the perfect LED solution for the replacement of conventional light bulbs. Characterised by their long life and low energy consumption, they can be connected directly to alternating current. With an output of 4 W to 16 W they can also replace MR16 halogen lamps and recessed spotlights in addition to light bulbs.

Further properties:

Energy efficiency higher than 90%, power factor greater than 0.95, THD less than 25%, dimmable, no noticeable flickering.

Visit us at Light+Building  
2012, hall 4.2 J70

**Better Be Bright.**  
[www.betterbebright.com](http://www.betterbebright.com)



# Light+Building Highlights - Exhibits Focus on Energy Efficiency and Versatility

Siegfried Luger and Arno Grabher-Meyer from LED professional were present at the Light+Building PreView in Munich and got a first impression of the L+B highlights from several leading companies in the industry. They talked with company representatives about their expectations and market estimations, and discovered what some of the trends will be at L+B 2012.

**Figure 1:** Osram's new Parathom Classic A75 provides real incandescent irradiation characteristics combined with smooth dimmability

When the Light+Building trade fair opens its gates on April 15, 2012, Philip Rösler, the German minister for economic affairs will highlight the significance of "green" technologies on display for politics as well as for the entire economy. After all, the main topic for many of the more than 2,100 exhibitors and the 180,000 visitors expected is energy efficiency and the smart use of energy in lighting and building. This focus corresponds to the trade fair's special show titled "Buildings as Power Plants in the Smart Grid". The show is located on the open-air exhibition ground between halls eight, nine and eleven and demonstrates through live installations how future-oriented energy management works and what it achieves.

While these installations focus on energy generation and smart distribution, they also include energy efficient lighting concepts with LED lighting, in this context, being the most promising technology. The reason is that the energy consumption of buildings accounts for 40 percent of the world's total energy consumption and thus buildings offer a very high potential for energy savings. According to calculations conducted by the German electrical industry association



ZVEI, the deployment of energy efficient lighting technologies would yield energy savings of up to 20 terawatt-hours per year, the equivalent of seven power plants of the 400 MW class - in Germany alone. Or, to think one step further into the future, buildings could be converged from energy sinks to energy sources and energy stores. One of the key technologies towards this end is digitalization of lighting and building technology as a whole.

Osram, as one of the largest exhibitors in the lighting segment, comes to the fair with a broad range of new LED-based designs. Also, the company plans the Light+Building

debut of the building control technology acquired through the takeover of US-based software company Encelium.

Against the background of the technology change in the lighting market where solid-state lighting increasingly gains market share, LED-based lighting devices take center stage in Osram's booth in hall 2.0. For instance, the company displays the Parathom Classic A75, Osram's first direct replacement product for 75 W incandescent bulbs. For many customers, replacing existing light bulbs by modern LED light sources in the same socket is the simplest way to enter the LED lighting technology.

According to a McKinsey study, sales of such retrofits are expected to triple (by units) during the next five years. By the end of the current decade, LED-based retrofits will have a larger market share than today's most popular energy saving lamp technology, the CCFL. For its Parathom Classic A75, Osram promises energy savings of almost 400 Euros during the lamp's service life.

The fast pace of technology change requires a new luminaire design for almost every new LED generation. An answer to this challenge is standardized LED modules which are comprised of several LEDs and which can be connected in various ways. In order to make modules compatible, 170 stakeholders in the lighting market have united in the Zhaga consortium which defines interface specs for these modules and related control electronics. Definitions include mechanical, electrical, thermal and photometrical aspects. The goal is to create a standardized infrastructure environment for LED-based light engines, much like the standard dimensions and screw-in sockets of today's incandescent light bulbs. Such a standardization process is regarded as one of the most important preconditions for widespread acceptance of LED-based lighting technologies.

At the Light + Building event, Osram will present its first Zhaga-certified light engine. A circular LED module named Prevaled Core Z2. Designed for spotlight and downlight applications, the Prevaled Core Z2 offers a lighting efficiency of 108 lm/W, roughly ten times better than an incandescent bulb. Besides the circular Core Z2, Osram will also show the bar-shaped modules, Prevaled Linear and Prevaled Linear Slim, for office and industrial building lighting applications.

Another example that demonstrates the edge of LED modules over firmly attached LEDs is the Streetlight10 LED from Osram subsidiary Siteco. Since the luminaire and module are separated, modules for various applications can be integrated within one luminaire. This approach helps to reduce costs associated with development and manufacturing. With the Streetlight10, Osram targets the market for communal outdoor lighting.

With its Encelium light management system, Osram demonstrates how to reduce up to 75 percent of the energy required for lighting in offices, industrial and commercial buildings. The system allows users to apply and combine six different power saving strategies. Users can monitor and control lighting status; a 3D-view on the computer monitor gives an instant overview over the situation in real-time. In addition, the software identifies optimization potential and enables building operators to benefit from flexible energy tariffs.

Another industry giant exhibiting at Light+Building is General Electric (GE). For the first time, the company plans to put the focus of its exhibits on energy efficient lighting systems. One of the highlights at the GE booth will be the Lumination luminaire product line, designed to replace traditional T8 and T5 office lighting products. According to GE, the output matches that of linear fluorescent products, with up to 40% energy savings - and due to the controlled lighting distribution, fewer fittings are required in most cases.

With its Infusion LED Module, now in the second generation, the company plans to attract shop lighting designers. The module is ideal for track/accent lighting as well as for downlight applications. It gives designers



## Edge Lighting Technology for Superior Illumination

### Custom Downlight Assemblies



### Range of Color Temperatures



### Custom Molded Lighting



### Directional Lighting



+1-440-922-4584 • [info@glthome.com](mailto:info@glthome.com)  
[www.glthome.com](http://www.glthome.com)

See GLT at Light+Building,  
Hall 10.1, Booth B11H &  
LightFair International, Booth 5148

**Figure 2:**  
GE's second generation of the proven Infusion LED Module will once more draw attention from the crowds at L+B 2012



the freedom to create dramatic and attention-grabbing displays with the flexibility to vary color temperatures and beam angles just by swapping modules. Other exhibits for shop illuminations include the Tetra A10 linear system which offers a remarkable high CRI of 93, and the LED Cove Lighting System that operates at higher lumens and fewer watts than xenon or cold cathode systems. The Immersion RV40 LED

system is said to provide excellent light distribution for enhanced visual appeal for just 25% of the running cost of traditional T8 fluorescents.

The outdoor product range at display at GE's Light + Building booth includes the latest generation of LED Area Lighter luminaires for car parks, pedestrian zones or for general illumination. The new modular design provides 58 photometric combinations

available in two color temperatures - 4,000 K and 5,700 K, both with a CRI of 70. The new LED Road R250 luminaires offer an advanced optical system that improves the uniformity of both vertical and horizontal light, enabling better control and superior obstacle detection. At the same time, the high chromatic reproduction affords visual comfort and facial recognition for both drivers and pedestrians, enhancing security and safety for a wide range of applications.

Philips is another major player in the lighting industry that shows its achievements in Frankfurt. Like competitors GE and Osram, the company exhibits LED lamps and modules for a very broad range of application fields, from home illumination to street lighting and lighting concepts for commercial buildings.



**Figure 4:** Philips also displays a 75 W version of its Ambilight replacement bulbs

Philips' GentleSpace surface area luminaire is the first LED-based solution for commercial buildings that can directly replace conventional HID installations without rewiring at power

**Figure 3:**  
The Spar Hotel of the Bygg-Gota Group is one of the first hotels that installed the DimTone GU10 MASTER LED and benefits from the new technology



# HIGH COLOUR RENDERING INDEX



[IC]

[OPTO]

[LED]

[LCD]

[RF]

Sharp has extended its LED portfolio to include three high-luminosity modules: the 15W, 25W and 50W MegaZENI LEDs. These LED arrays are compact, light and extremely bright with a shinningly high light quality. Sharp's MegaZENI LEDs give product developers and designers the chance to achieve the best possible colour reproduction in surroundings where ultra-high luminance is essential, e.g. spotlights or downlights. These new arrays stand out from the crowd with a luminous flux of up to 6,700 lm, a luminous efficacy of up to 105 lm/W, a CRI of up to 93 and a lifetime of up to 40,000 hours at an operating

temperature of up to 90 °C. Such qualities mean they are not just the intelligent alternative to individual LEDs but also first choice for indoor and outdoor lighting applications. MegaZENI LEDs are Energy Star and ANSI-compliant, combine maximum energy efficiency with minimum thermal dissipation, and come in various colour temperatures from warm to cool white.

**Our Service Team will be glad to supply you with any engineering samples and advice you need. E-Mail: [info.sme@sharp.eu](mailto:info.sme@sharp.eu); Phone: +49 (0)180 507 35 07; [www.sharpleds.eu](http://www.sharpleds.eu)**

**light+building**

Visit us at the Light+Building 2012  
from 15–20 April in Frankfurt am Main: Hall 4.2, Booth J71.

**SHARP**

| Microelectronics

levels of up to 400 W. According to Philips, energy savings resulting from the change amount up to 40%. The service life stands out with 90,000 hrs, minimizing maintenance efforts. GentleSpace luminaires are equipped with a DALI interface, enabling users to integrate them into a smart lighting control system.

For home applications Philips shows its DimTone technology: It does not only change the brightness of an LED when dimmed, but also the light color, much like a conventional light bulb and creating a very decent, pleasant candle light atmosphere. With a new luminaire equipped with the DimTone technology, Philips expands its Ledino product range. The 7 W GU10 MASTER LED luminaire with DimTone boasts a maximum light intensity of 1,100 cd. During dimming, color temperature changes from 2,200 K to 2,700 K.

Of course, an LED-based replacement for 75 W incandescent lamps is also on display at the Philips booth. While it offers a luminous flux of 1,050 lm, its power consumption is only 17 W, 80% less than the conventional type it has been designed to replace.

Toshiba New Lighting Systems brings its range of LED lamps, LED light engines, downlights with replaceable LED engines and outdoor lighting products to the fair. The company's outdoor lighting product program takes center stage, with the E-Core LED Weatherproof and the ENROAD road light being of particular interest. The common denominator is the constant light flux over the entire service life, controlled by a closed control loop in the driver. This feature increases the current through the LED over time to compensate for the decreasing light intensity. At the beginning of its service life, the 9000 lm lamp consumes 103 W; as the light flux decreases through aging effects, the current is increased to keep the light flux level constant. This effect causes the electric power consumption to increase over time; at the end of the service life, the same lamp consumes 145 W. Thus, users and operators can detect that a lamp is approaching the end of its service life and take appropriate measures.

Another feature of Toshiba's outdoor lighting products is that it disposes of an integrated two-way driver circuit which helps to improve its reliability - if one LED or driver within a unit fails for whatever reason, the other unit maintains a reduced brightness level. This driver also offers a soft start function which has been designed with road safety in mind: When switched on, full brightness is reached gradually over a time span of 5 seconds. This helps to avoid distraction for car drivers underway on the street.

At the Light + Building, Toshiba will highlight two new products - the E-Core LED Weatherproof and the ENROAD road light. The E-Core LED Weatherproof has been designed for operation on extreme ambient conditions outside and inside of buildings - car parks, warehouses and even refrigerated warehouses, for example. This lamp offers a light flux of about 1750 lm, an efficiency of up to 82.7 lm/W and a service life of 40,000 hours. Protected against dust and water according to International Protection Rating IP65, the lamp is available in two variants - one with a polycarbonate hood is particularly impact resistant and even withstands hammer attacks according to IK08 specifications.

The ENROAD street lamp offers 9000 lumen at a color temperature of 5000 K. Light distribution characteristics are designed to evenly illuminate streets, sidewalks and footpaths. The lamp is designed for an installation height of ten meters.

It meets the requirements of DIN EN 13201 for the illumination of public roads. With a service life of 60,000 hours it helps operators to reduce maintenance costs.

Trilux showcases its Coriflex digital lighting system. It excels through small dimensions for its compact LED modules. With its elaborate mechanical concept it can save up to 50 percent of the time required for installation, the company claims. All components such as supporting rail, attachment carrier and reflectors are integrated in this "all-in-one" solution. A broad range of optics and lighting colors is available, translating into unseen application flexibility.

With the Aurista, Trilux sets a design highlight to replace conventional wide spread lamellae louvre recessed luminaires. The new developed design allows various configurations and provides a virtually glare-free light.

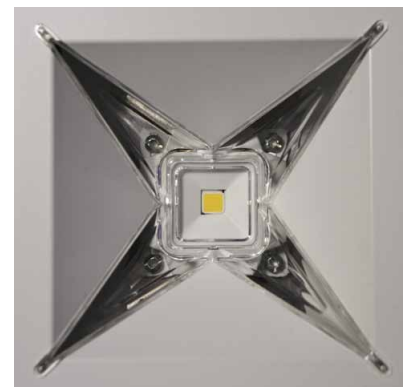

**Figure 6: The Aurista may contain up to 9 of these lighting elements in the 60 x 60 cm recessed format**



**Figure 5: Toshiba's new ENROAD LED lighting concept offers several very useful features to the customer, like the lifetime dependent current regulation - just to name one**





**light+building**

15.–20.4.2012

Hall **3.1**

Stand **C11**

## **Channel Office C-LED**

Adapts to your planning. Not vice versa.

Illuminate offices according to your plans. The new Channel Office C-LED with LED and micro prismatic lens meets all current office standard specifications according to EN 12464-1. Seamlessly, without shadows, without glare. Come to our stand and see for yourself!

[www.regent.ch](http://www.regent.ch)

 **REGENT**  
Lighting

**Figure 7:**  
Simple to apply,  
cost efficient and  
durable. These are  
the main attributes  
for the weather-  
proof Nextrema  
LED luminary



**Figure 8:**  
ETTLIN's unique  
tissue transforms  
LED light into an  
artwork of light

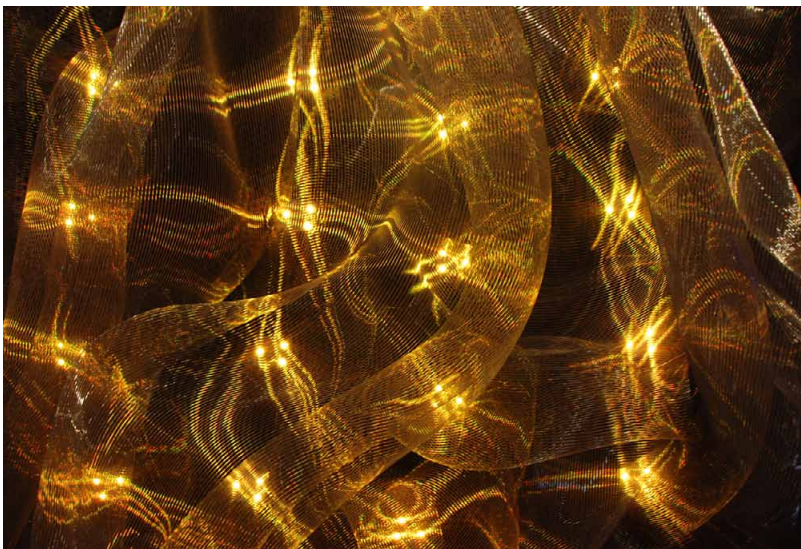

**Figure 9:**  
One application  
of ETTLIN's tissue  
is the lux Smart  
Glass, intended for  
architectural and  
decorative lighting  
installations

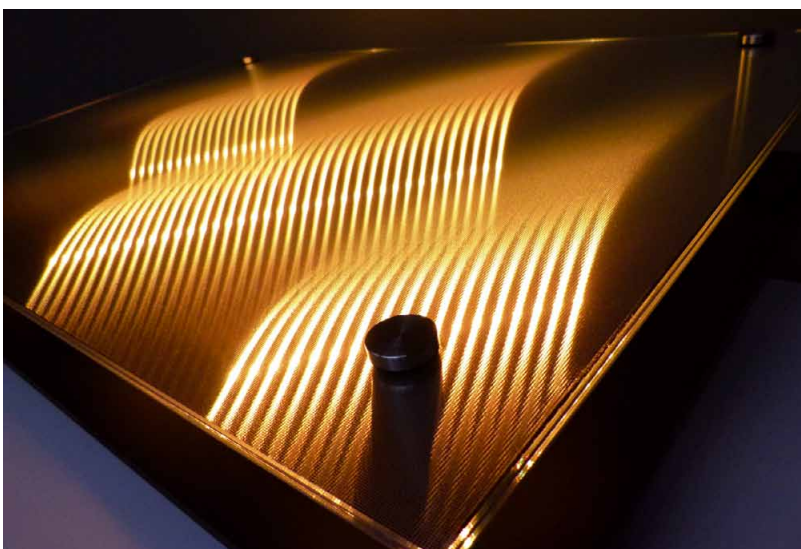

With its moisture-proof Nextrema LED luminaire, Trilux addresses the demand of applications in rough environments. Protected against moisture and dust according to IP66, the LED lamp can be used in cooling

chambers, car parks, and industrial facilities. Despite its compact dimensions of 1 meter, the lamp achieves the same intensity of 4000 lm at 73 lm/W as commercially available lamps with a length of 1.50 m.

Optionally, it can be equipped with an RF motion sensor, enabling users to achieve additional savings effects of up to 35%.

ETTLIN AG comes to the fairgrounds with a very specific technology. A company with a long tradition in weaving and spinning technology, ETTLIN has developed something it calls ETTLIN lux - a tissue that creates three-dimensional light structures when combined with LED lighting. Now the ETTLIN engineers have combined this tissue with the surface optic of sophisticated glass; the technology will be shown to the public for the first time at Light + Building. The 3D light effects are realized by embedding the tissue into a compound glass. If LED light passes through this structure, a variety of lighting bodies and patterns are created, depending on material, arrangement, distance and viewing angle. The light structures generate a strong spatial impression with a depth effect that goes beyond the dimensions of the structure.

Potential applications for ETTLIN lux Smart Glass can be found in architecture and art. It can be used for large-area decorative light installations, as an optical privacy shield, or for sophisticated surfaces in furniture. The illumination creates a representative atmosphere in bars, restaurants of hotels as well as in shops and showrooms. The transparent and translucent properties of the material can be controlled through adding and removing parts of the illumination or by dimming. Through the usage of LEDs, it is possible to create dynamic color changing effects and varying ambiances.

All in all, there are some common denominators in LED lighting that can clearly be identified - energy efficiency, light quality and intelligent controls. Furthermore, modularization with proprietary and standardized form factors can be identified as a future trend. It will be very interesting to see how all these parts play together. In Frankfurt, the trade fair visitors can experience it all. ■

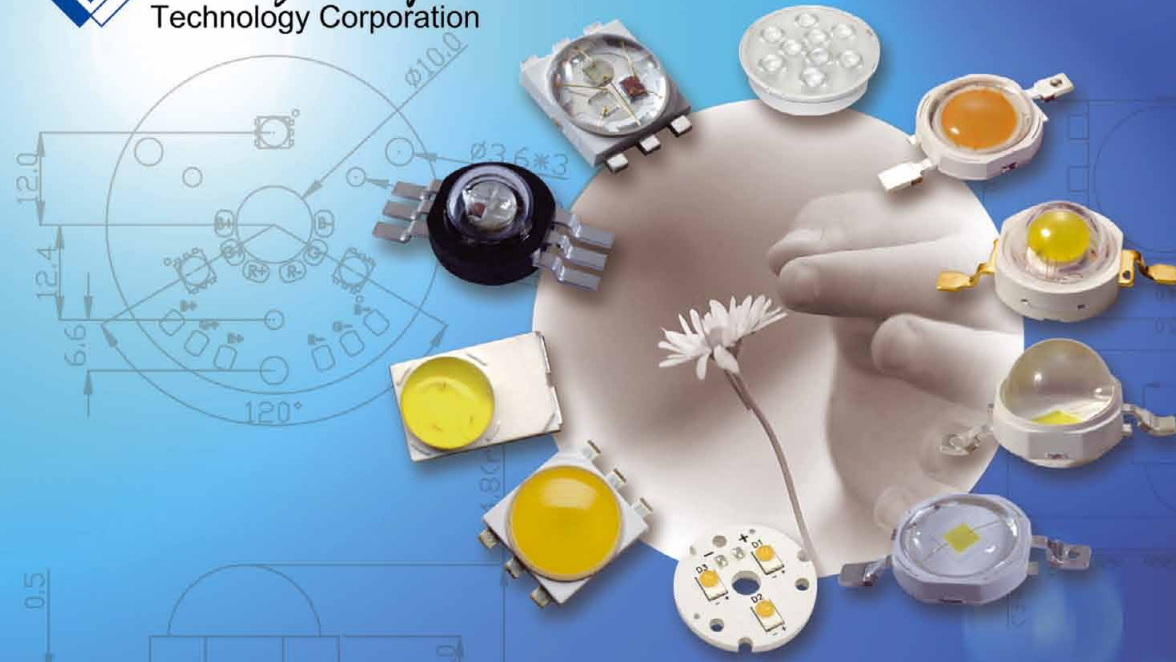

*Exclusive Made in Taiwan*

**Professional High Power LED Makers**

No. 89, Xiyuan Rd., Zhongli City, Taoyuan County 320, Taiwan (R.O.C)

TEL: +886-3-461-8618

FAX: +886-3-461-8677

E-mail: sales@prolightopto.com

http://www.prolightopto.com

**PROTECT-R-SHIELD**

# The Optically Clear Conformal Coating

Protects LED and Printed  
Circuit Boards from  
Environmental Damage

MOISTURE • DUST • SALT SPRAY • CORROSION

Let PRS Be Your Solution Provider

- Lifetime, non-yellowing conformal coating
- Negligible lumen loss when coated over LEDs
- Patent-pending optical lens attachment
- Low to high volume production - let us quote



**protect-r-shield®**

www.protectrshield.com • tel: (888) 257-4780

computer-controlled robotic  
selective dispensing  
**the Precision Conformal Coating**

# LED Technology – Changing the Component Business in the Area of Lighting

In an interview with LED professional, Volker Neu, the General Manager of LED at Vossloh-Schwabe Optoelectronic explains the influence LED technology has on the component business in the area of lighting. Internal and external changes and alterations are necessary to be able to adjust to new technologies. Innovations and standards are especially important for moving the business of LED solutions forward.

**LED professional:** What solutions, in general, does VS Optoelectronic offer to the lighting market?

**V. Neu:** We are a manufacturer of standard products in the area of light sources which we offer to lamp manufacturers and specialist retailers. In addition, we produce drivers and controller parts and in the area of accessories and solutions, we offer the development of lenses and complete solutions. Besides the component business, in the area of Customer+Application, we also offer our clients support during implementation.

**LED professional:** What percentage of Vossloh-Schwabe's business lies in the area of LEDs?

**V. Neu:** Basically, we are divided into two companies; Vossloh-Schwabe Optoelectronic and Vossloh Schwabe GmbH. The total percentage of LED business is still small whereby the plan is to make a big switch over the next few years. Our parent company, Panasonic in Japan, has been establishing its competencies in the area of LEDs for years and we can use this know-how to prepare for the market launch of LEDs.

**LED professional:** Your parent company, Panasonic, produces LEDs itself, yet you use LEDs from other manufacturers as well, like for example, Cree.

**V. Neu:** We are a distributor for Cree and Nichia. They are both strong partners that we need in order to have second sources in the background. Panasonic in Japan doesn't actually produce LED chips, but rather, has gained a lot of expertise in the area of processing, like in COB technology.

**LED professional:** How has the emergence of LED technology changed the component business in your company?

**V. Neu:** We had to change our business completely. Don't forget that with the LED you have a component that allows the parameters to exactly describe physical elements like wave length, color temperature or efficiency. On the other side, this element meets with the implementation which is steered by emotions, effects and design. A bridge has to be created between these two worlds. You also have to bring the luminaire manufacturer on board in order to realize new product ideas.

**Figure 1:**  
Vossloh Schwabe's new LED streetlighting module offers maximum flexibility, high efficiency and reliability paired with simplified mounting

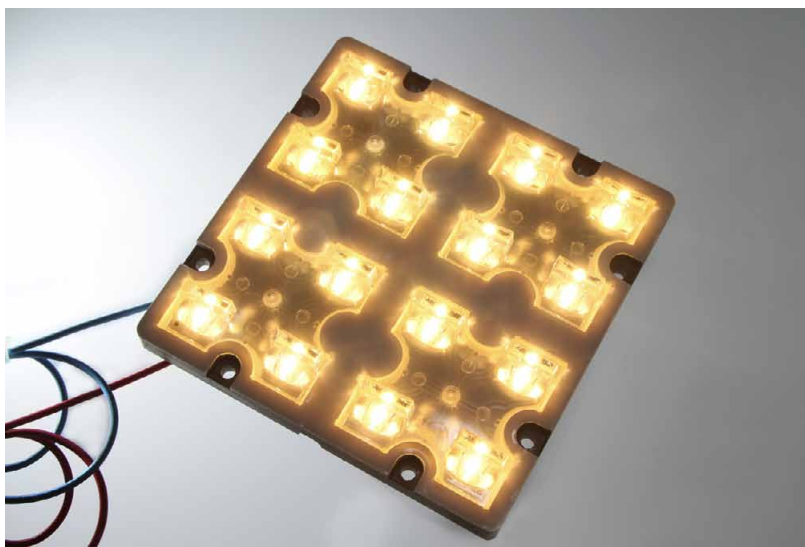

**LED professional:** The market is not always the same. What differences have you seen in relation to requirements in different countries?

**V. Neu:** There are countries where emotions play a much larger role, like in France or Italy. Generally, the southern European market is more design oriented than the middle or northern European market. The Italian market is strong in the area of household appliances and LED solutions have been applied there for years. Italian designs focus mainly on plastic casings instead of aluminium casings which are getting more and more expensive. Ideally then, LED solutions must be adapted to these market conditions.

**LED professional:** The importance of the standardization consortium, Zhaga is increasing. Can you give us some information about the first real work results?

**V. Neu:** Through our parent company, Panasonic, we are actively involved in the definition of the Zhaga standards. There is, for example, a specification for mechanical measurements for a round shop module. The goal is to present the final standard at Light & Building.

**LED professional:** Besides the geometric stipulations, are there also definitions in relation to electric and lighting engineering data?

**V. Neu:** Right now there aren't any stipulations for this data. However, the way the parameters are tested will be agreed upon as well as how these parameters are to be declared. Geometrically, the light emission area will be determined and therefore the interface to the reflectors, whereby the type of light distribution will remain open. Photometrically, the standardization is insufficient, yet today Zhaga makes it possible for luminaire manufacturers to at least be able to change the modules mechanically since the mounting dimensions have been defined.

**LED professional:** Is the standard already accepted and adopted by the market?

**V. Neu:** If we look, for example, at the lighting market in Europe, we see that there are big regional differences in customer behaviour. Let's take the example of street lighting. A lamp manufacturer from Germany wants a standard solution so that he can use components and/or modules from various suppliers. In France, on the other hand, the customer wants to find an individual product solution. I feel that it is important that standardization leads to standard platforms which can be adjusted specifically for the customer.

**LED professional:** Let's go back to supplying the LED modules with electricity. There is a wide variety of voltage levels and modes of operation. What direction is development of the systems taking in the area of controls?

**V. Neu:** The products that we are putting on the market today are mostly power operated components and the world of voltage belongs to the past. The currents here lie at 350mA, 750mA and 1050mA, whereby it is possible for us to construct the module with protective extra low voltage. Depending on the mode of operation there is DC as well as PWM steering, if we are talking about dimming. In order to avoid negative effects through modulation, we naturally try to keep the basic frequency higher than 100 Hz.

# VSS VOSSLOH SCHWABE

We've done our  
homework!

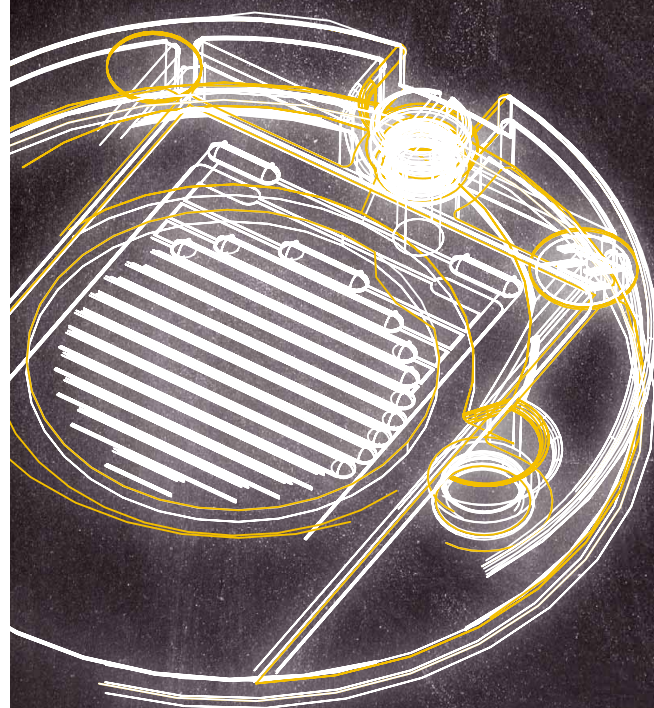

## LED Modules COB Shop

- Long service lifetime: 50,000 h (L90/B10), due to ceramic PCB
- Highly efficient: 106 lm/W at  $t_c = 65^\circ\text{C}$
- Narrow colour tolerance

Visit us: **light+building**  
15. – 20. April 2012, Hall 4.0, Stand B50

[www.vossloh-schwabe.com](http://www.vossloh-schwabe.com)

A member of the Panasonic group **Panasonic**



## Volker Neu

Volker Neu is the director of the competence center LED at Vossloh-Schwabe. After completing his studies as a precision engineer at the II Physical Institute at the University of Cologne, he studied communications engineering with the main focus on emissions from antennas. Following his graduation he worked as a laboratory and development director in leading lamp manufacturers for 16 years. The first big LED project that he was allowed to work on was in 1999 on a vertically adjustable suspension bridge in the inner harbour in Duisburg, Germany. At the age of 44, working as the director of an LED location, he again sees his mission as one of building a bridge. A bridge that will integrate the physical soberness of the purely technical reflection and the emotional view of the design oriented light planner.

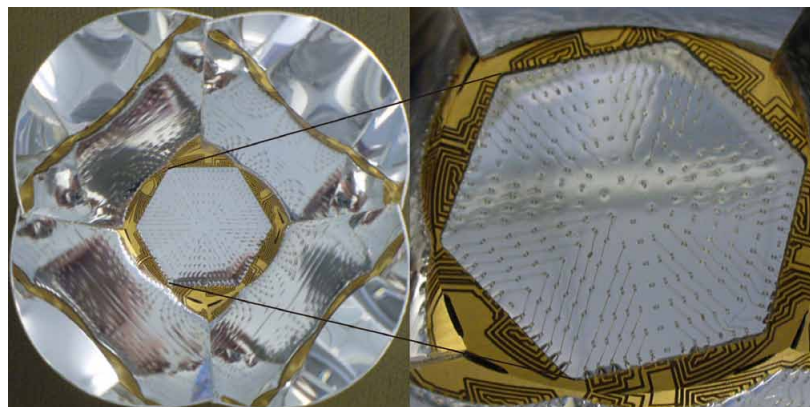

**Figure 2:** One very new approach, the Chip-on-Reflector (COR) technology, can increase efficiency further and allow completely new designs

**LED professional:** What quality standards, or more simply, quality objectives do you have?

**V. Neu:** We offer COB solutions on ceramic substrates and know from the long standing analyses done by Panasonic that contrary to aluminium, there is no chemical interaction with the phosphor. This means that we can guarantee our customers that this technology allows L90 B10 at 50,000 hours. That is an absolute highlight in relation to quality. A fundamental reason for the decrease of light output in COB technology lies in the migration of aluminium into the phosphor. Generally, quality must be comprehensible to the customer and there are very different requirements in regards to implementation and region.

**LED professional:** What new products will Vossloh-Schwabe be showing this year at the Light & Building?

**V. Neu:** There is a new, completely moulded module for street lighting in a die cast housing with a size of 120 mm x 120 mm. This module is very flexible in relation to light distribution, color and CRI. A corresponding 4-fold lens array is incorporated in the grouting

during production. Generally, this module is a modular assembly system which, in turn, should be able to be implemented in indoor applications as well.

In addition, we have developed Chip-on-Reflector (COR) technology where the LED chips can be mounted directly on the reflector. In this way, the reflector is used as a heat-spreader or heatsink. The current system is made up of 294 LED chips with a total operating capacity of 50 W LED output. The LED chip can be set on the reflector, where it is photometrically needed. Each individual chip can be furnished with a specific phosphor where various color temperatures can be used within one reflector. The LEDs can also be hooked up or disconnected individually which makes specific, adaptive and completely new types of light distribution possible from a single luminaire.

**LED professional:** Thank you very much for a very interesting interview, V. Neu, and the best of luck with your new LED concepts.

**V. Neu:** Thank you! ■

# Bringing the Power to Light™ with Simple HBLED Drivers

## High Brightness LED Drivers with High-Side Current Sense

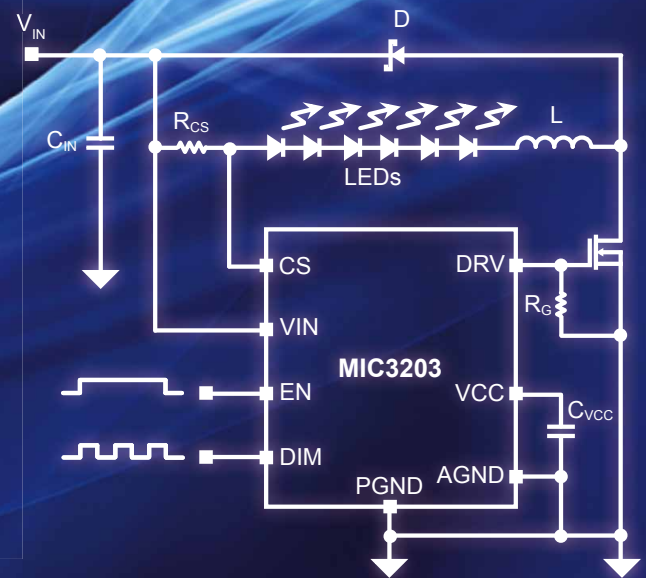
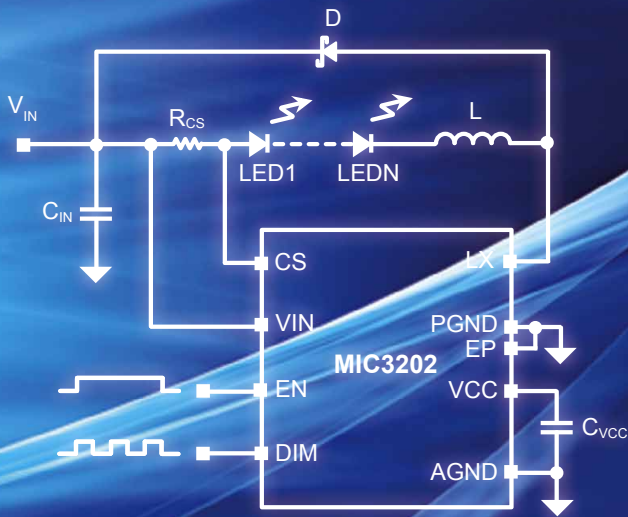

### Applications



The rapid growth of LED lighting applications in commercial, industrial and automotive markets has led to a wide variety of technical challenges for LED Drivers. Micrel is meeting these challenges with simple step-down LED Drivers such as the MIC3202 and MIC3203.

The MIC3202 is a hysteristic step-down LED Driver with integrated MOSFET capable of driving up to 10 HBLEDs with constant currents up to 1A in a thermally enhanced exposed pad SOIC-8L package.

The MIC3203 is a hysteristic step-down LED Driver with an external MOSFET capable of driving up to 10 HBLEDs with power levels up to 40W in a SOIC-8L package.

For more information, contact your local Micrel sales representative or visit Micrel at: [www.micrel.com/ad/leddrivers](http://www.micrel.com/ad/leddrivers).

### Ideal for use in:

- ◆ 12V Lighting Systems (MR-16 Bulb, Under Cabinet Lighting, Garden/Pathway Lighting)
- ◆ Architectural, Industrial, and Ambient Lighting
- ◆ LED Bulbs
- ◆ Indicators and Emergency Lighting
- ◆ Street Lighting
- ◆ Channel Letters

Part Number	Input Voltage	Output Current	PWM Dimming	Dithering	Package
MIC3202	6V to 37V	1A	Yes	Yes	EP SOIC-8L
MIC3202-1	6V to 37V	1A	Yes	No	EP SOIC-8L
MIC3203	4.5V to 42V	Controller	Yes	Yes	SOIC-8L
MIC3203-1	4.5V to 42V	Controller	Yes	No	SOIC-8L



[www.micrel.com](http://www.micrel.com)

# New Approach for a Modular LED COB System up to 500 W

Up until today, the main focus of LED development was to improve efficiency and light quality to become competitive with conventional light sources like HIT or FL lamps. Now the technology is entering a new stage of evolution. Magnus Ahlstedt, Business Development, and Johann Ramchen, Senior manager at Optogan are convinced that products have to be developed in a direction that makes application easier for luminaire manufacturers. Both agree that Optogan's most recent development, the X10, is the answer.

**Figure 1:**  
Modularity on component and application level

Chip on Board Technology (COB) becomes more and more common in general lighting applications. Contrary to the single chip SMD high power component, the chips in a COB are mounted in an array on a single substrate. In analogy with regular LED manufacturing the substrates are then covered with a phosphor film to convert a portion of the blue light. This creates a single component with a relatively high proportion of InGaN chip surface to actual component size.

The advantages of adapting a lighting system to COB technology are many. By avoiding 2nd level PCB integration, the implementation of COB reduces the complexity in the final luminaire manufacturing through an easier mounting procedure and less production steps. This results in lower process related costs. Additionally, to the advantage of its easy utilization, COB's also offer an unpaired thermal and lm/USD efficiency which allows the designer to create high quality and cost efficient LED solutions.

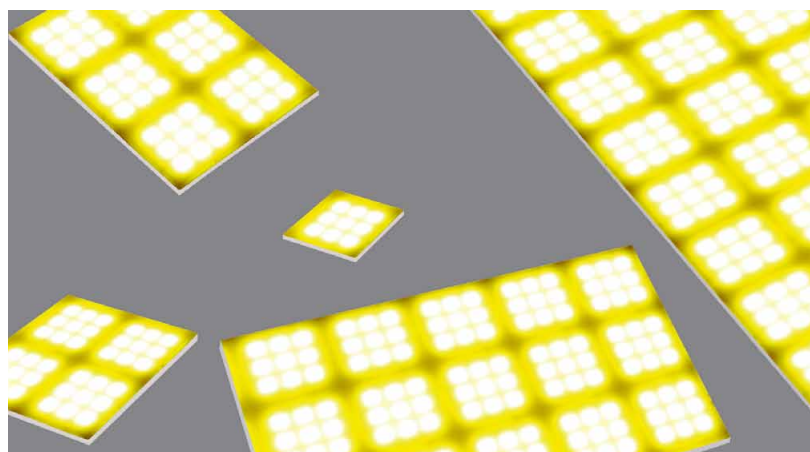

## The Motivation

The rapid industry adoption of the currently emerging COB technologies shows us that the need for simplification is an important trend. The non-unification in the mainstream COBs (in material and mechanical design) makes peripheral infrastructures, such as connector's size dependent, but also augments the logistical complexity for a customer using different power classes. With conventional phosphor deposition techniques, the production's CCT distribution, with its resulting bins, is an obvious problem, not only for the COB users, but also for its manufacturer. A clear trend of the future will be to minimize the bin complexity towards the end user, reducing logistical as well as technical complexity on both sides.

LED manufacturers are going different ways to satisfy these requirements. Optogan has addressed the above mentioned technological deficiencies by focusing on the following keywords: modularity, scalability, logistics and ease of use..

The new platform fulfills the requirement of simplicity and light quality, especially for applications above 100 W. The focus of the development has been to reduce the component complexity from a material, manufacturing and logistical point of view as well as to create a COB platform that is scalable and modular in application level to further enhance the advantages of COB systems for the end user. (2)



**Figure 2:**  
Rationality in  
design – simplicity  
in use

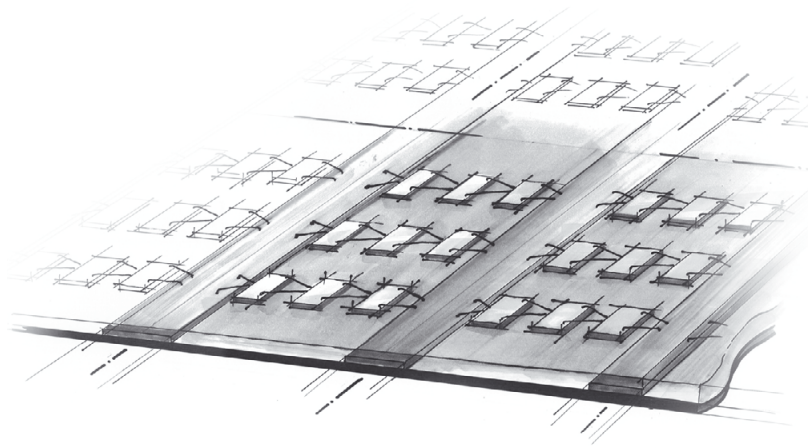

**Figure 3:**  
The universal  
solder free  
connector with  
optics snap in,  
and 2x2 X10 with  
connection: 40 W;  
4,400 lm

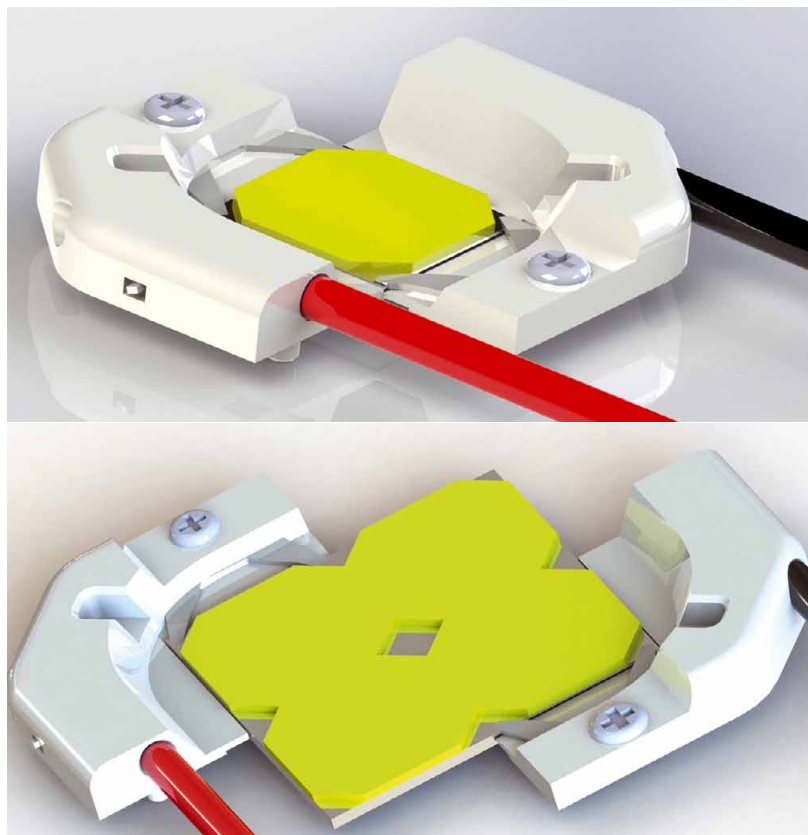

### The Solution

The concept is simple: Generically constructed in a matrix of 5x10, the cells are ceramic based, solder free components, with a unit size of 1 cm<sup>2</sup>. Single modules are connected in serial and parallel strings on a ceramic based substrate. The resulting component: an array of 5 in parallel and 10 in series connected modules that essentially build a single portionable device of 500 W, 5 A @ 100 V. The light output of a single COB element is about 1,100 lm @ 10 W achieving up to 55,000 lm, while driving a COB configuration of 5x10 elements at nominal current.

This modular product allows the user to adopt a unified solution approach for all power classes and brings the manufacturer unification and simplification into the production process. The basic idea is to take the pure concept of the COB array and bring it to component level. Both chip, on component level, and component, on board level, is connected in an array of parallel and serial strings.

The use of a ceramic substrate brings us many advantages in terms of mechanical stability and tolerances but it is also a chemically inert material,

reducing all substrate induced degradation influence on the light quality to a minimum.

By using large chip dies we augment the redundancy of the system and the yield in the production. Additionally, by applying a highly homogeneous converting phosphor layer through a very controllable deposition technique allows us to approach the customer with a “smart binning” - single bin approach. Presuming no design related yield losses, the COBs can be offered in a variety (square, rectangular and linear) of power classes and configurations.

The size of the light emitting area is the same as the device size itself so that it can be regarded as very compact. The COB was designed for direct mounting on heat sinks giving rise to a smaller footprint (including electrical connector) than that of mainstream COB solutions. This advantage was achieved by using an external universal connector and solder free electrical contacts. Together with our partner, a universal connector concept was developed to fit all possible COB module configurations, providing both electrical and mechanical interfaces. Additionally, the connector offers a snap in system for secondary optic attachments and a bidirectional electrical wire insert allowing the connection of COB to COB in series and parallel on application level.

Using highly thermally conductive paste, a good thermal connection to the heat sink can be achieved. Depending on the ceramic material used, a thermal resistance at component level between 2 and 3 K/W (junction to component backside) can be achieved for a single COB unit. By using thermal paste we also let the materials work thermally without mechanically stressing the system. This allows the user to overcome the CTE mismatch between the ceramic component and its heat sink material, even for the largest possible configuration, with the size of 50 x 100 mm.

The versatility of the concept allows integration in different kinds of applications, all the way from high intensity spotlights to high power industrial floodlights. Its cost efficiency therefore also lends it towards integration in the cost sensitive segments.

### Conclusions

The new approach has resulted in a modular COB system unique to the market where simplicity and modularity throughout the value chain have played an important role in the development process. The new platform design can provide COB modules in the range of 10 W – 500 W and can be used with simplicity compared to conventional COB solutions for all different kinds of lighting applications. The modularity of the COB concept has been further extended, together with a simple universal connector system, so that X10 augments the required versatility at the application level. ■

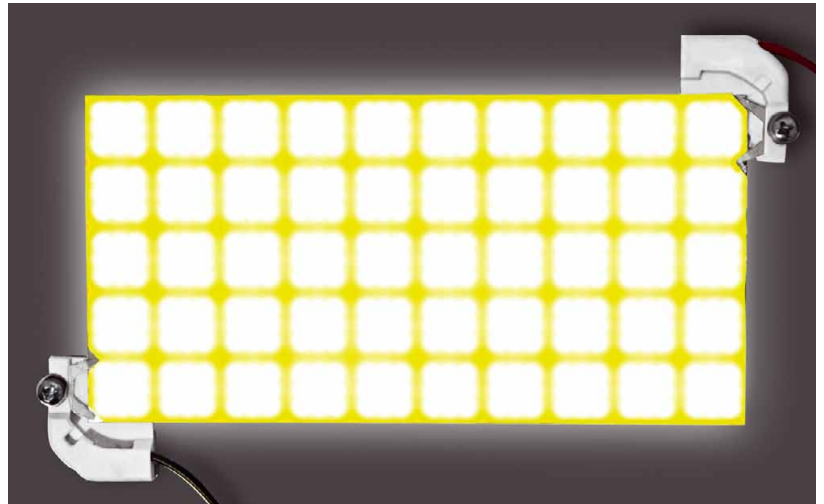

Figure 5: Single 500W X10 COB – 55,000lm



## Accelerate Your Business with China's One-stop LED B2B Platform

- Expand Your Market Share
- Enhance Your Company's Brand
- Extend Your Business Network

ORGANISED BY



# High Efficiency High Voltage High CRI



**EdiPower® II HR**  
9W/ 13W/ 24W/ 35W

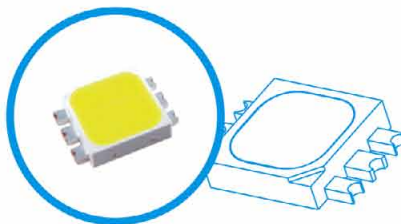

**PLCC 5050 HR**  
1W

**Welcome!**  
2012 Light + Building Frankfurt, Germany  
Date :Apr 15, 2012 - Apr 20, 2012  
Booth :Hall 4.2 E91  
  
2012 LIGHTFAIR INTERNATIONAL, USA  
Date: May 12, 2012 - May 14, 2012  
Booth :201



13W

- Cool White 36V 1400lm 85CRI
- Neutral White 35V 1400lm 85CRI
- Warm White 34V 1400lm 85CRI



1W

- Cool White 18.3V 115lm 85CRI
- Neutral White 18.3V 115lm 85CRI
- Warm White 17.5V 120lm 85CRI

1. LED is a dynamic, creative and evolving technology. Please refer to the datasheets for final specifications. 2. Other colors is available upon request.



4F, No.800, Chung-Cheng Rd., Chung-Ho Dist., New Taipei City, Taiwan 23586  
T+ 886 2 82276996 F+ 886 2 82276997 service@edison-opto.com.tw www.edison-opto.com



www.edison-opto.com

# PCB Design for a High End Stage Light

Emotions are not only transported effectively by music, but also by light. Used as stage lighting, High-Power and High-Brightness LEDs offer numerous possibilities to create effects and atmosphere, says Stefan Hoerth, the Product Manager HSMtec at Haeusermann. A part of the application development team and solely responsible for the subject of LEDs, he doesn't see any problem using common FR4 laminates in those applications.

Constantly growing lighting power resulting in increased thermal stress degrades the reliability and lifetime of the whole LED system. Therefore, their power consumption and their useful life and reliability are dependent on how their temperature can be controlled. Modern High-Power and High-Brightness LED chips can be driven at 1 to 5 W, depending on the chip material and cooling. The light efficiency of these chips is up to 20% to 30 % and more depending on the current, chip material, cooling, etc. Despite the high efficiency of LEDs, approximately 70% to 80 % of the electrical power input is still converted to heat.

Material	Thermal conductivity $\lambda$ [W/mK]
Copper RA	300
Aluminum alloy	150
Solder	51
Ceramic (LED)	24
FR4	0,25
Air (unforced)	0,026

Material	Thermal expansion coeff. X/Y [ppm / K]
Aluminum	24
Solder	≈ 22
Copper	16
FR4	13 – 17
Al <sub>2</sub> O <sub>3</sub> (LED)	7
AlN (LED)	4

**Table 1: Typical material properties of FR4 and MC-PCBs: Compared to aluminium, copper provides twice the thermal conductivity to achieve rapid heat dissipation directly below the LED without any intermediate insulating layers below the LED's heatpad**

## Selecting the Right Thermal Solution

To avoid any damage to the LED's sensitive p/n junction (which should not exceed temperatures above 100° to 120° C due to lifetime and high optical efficiency), excellent heat conduction needs to be taken into account throughout the entire LED assembly. This is usually done via the carrier, substrate and heat sink. If the heat dissipation is not managed correctly, the LED will show chaotic degradation, wavelength shift and loss of radiant flux.

The overall goal is to achieve a low thermal resistance: The better the thermal management design is at removing heat from the system, the more stable the light quality from the LED and optical sub-systems are going to be.

However, the very simple formula of thermal resistance shows only three relevant factors:

- The length L of the thermal element (the shorter the better, or in the case of an LED PCB, the thinner the better).
- The thermal conductivity  $\lambda$  depends on the material and its location in the compound.
- The available cross section A for the heat transfer

The critical bottleneck of the thermal path is the size of the LED as the heat dissipates through this small area.

Therefore, in order to achieve a rapid heat spreading directly below the LED, a high performing material is needed to maximize the cross section. Insulated metal substrates (IMS) where a copper or aluminium substrate is covered with a highly sophisticated isolation material often are the first choice since they ensure low thermal resistance and electrical isolation of the LED chip. Usually in FR4 construction, the PCB is considered to be a bottleneck for thermal management. But is this necessarily true?





## HSMtec – Tailored Thermal Management Solution

A working LED causes a certain operating temperature and when the LED is switched off and/or dimmed the temperature varies accordingly. These slow temperature variations are responsible for a big issue: broken solder joints. This is due to the different linear expansion coefficients of the involved materials which cause mechanical stress. Normally, the components are soldered on a copper/FR4 board and the mechanical stress strains the system and especially the intermediate layers or solder joint. LEDs have a thermal linear expansion of 4 to 8 while aluminium has 23. Indeed, the coefficients for copper and FR4 can both be decreased to 16, but so far it's not possible to eliminate this effect. However, the risk of failure may be lowered significantly.

**Table 2:**  
**Comparison of thermal performance MC-PCBs versus FR4 copper PCBs with embedded copper parts**

Metal-Core-PCBs	Total thickness [mm]	Insulation layer		Temperatur-difference Top - Bottom [K]
		Thermal conductivity [W/mK]	Thickness [µm]	
Standard FR4 insulation layer	1.6	0.25	117	<b>26.6</b>
High-Performance insulation layer	1.6	3.0	38	<b>4.5</b>

FR4-PCBs with embedded copper parts	Total thickness [mm]	Number of microvias	Number of blindholes	Temperatur-difference Top - Bottom [K]
4-layer PCB 	1.2	65	0	<b>5.1</b>
4-layer PCB 	1.2	65	64	<b>2.5</b>
2-layer PCB 	0.8	65	0	<b>1.8</b>
2-layer PCB 	0.8	0	64	<b>1.7</b>

An obviously good choice is Metal-Core printed circuit boards. However, the reliability is not as high as often declared. The result of a shear force test made by Osram Opto Semiconductor showed interesting results: Typical metal core printed circuit boards showed a decrease of the shear force down to less than 20 % of the initial value after being exposed to 1500 thermocycles from -40° to 125°C. Contrary to that, FR4 boards still achieve almost 80 % after 1500 cycles. Shear force tests are used to measure the force which is

needed to peel an LED off a board after a certain number of thermocycles, which is equivalent to the overall reliability of the solder joint. In consequence, the reliability of the whole system (and its lifetime) is also dependent on the choice of PCB and on the materials used.

This printed circuit board technology enables high-current capability and thermal management using FR4 printed circuit boards. Exterior copper components (within the type of wires or profiles) are deposited directly onto

the base copper by means of ultrasonic welding. Copper profiles and wires are connected by etched terminal pads of the inner and/or outer layers of a multilayer printed circuit board. This creates a 100% solid material link between the copper wires and the profiles and the copper surfaces of the rest of the copper conductor layout. At the moment, there are profiles with 0.5 through 12 mm width and variable-length available. Solid current and heat paths can be realised over arbitrary layers of the multilayer printed circuit board with wires and profiles. These copper components from various cross-sections can be variably combined within the same layer.

Fabrication using the standard PCB manufacturing process significantly reduces cost. The extra effort is restricted to a single additional work process. In accordance with the customers' design specifications, the components are located at carefully selected points on the printed circuit boards where there is excessive heat. This means that the copper elements are placed inside the printed circuit board at exactly the place where heat must be dissipated, where large currents circulate, or where the printed circuit boards have to be curved.

LEDs are designed to dissipate heat out of the bottom of the module, while the light is projected out of the top. Typically, LEDs are surface mounted to a printed circuit board. Therefore, the board is the first level of thermal dissipation after the LED chip itself. For many of the low-power LEDs, ordinary FR4 substrates provide acceptable performance. By using HSMtec even High-Power and High-Brightness LEDs could be handled with common FR4 laminates, due to the embedded copper elements. Even though most LEDs already provide an electrically isolated heat pad, current safety regulations often require an adequate electrical isolation of several kV between the LED and the heatsink or housing. As modern High-Brightness LEDs of more than 10 W per package require top thermal performance, the insulation layer of typically used

**Figure 1:**  
**Advanced two layer FR4 board with embedded copper parts (top): Solid copper parts are partially embedded into standard FR4-printed circuit boards to realize rapid heat dissipation within the PCB and sophisticated thermal management concepts for highest demands. The design below can handle up to 200 watts of LED power on a single board**

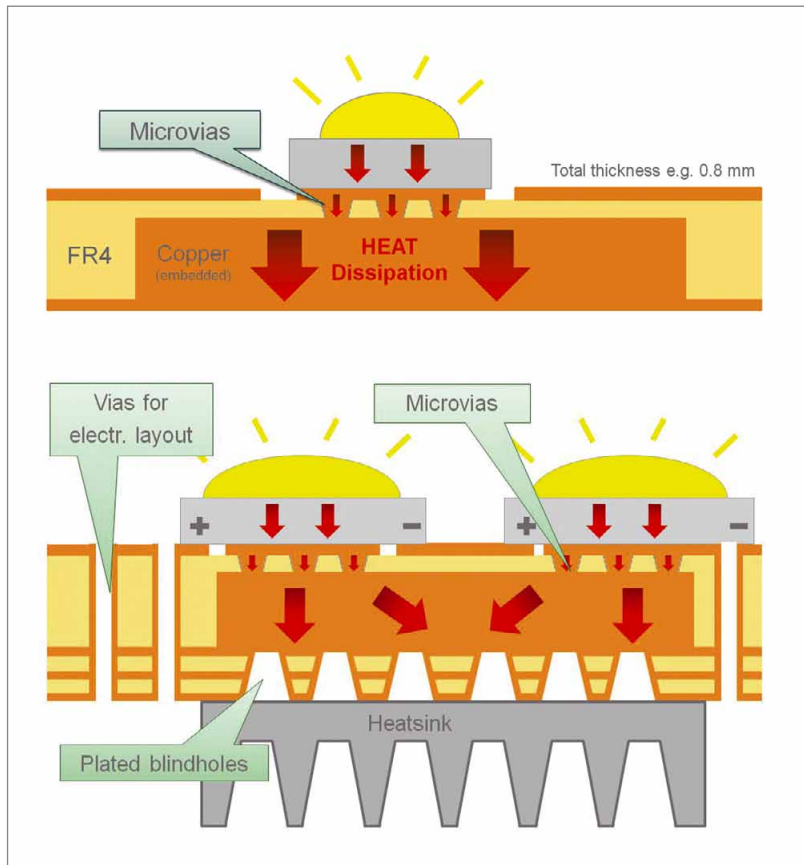

**Figure 2:**  
Exterior copper components within the type of wires or profiles are deposited directly onto the base copper by means of ultrasonic welding

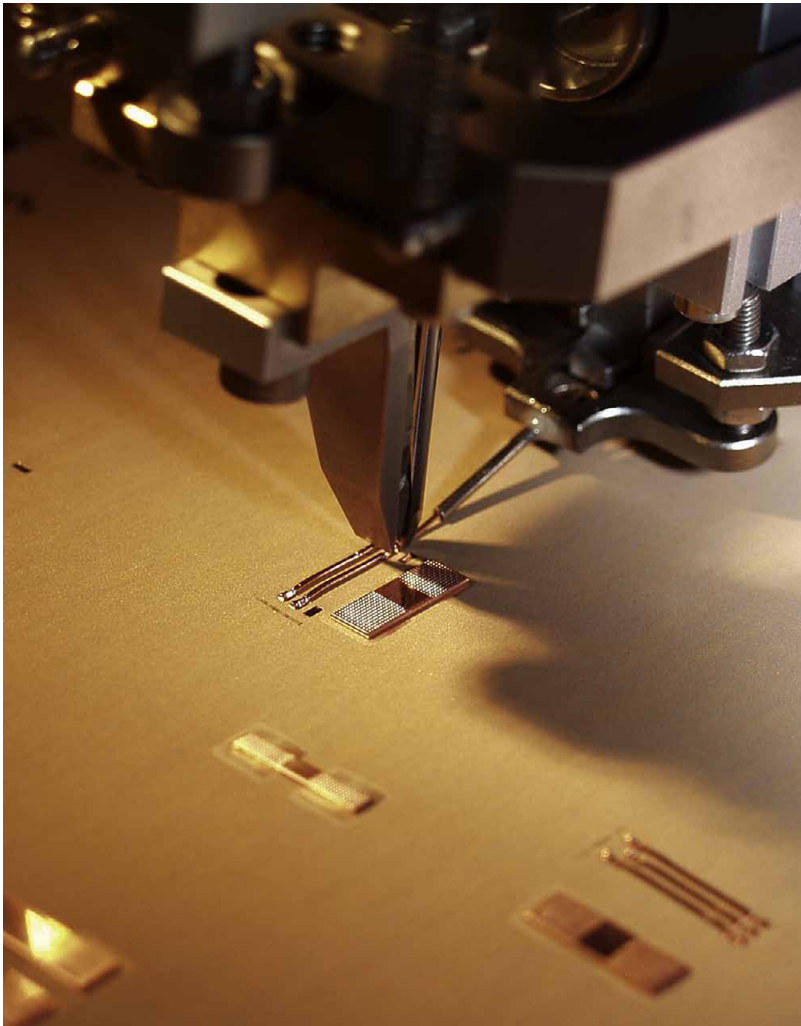

Metal-Core printed circuit boards is getting thinner and thinner, therefore losing its capability to provide appropriate electrical isolation. To solve this issue, modern copper based PCBs allow the achievement of rapid heat spreading directly below the LED and electrical insulation at the uncritical bottom side of the PCB.

At the same time, the on-going miniaturization of LEDs forces PCB manufacturers to minimize not only the board size but also the trace width, trace thickness, laminate height etc., continuously optimizing the heat dissipation from hot spots. Therefore, a crucial issue is to minimize the thickness of the board, as FR4 has – compared to copper – a low thermal conductivity. Now such boards can be provide with a thickness of just 0.8 mm instead of 1.6 mm used a few years ago. In most cases product miniaturization on the one hand and cost effectiveness on the other hand prevent the use of two separate PCBs

for the LEDs and the lighting control electronics. Standard FR4 PCB technology makes it possible to realize several electrical layers without incurring costs, whereas modern manufacturing methods allow for partially embedded copper in these boards in order to achieve a top thermal performance. This leads to another interesting point, the space economy. On average, space savings of factor 4 are possible which allows for an increase of system performance that leaves space for control and voltage gaps.

Again, the goal is to achieve rapid heat spreading directly below the LED. One example may show the way this technology works: The first example is to mount a piece of solid copper on the bottom layer which is embedded into a standard FR4 multilayer. This reduces the length of the heat path through the board significantly. Typically, the distance achieved is 60  $\mu\text{m}$  from the copper element to

the top layer. This ensures a huge cross section of a high conducting material and a high heat capacity. The heat spreading could also be improved by taking some microvias which are smaller than 150  $\mu\text{m}$  and only 100  $\mu\text{m}$  deep. These small holes either drilled mechanically or via laser down to the copper profile are treated with the standard galvanic copper plating process like the rest of the board. Furthermore, the microvias could be partly filled with copper, ensuring a simple smooth and standard soldering process.

As shown, a standard printed circuit board manufacturing process is used which saves costs compared to other heat dissipating technologies like IMS and rapid heat spreading could be easily realized. In combination with printed circuit board technologies like microvias, blind holes and thermal vias it is possible to create a closed metallic heat path between the LED and the heatsink, for example eliminating critical/typical thermal bottlenecks of common metallic-substrate-boards. This allows for the integration of intelligent light management control electronics into LED boards. HSMtec is certified to DIN EN 60068-2-14 and JEDEC A 101-A.

Even multidimensional boards are possible. The technology allows for one-time curving of the printed circuit board at selected points and slight adjustment movements during the final installation. Milled kerfs on the nominal bending points ensure that individual segments can be brought into the desired orientation by arbitrarily setting the angle of inclination. The flexible segments achieve the same stability as a separate mechanical adapter, so that the LEDs' angle of inclination remains unchanged even during intense vibration of the luminaire in operation. The high degree of design freedom makes photometric flexibility and innovative optics possible. Lighting designers have the opportunity to realize formerly unimagined possibilities as they can systematically influence the light characteristics of a luminaire and/or the illumination of objects.

**Figure 3:**  
The SpectraWow+ LED light sets a new standard for additive color mixing. The functional light for stage and architecture features an integrated RGB color mixing system



### Efficient Stage Lighting with LEDs on FR4

Realizing an innovative luminaire design as well as an effective illumination often requires the intelligent combination of many individual LEDs within one luminaire. Each LED's lighting beam needs to be focused and directed individually to achieve an appropriate illumination characteristic. A good example is the Stage Lighting system called SpectraWow+ from the Austrian company LDDE which claims to have a huge passion for light and technology, driving their success for more than 15 years.

Thanks to the early involvement of the PCB design team in the concept phase, it was possible to mutually coordinate and optimize the entire thermal design – from the PCB to the luminaire housing. Prototypes were rapidly produced in different versions with no complications, accompanied by thermal analyses, which made it possible to optimally use HSMtec technology.

This LED light sets a new standard for additive colour mixing. The functional light for stage and architecture features an integrated RGB colour mixing system. The light is available with a 40 W high power engine as RGB and also in 3200 K and 5700 K versions. The engine, in combination with a special honeycomb lens, allows a very uniform light distribution. Unwanted colour shadows, common with single lens LED lights, are history. The stable aluminium chassis offers convection cooling and guarantees completely silent operation. Changeable 20°, 30° and 45° lenses and a 4-wing barn door are optional.

SpectraWow+ is based on an HSMtec-multilayer board with four layers with embedded copper profiles. The multicolour High-Brightness LED module forms a 28 mm x 28 mm cluster of at least 33 LEDs with 2 W each. For this type of stage lighting, LDDE uses the Cree XLamp XP-E LED series (lifetime: 40,000 hours). The LED array contains 33 XP-E-RGB (9 red, 12

green and 12 blue) with CW or WW light. The XLamp XP-E LED combines the proven lighting-class performance and reliability of the XLamp XR-E LED in a package with 80 % smaller footprint. At the same time, the XLamp XP-E color LEDs provide up to 69 % more flux than the existing XLamp XR color portfolio, with an 80% smaller footprint. XLamp XP-E reduces the space between LED dice by 75%, compared to XLamp XR color LEDs. Despite this, the lighting allows settings for cross-fades, 25 ROSCO E as well as predefined colours. Individually adjustable PWM frequency and the extremely low power consumption give an advantage over traditional solutions.

A special dimming technique - soc - with internal 16 Bit resolution adjusts continuously between 0 and 100%. This fading is absolutely flicker-free; colour and intensity are controlled separately. The DMX512 USITT protocol simplifies light control; its 4-pole input/output supplies 24 V. It can be addressed via BCD. With a response time of 22 ms, the system allows for a 25 Hz strobe frequency.

### Conclusion

Without any doubt, one has to keep the application in mind. The integration of copper elements allows for a tailored thermal management solution by using FR4 substrates. This can realize significant cost reductions compared to the more common insulated substrate materials or the use of ceramic. HSMtec is a very good choice when a rapid dissipation of heat away from the LED's solder joint to the heat sink is required. To find the optimum, one has to balance the reasons to choose the right material and the right concept. A close cooperation and interaction with the PCB manufacturer in the very early stage of development may be the best way to achieve long-lived and reliable LEDs. ■

**Figure 4:**  
This is the standard FR4 PCB with HSMtec used in the SpectraWow+ LED light to provide efficient thermal management

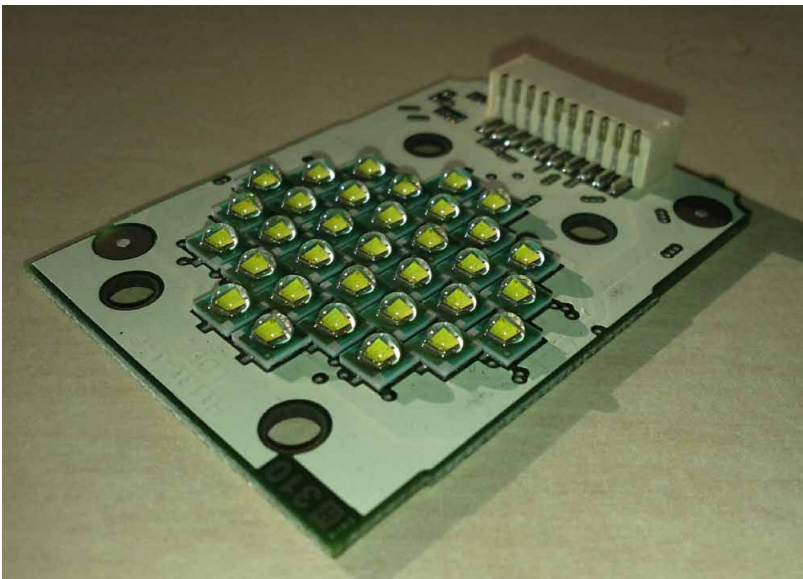

# Closing the Green Gap: A Long-Pass Dichroic Filter-Capped PC-LED

Manufacturing green LEDs with high efficacy is one of the major difficulties the LED industry is facing today. Phosphor converted LEDs cannot just generate white light, but can also be tuned to generate virtually any desired color; for instance green light. Young Rag Do from the Department of Chemistry at the Kookmin University explains which measures could help to make this approach an efficient and successful solution.

InGaN-based green light-emitting diodes (LEDs) have been studied intensely in efforts to overcome their low efficiency and stability compared with blue and red III-V LEDs. Recently, we proposed a simple combination of a long-pass dichroic filter (LPDFs) and phosphor materials in pc-LEDs which addressed the low luminous efficacy problem of III-V monochromatic semiconductor LEDs in various colors in the wavelength range between green and amber (known as the “green gap”). This technique also represented a simple approach to mitigate the sub-linearity problem of the efficacy versus the driving current which arises at a relatively low current in III-V green LEDs (known as “green droop”) to the level of a blue LED, opening the door to further research into the development of new color-converting materials (such as powder phosphors and/or quantum dots) to extend the color palette in the wavelength region of the “green gap” and to improve the efficacy and color purity of color pc-LEDs [1, 2].

Nano multi-layered LPDFs were fabricated while controlling the thickness of the high-index ( $\text{TiO}_2$ ) and low-index ( $\text{SiO}_2$ ) films in order to tune the spectral position of the reflectance band. In this study, one type of LPDF with nine periods of  $0.5\text{TiO}_2/\text{SiO}_2/0.5\text{TiO}_2$  multi-layers (535 nm for green at the band-edge of the long-wavelength) was fabricated as a capping filter to fabricate tunable full down-converted green pc-LEDs. The LPDF can transmit wavelengths from green to red and reflect the blue wavelength. Optimum amounts of green, amber or red phosphor were dispersed in a silicone binder, and the same amounts of the resulting phosphor pastes were dropped onto a cup-type blue LED to create the tunable green, amber or red pc-LED.

On top of the pc-LEDs, a LPDF-coated glass substrate was attached with an air gap. Figure 1 shows the electroluminescent (EL) spectra and the 1931 Commission Internationale d’Eclairage (CIE) color coordinates of six different green colors of LPDF-capped pc-LEDs with optimum phosphor concentrations. The EL spectra clearly show that there are very few peaks observed in the blue region of each spectrum of all of the full down-converted green LEDs due to the blocking and recycling of the pumping blue light by a capped LPDF. The results clearly confirmed that pure green color can be obtained simply by depositing any type of green powder phosphor over a blue chip in the LPDF-capped pc-LEDs [3, 4].

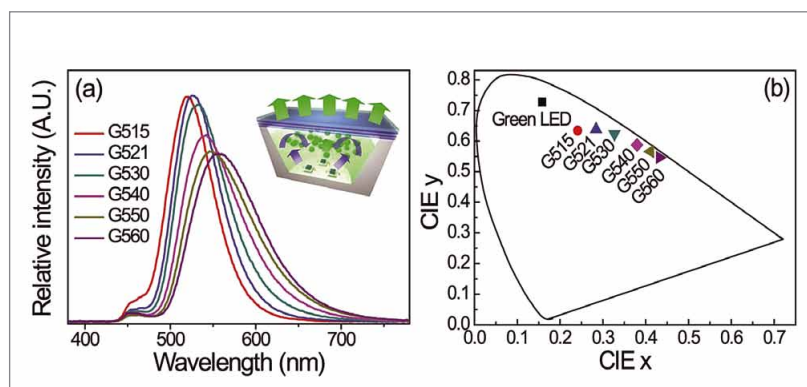

**Figure 1:** (a) The electro-luminescent (EL) spectra and (b) the 1931 CIE color coordinates of the six tunable LPDF-capped green pc-LEDs at 60 mA [6]





ORDER YOUR  
FREE  
SAMPLE  
ONLINE!

# Maximum flexibility. Minimum size. OSRON<sup>®</sup> Square.

The perfect LED solution for indoor, outdoor and compact designs

With a maximum driving current of 1.5 A, a broad range of color temperatures and color rendering indexes, OSRON<sup>®</sup> Square opens up new opportunities in indoor lighting. Thanks to its long lifetime, extremely robust design and an impressive efficacy OSRON<sup>®</sup> Square is also perfect for outdoor lighting – even under the harshest conditions. With its footprint of only 3 mm × 3 mm it provides greater freedom for creating compact and efficient designs.

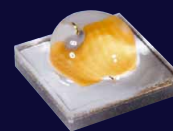

**OSRAM**  
Opto Semiconductors

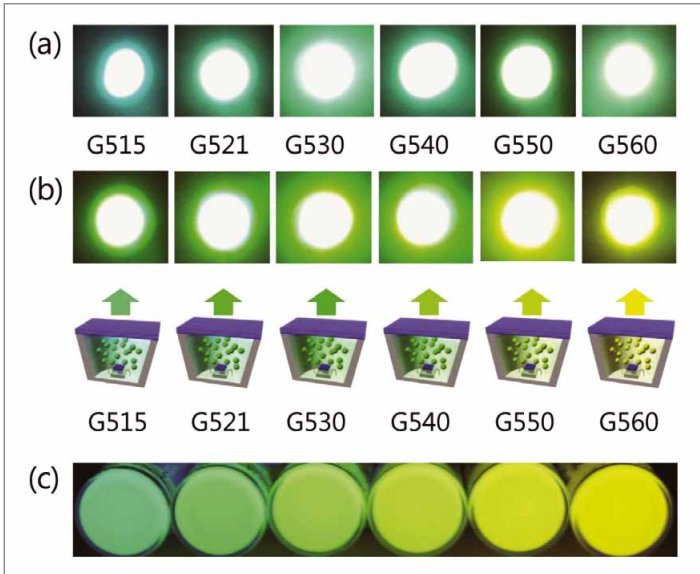

**Figure 2:** Images of (a) six tunable green pc-LEDs without LPDF, (b) six tunable green pc-LEDs with a LPDF, and (c) phosphor paste under 365 nm UV light

In our previous reports [5, 6], we selected a highly efficient InGaN blue chip (EQE = 0.49,  $\lambda_{max} = 445$ , rated current = 60 mA) as an excitation source for the green phosphors in pc-LEDs to compare the luminous efficacy and optical properties of LPDF-capped green pc-LEDs. We also selected an orthosilicate green phosphor family  $(Ba,Sr)_2SiO_4:Eu$  as a series of green phosphors capable of emitting tunable green colors in the wavelength range between bluish green (G515) and yellowish green (G560) [7].

Figure 2 shows images of a set of six tunable green phosphor pastes and pc-LEDs with and without a LPDF. The pc-LEDs with and without a LPDF contain the same amount of phosphor paste. The LPDF-capped green pc-LED shows high color purity as well as each green phosphor paste (see Figures 2(b) and (c)). The green pc-LEDs without a LPDF have low color purity due to color mixing problem at a low concentration of phosphor, as shown in Figure 2 (a).

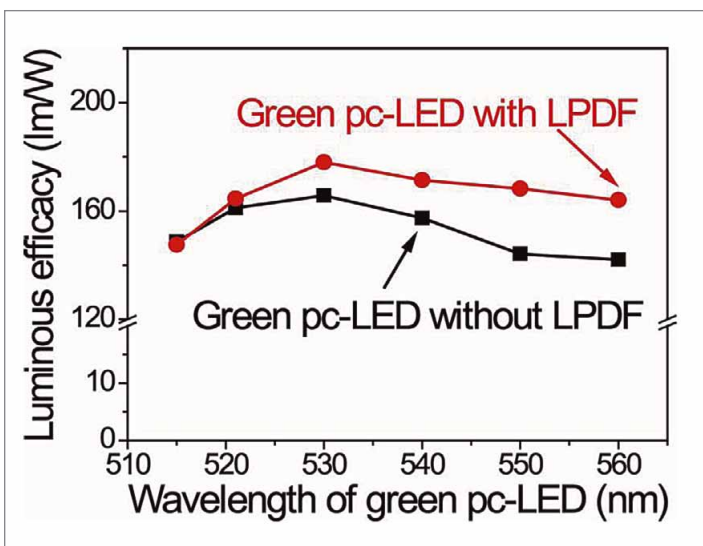

**Figure 3:** The luminous efficacy of selected green pc-LEDs with and without a LPDF with 1931 CIE color coordinates similar to the corresponding phosphor as a function of the peak wavelength of a tunable green pc-LED at 60 mA [6]

As previously reported, Figure 3 summarizes the luminous efficacy of selected green pc-LEDs with and without a LPDF showing 1931 CIE color coordinates similar to the corresponding powder phosphor as a function of the peak wavelength of a tunable green pc-LED. As the wavelength of the green pc-LED increases, an increased gap of the luminous efficacy can be observed between the green pc-LEDs with and without a LPDF owing to the decreased overlapping of the reflectance spectrum of the LPDF and the green phosphor spectrum. The luminous efficacy levels of yellowish green pc-LEDs (G550, G560) are improved by about ~17% with a LPDF at a similar color purity level and the 1931 CIE color coordinates [6].

### External Quantum Efficiency and Luminous Efficacy of Radiation

As reported in our previous publication, we measured the luminous efficacy and calculated the luminous efficiency of the radiation (LER) of six tunable green LPDF-capped pc-LEDs at 60mA. As is well known, the LER (in lumens per watt) refers to a parameter of how bright the radiation of the emission spectrum is perceived to be by the average human eye [8]. The maximum luminous efficacy ( $\eta_{lm-m}$ ) can be calculated using the LER and the Stokes shift between the emission spectrum of each green phosphor and the excitation spectrum of the blue LED. 13.6~19.6% energy losses of the Stokes shift can be considered after calculating the maximum luminous efficacies of various tunable LPDF-capped green pc-LEDs. The measured luminous efficacies ( $\eta_{lm-m}$ ) are about 143 ~ 173 lm/W (143, 161, 173, 169, 165, and 165 lm/W for each pc-LED). The ratio of the measured luminous efficacy ( $\eta_{lm-m}$ ) to the luminous efficiency of the radiation (LER) gives the external quantum efficiency (EQE,  $\eta_{e-pc}$ ) of our engineered green pc-LED samples, on the basis of the following equation [6].

$$\eta_{e-pc} = \eta_{lm-m} / LER = \eta_e \times \eta_{con} = \eta_e \times (\eta_p \times \eta_{pkg}) \quad \text{Eq. (1)}$$

The EQE ( $\eta_{e-pc}$ ) of a full down-conversion LPDF-capped pc-LED is equal to the product of the EQE ( $\eta_e$ ) of the blue pumped LED and the conversion efficiency ( $\eta_{con}$ ) of a LPDF-capped pc-LED, which is equal to the internal quantum efficiency ( $\eta_i$ ) of the phosphor times the packaging efficiency ( $\eta_{pkg}$ ) of a LPDF-capped pc-LED. We used an efficient blue LED having an EQE ( $\eta_e$ ) of 0.49 to convert EL color from blue to green in our previous report. Therefore, the conversion efficiencies ( $\eta_{con}$ ) of six green LPDF-capped pc-LEDs are measured as 0.64, 0.66, 0.70, 0.69, 0.70, and 0.71 for each full down-conversion pc-LED. If we plug both  $\eta_e = 0.49$  and  $\eta_{con} = 0.64 \sim 0.71$  into Eq. (1), the EQE of our green pc-LED samples falls into the range of 0.31 ~ 0.35. These EQE values are in good agreement with the values calculated from the ratio of the measured luminous efficacies (143 ~ 173 lm/W) to the luminous efficiencies of the radiation (LER) (454 ~ 501 lm/W). As explained in our publication, if we use the best blue LED with a theoretically high EQE value of 0.7 and the best LED package with a conversion efficiency of 0.9 in the near future, the expected EQE and measured luminous efficacies in the LPDF-capped green LEDs are estimated to be about ~ 0.63 and 286 ~ 315 lm/W, respectively, with the peak wavelength of green pc-LEDs. The LPDF-capped full-conversion pc-LED technique makes it possible to increase the luminous efficacy with an improvement of the EQE in a blue InGaN LED up to 286 ~ 315 lm/W with an increase of the peak wavelength of green pc-LEDs from 515 to 560 nm [6]. The obtained luminous efficacy of the bluish green color (515 ~ 530 nm) was reasonably good and that of the yellowish green color (540 ~ 506 nm) was significantly enhanced as compared to those previously reported. For the time being, the LPDF-capped green pc-LED can cover a wavelength of 510 ~ 570 nm, which is difficult to achieve with an InGaN green LED, at least until a highly efficient semiconductor-type green LED is developed in the future. Therefore, it can be considered that this LPDF-capped pc-LED can close the green gap in colored LEDs for a fairly long time, until a highly efficient semiconductor-type green LED is developed.

### Application of a Multi-Package White LED

Quite recently, we proposed the new paradigm of a multi-package  $R_{B,M}G_{B,M}B$  or  $R_{B,M}A_{B,M}G_{B,M}B$  ( $R_{B,M}A_{B,M}G_{B,M}$  denoted as a LPDF-capped, full down-converted, monochromatic red, amber and green pc-LED pumped by a blue LED chip) white-light approach which combines a blue LED and green/red or green/amber/red full-conversion monochromatic pc-LEDs to enhance the performance of green/amber LEDs and mixed white light [5, 6, 9]. Here, we compared the effect of six tunable green colors of LPDF-capped pc-LEDs in terms of the performance, color rendering index, and optical properties of multi-package white LEDs in an attempt to show the summarized data of both the  $R_{B,M}G_{B,M}B$  and  $R_{B,M}A_{B,M}G_{B,M}B$  multi-package. As previously reported [6, 9], we selected an InGaN blue LED (445 nm), six tunable (Ba,Sr)<sub>2</sub>SiO<sub>4</sub>:Eu green pc-LEDs (515~560 nm), (Sr,Ba,Ca)<sub>3</sub>SiO<sub>5</sub>:Eu amber pc-LED(590 nm), and the (Sr,Ca)AlSiN<sub>3</sub>:Eu red pc-LED (625 nm) for the  $R_{B,M}G_{B,M}B$  or  $R_{B,M}A_{B,M}G_{B,M}B$  multi-package white LEDs by analyzing the effect of varying the peak wavelength of a green pc-LED on the optical properties of the multi-package white LEDs at 6,500 K and 3,500 K correlated color temperatures (CCTs).

As is well known, the meaningful figures of merit in white light applications are the luminous efficacy and the color rendering index (CRI, Ra) of the white light at the same color point. It is necessary to determine the effects of different peak wavelengths of green phosphors on the optical properties of full down-converted green pc-LEDs and the recently developed multi-package white LEDs created by a simple combination of a blue LED and green/amber/red full-down converted pc-LEDs. Figures 4(a) and (b) compare the luminous efficacy of the  $R_{B,M}G_{B,M}B$  and  $R_{B,M}A_{B,M}G_{B,M}B$  multi-package white light at 6,500 K and 3,500 K as a function of the peak wavelength of the tunable green pc-LED. They were measured under a constant total applied current ( $R_{B,M}G_{B,M}B$ ; 180 mA,  $R_{B,M}A_{B,M}G_{B,M}B$ ; 240 mA) with a specified fractional current of each colored LED. The luminous efficacy of the

**Figure 4:** The luminous efficacy of  $R_{B,M}G_{B,M}B$  tri-package and a  $R_{B,M}A_{B,M}G_{B,M}B$  four-package white-light sample at (a) 6,500 K and (b) 3,500 K as a function of the peak wavelength of six tunable green pc-LEDs

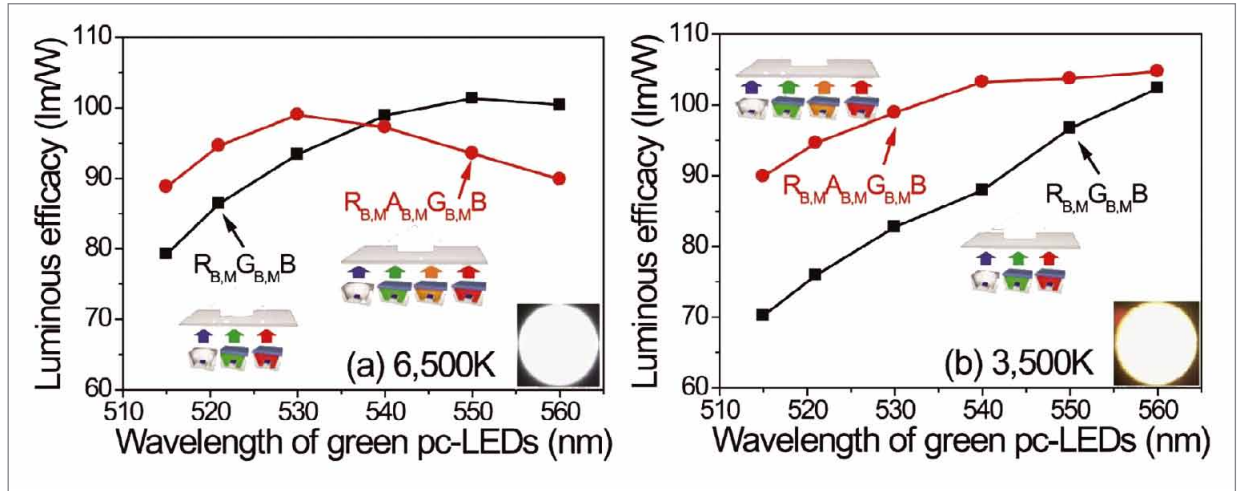

**Figure 5:** The color rendering index of the  $R_{B,M}G_{B,M}B$  tri-package and a  $R_{B,M}A_{B,M}G_{B,M}B$  four-package white-light sample at (a) 6,500 K and (b) 3,500 K correlated color temperatures (CCTs) along with the peak wavelength of the six tunable green pc-LEDs

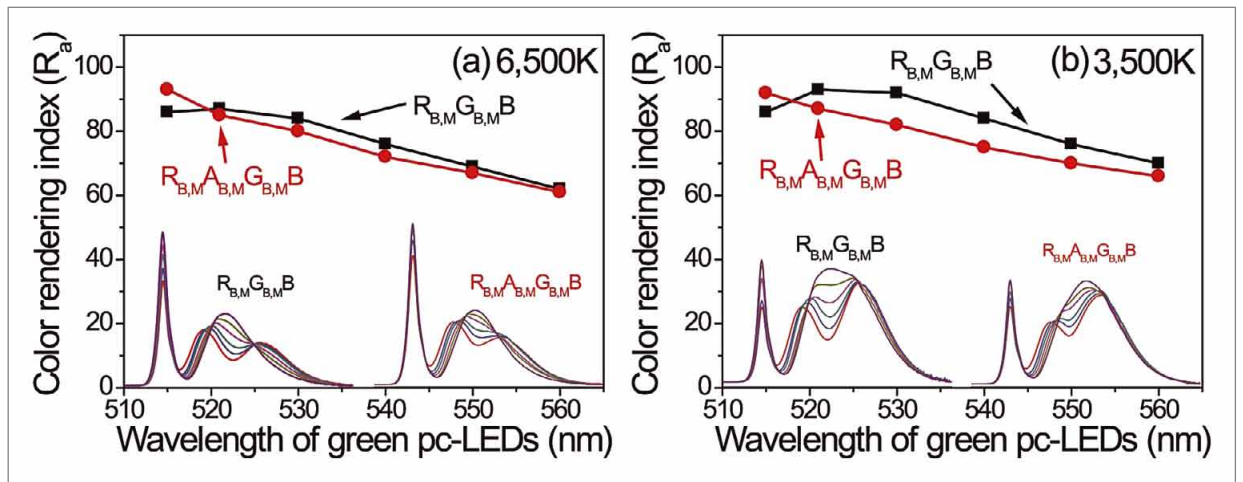

multi-package white light at CCT levels of 6,500 K and 3,500 K were determined as a function of the peak wavelength of green pc-LEDs. The luminous efficacy of  $R_{B,M}G_{B,M}B$  increased with the red shift of the green pc-LEDs and the  $R_{B,M}G_{B,M}B$  and  $R_{B,M}A_{B,M}G_{B,M}B$  white light at a CCT of 6,500 K crossed over at 540 nm. The luminous efficacy of  $R_{B,M}A_{B,M}G_{B,M}B$  white light decreased in the wavelength range of 540~560 nm at a CCT of 6,500 K due to the rapid increase of the fractional applied current of the 540~560 nm green pc-LEDs. As the peak wavelength of the green pc-LED increased, the luminous efficacy of the  $R_{B,M}G_{B,M}B$  and  $R_{B,M}A_{B,M}G_{B,M}B$  white light increased with a decrease in the fractional applied current of the red pc-LED, which has low luminous efficacy, at a CCT of 3,500 K. With an amber-colored pc-LED, the fractional applied current of the red pc-LED reduced. Therefore, the luminous efficacy of the  $R_{B,M}A_{B,M}G_{B,M}B$  white light is more efficient than that of  $R_{B,M}G_{B,M}B$  at a CCT of 3,500 K.

The insets of Figures 5(a) and (b) show the overlapped integrated emission spectra of the multi-package white light along with the peak wavelength of the six tunable green pc-LEDs at CCTs of 6,500 K and 3,500 K. At the CCT values of 6,500 K and 3,500 K, the green portion of the white color increased but the red portion of the white color decreased with an increase in the peak wavelength of the green pc-LED. When the peak wavelength of the green pc-LED was increased, the integrated emission spectra of the white light form two peaks from three peaks. For this reason, an increase in the wavelength of the green pc-LED leads to a decrease in the color rendering index of white light (Figure 5).

Figures 4 and 5 simply indicate that both the luminous efficacy and color rendering index are in a trade-off relationship in this  $R_{B,M}G_{B,M}B$  white-light system with the peak wavelength of the green pc-LED. These figures also indicate that it is difficult to select the peak wavelength of green pc-LEDs to

attain both high luminous efficacy and a high color rendering index in the  $R_{B,M}G_{B,M}B$  white-light system. For example, if we select a 530 nm pc-LED,  $R_{B,M}G_{B,M}B$  tri-package white-light provides high luminous efficacies (99 and 86 lm/W) and a moderate color rendering index (84, 92) at CCT ratings of 6,500 K and 3,500 K. In terms of efficacy, the 560 nm green pc-LED shows the best luminous efficacies for the  $R_{B,M}G_{B,M}B$  white-light system: 108 and 111 lm/W at 6,500 K and 3,500 K, respectively. On the other hand, in terms of the CRI, the 521 nm green pc-LED provides the best CRI values for the  $R_{B,M}G_{B,M}B$  white-light system: 87 and 91 at 6,500 K and 3,500 K, respectively. The  $R_{B,M}A_{B,M}G_{B,M}B$  white light using the green pc-LED with a wavelength of 530 nm shows the best result: high luminous efficacy (99 lm/W, 99 lm/W) and a moderate CRI (80, 82). If we select a wavelength of 515 nm for the green pc-LED, the  $R_{B,M}A_{B,M}G_{B,M}B$  four-color white light provides luminous efficacies of 89 lm/W and 90 lm/W

with CRI values of 93 and 92 at CCTs of 6,500 K and 3,500 K, respectively. However, if we select the green pc-LED with a wavelength of 560 nm, the  $R_{B,M}A_{B,M}G_{B,M}B$  four-color white light provides luminous efficacies of 90 lm/W and 105 lm/W and CRI values of 61 and 66 at CCTs of 6,500 K and 3,500 K, respectively.

### Outlook

The  $R_{B,M}A_{B,M}G_{B,M}B$  four-color white LEDs will require further optimization of the LPDFs and phosphors as well as improvements of the blue LED to improve the multi-package white light system. Therefore, in order to improve and optimize both the luminous efficacy and color rendering index simultaneously, it is necessary to optimize the number,

peak wavelength, and bandwidth of the primary LPDF-capped pc-LED as well as the radiative fluxes for each combination of the newly developed multi-package white-light approach, which combines a blue LED and more than two full down-conversion colored pc-LEDs. It can be expected that these types of multi-package white LEDs can cover the full-color white LED lighting market (i.e., smart LED lighting) in the near future. ■

### References:

- [1] M. Peter, A. Laubsch, W. Bergbauer, T. Meyer, M. Sabathil, J. Baur, and B. Hahn, "New developments in green LEDs," *Phys. Status Solidi A* 206(6), 1125–1129 (2009).
- [2] H. Masui, S. Nakamura, S. P. DenBaars, and U. K. Mishra, "Nonpolar and semipolar III-nitride light-emitting diodes: achievements and challenges," *IEEE Trans. Electron. Dev.* 57(1), 88–100 (2010).
- [3] J. R. Oh, S.-H. Cho, H. K. Park, J. H. Oh, Y.-H. Lee, and Y. R. Do, "Full down-conversion of amber-emitting phosphor-converted light-emitting diodes with powder phosphors and a long-wave pass filter," *Opt. Express* 18(11), 11063–11072 (2010).
- [4] J. R. Oh, S.-H. Cho, J. H. Oh, Y.-K. Kim, Y.-H. Lee, W. Kim, and Y. R. Do, "The realization of a whole palette of colors in a green gap by monochromatic phosphor-converted light-emitting diodes," *Opt. Express* 19(5), 4188–4198 (2011).
- [5] J. H. Oh, J. R. Oh, H. K. Park, Y.-G. Sung, and Y. R. Do, "New paradigm of multi-chip white LEDs: combination of an InGaN blue LED and full down-converted phosphor-converted LEDs," *Opt. Express* 19(S3 Suppl 3), A270–A279 (2011).
- [6] J. H. Oh, J. R. Oh, H. K. Park, Y.-G. Sung, and Y. R. Do., "Highly-efficient, tunable green, phosphor-converted LEDs using a long-pass dichroic filter and a series of orthosilicate phosphors for tri-color white LEDs," *Opt. Express* 20(S1), A1-A12 (2012).
- [7] J. S. Kim, P. E. Jeon, J. C. Choi, and H. L. Park, "Emission color variation of  $M_2SiO_4:Eu^{2+}$  (M=Ba, Sr, Ca) phosphors for light-emitting diode," *Solid State Commun.* 133(3), 187–190 (2005).
- [8] P. F. Smet, A. B. Parmentier, and D. Poelman, "Selecting conversion phosphors for white light-emitting diodes," *J. Electrochem. Soc.* 158(6), R37–R54 (2011).
- [9] J. H. Oh, K. N. Lee, and Y. R. Do., "Characterization of four-color multi-package white light-emitting diodes combined with various green monochromatic phosphor-converted light-emitting diodes," *Proc. SPIE* 8287, 82871I (2012).



## We Bring Innovation and Give Impression

LED downlight with trim diameters 4", 5", 6", 7" and 8", features in high efficiency over 90 lm/W and power factor 0.95.

For further information please contact SignComplex at [www.signcomplex.com](http://www.signcomplex.com)



# guangzhou international lighting exhibition

# 17<sup>th</sup>

## 9 – 12 June 2012

China Import and Export Fair Complex  
Guangzhou, China

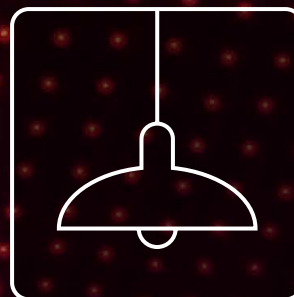
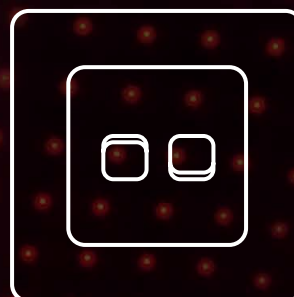

### Show highlights:

- The most influential and comprehensive lighting and LED industry event
- 6 theme zones covering full spectrum of lighting products and LED technologies
- Over 200,000 sqm spanning 21 halls, featuring more than 2,700 exhibitors in 2012
- 2011 show attracted 100,465 visitors from 116 countries and regions

For more information, please contact  
Tel: (852) 2802 7728 Fax: (852) 2598 8771  
Email: [LBguangzhou@hongkong.messefrankfurt.com](mailto:LBguangzhou@hongkong.messefrankfurt.com)  
[www.light.messefrankfurt.com.cn](http://www.light.messefrankfurt.com.cn)



messe frankfurt

# Energy Efficiency of Buck-Based Offline LED Drivers

Although the high level of LED drivers is between 80% and 90% efficiency, it is increasing steadily. However, driver efficiency varies notably with the application and system specifications. Mikka Maaspuro, Pauli Auramaa and Aulis Tuominen from the University of Turku investigated the very popular buck topology to answer the questions of why and how much efficiency varies and which components these losses are generated in.

LED technology develops fast. The light production of the LED increases and cost decreases. By this way, they rapidly gain markets from traditional light sources. LEDs will also be adopted in new lighting applications. The first applications of LED in lighting were various signaling lights. Since then, LEDs have been used in many new applications including the back lights of displays, display screens, TVs, projection systems, car lights, traffic signaling lights, road lights, decorative and architectural lights, and finally, in general lighting in offices or homes. In general lighting applications, HB-LEDs have started to replace conventional light technologies including old incandescent, newer halogen lights and most recently also fluorescent lights.

Within the LED light, there is always a LED driver whose main purpose is to source the controlled DC current to the LEDs. Other functions a LED driver normally has are built-in thermal protection and shutdown, open-circuit short-circuit protection, and - In some cases - a dimming capability and an interface to a light control bus.

The LED driver that offers these features should, at the same time, fulfill the critical requirements for physical size, costs, reliability and efficiency. High efficiency and reliability are the most important requirements. The driver should not deteriorate the excellent characteristics (energy efficiency and long lifespan) of LED light. Typically, the energy efficiency of the LED driver is around 80-90%. There can be a noticeable difference in the efficiency depending on the technology in use.

Offline LED driver input connects to line voltage. Output sources a constant dc-current and a voltage which is dependent on the load. The modern offline LED driver is a switch-mode power supply. It can be composed of just a few components including at least an inductor, a few diodes, a switching transistor and a controlling circuit. The switching device can also be integrated into a control IC. The power loss is created in all the components. The integrated LED controller IC may have a high efficiency and in that case major power losses are caused by external components.

## Energy Efficiency of the Buck-based LED driver

A simplified drawing for an offline buck driver is shown in Figure 1. In the simulation model reasonable models for the rectifier diodes, freewheel diode, switching MOSFET, its driver circuit and LEDs are used. The components of the control loop are ideal ones. The MOSFET driver has a realistic circuit model.

The most important parameters for the components used in simulations can be found in the "Driver Design Fact Box".

The driver shown in Figure 1 operates with constant switching frequency. Output current can be controlled either by adjusting the value of resistor  $R_1$  or reference voltage  $V_2$ . Feedback control is based on maximum current monitoring. Maximum efficiency can be reached at maximum output current and efficiency decreases as LED current decreases. Efficiency decreases also if the number of LEDs in the load decreases. Efficiency improves to some extent if input line voltage decreases. It is important to follow the waveform of output current. In case of small output current the driver changes to the discontinuous conduction mode (DCM). In this mode, it is typical that some oscillation occurs in the zero crossing situations as seen in Figure 3 (left side).



## We bring innovation and give impression

LED downlight with trim diameters 4", 5", 6", 7" and 8",  
features in high efficiency over 90 lm/W and power factor 0.95

**Figure1:**  
Simplified drawing  
of the buck-based  
LED driver used in  
the simulations

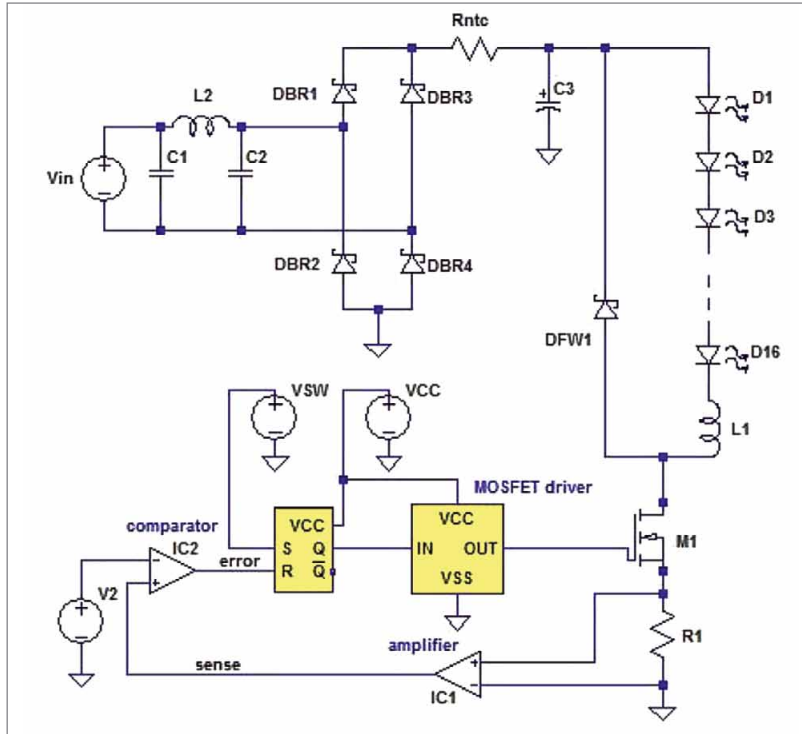

A somewhat different driver is shown in Figure 2. Output current can be set like with the driver in Figure 1. But this driver always operates in the boundary conduction mode (BCM). Changing output current results in a change in the switching frequency. The driver uses the logic of the well known timer circuit, 555. It is necessary to measure diode current. In the simulation model this has been done by using a small resistor R4. In the real driver a small coil may be used instead. The BCM operation mode has some benefits. Switching at zero voltage conditions results in a minimum power loss.

The basic buck LED driver features a rather low power factor (PF). Such simple drivers are still used in LED bulbs, especially on the most inexpensive ones manufactured in Asia. The low power factor means that although needed active power is small, the apparent power can still be high. The large scale use of LED lights would reduce needed electric power but the reduction is not as large as it could be in case the PF would be as high as with conventional incandescent lights [8]. Low PF is not only a problem with some LED lights but also with many fluorescent lights. Fortunately, the PF can always be increased to the satisfactory level by adding some circuitry.

The line filter is usually needed for noise reduction and PF improvement. Unfortunately, some power losses take place in filter inductance. The line filter itself is not enough to rise up the PF to a satisfactory level. The PF can be further improved by using either active or passive power factor corrector (PFC). Active PFC would normally include a boost stage. Active PFC could also be added as a complete integrated circuit in front of the buck driver stage. A passive PFC has certain advantages, such as simplicity, reliability, ruggedness, insensitivity to noise and surges and they do not generate high frequency EMI or switching losses. Passive PFC is constructed of large line-frequency components. The PFC attenuates harmonic components and therefore improves the PF. A drawback is that they can, to some extent, reshape the fundamental component. Several circuit topologies for a passive PFC exist. The Valley-fill rectifier is well known PFC. It is composed of three diodes and two capacitors and it will be located just after the diode rectifier. Simulations indicated that the PF can be improved while good power efficiency can be maintained. Simulated PF for the buck-based LED driver is shown in Figure 2. PF is calculated as explained in [7].

### Driver Design Fact Box

The NTC thermistor used as an inrush current limiter has nominal resistance in room temperature  $R_0 = 50 \Omega$ ,  $I_{\max(\text{rms})} = 1.1 \text{ A}$ , coefficients  $a = 1.01$ ,  $b = -1.28$  and thermal dissipation constant  $4 \text{ mW}/^\circ\text{C}$ .

The resistance versus current can be calculated using the equation

$$R_{\text{ntc}} = a \cdot (I/I_{\max(\text{rms})})^b$$

The inductor is modeled with non-saturable model having inductance of  $L = 3.3 \text{ mH}$  and on-resistance of  $R_{\text{on}} = 2.68 \Omega$ .

The MOSFET has  $V_{\text{ds,max}} = 650 \text{ V}$  and  $R_{\text{DS,on (typ)}} = 0.9 \Omega$ ,  $I_{\text{DS,max}} = 5 \text{ A}$  (8A, pulsed),  $C_{\text{iss}} = 400 \text{ pF}$ ,  $C_{\text{oss}} = 100 \text{ pF}$ ,  $C_{\text{rss}} = 10 \text{ pF}$  and  $Q_{\text{g(typ)}} = 13 \text{ nC}$ ,  $t_{\text{r}} + t_{\text{d(on)}} = 24 \text{ ns}$  and  $t_{\text{r}} + t_{\text{d(off)}} = 17 \text{ ns}$ .

The model for the MOSFET features level 3 (semi-empirical). Freewheeling diode has  $V_f = 1.6 \text{ V}$  and  $I_{\text{r}} = 20 \text{ uA}$  and  $C_T = 15 \text{ pF}$ .

The MOSFET driver circuit is able to drive loads up to  $500 \text{ pF}$  in  $25 \text{ ns}$ . Output impedance is  $16 \Omega$ .

LEDs are specified as  $I_{\text{out,max}} = 350 \text{ mA}$ ,  $V_f = 3.42 \text{ V}$ .

Design parameters for the driver were: Load 16 LEDs,  $f_{\text{osc}} = 50 \text{ kHz}$ ,  $I_{\text{out}} = 350 \text{ mA}$ ,  $I_{\text{ripple}} = 0.5 \cdot I_{\text{out}}$ ,  $V_{\text{ripple}} = 0.1 \cdot V_{\text{out}}$ .

These parameters resulted in  $L_1 = 3.3 \text{ mH}$  and  $C_3 > 3 \text{ uF}$ .

Line filter:  
 $C_1, C_2 = 330 \text{ nF}$  and  $L_2 = 1.5 \text{ mH}$ .



**Figure 2:**  
The modified buck-based LED driver which always operates in BCM mode

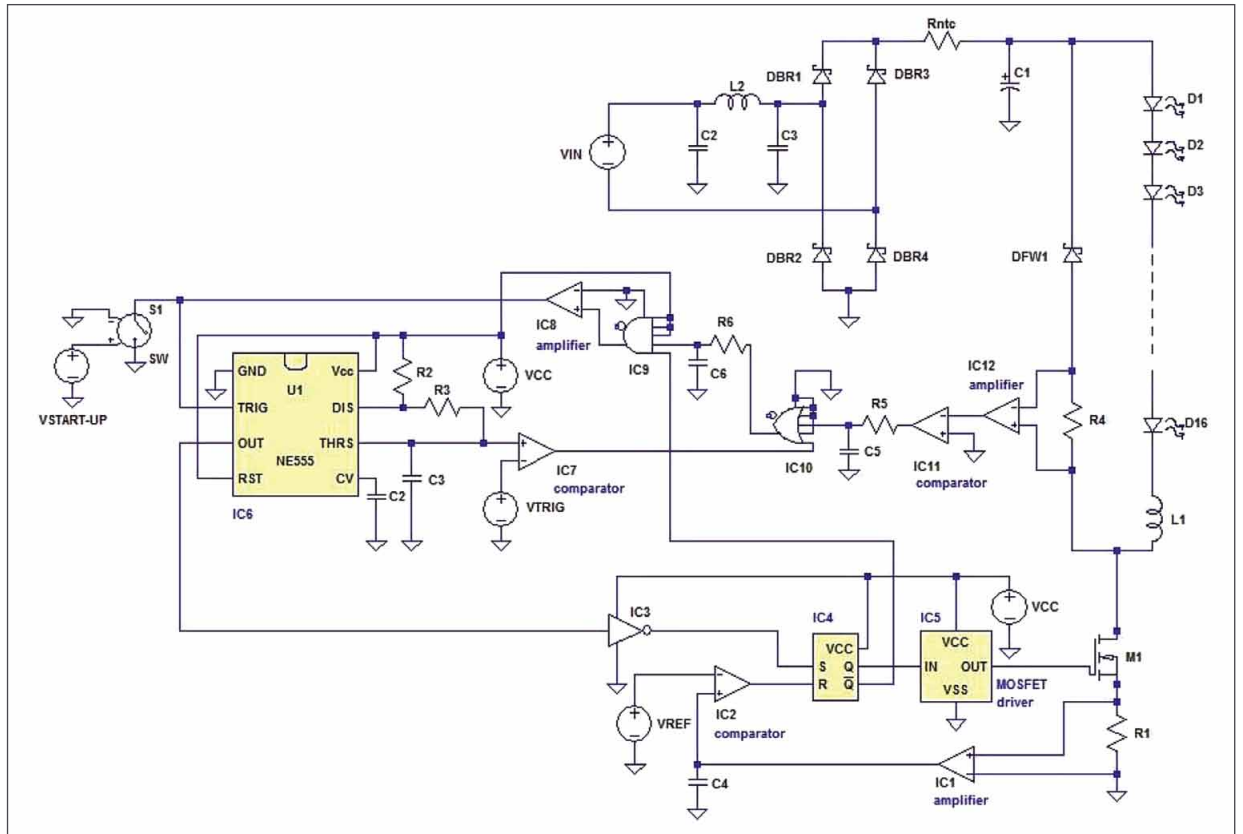

**Figure 3:**  
Simulated waveforms of the drivers shown in Figure 1 and 2. On the left, the basic driver is sourcing low output current in DCM. On the right the modified driver circuit is sourcing the same output peak current and operating in BCM

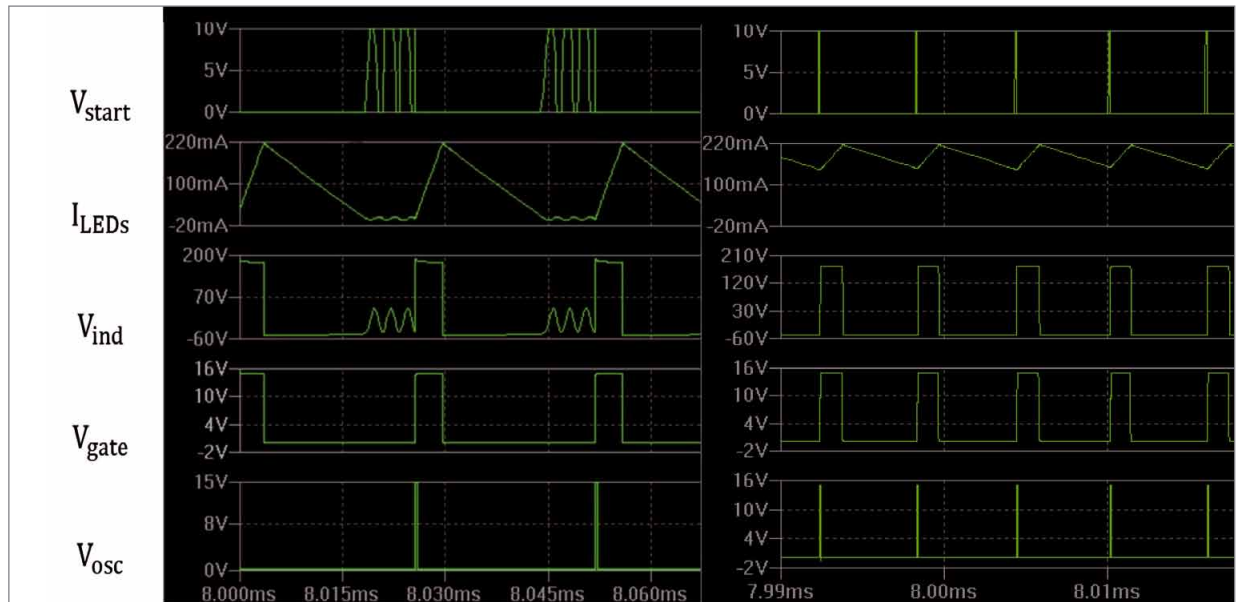

**Figure 4 (left):**  
The efficiency of the buck-based LED driver versus average LED current

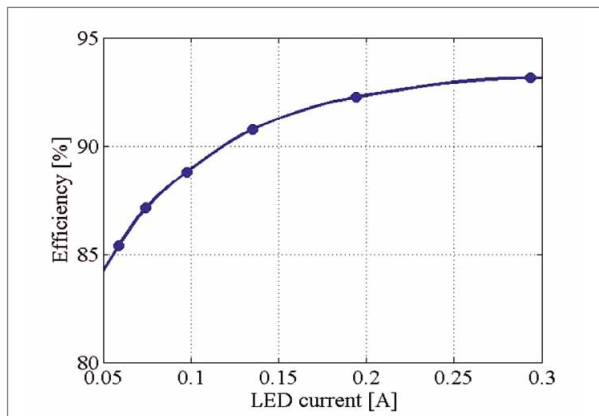

**Figure 5 (right):**  
The power factor of the buck-based LED driver versus the average LED current without PFC

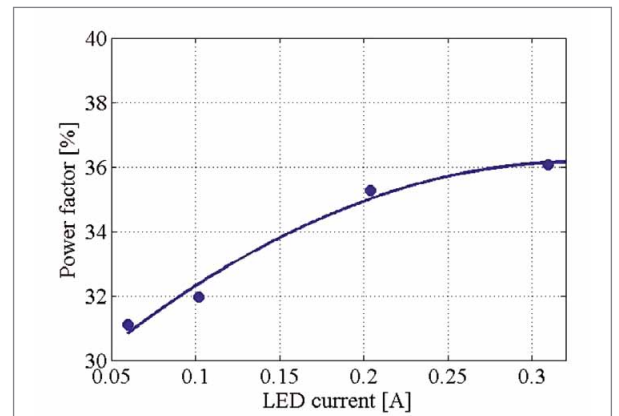

### The Power Loss Distribution of the Driver

The power loss distribution of the basic buck LED driver has been found by using the results of transient simulations. Input power will be calculated over one cycle of the line frequency. The switching cycle is fixed and the off-time is limited within the switching cycle.

The NTC thermistor in the driver acts as an inrush current limiter. The resistance of the NTC thermistor is dependent on the current which flows through it. As there is no current controlled resistance available in the basic spice simulator the resistance has to be set according to the current (INTC,rms) in each simulation run. The resistance value will be found by iterative simulations. The NTC thermistor can be located before or after the rectifier diodes. Simulations show that there is no great difference in power dissipation between the two cases.

Input power will be calculated over one cycle of the line frequency. Output power can be calculated over one cycle of the switching frequency. The thermistor seems to have rather constant and highest power dissipation in all studied cases. Dissipation of the rectifier, the diode and the inductor seem to increase as load current increases. With low switching frequency MOSFET's dissipation shows a minor contribution to total dissipation.

When switching frequency is increased, the dissipation of the MOSFET increases fast and becomes larger than the dissipation of the diode or the inductor. The leftmost bar includes the power losses of the line filter and the current sense resistor. In all simulations, the NTC thermistor was located after the diode rectifier as shown in Figure 1 and 2. The power loss distribution of a LED driver has also been issued in some other studies [1] [2].

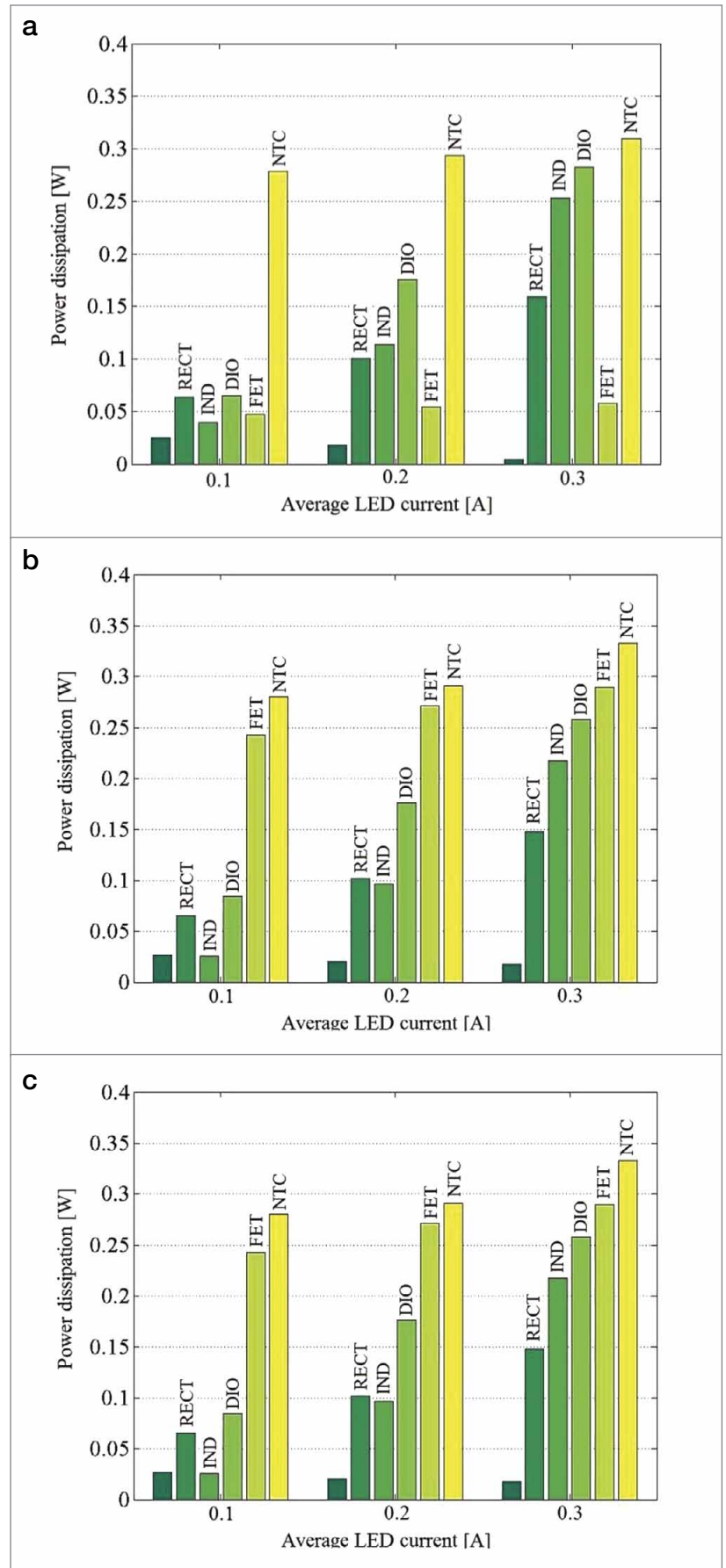

**Figure 6:** The simulated power loss distribution: a) 25 kHz b) 50 and c) 100 kHz switching frequency. Average load currents are 100 mA, 200 mA, 300 mA. Bars from right to left are NTC thermistor, MOSFET, freewheel diode, inductor, rectifier. The leftmost bar includes the current sense resistor and the line filter



**INTERNATIONAL**

The future. Illuminated.

# 2012

**PRE-CONFERENCE**  
**LIGHTFAIR Daylighting Institute®**  
**LIGHTFAIR Institute®**  
Monday, May 7 –  
Tuesday, May 8, 2012

**TRADE SHOW & CONFERENCE**  
Wednesday, May 9 –  
Friday, May 11, 2012

Las Vegas Convention Center  
Las Vegas, NV  
[www.lightfair.com](http://www.lightfair.com)

**SEE INNOVATION IN A NEW LIGHT.**  
**ONLY AT LIGHTFAIR® INTERNATIONAL**

The World's Largest Annual Architectural &  
Commercial Lighting Trade Show & Conference



In collaboration with  
The International  
Association of  
Lighting Designers



In collaboration with  
The Illuminating  
Engineering Society



Produced &  
Managed by  
AMC, Inc.

**ART COLLECTOR'S LOFT** LIGHTING DESIGN: Richard Renfro, IALD; Sarah Randall, FabÚ Tuchiya, Andrew Thompson, Renfro Design Group | ARCHITECTS: Matthew Gottsagen, Bruce Harvey, Franke Gottsagen, Cox Architects PHOTOGRAPHY: © Iwan Baan, Iwan Baan Studio

## Choosing the Optimal MOSFET for a Driver

MOSFET technology has developed a lot over the last few decades although the main interest has long been on the development of low power MOSFET [3]. Manufacturers first introduced "superjunction" power MOSFETs in late 1990's and those components soon replaced traditional DMOS components in most energy efficient solutions. New generations of MOSFETs reduce the on-resistance still keeping MOSFET capacitances in reasonable sizes and still providing high blocking voltage characteristics.

MOSFET losses come from two sources. Conduction loss is caused by the on-resistance ( $R_{ds,on}$ ). Switching losses are caused by the MOSFET's and parasitic capacitances and inductances of the printed circuit board. At low power levels, the switching losses dominate over the conduction losses.

A lateral MOSFET has lower capacitances but often higher on-resistance than a vertical (trench) MOSFET resulting in higher conducting losses. A lateral MOSFET has lower switching losses and suits a typical LED driver better.

Efficiency of a MOSFET has been studied in many papers. General level presentations [4] describe how power loss is caused by the on-state resistance and capacitances of the device. The power loss of MOSFET can be calculated manually using the data found in component's data sheet. As capacitances are strongly dependent on voltages switching losses are the most difficult to calculate.

One way to handle the nonlinear behavior of the MOSFET is to use a linear approximation in the calculation of  $C_{gd}$  ( $= C_{rss}$ ) [5].  $C_{gd}$  is calculated by using two values, the first corresponding situation where the MOSFET is fully conducting and  $V_{ds}$  is low and the second value corresponding situation where the MOSFET is closed and  $V_{ds}$  is near  $V_{dd}$ . Not only  $C_{gd}$  but also capacitances  $C_{iss}$  and  $C_{oss}$  as well are highly non-linear versus  $V_{ds}$ . This method results in the worst case values for switching losses. The linear approximation of the capacitances is inaccurate and normally results in values that are too high. This is particularly true for power MOSFET devices which  $V_{ds}$  encounters a large voltage swing. A circuit simulator is a better tool for the calculations.

However manual calculations are sometimes needed in order to make a rough comparison of MOSFETs. In this study, a number of n-channel MOSFETs were chosen.

### MOSFET selection criterions:

$$\begin{aligned} V_{ds,max} &= 600 \text{ V,} \\ I_{max} &> 1 \text{ A,} \\ C_{in} &< 500 \text{ pF and package TO-220.} \end{aligned}$$

Table 1 shows the basic equations for MOSFET's dissipations.

The MOSFETs have been listed according to their channel resistance in descending order in Table 2.

Calculations follow the procedure presented in [5]. But the linear approximation to  $C_{rss}$  was found inaccurate. Instead  $C_{rss}$  was estimated for four drain-source voltages. The average of these was used for  $C_{rss}$ . Conducting and switching losses were calculated at the specific operating conditions. Accurate values for switching current values corresponding on-off and off-on transitions have been used. Calculations have been made for three switching frequencies 25 kHz, 50 kHz and 100 kHz. For the case of 100 kHz, Table 2 lists calculated conduction losses ( $P_{con}$ ), switching losses ( $P_{cross}$ ), losses caused by the output capacitance ( $P_{coss}$ ), and gate loss ( $P_{gate}$ ). For gate losses, the driver output impedance has been set at 16 ohms. Total power loss has been listed for all cases.  $P_{sw}/P_{con}$  shows the ratio of switching origin losses to conduction losses.  $P_{sw}$  also includes gate loss and loss caused by the output capacitor. The MOSFET usually has a reverse connected parallel diode. The reverse recovery charge of the internal diode causes a rather small power loss.

**Table 1:**  
Basic equations for calculating power dissipation of MOSFET

$$\begin{aligned} P_{conduction} &= (I_D \cdot \sqrt{D_{max}})^2 \cdot R_{DS(on)} \\ P_{crossover} &= \frac{1}{2} \cdot V_{DS} \cdot I_D \cdot (t_{on} + t_{off}) \cdot f_s \\ P_{Coss} &= \frac{1}{2} \cdot C_{O(ER)} \cdot V_{DS,max}^2 \cdot f_s \\ P_{gate} &= Q_g \cdot V_{gate} \cdot f_s \\ P_{reverse\ charge} &= \frac{1}{2} \cdot Q_{rr} \cdot V_{DS} \\ P_t &= P_{conduction} + P_{crossover} + P_{Coss} + P_{gate} + P_{reverse\ charge} \end{aligned}$$

**Table 2:**  
The calculated power dissipations of some n-channel power MOSFETs suitable for a buck-based LED driver with the load of 16 LEDs in series. Average  $I_{LED} = 300 \text{ mA}$ .  $f_{osc} = 25, 50 \text{ and } 100 \text{ kHz}$

MOSFET	Ron [Ω]	Qg [nC]	Crss [pF]	Co,eff [pF]	tr [ns]	tdon [ns]	tf [ns]	tdoff [ns]	Upl [V]	Psw /Pcon	P[25kHz] [mW]	Psw /Pcon	P[50kHz] [mW]	Pcon [mW]	Pcross [mW]	Pcoss [mW]	Pgate [mW]	Psw /Pcon	P[100kHz] [mW]
1	4,4	11	24,3	30	30	10	50	23	6,2	0,7	229,0	0,9	268,2	146,5	229,5	45,0	16,5	2,0	437,5
2	3,30	11,8	35,5	26	11	24	14	19	7	0,5	152,1	0,8	185,2	109,9	154,3	39,0	17,7	1,9	320,9
3	2,20	23	46,2	31	13	9,8	12	19	4	1,1	144,5	1,9	201,0	73,26	149,7	46,5	34,5	3,1	304,0
4	1,76	25	48,3	38,5	9,5	12	17	29	6	1,4	127,9	2,2	178,6	58,61	122,0	57,7	37,5	3,7	275,8
5	1,20	33	85,8	56	14	14	19	47	6	2,9	145,7	4,9	223,6	39,96	139,8	84,0	49,5	6,8	313,2
6	1,00	12,8	44,9	32	45	16	30	36	7	2,6	109,9	3,8	150,3	33,3	104,8	48,0	19,2	5,2	205,3
7	0,90	13	47,5	50	10	14	10	23	7,5	2,1	87,1	3,6	130,7	29,97	76,2	75,0	19,5	5,7	200,6
8	0,84	14	70,7	130	10	7	12	26	5,5	4,4	141,0	7,8	233,9	27,97	111,4	194,9	21,0	11,7	355,3
9	0,63	17,4	80,7	79	23	28	27	52,5	5,5	6,3	142,2	10,3	225,0	20,98	132,5	118,4	26,1	13,2	298,0
10	0,53	19	96,1	110	12	10	15	32	5,5	7,9	146,2	13,8	246,7	17,65	129,5	164,9	28,5	18,3	340,6

TAKING PLACE ON 13th & 14th JUNE 2012

AT THE NEC, BIRMINGHAM, UK

## EXPERIENCE THE WORLD OF LEDS:

- Network with global decision makers from the LED industry
- Discover the whole LED supply chain on the exhibition floor
- Gain insight from international market leaders including Nichia, Philips, Osram, GE Lighting at the technical conference

Register Now



## Contact Us:

www.euroLED.org.uk  
 Twitter: @euroLED  
 LinkedIn: euroLED2012  
 T: +44 (0) 121 250 3515  
 E: info@euroLED.org.uk

Premier Sponsors:



Conference Sponsor:



Table 2 clearly shows that the best MOSFET for this given application is not the widest MOSFET featuring the lowest  $R_{ds,on}$ , but MOSFET no. 7. Column  $P_{sw/P_{con}}$  shows the ratio of switching losses over the conduction losses. With 100 kHz switching frequency, switching losses are significantly higher than conduction losses in every case. In case of the widest MOSFETs which have  $R_{ds,on} < 1 \Omega$  the switching losses are dominating in all the cases. MOSFET no: 7 was used in simulations which resulted in the power dissipation of various components and is shown in Figure 3.

## Conclusions

This study focused on the power dissipation of various components of the buck-based LED driver. It became clear that the thermistor used in surge current limiting, in this case, seemed to cause the largest power dissipation. The power dissipation of the thermistor seems to be rather constant in all load conditions.

Dissipation of the rectifier diodes, the inductor and the diode seem to increase as load current increases.

The dissipation of the MOSFET increases when switching frequency increases. It is rather difficult to manually calculate the switching losses of the MOSFET. Circuit simulator is needed to find the accurate power dissipation of the MOSFET. The best choice for the switching device is usually not the MOSFET which features the lowest  $R_{ds,on}$  but the device which features the lowest switching losses. ■

## References:

- [1] Huan-Jen Chiu, "A High-Efficiency Dimmable LED Driver for Low-Power Lighting Applications", IEEE Transactions on Industrial Electronics, vol. 57, No 2, Feb. 2010.
- [2] 7W, 90-135 Vac, 500 mA LED Driver, Design Note DN06050/D rev. 0, ON Semiconductor, Jan.2009.
- [3] Jon Mark Hancock, "Superjunction FETs Boost Efficiency in PWMs", Power Electronics Technology, p. 20-29, July 2005.
- [4] Andrew Smith, "Calculating power loss in switching MOSFETs", Power Management Designline, August 2, 2011.
- [5] Dusan Graovac, "MOSFET Power Loss Calculation Using the Data-Sheet Parameters", application note, Infineon Inc., July 31, 2006.
- [6] Steve Windler, "Power Supplies for LED Driving", Elsevier Inc., 2008.
- [7] W. Mack Grady, Robert J. Gilleskie, "Harmonic and how they relate to power factor", EPRI Power Quality Issues & Opportunities Conference, San Diego, CA, USA, Nov.1993.
- [8] Siegfried Luger, Arno Grabher-Meyer, Lukas Gorbach, "Electrical Considerations of LED Bulbs", LED Professional, Sept/Oct 2009.

# Imprint

LED professional Review (LpR)  
ISSN 1993-890X

## Publisher

Luger Research e.U.

Institute for Innovation & Technology  
LED professional Dept.  
Moosmahdstrasse 30  
A 6850 Dornbirn, Austria / Europe

phone +43 5572 394 489  
fax +43 5572 394 489 90  
editors@led-professional.com  
www.led-professional.com

## Publishing Editors

Siegfried Luger  
Arno Grabher-Meyer

phone +43 5572 394 489  
phone +43 5572 394 489-18  
editors@led-professional.com

## Int. Account Manager

Theresa Koenig

phone +43 5572 394 489-20  
theresa.koenig@led-professional.com

## Cover-page

Image: Arno Grabher-Meyer, LED professional; Vossloh-Schwabe Street  
Lighting Module  
Artwork: Thomas Klobassa, ©LED professional 2012

## Copyrights – Luger Research e.U.

The editors make every reasonable effort to verify the information published, but Luger Research e.U. assumes no responsibility for the validity of any manufacturers, non profit organisations or individuals claims or statements. Luger Research e.U. does not assume and hereby disclaims any liability to any person for any loss or damage caused by errors or omissions in the material contained herein, regardless of whether such errors result from negligence, accident or any other cause whatsoever. You may not copy, reproduce, republish, download, post, broadcast, transmit, make available to the public, or otherwise use LED professional Review (LpR) content without prior written consent from Luger Research e.U. – Institute for Innovation & Technology, Austria. ■



## LED professional Review (LpR) - Annual Subscriptions

### LpR Digital Magazine

- 6 issues
- pdf download
- high resolution pictures and graphs
- printable
- commercial use
- access to all previous issues
- Euro 78.80

<http://www.led-professional.com/subscription>

### LpR Printed Magazine

- 6 issues
- Euro 158.40

Next LpR Issue - May/June 2012

Modules & Replacement Lamps

**LED** professional | SYMPOSIUM  
+EXPO  
LpS 2012

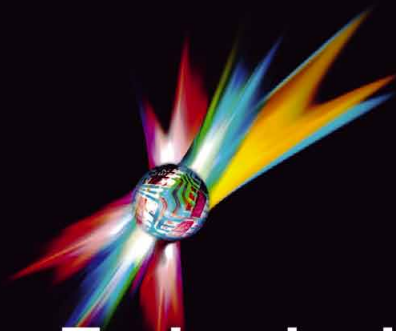

**LED Lighting Technologies**  
International Winning Approaches

**25-27 SEPTEMBER 2012  
BREGENZ | AUSTRIA**

PROGRAM AVAILABLE  
EARLY BIRD  
REGISTRATION  
OPEN NOW!  
[www.lps2012.com](http://www.lps2012.com)

### CONTACT:

LUGER RESEARCH | Moosmahdstrasse 30 | 6850 Dornbirn  
T +43 5572 39 44 89 | F +43 5572 39 44 89 90  
[info@lps2012.com](mailto:info@lps2012.com) | [www.lps2012.com](http://www.lps2012.com)

**e:lumix**  
Technologie AG

**OSRAM**  
Opto Semiconductors

**TRIDONIC**  
enriching your ideas

We can do a lot for your light.

## Impressive solutions for your LED products.

The LED Solution Box from Tridonic is a versatile package that includes the light source and helps you find the solution you want – components, light modules, systems and renowned Tridonic service. With Tridonic, you have everything under control, whether you choose conventional or LED lighting. **We devote all our energy to your light.**  
[led.tridonic.com](http://led.tridonic.com)

**light+building** 2012 Hall 2.0, Booth A30



**LED Solution Box – All your LEDs under perfect control:**  
components and systems for your product solution.  
[led.tridonic.com](http://led.tridonic.com)

Perfect for a wide range of lighting tasks in general illumination.



**TALEXconverter**  
For indoor and outdoor



**TALEXengine STARK DLE TWIST**  
For luminaire installation

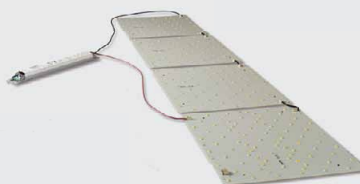

**TALEXengine STARK QLE und LLE**  
For general illumination with integrated emergency lighting functionality



2<sup>nd</sup> annual LED professional Symposium & Exhibition

**LED** | SYMPOSIUM  
professional | +EXPO

**LpS** 2012



PROGRAM AVAILABLE  
EARLY BIRD  
REGISTRATION  
OPEN NOW!  
[www.lps2012.com](http://www.lps2012.com)

# LED Lighting Technologies

International Winning Approaches

**25-27 SEPTEMBER 2012 | BREGENZ | AUSTRIA**

**CONTACT:** LUGER RESEARCH | Moosmahdstrasse 30 | 6850 Dornbirn | T +43 5572 39 44 89 | F +43 5572 39 44 89 90  
[info@lps2012.com](mailto:info@lps2012.com) | [www.lps2012.com](http://www.lps2012.com)

**Europe's Foremost LED Lighting Technology Event**

**e:lumix**<sup>®</sup>  
Technologie AG

**OSRAM**  
Opto Semiconductors

**TRIDONIC**  
▼enlightening your ideas