

Light+Building Review

Zhaga Standardization

LED Module Selection Considerations

Driverless LED Light Engines



# LUXEON®

## Light that works

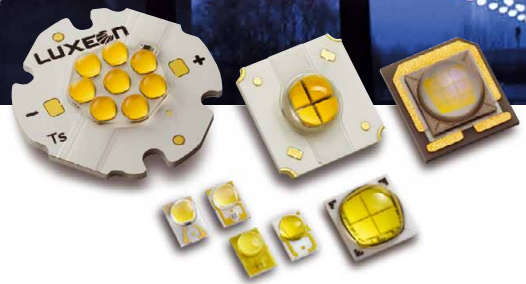

In shops and offices, in tunnels and on roadways, LUXEON works. With unparalleled efficiency, quality of light and reliability, the LUXEON portfolio simplifies your solutions and shortens your development time.

Learn more about how the LUXEON portfolio can help you, visit our website.

[www.philipslumileds.com](http://www.philipslumileds.com)



**PHILIPS**  
**LUMILEDS**



## Light+Building – 5 Key Trends

The world's biggest trade fair for lighting and building services technology, the Light+Building 2012, drew about 200,000 attendees to Frankfurt in April, giving a 7 percent attendee-increase in comparison to the last event in 2010.

“Light+Building is the world's biggest trade fair for energy efficiency. Accounting for 40 percent of the total, buildings are the world's biggest consumer of energy and, therefore, play an important role for smart grids and decentralized energy supply,” said Wolfgang Marzin, president and CEO of Messe Frankfurt. He added, “The very good result shows the extent of worldwide demand for environmentally friendly light and building services solutions and that Light+Building is the foremost meeting place for the industry and decision makers. As we learnt in many discussions during the fair, the results exceeded the sector's expectations.”

LED solutions dominated the lighting industry presentations and the LED professional team identified 5 key trends in Frankfurt influencing product development. Firstly, Zhaga, an industry standard for interchangeability of LED light engines, presented their first results. A lot of companies presented Zhaga compatible modules and components such as round downlight modules. Secondly, the performance parameters of LED lighting systems are continuously increasing. Besides efficiency, values for CRI, binning tolerances and reliability are also getting better and better and are still not in a saturation stage. Thirdly, flat lighting systems, especially those with a strong influence from OLED technology, are pushing the market with design-oriented concepts. Fourthly, module technologies with harmonized system parts like reflectors, cooling devices, and the like, reduce the entrance barrier into LED lighting and enforce a closer cooperation between all the elements on the supply chain. Fifthly, LED lighting is becoming more a system element of a building with integration into its management systems and intelligent control functionalities.

Frans van Houten, Chief Executive Officer at Philips said, “LED Lighting plays a unique role in creating meaningful experiences for people and delivers significant energy savings.”

If you'd like more information about the Light+Building event, there is a detailed report in this issue as well as an interview conducted in Frankfurt with Zhaga spokesman Greg Galluccio about the history and background of the Zhaga initiative.

Yours Sincerely,



Siegfried Luger  
Publisher

PS: 2nd Annual LED professional Symposium & Exhibition – LpS 2012  
Program Available  
Early Bird Registration Open Now

[www.LpS2012.com](http://www.LpS2012.com)

# Content

■	Editorial	p 1
	Imprint	p 60
	COMMENTARY	p 4
	News - PRODUCTS	p 6
<hr/>		
■	<b>EVENT</b>	
	Light+Building Review – Zhaga Standard, High Quality Lighting & OLEDs by Arno Grabher-Meyer, LED professional	p 26
<hr/>		
■	<b>INTERVIEW</b>	
	Zhaga - Insights into the New LED Lighting “Standard” for Light Engines Interview with Zhaga spokesperson Greg Galluccio, Leviton by Siegfried Luger & Arno Grabher-Meyer, LED professional	p 38
<hr/>		
■	<b>APPLICATION</b>	
	LED Module Selection Considerations – The Datasheet and Beyond by John Yriberry, Director of Global Application Engineering, Xicato	p 42
<hr/>		
■	<b>ELECTRONICS</b>	
	Driverless LED Light Engines by Bob Kottritsch, Vice President, & Mike Miskin, CEO, Lynk Labs	p 50
	Thermal Considerations for Driving LED Strings with CCRs by Steve Sheard, Strategic Programs Manager, ON Semiconductor	p 56

## Advertising Index

Philips Lumileds	C2
Recom	p 3
LpS 2012	p 5
Carclo	p 7
Vossloh-Schwabe	p 9
General Electric	p 11
Everlight	p 12
Micrel	p 13
LedLink	p 15
Seoul Semiconductor	p 17
iLLUMiNNO	p 18
CIOE Shenzhen	p 18
SignComplex	p 19
Farnell	p 21
ProLight Opto Technology	p 22
Global Lighting Technologies	p 23
EBV Elektronik	p 24/25
Instrument Systems	p 31
Infineon	p 36
SignComplex	p 40
Edison	p 41
Lighting Japan	p 45
Bodo Power Magazine	p 49
Guangzhou Int. Lighting Exhibition	p 55
euroLED	p 58
Lightfair International	p 59
EBV Elektronik	C3
Philips OEM	C4



„More Light!“

J.W. Goethe, Philosoph



„We‘ll take care!“

Karsten Bier, CEO

**RECOM**  
LIGHTING



### Sebastian Lyschick

Mr. Lyschick earned his advanced vocational certificate of education at Siemens AG and then studied economic engineering in Cologne, Germany. During his course of study, he had several internships and wrote his undergraduate thesis on the "Development of market models for building and systems engineering". He has been working at Osram Opto Semiconductors since 2008, where he is responsible for the global Osram LED Light for you (LLFY) partner network. In this position, he manages the network internationally, heads key projects within the network and enhances its visibility by way of continuing education programs, trade fairs and exhibitions. He further works to develop the network, e.g. through a changed certification process.

## THE FUTURE LIES IN LED LIGHTING – TRADE FAIR IMPRESSIONS OF AN EXHIBITING NETWORK

Light+Building without doubt is the largest and most important trade fair in the world for all aspects of lighting, even for a technically oriented network like LED Light for you. And Light+Building will maintain its position, because for several years now it has been evolving from a "design show" to a trade fair focused on lighting solutions. In this way, it is participating in the change presently affecting the entire lighting industry. For example, Light + Building today is the ideal platform to present LED lighting solutions to a global public: from an LED spot and a desk lamp to an office luminaire and an LED streetlight.

The partner network's goal was to show that even a complex LED luminaire system need not be viewed as rocket science. The network helps its customers - large, medium and small manufacturers, both professionals and newcomers from any number of industries - to develop unique, custom LED lighting solutions. Over 90 certified partners worldwide have taken on the task of advising customers in the development of standard solutions, and above all the implementation of unusual ideas adapted to specific fields of application and individual needs. This makes it possible to optimally exploit the potential of innovative, cutting-edge LED lighting, with its virtually unlimited design and application possibilities.

The great interest demonstrated by visitors to the trade fair are clear indicators that the time is ripe for LED solutions. A lot has happened in the development of this technology over the past few years to tremendously expand its fields of application. Numerous products are market ready: luminaires for industrial buildings as well as designer, medical, work, indoor and outdoor luminaires. Architects, designers and companies in a variety of industries have become more knowledgeable about LEDs. They are starting to understand the possibilities of LEDs and think about how and where they can put the new technology to use.

Light+Building has become considerably more important, too, as reflected in its presence at the trade fair. Whereas the network exhibited at a small stand in a niche area six years ago, it attracted an immense amount of interest at this year's Light+Building with a stand in net-like design. The Osram partner network culls the newest technologies from various disciplines and combines them for use in the lighting sector. The number of visitors to our stand, which was more than a third higher than in 2010, combined with the tangibly higher quality of the discussions between experts, are factors that show us the LED lighting community is on the right path and that Light+Building is an increasingly important platform for presenting products and services.

S.L.



SAVE UP TO 15%  
EARLY BIRD  
REGISTRATION  
OPEN NOW!  
[www.lps2012.com](http://www.lps2012.com)

# LED Lighting Technologies

## International Winning Approaches

### 2<sup>nd</sup> International LED professional Symposium +Expo

LpS (LED professional Symposium) is Europe's foremost LED lighting technology event for lighting experts in industry and research. The symposium covers LED lighting technologies for luminaries, lamps and modules focusing on new system approaches, new components and the most up to date design methodologies.

#### Keynote Speakers / Workshop



**Michael Ziegler**

Member of the Photonics Unit at the European Commission's General Directorate for Information Society and Media

**"The Future of Solid State Lighting in Europe"**

*An overview of EU initiatives launched under the Digital Agenda for Europe in the area of Solid State Lighting.*



**Dr. Hans Nikol**

VP LED Technology Strategy, Philips Lighting, Netherlands

**"LED Technology Overview & Trends"**

*Summary of recent LED technology trends and strategies for future lighting system developments.*



**Prof. DI Andreas Schulz**

Professor HAWK Hildesheim and CEO LichtKunst Licht AG, Germany, Member of the IALD Board of Directors

**"Challenges and Opportunities of LED Technology in Lighting Projects"**

*Demonstrating state-of-the-art technology for LED lighting designs using the example of a museum project.*



**Prof. DDr. Sergei Ikovenko**

Director and Chief Specialist, Innovation Leadership Programs, Massachusetts Institutes of Technology (MIT), USA

**"Operating Beyond Competition" - Workshop**

*Competitive patent circumvention techniques using TRIZ with examples from LED lighting and other industries.*

### ■ EVENT OVERVIEW



Over **900** experts from all LED lighting technology fields anticipated.



Top class contributors will present **30** lectures covering highly relevant technologies.



More than **70** exhibitors expected from all over the world.

### ■ SYMPOSIUM SESSIONS

- ▶ Disruptive LED Technologies
- ▶ LED Light Conversion Technologies
- ▶ LED Optics Design
- ▶ LED Electronic Systems Design
- ▶ LED Production Technologies & Materials
- ▶ LED System Standardization & Measurement
- ▶ LED System Reliability
- ▶ LEDs in Outdoor Lighting Applications

**25-27 SEPTEMBER 2012 | BREGENZ | AUSTRIA**

**CONTACT:** LUGER RESEARCH | Moosmhdstrasse 30 | 6850 Dornbirn | T +43 5572 39 44 89 | F +43 5572 39 44 89 90  
[info@lps2012.com](mailto:info@lps2012.com) | [www.lps2012.com](http://www.lps2012.com)

## LUXEON R from Philips Lumileds

Philips Lumileds has launched LUXEON R, designed for outdoor and industrial lighting applications such as streetlights, high-bay lights, wall packs and bollards.



**LUXEON R makes outdoor lighting solutions more efficient and appealing**

LUXEON R is an Illumination Grade LED, and therefore is hot tested and specified so that its performance at operating conditions is well understood. In addition, LUXEON R offers freedom from binning to ensure uniformity from one solution to the next. Furthermore, LUXEON R is footprint compatible with LUXEON Rebel and Rebel ES, while delivering more light output, higher efficacy and better quality of light. With a minimum CRI of 70, LUXEON R meets the most stringent standards required by municipalities, utilities, and property owners today.

LUXEON R has already been implemented in Lumec's SoulCity, a uniquely modern family of outdoor lighting solutions that blends uniformity in design and optimum style with the performance and energy efficiency of LED technology. ■

## Everlight Introduces Shwo D LED Series

Everlight Electronics introduces a brand new bright and economic, compact high power, high brightness LED package. The Shwo D series is a surface-mount high-power device featuring high brightness combined with a compact size (3.5x3.5x0.58 mm) that is suitable for all kinds of lighting applications such as general illumination, flash, spot, signal, industrial and commercial lighting.



**Everlight's new compact Shwo D Serie is powerful and efficient**

### Features:

- Small package with high efficiency
- ESD protection up to 8KV
- Soldering method: SMT
- Moisture Sensitivity Level: 1
- RoHS compliant
- Matches ANSI binning
- Lumens Maintenance testing conforms to IESNA LM80 test method applications

With a standard operating current of 350 mA, the Shwo D family can be driven at 1 W with a minimum luminous flux (lm) of up to 110 lm at 6500 K or 80 lm at 3000 K. The thermal pad of this device is electrically isolated, providing convenience in thermal and electrical design. The Shwo D series also has the advantage of low thermal resistance. It is one of the most promising devices in Everlight's high power Lighting Series products and is ready to face the challenges of today's Solid-State Lighting requirements. ■

## New Cree XLamp® MT-G2 LEDs based on SC<sup>3</sup> Technology

LED lighting leader Cree announces the MT-G2 LED – the first EasyWhite® LED array built on the SC<sup>3</sup> Technology Platform. The new XLamp® MT-G2 LED delivers LED lighting manufacturers 25 percent brighter LEDs compared to the previous MT-G, enabling a wider spectrum of high lumen applications. The MT-G2 LED shares the same footprint as the original MT-G LED.

Featuring Cree® EasyWhite Technology, the MT-G2 LED delivers up to 2100 lumens in warm white (3000 K) at 25 watts, 85°C and provides the industry's best color consistency, with superior optical control.



**Cree updates the XLamp® MT-G to MT-G2, which delivers 25% higher output in the same compact footprint**

The MT-G2 LED is the latest product built on Cree's revolutionary SC<sup>3</sup> Technology Platform, joining XB-D, XT-E, XT-E High-Voltage and XM-L High-Voltage LEDs. The SC<sup>3</sup> Technology Platform leverages Cree's advanced silicon carbide technology, features advancements in LED chip architecture and phosphor, and showcases a new package design to deliver the most advanced LED components in the industry.

With an 8.9 mm x 8.9 mm footprint, the MT-G2 LED is available in 2- and 4-step EasyWhite® color temperatures ranging from 2700 K to 5000 K. The new LEDs are available in minimum 80 and 90-CRI options and feature multiple voltage selections, including higher voltages. ■

## Sharp Improves its 4W & 7W Mini Zenigata LEDs

The new product generation is again based on a small plate made of technical ceramics (aluminium oxide Al<sub>2</sub>O<sub>3</sub>) with the dimensions 15 x 12 x 1.6 mm. Efficiency was improved by up to 11% due to technical progress. The new generation of 4 & 7W arrays is characterized by four properties: Compact, light, economical and brighter than before.

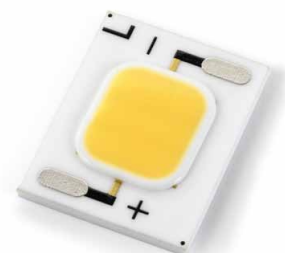

**The new generation of the 4 W and 7 W Mini Zenigata series from Sharp shines with an efficiency of up to 91 lm/W**



• GLOBALISE • INNOVATE • SPECIALISE • INTEGRATE • GLOBALISE

carclo  
technical plastics  
Optic Specialists

FOCUSED ON THE FUTURE OF LIGHTING

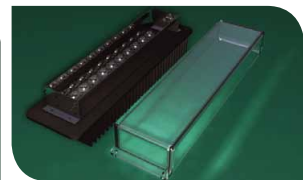
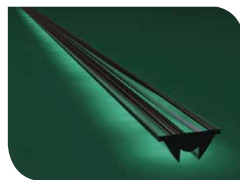

• INNOVATE • SPECIALISE • INTEGRATE • GLOBALISE • INNOVATE • SPECIALISE

Discover our **new** product range at  
[www.carclo-optics.com](http://www.carclo-optics.com)

United Kingdom • USA • China • India • Czech Republic

carclo  
technical plastics  
technical plastics  
carclo



Depending on the module, the new types provide a luminous flux of up to (typically) 585 lumens, with a light efficiency of up to 91 lm/W at nominal operating data, a high CRI value of 82, and a long service life of 40,000 hours at an operating temperature of up to 90°C.

The 4 W arrays can be operated with an increased constant current of 500 mA, thus making them capable of reaching a luminous flux of up to 400 lm. With the 7 W arrays, a luminous flux of up to 830 lumens can be reached, if they are operated with a current of 680 mA. The color temperatures of the new white-light LED arrays range from 2,700 to 6,500 K

The Mini Zeni LED modules from Sharp are suitable for a range of applications like spot lighting and for use in LED retrofit lamps. ■

## Cree SC<sup>3</sup> Technology Allows Brighter XLamp® HV-LEDs

Cree announces the availability of brighter Cree® XLamp XT-E and XM-L High-Voltage LEDs to provide manufacturers more efficient, cost-effective components. The new, high-performance LEDs leverage the SC<sup>3</sup> Technology Platform, which is built on Cree's advanced silicon carbide technology, and features advancements in LED chip architecture and phosphor, and boasts a new package design to deliver the most advanced LED components in the industry.

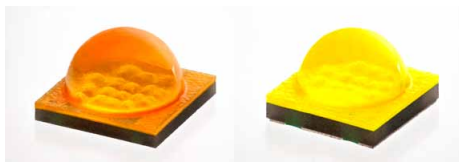

**Cree updates its two high voltage LED types, Cree® XLamp XT-E and XM-L, which were introduced last autumn, and boosts them to higher efficiency and luminous flux**

The XT-E and XM-L High-Voltage LEDs deliver up to 22 percent more lumens than their predecessors. The XT-E HV LEDs can deliver up to 357 lm at 3 watts in cool white (6500 K) and up to 275 lm at 3 watts in warm white (3000 K), both at 85°C. The XM-L HV LEDs can deliver up to 647 lm at 6 watts in cool white (6500 K) and 555 lm at 6 watts in warm white (3000 K) both at 85°C.

They are designed to use lower cost, higher efficiency and smaller size drivers than standard-voltage LEDs. The brighter high-voltage XLamp XT-E and XM-L LEDs provide comparable performance to their standard-voltage counterparts, eliminating the trade-off of optimizing for either LED efficacy or driver efficiency. ■

## Bridgelux Expands Decor Ultra High CRI Series

Bridgelux announced the expansion of its highly successful Decor™ line of ultra-high color rendering index (CRI) LED arrays, addressing growing demand in the shop and retail, architectural, hospitality and museum lighting markets for the energy efficiency and high quality light offered by LED technology.

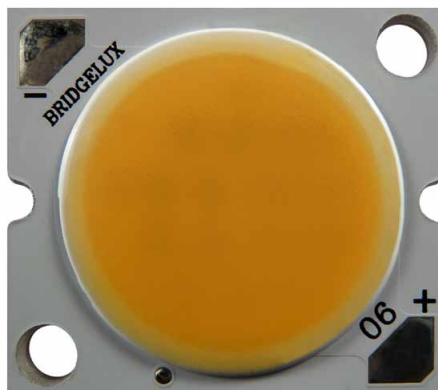

**Parallel to the power options extension of the high CRI Decor series for a luminous flux of up to 5000lm, Bridgelux also increases efficiency**

The Decor series now offers increased efficiency as well as a broader range of light sources - from 500 to 5000 operational lumens in three color temperatures, 2700, 3000 and 3500 K - to satisfy the increasing number of applications demanding very high light quality.

With a CRI of 97 and a 3-step MacAdam Ellipse color control option, the Decor arrays enable lighting designers to accurately render a full palette of colors over a wide range of light levels to create stunning and sophisticated lighting effects. The Decor series has been spectrally engineered to virtually replicate the light quality of halogen and incandescent light sources. These arrays deliver R9 and R15 values of 98, to both enhance reds and more accurately represent many skin tones, delivering clean and natural lighting. ■

## LED-Component Duris P 5 Sets Standards for Lifetime and Corrosion Stability

More and more frequently, luminaires in the professional sector are equipped with LEDs. This applies both for indoor and outdoor lighting solutions. In the process, luminaire manufacturers give particular importance to durable, efficient and high-quality LEDs.

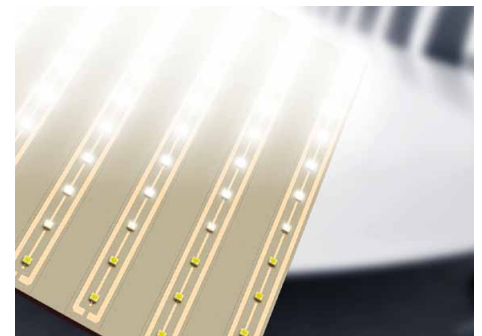

**Osram's new Duris P 5 provides high quality to area and linear luminaires**

Duris P 5 offers a luminous efficacy of up to 110 lm/W (CCT 3000 K) and an average lifetime of more than 50,000 hours, even at high currents and temperatures. Duris P 5 is the first of its kind on the market for medium-power classes with particular resistance to adverse environmental conditions. Long-term tests with corrosive gases such as sulphur or chlorine cause no harm to the LED, without inducing a significant luminous flux decrease. Nor did long-term tests under sauna-like conditions, with considerable temperatures and high humidity levels, have any adverse effect on the LED.

The new LEDs are ideally suited for linear and area luminaires. The Duris P 5 enables homogenous illumination without any noticeable individual points of light. As luminaires typically contain more than 100 mid-power LEDs, a low failure rate of the LEDs used is of particular importance to ensure a high luminaire quality throughout their lifetime.

LEDs are also exposed to corrosive influences when used indoors. These are induced, among others, by circuit board materials, rubber seals or adhesives. Hence, an increased resistance against corrosion provides an additional guarantee for the durability of professional lighting solutions. ■

## Osram OS Introduces Osram Ostar Stage

With their much flatter profile the new Osram Ostar Stage LEDs provide the basis for compact spotlights with an extremely narrow beam and high luminance. These LEDs are ideal for moveable stage lights, known as moving heads, which provide powerful light beams for rock concerts and other impressive lighting arrangements.

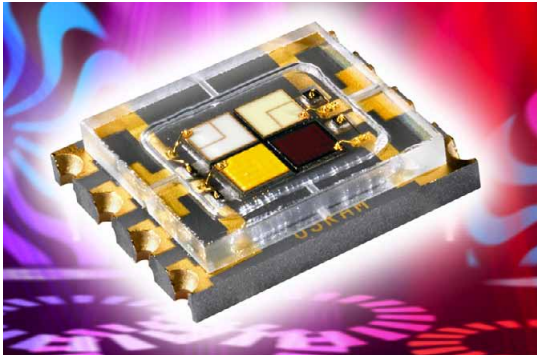

The new Osram Ostar Stage LEDs for bright spotlighting with color mixing

Instead of the usual lens, Osram Ostar Stage LEDs have a flat glass cover with an anti-reflective coating, giving the LED a much flatter profile. It is now only 1.23 mm high – one quarter of the usual height. Spotlights can therefore be made much more compact.

These powerful light sources are based on the successful Osram Ostar SMT platform and contain four different chips in red, green, blue and white. This means they can produce virtually any color. In pulse mode the individual chips can be operated on a current of up to 2 A, and up to 1 A in continuous mode. This gives maximum values of 146 lm in red, 234 lm in green, 1.3 W in blue and 286 lm in white. The overall brightness of an LED at a typical output of 10 W may be up to 700 lm. The dimensions of the LEDs are modest indeed, with a footprint of only 5.9 mm x 4.8 mm. At 3.1 K/W the thermal resistance is very low and heat removal is no problem at all. In constant use the LEDs will last for more than 50,000 hours, giving the moving heads a very long life. ■

## Cree Introduces New XLamp® ML-C and ML-E LEDs

Cree introduces new mid-power XLamp® ML-C and ML-E LEDs, bringing increased versatility and flexibility to a wide spectrum of lighting applications. The expanded XLamp ML family now offers red, green and blue color options, high-voltage and three different price-performance options in the proven and reliable ML package. The ML LED high-voltage options can enable the use of more efficient, smaller drivers to lower cost for applications such as LED replacement lamps.



With the new XLamp ML-C and ML-E, Cree increases the application options of this versatile XLamp LED series

# VSS VOSSLOH SCHWABE

Your new colleague  
at the office:

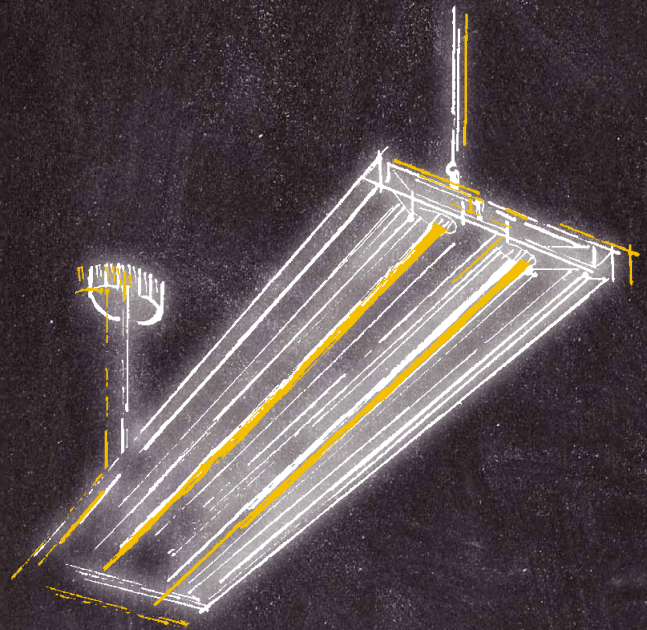

### LUGA Line LED Modules (COB) for Linear Lighting

- Long service lifetime 50,000 h (L90, B10)
- Narrow colour tolerance: 3 McAdams
- Highly efficient: 86 lm/W at  $t_j = 80^\circ\text{C}$
- Very low thermal resistance: Ceramic PCB

[www.vossloh-schwabe.com](http://www.vossloh-schwabe.com)

A member of the Panasonic group **Panasonic**

**Short Facts:**

- With this expansion, Cree's XLamp ML family now offers red, green and blue color options, high-voltage and three different price-performance options.
- The ML LED high-voltage options enable the use of more efficient, smaller drivers to lower cost for various applications.
- Delivering the flexibility and optimization needed to quickly design a portfolio of products, XLamp ML LEDs can be used for multiple lighting applications, including architectural, hospitality, emergency vehicle, decorative lighting and linear fluorescent LED replacements.

**One Footprint – Different Performance and Application Options:**

With a typical voltage of 6.4 V and 9.6 V respectively at 50 mA, the ML-C and ML-E series LEDs provide higher voltage options that can enable the use of more efficient, smaller drivers to lower cost for applications such as LED replacement lamps.

Minimum-80, 85 and 90 CRI options are available for all ML White LEDs to address applications, such as retail and restaurant lighting, where high CRI is required. ■

## Sharp Adds New Pico Zenigata to Zenigata Series

With the new Pico Zenigata LED series consisting of three versions, Sharp completes its portfolio for high-performance LEDs. All three series are available with a typical CRI value of 83. The high color rendering (HCR) LEDs achieve the high CRI level through a combination of blue LED dies with a special mixture of green and red phosphor.



Sharp's Pico Zenigata can be used for indoor and outdoor lighting, in applications such as commercial lighting, office lighting, replacement lighting, and specialty lighting

With just a single LED, the types of the GM2BBxxQK1C series achieve luminous flux levels of up to 24.5 lumens and an efficiency of up to 125 lm/watt. Luminous flux and efficiency of the other two series were improved accordingly: above all the GM2BBxxQKAC (2 LED dies) reaches up to 46.7 lumens with an effective power of up to 120 lm/W; the GM2BBxxQK0C (3 LED dies) radiate up to 72.5 lumens at an efficiency level of up to 120 lm/W.

The 'Pico Zenigata' series is available in three different shades of white. It starts with 'Warm White' (2,700K and 3,000K) and ranges to 'Natural White' (3,500, 4,000 and 4,500K), 'Pure White' (5,000K and 5,700) and "Cool White" with 6,500K. Typical application areas include ceiling lighting of office rooms and factories, sales area lighting, street lighting, architectural lighting and display lighting, light for energy-efficient lighting. ■

## Megaman® Launched TECOH® LED Module at Light+Building

Megaman® which leads the way in energy-efficient lighting brought its first OEM LED module range, TECOH®, to Light & Building 2012. An application-ready solution which can be simply adapted into existing luminaires, Megaman's TECOH® MHx and CFx ranges ensures ultimate flexible design for many years to come.



Megaman's TECOH® MHx (left) is intended to design TCH reflector equivalent solutions to replace 35W metal halide lamps, while the TECOH® CFx (right) allows the design of downlights that can replace 50W halogen and 2x13W and 2x18W compact fluorescent lamps

**TECOH® MHx:**

Building on the success of Megaman®'s intelligent TCH reflector solutions, TECOH® MHx uses a double axial mounted LED array and a unique patented thermally conductive base and head design to offer fixture manufacturers superb heat dissipation, lighting performance and lumen maintenance. The TECOH® MHx LED module occupies the same space as a G12 ceramic metal halide lamp, plus holder assembly, and has a similar light centre length offering a true alternative up to a 35W metal halide lamp. The lamp's design allows for effective beam control from existing reflectors.

**TECOH® CFx:**

Megaman®'s TECOH® CFx range of high performance twist-lock LED modules has an integrated driver for general lighting and is designed in line with proposed Zhaga specifications. With lumen packages of 1100 and 1800 lumens, Megaman®'s TECOH® CFx modules are ideal for use in downlights, replacing conventional light sources such as 50 W halogen and 2 x13 W and 2 x18 W compact fluorescent lamps. ■

## Bridgelux Introduces Zhaga Compliant Cetero Spot Light Module

Bridgelux Inc. announced the introduction of the Bridgelux® Cetero™ Spot Light Module (SLM) a compact high flux density light source delivering clean and consistent white light without pixilation and engineered to comply with the upcoming Zhaga spot light module specification.



At Light+Building 2012 Bridgelux presented the Zhaga compliant Cetero Module to the public for the first time

# WHAT HAPPENS IF YOUR LIGHTING SYSTEM FAILS?

Your driver is the heart of your lighting system. So it makes sense to choose one from a name you trust. Introducing the **GE Lightech™ LED Driver**. Effective, reliable and intelligent, the GE Lightech LED Driver enables you to create next-generation LED lighting systems that push the boundaries of performance and redefine efficiency.

Visit [GELighting.com/Lightech](http://GELighting.com/Lightech) to learn more.



imagination at work



3535 Ceramic Substrate Package  
 Warm White 3000K: 80 lm, CRI > 80  
 Cool White 5700K: 110 lm, CRI > 70

Structures and materials depend on demand of client.

## The Right LED for The Right Application

EVERLIGHT proudly presents Shwo D 1W Series which has distinctively compact size and brilliant brightness with high luminosity. EVERLIGHT always provides the best solution to fulfill your needs.

For further information please enter [www.everlight.com](http://www.everlight.com)

Please visit us during 2012 LED Lighting Taiwan

Date: June 19 - 21, 2012 |

Venue: Taipei World Trade Center Nangang Exhibition Hall |

Booth Number: M612 |

# EVERLIGHT

The Cetero SLM will offer light output ranging from 800 to 2300 lumens across multiple color temperatures all in one common form factor. Its mechanical compatibility with the upcoming Zhaga interface specifications will ensure interchangeability and a modular product platform that will expand luminaire design options for our customers.

Bridgelux is an active member of Zhaga, an industry-wide cooperation aimed at the development of standard specifications for the interfaces of LED light engines. The Cetero modules will be available in 2700, 3000 K, 3500 K and 4000 K CCT options - all providing a minimum 80 CRI and 3 SDCM color consistency and leveraging the production proven Bridgelux ES product family. Three lumen categories will be initially available, delivering operational lumens of 800, 1100, and 2000 lumens all in a common light emitting source area to enable compatibility with secondary optics. The Cetero SLM will be commercially available in late 2012. ■

## Cree Extends LMH2 LED Modules Series

LED lighting leader Cree, Inc., extends the high-performance LMH2 module family with new 2000 and 3000 lumen output options, delivering better performance, longer lifetime and lower system cost than comparable compact fluorescents in commercial lighting. The LMH2 module family now enables a wider range of lighting applications within a compact, cost-effective design.



**Cree's new LMH2 series is available with a flat or dome lens. Drivers are also available as optional heat sinks**

The LMH2 delivers 82 lumens-per-watt system efficacy combined with a CRI greater than 90 in all available color temperatures. The LMH2 LED features Cree TrueWhite® Technology that delivers high efficiency with beautiful light characteristics, while maintaining color consistency over the rated lifetime of the product. The LMH2 module family is available in a range of lumen, CCT (2700 K, 3000 K, 3500 K and 4000 K) and driver options, enabling lighting manufacturers to meet their needs quickly and easily.

The LMH2 module separates the light source and power supply to enable a wide selection of mounting and wiring options – giving lighting manufacturers the flexibility needed for rapid LED luminaire design and development. LMH2 modules also feature primary thermal management – potentially eliminating the need for costly secondary thermal management systems. The module is available with Digital Addressable Lighting Interface (DALI) and DALI touch dimming. ■

# Bringing the Power to Light™ with Simple HBLED Drivers

## High Brightness LED Drivers with High-Side Current Sense

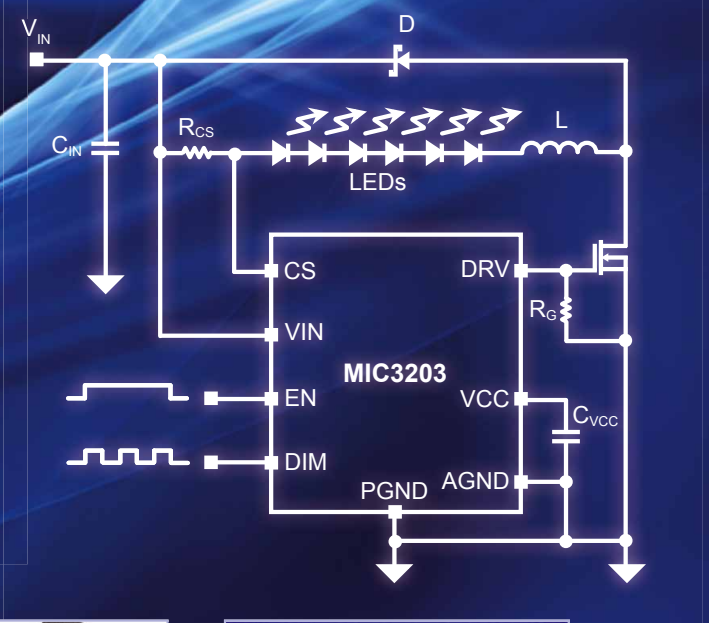
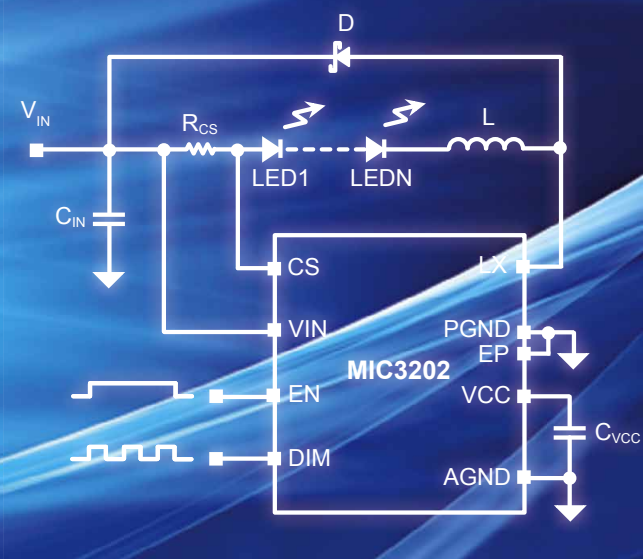

### Applications



The rapid growth of LED lighting applications in commercial, industrial and automotive markets has led to a wide variety of technical challenges for LED Drivers. Micrel is meeting these challenges with simple step-down LED Drivers such as the MIC3202 and MIC3203.

The MIC3202 is a hysteristic step-down LED Driver with integrated MOSFET capable of driving up to 10 HBLEDs with constant currents up to 1A in a thermally enhanced exposed pad SOIC-8L package.

The MIC3203 is a hysteristic step-down LED Driver with an external MOSFET capable of driving up to 10 HBLEDs with power levels up to 40W in a SOIC-8L package.

For more information, contact your local Micrel sales representative or visit Micrel at: [www.micrel.com/ad/leddrivers](http://www.micrel.com/ad/leddrivers).

### Ideal for use in:

- ◆ 12V Lighting Systems (MR-16 Bulb, Under Cabinet Lighting, Garden/Pathway Lighting)
- ◆ Architectural, Industrial, and Ambient Lighting
- ◆ LED Bulbs
- ◆ Indicators and Emergency Lighting
- ◆ Street Lighting
- ◆ Channel Letters

Part Number	Input Voltage	Output Current	PWM Dimming	Dithering	Package
MIC3202	6V to 37V	1A	Yes	Yes	EP SOIC-8L
MIC3202-1	6V to 37V	1A	Yes	No	EP SOIC-8L
MIC3203	4.5V to 42V	Controller	Yes	Yes	SOIC-8L
MIC3203-1	4.5V to 42V	Controller	Yes	No	SOIC-8L



[www.micrel.com](http://www.micrel.com)

## LED Mega Blockz for Commercial Installation

American Illumination's newest 4x4 Mega Blockz LED module is perfect for commercial indoor or outdoor applications where high lumen output and low energy use is required. It uses ultra-bright yet low power LEDs and packs a punch with an output of over 800 lm. The Mega Blockz exceeds the minimum 70 lm/W Energy Star efficacy requirement for solid state lighting.



**American Illumination's 4x4 Mega Blockz with its 800 lumens and at least 70 lm/W can be incorporated into different Energy Star compliant designs**

Mega Blockz is the cornerstone to a designer's palate of fixtures. It is perfect for both interior and exterior installations; the 4x4 Mega Blockz can be incorporated into sconces, indirect light sources such as hanging pendants, and some ceiling fixtures featuring a wide beam spread. Outdoors, it can be used in up lights, brick lights, signage or back lights, and general exterior lighting. ■

## Vexica Announces LUMAERA-50-RP

Vexica Technology has announced the launch of a new OEM LUMAERA LED module, a 50mm diameter LED module for integration into OEM luminaires.

The new LUMAERA-50-RP module gives luminaire manufacturers versatile LED solutions without the associated research and development costs in a form factor that is rapidly becoming the industry standard for small led light engines. LUMAERA uses proprietary technology, the latest LED technology and remote phosphor conversion providing both efficient and color consistency of light engines.



**Vexica's new LUMAERA-50-RP module was demonstrated in Frankfurt at Light+Building**

This 50mm module is designed to be integrated into LED down lights and other lighting products. The LUMAERA-50-RP uses an external LED driver and requires a secondary heat sink. (Available upon request) A 4-way connector provides the main feed to the module and additional connectivity for external emergency lighting controls. ■

## Verbatim Unveils OLED Modules for Dynamic Illumination

At Light + Building 2012, Verbatim unveiled the world's first color-tunable and dimmable OLED module that delivers brightness of up to 2,000 cd/m<sup>2</sup>. - Twice as bright as earlier devices.



**Apart from the current generation of OLEDs, Verbatim also presented the first samples of its next generation OLEDs which provide twice the efficiency and luminance**

Architects and interior designers can use OLED technology to create atmospheric lighting without hot spots, glare or uncomfortable intensity. At the show, Verbatim demonstrated how its latest VELVE OLED modules can be used to create dynamic wall illuminations.

Verbatim presented a new set of compact off-the-shelf modules, although the company can also create custom-made OLED panel sizes. One option measures 131 mm x 144 mm and the second is only 65 mm x 72 mm, a quarter of the original size. Both variants have a depth of only 5 mm. The profile of the OLED modules in this series has been made smaller, thinner and lighter because its printed circuit board is no longer rear-mounted and is housed in an electronic control unit connected via cabling.

The latest series of color-tunable VELVE OLED modules is ideal for mood lighting with each panel delivering red, green and blue (RGB) mixed color with illuminance of 2000 candelas per square meter at a color temperature of 3000 K. ■

## Tridonic Introduces New OLED Light Modules

At Light+Building 2012 Tridonic showcased the next generation of lighting in the form of organic light emitting diodes. The OLED modules offer uniform light and an extremely low profile and represent the perfect interplay between optics, mechanics and electronics.

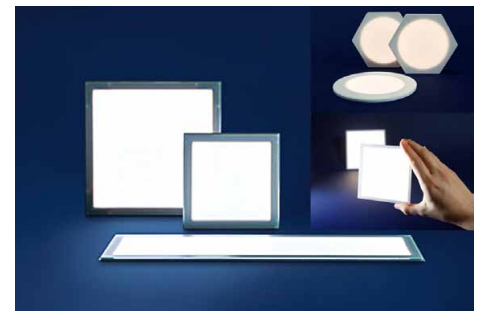

**Tridonic's new OLED modules named LUCEOS ROP, LUREON REM and LUREON REP were officially launched at Light+Building**

The LUCEOS ROP series is ideal for decorative lighting applications and offers enormous flexibility. This integrated OLED module is available in HEXAGONAL and ROUND versions. The integrated driver electronics provides for simple and flexible integration in numerous lighting applications. The dimmable modules produce a pleasant warm white light with excellent color rendering. LUCEOS ROP OLED modules are equipped with a magnetic holder which makes them easy to install and replace.





## Thermal Conductive Plastic Semi-Module



MR11 MR16 Bulb PAR38 PAR30 AR111 T8

**Ledlink Optics** has developed a whole new semi-module series which is more eco-friendly, economical, and high efficient than conventional series. In this new series, we produce heatsink by plastic injection technique with special plastic material which has superior thermal dissipative characteristic. Besides impressive appearance, this heatsink has characteristics of light weight, thermal radiation to emit heat, more thermal dissipation surface and high thermal-conductive coefficient. Compared to conventional metal heatsink, this new heatsink can lower cost and raise production efficiency due to high plasticity of material.

## Thermal Conductive Plastic Semi-Module



Plastic heatsink can be a substitute for aluminum heatsink.



Heat is conducted through thermal radiation without medium  
Heat can even transmit in the vacuum condition.



The whole module is assembled with screws and internal fixing structures. And the module can be re-assembled.



Wider surface of this new heatsink, adding the efficiency of thermal radiation.



Plastics have high fluidity and can be formed as various shapes.



High plasticity provides efficient productivity at lower cost.



20%-45% lighter weight than aluminum.



AR111 Series



MR16 Series



PAR Series



BULB Series



The dimmable modules in the LUREON REM product series are characterized by an extremely low profile of less than 2.5 mm. The benefits of OLEDs are apparent in stylish designer luminaires or unobtrusive area light sources. Tridonic offers this OLED module system in QUADRATIC and RECTANGULAR versions. Their use as lighting applications is made easier by combining them with an adaptive driver system.

The LUREON REP OLED modules are efficient OLEDs for professional high-performance lighting applications. The LUREON REP series with the quadratic design represents an integrated OLED module system with first-class product characteristics. The system offers high luminance and efficiency. The optimized diffuse output optics contribute to the high performance of the light module. LUREON REP modules are used wherever uniform professional-level light is required. Here, too, adaptive driver systems are used to ensure smooth integration. ■

## Intematix Introduces ChromaLit XT Remote Phosphor

Intematix, a leading innovator of patented phosphors and phosphor components for high-quality LED lighting, recently announced the release of ChromaLit XT, the latest product in the award-winning ChromaLit™ line of remote phosphor technology.

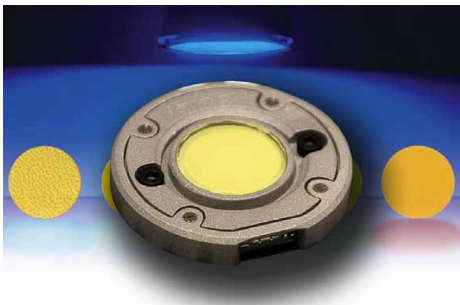

**Vexica's LUMAERA-50 is one of the first products that is based on the new Intematix XT remote phosphor system**

ChromaLit offers glare-free, diffuse light, high color rendering and consistent light quality. By only using a blue LED engine instead of binned white LEDs, production is streamlined and inventories are reduced. Furthermore, system efficacy is increased up to 30%, reducing power consumption.

ChromaLit XT offers a powerful and elegant solution for new applications like spotlights and floods, extending ChromaLit technology's light quality and adding higher light intensity, 65% lower cost per lumen and enhanced off-state neutral color when compared to conventional remote phosphors that are yellow in color. ChromaLit XT were on display for the first time at the Light+Building trade fair in Frankfurt, Germany from April 15-20.

ChromaLit XT can also be used to make lighting better outdoors and meets UL standards and is offered in a wide range of CCT and CRI options. ■

## Khatod Presents LYRA Optical Reflector Systems

At Light+Building Khatod showcased its most recent reflectors for COB LEDs. The Zhaga conform Lyra can boast an excellent optical efficiency based on the latest cutting-edge vacuum coating technology. They generate a homogeneous flux which is distributed on the inner surface.

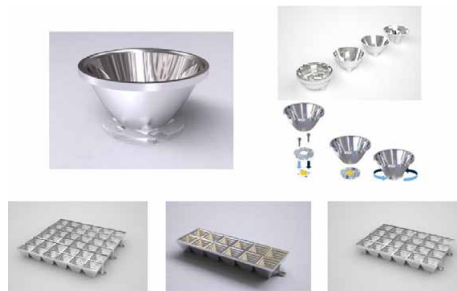

**Khatod's two new reflector products, the Zhaga conform LYRA (on top) and the PIXEL (below) were highlights at the Light+Building 2012**

The most recent developments in LED Technology have produced new devices such as the COB LEDs – Chip On Board LEDs - which allow many diverse LED configurations never considered before. COB LEDs which spread the light up to 140° and more will optimize their performance by using a reflector.

The high luminosity of the COB LEDs needs specific reflectors able to deliver an optical performance level perfectly complying with their optical efficiency requirements.

The newest reflectors from Khatod can boast an excellent optical efficiency based on the latest cutting-edge vacuum coating

technology. Made of special PCHT for vacuum coating treatment specific for optical reflector systems, they generate a homogeneous flux which is distributed on the inner surface. The result is an excellent luminous flux and high lighting efficiency.

Khatod Optical Reflector Systems comply with Zhaga Standards and fit most of the applications where COB LEDs are required. ■

## LEDiL's New RITA-A - Asymmetric Reflectors

LEDiL announces its latest product addition, the RITA-A reflector family, incorporating a unique optical design that further extends LEDiL's asymmetric secondary optic expertise for lighting class LEDs.

Currently qualified LEDs include Cree's XLamp® LEDs and Philips Lumileds LUXEON® Rebel and LUXEON® M LEDs. The offset design of this 17.1mm tall reflector neatly projects a rectangular beam of energy-efficient LED light with peak intensity in a forward offset 80° from the solid-state light source. The 28.4 x 36 mm<sup>2</sup> reflector cup is mounted to a 22 mm base.



**LEDiL RITA-A's main advantages compared to TIR lenses are the lower weight and the high temperature rating due to the material used**

LEDiL's designers envision indoor use of RITA-A. Works of art or museum pieces are easily illuminated without the need to tilt the lamp body and the reflector is easily rotated to provide extra accent where needed. RITA-A can illuminate long walls with minimal hot-spots or shadowing.

RITA-A does not require metallization to achieve high light transmission efficiency and the design enhances thermal flow within the fixture to help regulate thermal efficiency of the lighting system. The product is rated for use up to 115°C and meets UL 94 V-2 flammability rating. ■

THIS IS NOT AN LED —  
THIS IS LIGHTYEARS AHEAD.



The new Acrich2 boards are the perfect LED solution for general illumination applications, e.g. the replacement of conventional light bulbs. Characterised by their long life and low energy consumption, they can be connected directly to alternating current. With an output of 4 W to 16 W they can also replace MR 16 halogen lamps and recessed spotlights in addition to light bulbs.

Further properties:

Energy efficiency higher than 90%, power factor greater than 0.95, THD less than 25%, dimmable, no noticeable flickering.

**Better Be Bright.**  
[www.betterbebright.com](http://www.betterbebright.com)



**SHOWIN LED LENSES**

**HIGH PERFORMANCE LED LENSES  
STANDARD and CUSTOMIZED**

Custom Specific Designs

Compact Size Ø11mm

Designed for  
**OSRAM**  
Opto Semiconductors  
**CREE**  
**PHILIPS LUMILEDS**

Cluster Lenses

Symmetric  
Asymmetric

**GET YOUR FREE SAMPLES NOW**  
showin.illumino.com  
showin@illumino.com

## Linear Technology's New LED Controller Offers Input & Output Current Sense

Linear Technology announces the LT3796, a 100 V, high-side current sense DC/DC controller designed to regulate a constant-current or constant-voltage that is ideal for driving high brightness (HB) LEDs. Its 6 V to 100 V input voltage range supports a wide variety of applications, including automotive, industrial and architectural lighting. The LT3796 uses an external N-channel MOSFET and can drive up to 85 V of white LEDs from a nominal 12 V input, delivering in excess of 50 Watts.

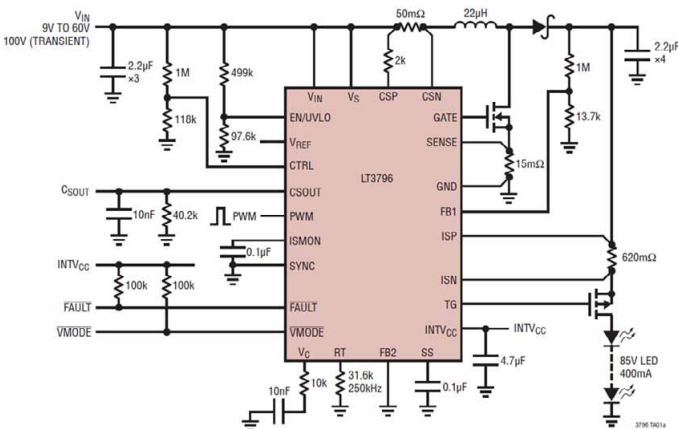

Typical application circuit of Linear Technology's new LT3796 driver that can handle input transients of up to 100V

The LT3796 can deliver efficiencies of over 94% in boost mode, minimizing the need for external heat sinking. A frequency adjust pin enables the user to program the frequency between 100 kHz and 1 MHz, optimizing efficiency while minimizing external component size and cost. Combined with a thermally enhanced TSSOP-28 package, the LT3796 offers a highly compact HB LED driver or charger solution.

# CIOE CHINA INTERNATIONAL OPTOELECTRONIC EXPO

## THE WORLD'S LARGEST EXHIBITION FOR OPTOELECTRONICS

### THE 14<sup>TH</sup> CHINA INTERNATIONAL OPTOELECTRONIC EXPO

# LED EXPO

**SEPTEMBER 6-9, 2012**

SHENZHEN CONVENTION & EXHIBITION CENTER • CHINA

CONCURRENT  
EVENTS



OPTICAL  
COMMUNICATIONS  
EXPO



LASERS & INFRARED  
APPLICATIONS  
EXPO



PRECISION  
OPTICS  
EXPO

CONCURRENT  
CONFERENCE



CHINA INTERNATIONAL  
OPTOELECTRONIC CONFERENCE

FOR MORE INFORMATION, PLEASE VISIT:

**WWW.CIOE.CN**



CHINA INTERNATIONAL OPTOELECTRONIC EXPOSITION OFFICE

Add: Room 607, East Block, Coastal Building, Haide 3rd Road,  
Nanshan District, Shenzhen, Guangdong, 51 8059, China  
Tel: +86 755 8629 0891 Fax: +86 755 8629 0951  
E-mail: international@cioe.cn



# Exterior Featured LED Products



- ① Garden Light HL012
- ② Wall Washer XL-018
- ③ Wall Light WW-018
- ④ Inground Lamp MD-018
- ⑤ Wall Washer XL-150

Address: Yijia Industrial Park, Fuqian Road, Guanlan Town, Baoan,  
Shenzhen, Guangdong, China

Tel: +86-755-28093844 Fax: +86-755-27608651

[Http://www.signcomplex.com](http://www.signcomplex.com)

E-mail: [info@signcomplex.com](mailto:info@signcomplex.com)



The LT3796 uses True Color PWM™ dimming, which delivers constant LED color with dimming ranges of up to 3,000:1. For less demanding dimming requirements, the CTRL pin can be used to offer a 10:1 analog dimming range. Its fixed frequency, current-mode architecture ensures stable operation over a wide range of supply and output voltages. Robust open and short-circuit protection maximize overall system reliability. Additional features include frequency synchronization, programmable UVLO and a programmable fault restart timer. ■

## New Single Stage Off-Line LED Driver IC Series from Allegro

Allegro MicroSystems, Inc. introduces the LC5540LD/LF single stage power factor corrected off-line LED driver IC series which is manufactured and developed by Sanken Electric Co., Ltd. in Japan.

The robust functions within these single stage converters have been developed to simplify system designs. This new series is targeted at the consumer and industrial markets targeting indoor and outdoor LED lighting and off-line LED lighting applications.

The LC5540LD/LF series are quasi-resonant topology switching power supply ICs, designed for input capacitorless applications making it possible for systems to comply with the harmonics standard (IEC61000-3-2 class C). These devices incorporate separate controller and power MOSFET chips. The controller adapts the average current control method for realizing high power factors, and the quasi-resonant topology contributes to the high efficiency and low EMI noise.

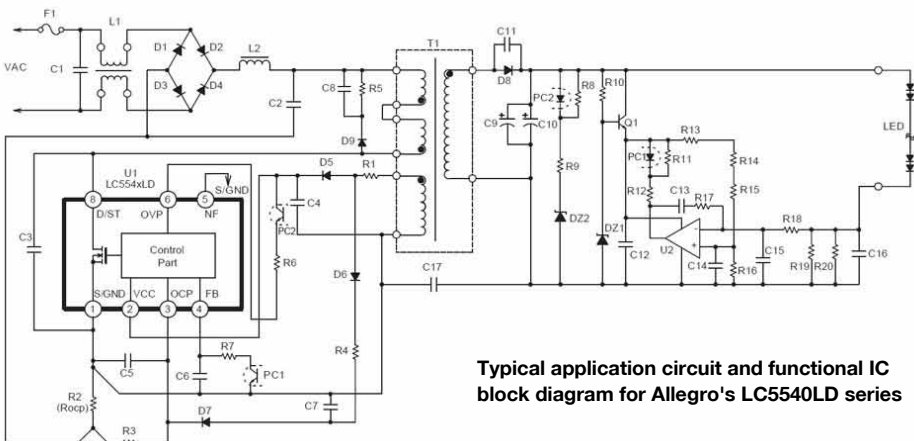

**Typical application circuit using the CL8801 which has four current regulator outputs**

**Typical application circuit and functional IC block diagram for Allegro's LC5540LD series**

This series is available in the DIP8 and TO220 packages that have been designed to protect the IC and overall system from excessive heat. Competing designs cannot easily detect the power MOSFET rising temperatures. ■

## Supertex's New CL8800 & CL8801 Sequential Drivers

Supertex introduced CL8800 and CL8801, sequential, linear LED drivers designed to drive long strings of low cost, low current LEDs in solid-state replacements for fluorescent tubes, incandescent bulbs and CFL bulbs. Both ICs minimize driver circuit component counts, requiring just four or six resistors and a diode bridge. Two to four additional components in the circuit provide transient protection, and neither capacitors nor magnetic components are required. Because the ICs are multi-stage linear current regulators, there are no high frequency switching currents and, thus, no need for a front-end EMI filter. CL8800 is intended for 230 VAC, while CL8801 is for 120 VAC input.

### Applications:

- Fluorescent tube retrofit
- Incandescent & CFL bulb replacement
- General LED lighting

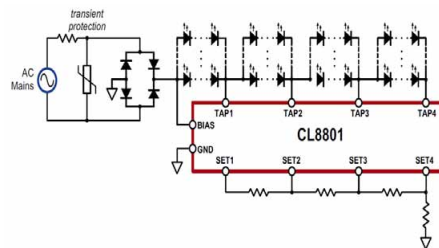

CL8800 has six current regulator outputs and CL8801 has four. These outputs tap a string of series parallel LEDs, and the regulators sink current at each tap and are sequentially turned on and off automatically, tracking the input sine wave voltage. Voltage across each regulator is minimized when conducting, providing typical efficiency of greater than 90%. Output current at each tap is individually resistor adjustable. The current waveforms of both ICs can be tailored to optimize for input voltage range, line/load regulation, output power/current, efficiency, power factor, THD, dimmer compatibility and LED utilization. Both ICs are compatible with phase dimming with the addition of an RC network. ■

## Cirrus Logic Enters Lighting Market with Digital LED Controller

Cirrus Logic is entering the LED lighting market with a digital LED controller that directly solves dimmer compatibility issues that have been a major barrier to consumer adoption of LED retrofit bulbs. Featuring Cirrus Logic's digital TruDim™ technology, the CS161X controller family has been tested to provide near 100 percent compatibility with a wide array of dimmers representing the vast majority of the installed base worldwide.

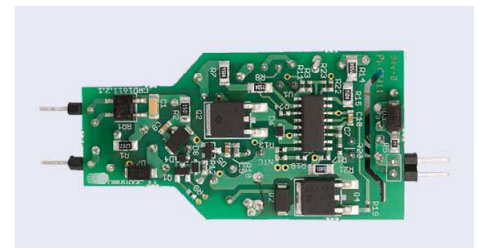

**Cirrus Logic, newcomer in the SSL driver market, claims 98% compatibility with TRIAC dimmers for its CS161x LED drivers**

The CS161X family enables industry-leading dimmer compatibility as a result of a three-year investment in TRIAC interface algorithms, LED driver topologies and system architecture, which are the foundation of TruDim technology. The CS161X's digital intelligence allows the controller to identify the type of dimmer in use and adapt its dimmer compatibility algorithm to provide smooth dimming in much the same way the consumer has come to expect from decades of using incandescent light bulbs. This smart adaptive digital signal processing technology is not possible with today's analog controllers. ■

Over 10,000 LEDs & LED lighting components and solutions available, including design resources, application notes and technical support. Farnell element14 is your single source solution for all your LEDs and LED Lighting component needs.

# BRIGHT IDEAS START HERE

AVAGO  
TECHNOLOGIES

BRIDGELUX

CREE

MICROCHIP

TE  
connectivity



TEXAS  
INSTRUMENTS

XP



element14

[farnell.com/lighting](http://farnell.com/lighting)

## New JENCOLOR ICs for Photometry at the Light & Building 2012

At Light & Building 2012 MAZeT GmbH unveiled two new ICs for the target application of LED light control. The JENCOLOR MTCSiCF color sensor in its space-saving QFN16 housing (4 x 4 x 0.9 mm) provides colorimetry in accordance with the CIE1931/ DIN5033 standard. The sensor outputs send photocurrents and can be directly integrated into LAB/LUV color spaces as XYZ values.

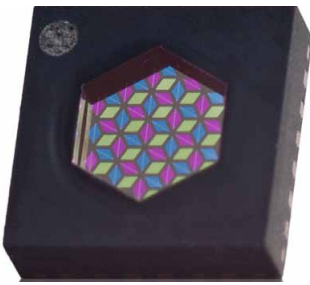

MAZeT's new color sensor MTCSiCF for photometry is placed in a newly designed housing

The sensor consists of photodiodes whose spectral sensitivity curves are achieved using interference filters. These filters do not exhibit any demonstrable aging or temperature drift.

The second IC handles signal processing and was specially designed for the three-range JENCOLOR color sensors. The MCDC04AQ features an ADC whose resolution can be varied over the integration time. The highest resolution is 16 bits and is achieved at an integration time of 1 s. The highest sensitivity is at 20fA/LSB. The MCDC04AQ also offers the option for external synchronization of the measuring process. It is internally temperature-compensated.

The combination of color sensor MTCSiCF with MCDC04AQ is excellently suited for photometry applications (brightness, color and temperature), for determining current values for control of spectrally mixed LED light sources or as sensors for monitor calibration for flat displays with LED backlighting. In addition to JENCOLOR sensor IC products, MAZeT also offers evaluation kits and application support. ■

## TAOS Ambient Light Sensor for Daylight Harvesting

Chipmaker austriamicrosystems introduced its TAOS TSL4531 ambient light sensor device family at the Light+Building exhibition, which enables sophisticated daylight harvesting for intelligent lighting systems and luminaires.

The sensor family offers a wide sensitivity range from 3 lux to 220,000 lux, preventing saturation even in direct sunlight, while implementing a photonic response model that spectrally matches light perception in the human eye.

The TSL4531 ambient light sensor provides a simple direct lux output and a 16-bit digital interface. Sophisticated filters automatically reject the 50-60Hz ripple typically produced by a building's fluorescent lighting systems, enabling the sensed light levels to more accurately measure the daylight that is entering the building.



**Exclusive Made in Taiwan**  
Professional High Power LED Makers



June 26~29, 2012

welcome to visit us in KINTEX, Korea

Booth No. **E-07 in Hall 3**

No. 89, Xiyuan Rd., Zhongli City, Taoyuan County 320, Taiwan (R.O.C)  
TEL: +886-3-461-8618 FAX: +886-3-461-8677  
E-mail: sales@prolightopto.com <http://www.prolightopto.com>



## Intelligent Daylight Sensing



**TAOS/austriamicrosystems new TSL4531 features a spectral sensitivity that resembles the human eye and allows sophisticated daylight harvesting**

User selectable integration times (100 ms, 200 ms, 400 ms) along with a wide dynamic range translate into a very versatile system. ■

## Nuventix Launches New SynJet Coolers

From the Light + Building 2012, Nuventix announced four new of SynJet coolers for LED lights: the Wall Wash Cooler 77 W, Outdoor Cooler 70 W and 77W and Spotlight Cooler 57 W.



**Nuventix claims the new Spotlight Cooler 57 W to be the quietest SynJet thermal management solution ever developed**

The Nuventix Wall Wash Cooler 77W is the first ever SynJet with a rectangular form factor, designed specifically for wall wash luminaires, tracklights, and floodlights and provides up to 77 watts of cooling.

Designed to meet the demanding requirements of outdoor lighting, the Outdoor Cooler 70 W and 77 W SynJet solutions enable outdoor LED lighting up to 8,000 and 6,000 lumens, respectively. These solutions are modular and can be combined to achieve lumen outputs over 15,000 lumens. From extreme temperatures, to rain and humidity, to dust and salt fog, Nuventix' outdoor coolers have been designed to withstand mostly anything nature can throw at them.

The Spotlight Cooler 57 W enables up to 3000 lumens for tracklights, downlights and recessed adjustable downlights. With a SynJet that sits on top of the LED heatsink, not in it, the unique design makes this the quietest SynJet thermal management solution ever developed. ■

## CarbAI™ for Cost-Effective High Quality Cooling

Applied Nanotech has unveiled an improved passive thermal management material called CarbAI™, a carbon-based material with a unique combination of low density, high thermal diffusivity, and low coefficient of thermal expansion.

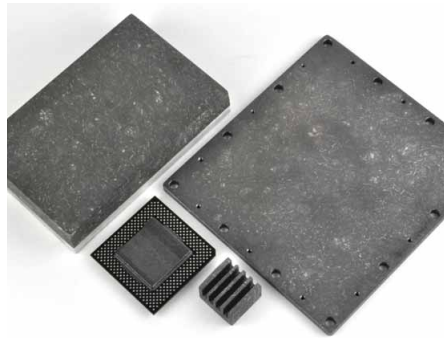

**These are just a few product examples. CarbAI™ can be provided with custom dimensions and shapes needed for customer specific applications**

CarbAI's unique attributes allow it to exceed the capabilities of thermal management materials, like copper and aluminum.

CarbAI™ has a density of 1.75 g/cm<sup>3</sup> compared to 2.7 g/cm<sup>3</sup> for aluminum and 8.9 g/cm<sup>3</sup> for copper. While copper has a slightly higher thermal conductivity than CarbAI™, 390 W/mK compared to 350 W/mK, its thermal diffusivity is approximately 2.9 cm<sup>2</sup>/sec compared to 0.84 cm<sup>2</sup>/sec for aluminum and 1.12 cm<sup>2</sup>/sec for copper, and CarbAI™ has a superior CTE and is cost competitive.

CarbAI™ can be electroplated with nickel-boron, gold, nickel, and copper. In addition, soldered copper or aluminum plates can be added for increased strength and stability. The ultimate example of CarbAI™ contains a dielectric layer and full circuit trace functionality as a PCB replacement with integrated thermal management. ■



## Edge Lighting Technology for Superior Illumination

Custom Downlight Assemblies



Range of Color Temperatures



Custom Molded Lighting



Directional Lighting



+1-440-922-4584  
info@glthome.com  
www.glthome.com

# EBV LIGHTLAB

## New Ways to Create Your Individual World of Light

EBV Elektronik is the leading specialist for optoelectronics in EMEA semiconductor distribution and also the first company to provide customers all over Europe with access to a light laboratory.

In the EBV LightLab at its headquarters in Poing, Munich, the EBV LightSpeed team offers customers the opportunity to perform radiometric and photometric measurements across the entire light chain: from individual LEDs or LED modules, through

comparative measurements of light sources, e.g. light bulbs versus CFL or LED solutions, right up to the complete measurement of entire luminaires. This will give even the smaller companies access to exclusive, high-precision measuring technologies.

For more information simply contact your local EBV LightSpeed team or check us out at [ebv.com/lightlab](https://www.ebv.com/lightlab).

DISTRIBUTION IS TODAY. TOMORROW IS EBV.

**EBV** *LightSpeed*



**EBV**Elektronik  
| An Avnet Company |



# Light+Building Review – Zhaga Standard, High Quality Lighting & OLEDs

A report made by LED professional's chief editor, Arno Grabher-Meyer, provides insights into new developments, products and trends presented by the key players in the component business at Light+Building 2012 in Frankfurt.

Some 196,000 visitors, compared to 183,111 in 2010 (an increase of seven percent), made their way to Frankfurt for Light+Building 2012 from April 15<sup>th</sup> to 20<sup>th</sup>. It is the world's biggest trade fair for lighting and building services technology. At the fully booked Frankfurt Fair and Exhibition Centre, 2,352 manufacturers (compared to 2,154 in 2010), from 50 countries presented their latest products and trends from the fields of lighting, electrical engineering, home and building automation and software for the construction industry. The increase in the number of visitors comes equally from home and abroad. The proportion of international visitors rose to 44 percent, which means that almost every second visitor came from outside of Germany.

"Accounting for 40 percent of the total, buildings are the world's biggest consumers of energy and, therefore play an important role for smart grids and decentralized energy supply. The very good result shows the extent of worldwide demand for environmentally friendly light and building-services solutions – and that Light+Building is the foremost meeting place for the industry and decision makers. As we learnt in many discussions during the fair, the results exceeded the sector's expectations", said Wolfgang Marzin, President and Chief Executive Officer (CEO) of Messe Frankfurt.

The economic outlook in the sector is seen in a very positive light. 91% of visitors and 83 percent of exhibitors are satisfied with the economic situation. After Germany, the ten leading visitor nations at Light+Building 2012 were The Netherlands, Italy, France, Austria, China, Great Britain, Switzerland, Belgium, Sweden and Russia. There was significant growth in numbers from North and South America as well as Asian countries such as India, South Korea and Japan. The visitor structure remained more or less unchanged with the main groups coming from the installation trade, industry and trade, as well as light planners, architects and engineers.

The top subjects in 2012 were "Digitalization of lighting and buildings" and "Buildings as green power stations". Trade visitors found the entire spectrum of lighting and building-services technology, as well as subjects ranging from LEDs, OLEDs and photovoltaic systems to decentralized electricity usage via e-mobility, smart metering and smart grids.

Visitor interest was split evenly between lighting technology and building-services technology. 98 percent of the visitors were satisfied with the range of products and services seen at the fair. The average time spent by visitors at the fair was two days. The poll of exhibitors produced an equally good result: 86 percent of them said they had achieved their goals for the fair.

## Supporting Program

This year, for the sixth time, the Luminale, a major side event of Light+Building, offered trade-fair visitors and residents a really unique spectacle. 160 lighting installations in and around Frankfurt immersed the city in a completely new ambience in the evening hours.

The Luminale took place at various locations in and around Frankfurt, and participating cities included Aschaffenburg, Mainz, Offenbach and Darmstadt. The main focus, though, was on Frankfurt with around 100 lighting events and Offenbach with approximately 40. International lighting artists transformed streets, tower blocks, churches, facades and museums into illuminated works of art during the evening and at night.

Numerous conferences and meeting opportunities completed Light+Building as the world's most important lighting event. One remarkable meeting was the ISA 2012 Working Meeting which was combined with a seminar session. ISA is an NGO and alliance of regional alliances, universities, institutions and leading companies with 54 members and the aim to foster sustainable development of SSL. One of ISA's key objectives is a dialogue on standards & testing of SSL products and a global cooperation in SSL research. Another organization, Zhaga, was also present at Light+Building for the first time. Zhaga was founded in February 2010 as an



**Figures 1-3:**

160 light installations were presented at the Luminale. Osram and its subsidiary Traxon Technologies presented OVO, a multi-sensory art installation made of an ovoid wooden sculpture magnified by light (top left). Zumtobel supported the implementation of an interactive space for light and sound on a container ship (right). Lukas 185 – 200 Metre Strength Tester was installed by the Multivision Anzeigensysteme GmbH (bottom).  
Credits: Messe Frankfurt Exhibition/  
Jochen Günther



**Figure 4:**  
Artistic light installations were not limited to the Luminale, sometimes the booths at the show, like Megaman's "Reflector Stand" had a touch of artwork as well

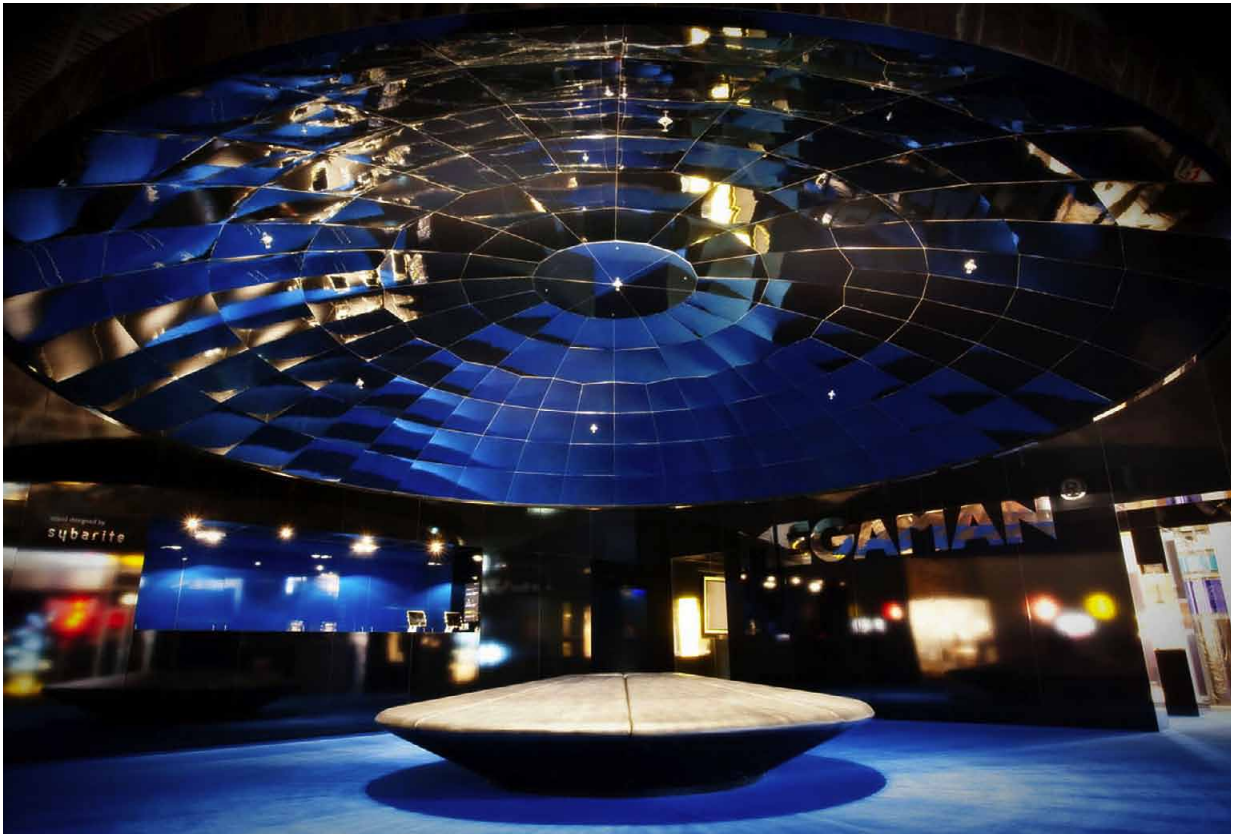

**Figure 5:**  
At the Zumtobel booth another piece of art, the "eL" from Daniel Libeskind, represented the Big Bang and the expansion of the universe



industry-wide cooperation between companies aimed at enabling the interchangeability of LED light sources made by different manufacturers. With the release of the 7<sup>th</sup> Book in April, the physical interfaces for the most important lighting applications are proposed. The first Zhaga certified products, most of them Book 2 & 3 compliant, could be found or were announced at the show.

### The First Impression

Compared to 2010, the number of LED related products increased drastically. Whereas in 2010 it was necessary to look for the highlights in several halls and on several application and integration levels, this year, it was impossible not to miss a highlight. Just trying to get a look at all the interesting and relevant products in Hall 4 proved to be a "Mission Impossible." As a consequence it was necessary to focus on a limited number of highly innovative companies, well known trend setters and the big players.

### Europe's Big Players - Setting Lighting Trends

Osram with its luminaire branch Siteco acquired in 2011, and Traxon/e:cue, Philips and Zumtobel displayed luminaires for applications from office lights to home and hospitality lights, industrial and sports facilities lighting and street lighting. There were also a very high number of shop lighting products for different shop types on display. Shop lighting has become an affordable application since the last Light + Building with all of the improvements in efficiency, light quality and price decreases of LEDs and components.

**Figure 6:**  
Zumtobel's  
IYon series LED  
luminaires for  
shoplighting

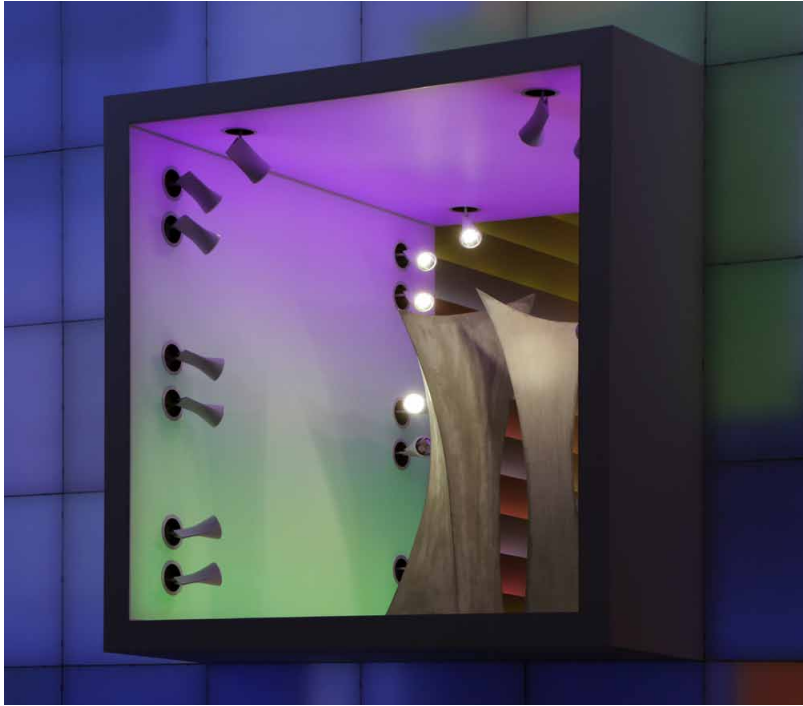

**Figure 7:**  
LED optics of a  
luminaire using Osram's  
Duris P5



**Figure 8:**  
The "UrbanSky"  
is just one of  
Philips' answers  
to the question of  
intelligent lighting  
solutions for cities



Zumtobel featured its tunable white technology with the IYon series LED luminaires. The luminaires can be tuned between 2700 K and 6500 K, offering over 2000 lm at an efficiency of more than 57 lm/W with a CRI of at least 90. In the same series there are also non tunable versions available. If a CRI of 80+ is sufficient for an application efficiency of up to 77 lm/W can be achieved. In addition, Zumtobel also presented the "Libeskind-Luminaire", designed by the artist Daniel Libeskind. This extraordinary eye-catcher, piece of art stands for Zumtobel's understanding of light, not only as a source of brightness, but also as a design element. Jürg Zumtobel, Chairman of Zumtobel AG's Supervisory Board, said: "Lighting experiences always represent a piece of culture, a piece of art, a piece of people's way of life. This is particularly true wherever light has emancipated itself from any functionality, leaving its mark on architecture and space as an independent work of art."

Osram featured its "Brilliant Mix" system in several applications as well as its Parathom lamp series. The "Brilliant Mix" technology promises a high CRI without sacrificing efficiency and is especially useful for high quality lighting applications like shop lighting. Furthermore the Red Dot awarded LED-Imageprojektor Kreios was on display. Street lighting, especially based on the new robust Duris P5 with its extraordinary corrosion stability was another issue, also showcased in several application examples. Furthermore, Osram's first COB LED, the Soleriq E, and the improved and now Zhaga compatible PrevaLED Core Eco P2 Modules were set in the scene.

Philips followed three mottos at Light+Building, "Intelligent Lighting Solutions for Cities", "Delivering Great Quality Light" and "Lighting Design Innovation", demonstrated by practical examples. The recently introduced and in a first project applied UrbanSky was only one example for street lighting out of the whole product range. For shop lighting, as an example for quality lighting, luminaires with 2700 K or 4000 K white, 3 solid colors (red,

**Figure 9:**  
16 international  
"LED Light for  
You" partners  
demonstrated how  
they develop  
individual,  
precisely tailored  
LED light solutions



green, blue), as well as a Tunable White and RGB were demonstrated, featuring the Fortimo module range from DLM to SLM, Disk and Decorative series. Like all other renowned luminaire and LED module manufacturers, Philips also presented products with a high CRI of up to 96. Visitors looking for retrofit lamps could experience the incandescent like dimming of the MASTER LEDspot 7-50 W GU10 dimtone and a new design line of LED bulbs.

### The Epicenter of LED Technology - Hall 4

According to Philips, lighting accounts for 20% of global electricity use, while public spaces and commercial buildings alone represent 60% of lighting-based electricity use. A full switch to the latest LED lighting would provide energy savings of up to 80% in many applications, and an average of 40% for all lighting. LED technology also offers unprecedented possibilities to digitally controlled light, for creating intelligent and dazzling light

experiences, the company said. It was therefore no surprise that Halls 4.0, 4.1 and 4.2, which traditionally host components for lighting technology and accessories as well as LEDs and technical lighting and lamps, was again the Mecca for LED experts from all over the world. All of the important LED manufacturers, most driver IC manufacturers and electronics suppliers as well as many optical material suppliers, optics manufacturers and thermal management suppliers displayed their products there.

**Figure 10:**  
Distributors like  
Future Lighting  
demonstrated  
their strength in  
supporting clients  
by their effort to  
generate solutions





We bring quality to light.



Putting LEDs in the right light.

**SSL solutions from the world leader in LED measurement**



Instrument Systems set the benchmark in LED testing with high-performance spectroradiometers for photometric and colorimetric measurements. Now we present another breakthrough in Solid-State Lighting with our new goniophotometers and integrating spheres.

Find out more about our innovations for SSL:  
[www.instrumentsystems.com/ssl](http://www.instrumentsystems.com/ssl)

 **Instrument  
Systems**  
light measurement

**Figure 11:** Most LED and module manufacturers not only presented their products, but also showed the application, as seen here at the SSC booth

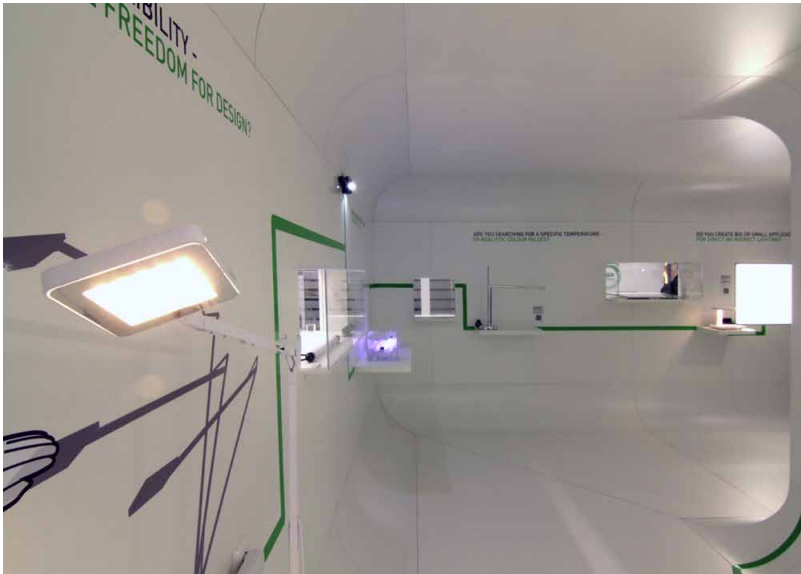

**Figure 12:** b,a,g, presented one of the first Zhaga Book 7 compliant LED modules



**Figure 13:** Aurista from Trilux is one of the first LED troffers that takes advantage of a Zhaga Book 7 compliant module



## LEDs and Modules

Most of the renowned LED and array LED and module manufacturers like Avago, Bridgelux, Citizen, Cree Edison Opto, Everlight, GE, Nichia, Seoul Semiconductor, Sharp or Toshiba could be found here on one of the three exhibition floors.

At the Cree booth the new SC<sup>3</sup> Technology Platform was a central topic. With this new technology Cree switches over from using a few big LED chips to a greater number of smaller, very closely packed LED chips in their packaged X-Lamp products. With this change, higher efficiency and luminous flux was achieved without sacrificing other proven qualities of the X-Lamp series like narrow MacAdams binning options. In contrast to other manufacturers, Cree seems not to have entered the Zhaga module business directly. They decided to support their clients in their effort to design Zhaga compliant products.

Other manufacturers decided to provide Zhaga compatible modules themselves; for instance Philips, Osram, Citizen, Everlight, LG, Toshiba, Vossloh-Schwabe or Tridonic showed up with a range of Zhaga compliant products which were specified in the Books 2 to 6. b,a,g, electronics for instance even demonstrated a Book 7 module and Trilux a luminaire based on such a module.

Bridgelux was on stage with the Zhaga Book 3 compliant Cetero Spot Light Module and, in addition to their standard series the recently improved Decor Ultra series, now offering up to 5000lm at CRI 97. The aim of the booth was to demonstrate that the right product choice for an application is the key for a successful product. The message seems to be: Use high CRI products where they are really needed and the most efficient product when CRI is of minor importance.

Optogan showed their new Module X10 in several variations and configurations as samples and in applications. The ease of configuring different power ratings from 10 to 500 watts with different current/voltage combinations using the solder free

**Figure 14:** Megaman's new TECOH® MHx module is designed to offer a viable LED alternative to ceramic metal halide lamps



holder is the unique feature of this product, whereas power ratings above 250 W need active cooling. In addition, the powerful Sky 200 high bay lamp street light and the Dynamic Sportfield foodlight, which can be configured to deliver up to 187,000 lumens, were highlighted.

Megaman, who have only been known for their replacement lamp business up until now, entered the module business at Light+Building 2012. For downlights they now provide the Zhaga compliant TECOH® CFX module, while for demanding spotlight applications Megaman sees the TECOH® MHx, which does not comply to Zhaga standards, to be the better solution. Using the TECOH® MHx modules allows a similar design to the Megaman spot lamps.

Verbatim, newcomer in 2010 and now established with its replacement lamps, expanded its product line to provide both highly efficient and primarily high CRI optimized lamps. An example for the new highly efficient lamps is the 7 W MR16 GU5.3 lamp with 450 lumens at 64 lm/W.

Intematix, a phosphor provider of remote phosphor systems, demonstrated its product by displaying end products from several clients. As an example of the company's most advanced light conversion technology, Vexica's recently announced Lumaera OEM LED module was on display. Furthermore the 3-D remote phosphor products ChromaLit Ellipse, Candle and Dome were shown.

Everlight introduced the Shwo D series which is a surface-mount high-power device featuring high brightness combined with a compact size. Another highlighted product was the SOHO Downlight module.

Xicato, located at the front of Hall 4, at the Agora, once more demonstrated their understanding of light quality. They showcased all recently improved and new products from the XLM LED modules to the XSM and XSM Artist series. But what really impressed lighting specialists was an installation of numerous Xicato modules of which some already had 18,000 working hours, lighting up single small windows. The visitor could guess which part was lit up by an old module. Color consistency was surprising. An illuminated wall offered another chance to guess, with one side lit up by a halogen spot, the other by a spot using the Artist series modules. There was almost no chance to guess correctly without cheating!

Osram's LED Light for You booth once more offered 16 partner companies an opportunity to display their products and services. Driver IC and driver manufacturers, like Diodes, Infineon, Supertex, Roal and Recom, as well as optics manufacturers, Carclo, Bicom and LEDil , design, OEM and manufacturing service providers (Lighting Innovation Group, AT&S, RAFI, SoftRay, Asetronics, Mechaless) and measurement specialists, like opsira, gave a good overview of what makes an LED luminaire and LED system.

**Figure 15:** Vexica's recently announced Lumaera OEM LED module is one of the first products using Intematix's most recent remote phosphor technology



**Figure 16:** PhotonStar's latest module allows color tuning at a constant high CRI of over 90

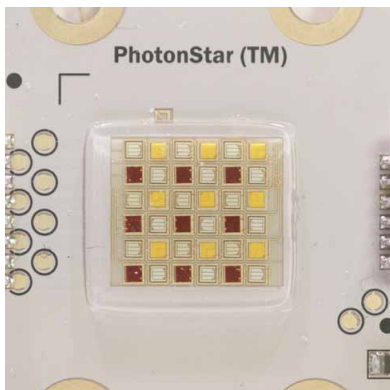

**Figure 17 (left):** Everlight's SOHO downlight module

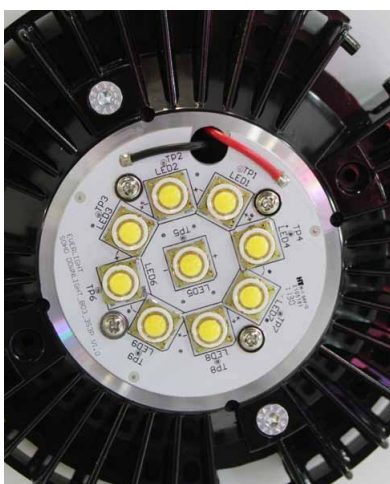

**Figure 18 (right):** Installation of numerous Xicato modules of which some already had 18,000 working hours, lighting up single small windows. Visitors could guess which part was lit up by an old one

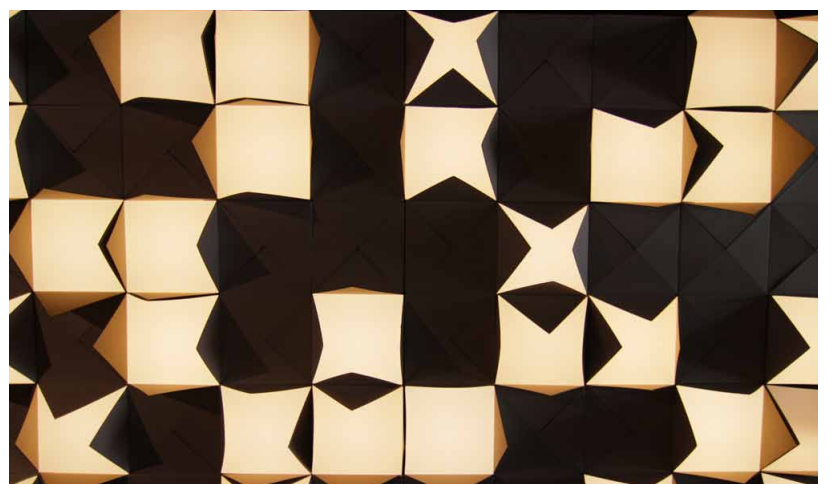

**Figure 19:**  
Khatod's  
outstanding  
robust new  
PL50SIL lens is  
based on silicone  
and perfect for  
the outdoor  
applications



**Figure 20:**  
Alu Luxar's  
reflector for  
Xicato's new XLM  
LED modules

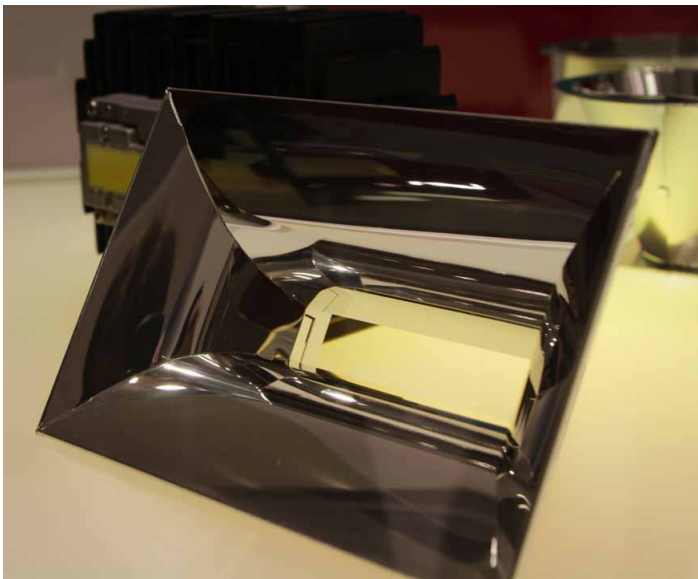

**Figure 21:**  
TALEXX modules  
and converter  
LCAI 2x38 W and  
2x50 W one4all  
outdoor series

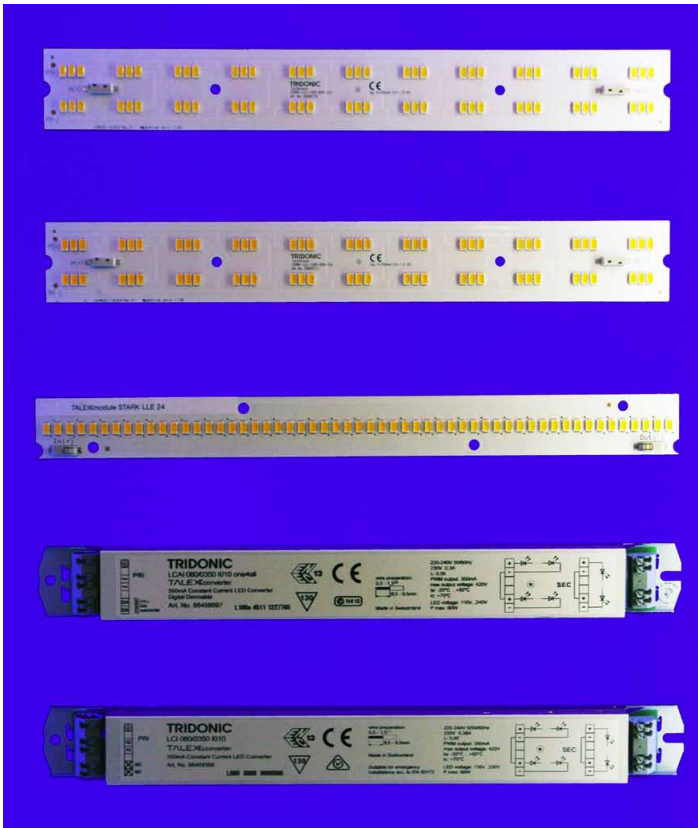

## Optics and Optical Materials

Carclo, Gaggione, Khatod and LEDil presented their latest products. While LEDil featured the STRADA 2x2 lens array street lighting optics and its recently announced non-metalized RITA-A reflectors, Khatod, demonstrated its silicone lens, for the first time, which is resistant to high temperatures and considerably reduces the yellowing effect. In addition, they displayed the Zhaga conform LYRA reflector system. They also showed the Pixel reflector system and samples of most of their well introduced products. Gaggione, primarily known for their high quality custom made LED optics, light-guides, prisms and optics for special applications, showed some samples from their clients and, in addition, the most recent standard products including the specialized lens holder for the Star PCB P5-II solution from Seoul Semiconductor. Carclo presented its broad product portfolio, including their newly introduced reflector systems. Newton, for the TE holder compatible Sharp Mega Zenigata series, Archimedes for high bay applications and the Hive for Osram's Brilliant Mix® System, as well as the new free-form street lighting lens Hubble, which is also suited for down lighting & interior applications.

## Electronics

The majority of driver IC manufacturers showed application examples with their latest products, most of them featuring TRIAC dimming solutions. Just to name a few, Infineon, Diodes and Supertex, were present either with their own booth or as the partner of a distributor. LED converters, supplies and controls were shown from all prestigious lighting electronics suppliers like Barthelm, b.a.g, eldoLED, Fulham, Harvard, Insta, HEP, Mean Well, Nobile, Roal, Recom, Tridonic or Vossloh-Schwabe. Tridonic featured its new emergency lighting product range and the new TALEXXconverter LCAI 2x38 W and 2x50 W one4all outdoor series. Harvard showcased the new DualDim CL50/CLR50 converters, which can be used with both DALI and analog dimming. Recom focused on the recently introduced RCD-48 and RACT20 products. While the RCD-48 is intended for LED strings and multi-chip arrays with power ratings up to 70 W and is designed to provide a MTBF of 1.7 million hours, the RACT20 allows flicker-free TRIAC dimming down to zero for LED loads of up to 20 W. It comes with a 5 year warranty and is designed for a lifetime of more than 70,000 hours. Future Lighting, essentially a distributor and service provider, now provides Rena's Bits2Power driver and controls. It is very interesting because of the simple but flexible system.

**Figure 21:**  
The new compact Nuventix SynJet can handle up to 57 W of module power



**Figure 21:**  
Lustrous presented a Zhaga conform spot module



**Figure 21:**  
Lextar's Bluetooth based smart lighting system has now been officially released

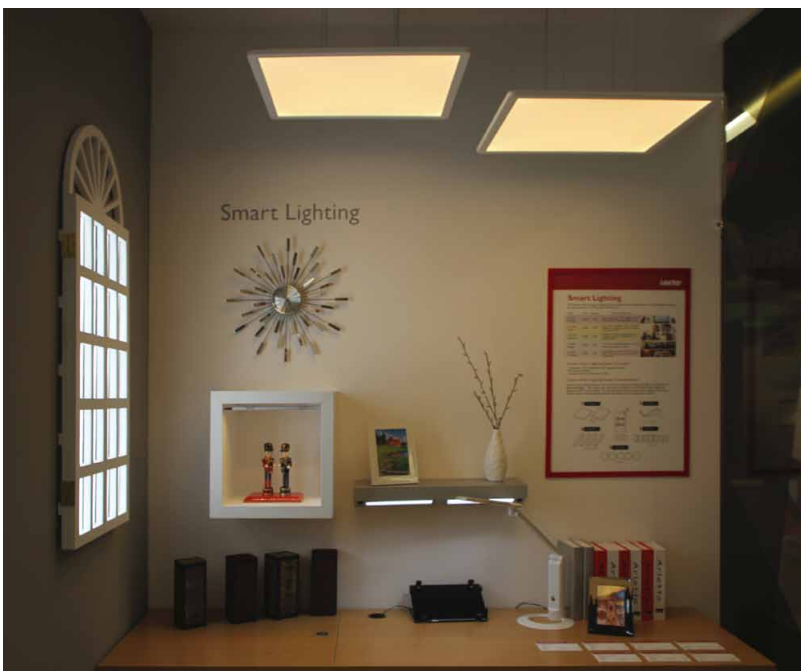

## Thermal Management

Some specialists in thermal management like Advanced Thermal Devices, Bergquist and Heraeus with its thermal management products also attended the fair. Nuventix joined the show once more with new SynJet coolers in a range from 57 W to 77 W cooling capacity. In addition, the prototype of a 150 W SynJet for compacter and lighter high bay solutions was on display.

## What's up in Asia? Hall 10.1

The trend of more high quality products that we noticed in 2010 has clearly continued. Exhibitors like Signcomplex, Guangzhou Hongli Opto, Unilumin Group, Dongguan Kingsun Optoelectronic, Matrix Holding Limited, SunSun Lighting China, Shanghai ET Lighting, Elec-Tech International, Civilight Technology, Quasar Light, Fujian Evlod Opto-Electronic, Shenzhen Crep, Rayconn Electronics, Sichuan Jiuzhou Electric Group, Shanxi Guanyu LED Lighting, Paragon Semiconductor Lighting Technology or LiteOn all presented high class products.

This year the Taiwanese manufacturers and suppliers demonstrated their innovative power. In addition to the broad range of optics LedLink Optics showcased its virtually glare-free Hybrid lens series. ARC Lighting won people over with its sophisticated DMX based LED solutions for dynamic lighting displays. SemiLEDs with its proprietary MvpLED™ technology disclosed the latest advances in LEDs on copper alloy that provide much better heat conduction, thus eliminating the bottleneck effect. Epistar presented their improved, next generation HV-LED system for high CRI white light generation, now delivering 150 lm/W at a CRI of up to 90 for warm white LEDs. In real life applications at least 120-130 lm/W can be achieved. Prolight Opto Technology showed the current Epistar technology in some of their packed products and modules. Lustrous, which is a Zhaga member and whose founder, Dawson Liu, is an official Zhaga spokesperson, also promoted Zhaga compliant products, as well as a very interesting

remote phosphor module and its highly efficient, recently launched N506 COB LED series. Lextar demonstrated very homogeneously lit up panel lights, a new really omnidirectional replacement lamp series and the now released Bluetooth® Smart based LED lighting control system that was on display as a prototype at LED Lighting Taiwan.

### OLEDs – The Next Lighting Experience

Not limited to a specific hall and also shown in very different ways, from the pure technical approach to the application, OLEDs were omnipresent, not in high volumes but from numerous manufacturers and providers, comparable with the demonstration of LEDs at the Light+Building 2006. Ahead of everyone else, Philips with its Lumiblades, Osram with the Orebos and Zumtobel with the Lureon and Luceos modules of its subsidiary Tridonic, showed not only OLED modules but also luminaires and light installations. Sumitomo joined Light+Building for the first time with its polymer OLEDs in sixty different colors. Lextar was also there showing OLEDs. Besides the newcomers in the OLED lighting business, Konika-Minolta also demonstrated its ambitions. The forerunners, Blackbody and Novald exhibited their OLED technology in applications and artworks of extraordinary design. In comparison, Verbatim's OLED wall excited the visitors because of the color tunable OLEDs. While the presented installation used the current versions, at the same time, the next generation of OLEDs, offering twice the efficiency and illuminance, over 60lm/W and 2000cd/m<sup>2</sup>, were introduced to the public.

### Advances, Trends and Rumors

In 2010 the luminaire industry was seeking a solution to reduce the incompatibility of modules from different manufacturers. Zhaga defines the mechanical, electrical and thermal parameters to make light engines exchangeable. Although the standard is seen as controversial, most specialists agree that it was necessary to agree on a standard and that in the end this would be an advantage for consumers and the industry. The huge number of Zhaga compliant products from modules to optics; products awaiting certification or designs with Zhaga compliant products demonstrates a major trend that was easy to see at Light+Building 2012: The Zhaga standard is accepted and compliant products will likely take over the lead in standard products.

A second trend can be seen in the broadened range of OLED suppliers. New players are entering this business and are adopting the technology quickly. Color tunable OLEDs are at this time certainly the most exciting innovation.

Although LEDs can be seen everywhere and are nothing special anymore, new innovations and trends can also be recognized. While 150lm/W LEDs were already announced in 2010, and array LEDs and modules were demonstrated, what is happening in 2012 is a lot more than that. On the one hand, luminaire manufacturers have learned to apply LEDs correctly and on the other hand, LED manufacturers and component suppliers now understand the requirements of luminaire manufacturers much better. They have

even started services to support their clients in the development of their products. What is especially remarkable is the product portfolio adaptation of all the important LED manufacturers. In 2010 it was relatively easy to categorize manufacturers regarding an outstanding performance parameter like highest efficiency, best CRI, highest overall luminous flux, narrow MacAdams binning. In 2012 almost every well-known supplier offers all of that. This leads to better, more reliable and still more affordable products appropriate for the task and application. This is definitely one of the major trends in the LED business. But the next trend is already starting and this one is important for the accelerated adoption of LED lighting. All of the LED manufacturers take measures to reduce costs without sacrificing one of the important technical parameters. For example, Cree introduced the SC<sup>3</sup> technology. Other companies will follow with their own technology, or have already quietly done so.

GaN-on-Si LEDs are around the corner. Almost every week another research lab or company releases news about that technology. The latest rumors say that Bridgelux has solved all the major technical problems and is just finalizing a manufacturing process with its partners for mass production in the first quarter of 2013. If that is true, we'll see GaN-on-Si based luminaires at affordable costs at Light+Building 2014! ■

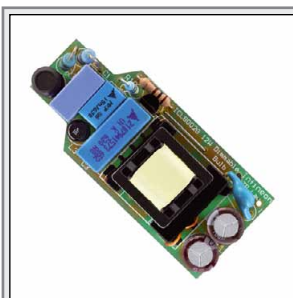

### Infineon Enables Next Generation Dimmable LED Lamps with the New Controller ICL8002G

The ICL8002G supports single-stage flyback or buck solutions with PFC and superior dimming functionality. Primary side control techniques enable next generation line voltage based LED lamps and luminaires with lowest component count for smallest form factors and simplified designs. Solutions powered by ICL8002G achieve noteworthy phase cut dimmer acceptance and continuous dimming over a wide range. The IC incorporates a high-voltage startup cell for instant light-on and multiple safety functions. Various evaluation boards are available for fast time to market.



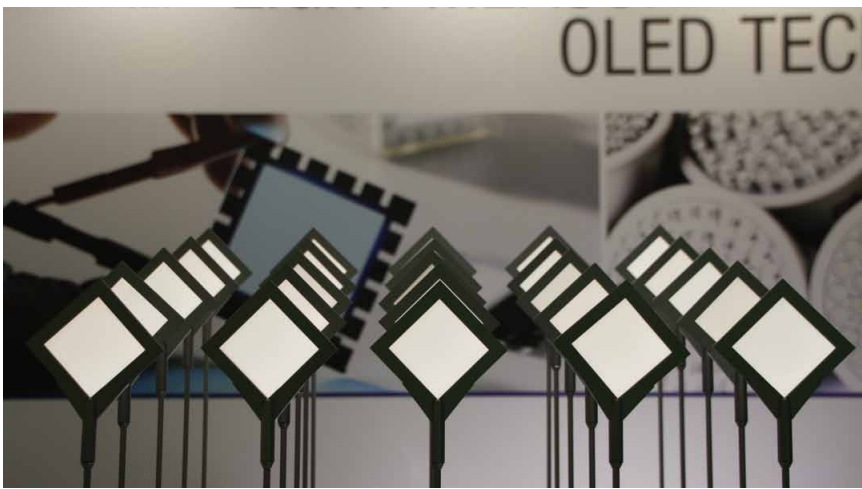
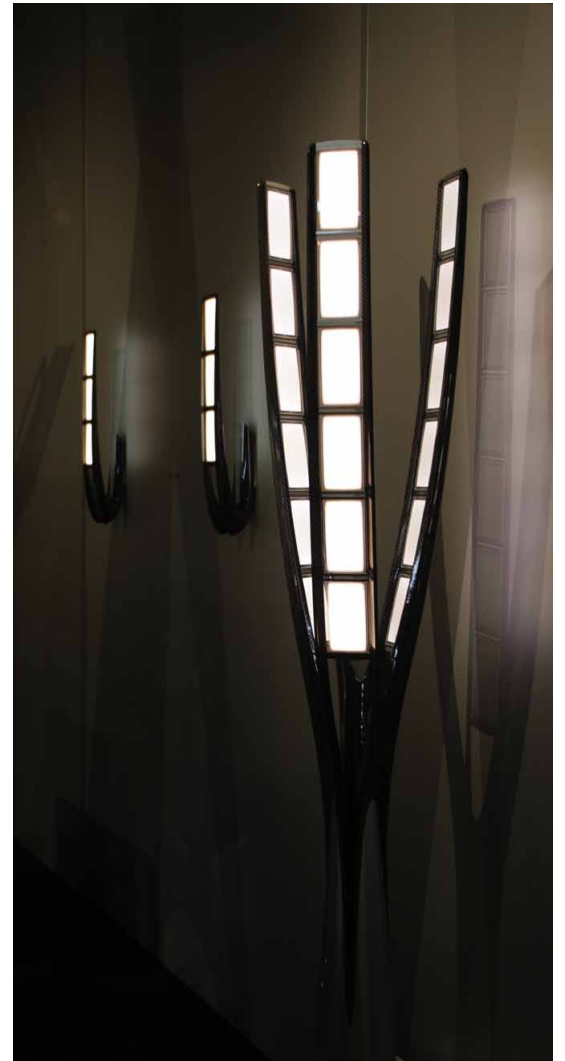
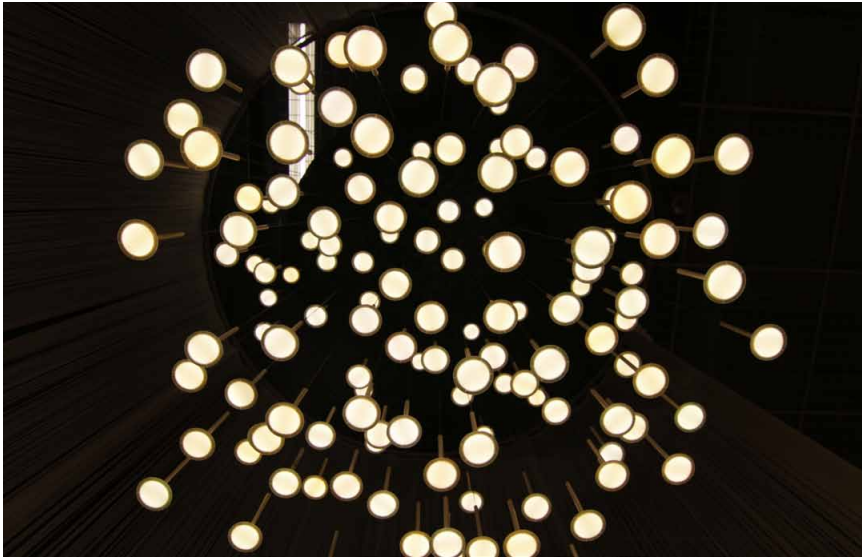

**Figures 22-25:**  
OLEDs from various  
manufacturers were shown at  
Light+Building 2012:  
Blackbody (top left)  
Novaled (top right)  
Konika-Minolta (middle)  
Verbatim (bottom)

# Zhaga - Insights into the New LED Lighting "Standard" for Light Engines

Greg Galluccio, Director of LED Business Development and Product Management for Lighting and Energy Solutions at Leviton and Zhaga spokesperson, talked to Siegfried Luger and Arno Grabher-Meyer from LED professional at the Light+Building in Frankfurt about the Zhaga LED lighting "Standard". The industry initiative, Zhaga, will fundamentally influence the lighting business because of the interchangeability of LED light engines.

**LED professional: What was the reason for establishing Zhaga? What is the history of this industry initiative?**

**Mr. Galluccio:** The name Zhaga was chosen arbitrarily so that it can't be confused with anything else in the industry. The organization came about because the lighting industry as a group simultaneously realized that the lack of interchangeability of LED products was a major problem for the promotion of LED lighting. The lighting industry has been operating in a completely interchangeable way for the past hundred years. For example, if you have an E27 socket, you can take the bulb out of it and replace it with another one. Unfortunately these sockets don't have the heat exchange capability and some of the other electronic delivery capabilities that are needed for LED lighting. Therefore, when it came to commercial products there was no interchangeability. This causes a great deal of concern on the market. The luminary manufacturers are asking themselves if they should really invest in LED lighting because when they use a certain light engine with a specific form factor it's possible that they will have to change the reflector and fixture design six months later.

About ten of the larger companies initiated Zhaga but there were already 30 companies attending the first meeting in February 2010. There are now 192 members and 55 of those have full membership with voting rights. The remaining 137 are associate members. They have access to the data and can attend the meetings.

**LED professional: What is Zhaga's strategy and roadmap for specifying LED light engines?**

**Mr. Galluccio:** The main point that Zhaga is trying to address is the interchangeability in geometric requirements. We do not specify quality of light output, safety, end-of-life or any other things that are covered by other standards like the IEC. Our goal is to make sure that within this interchangeable device there is still the freedom to design any kind of technology. In this way you could have a device that has very low CRI or other performance figures because it might be better and cheaper in the application. On the other hand, you can design the same module with the same form factor that has very high performance values appropriate for the application. So we have created a total of seven specifications which are known as books. These are the specifications for different application modules including

the control gear like a complete spot-light module. One of the books available is for general specifications.

"We don't want to limit the diversity and the potential of the LED medium. We have to be very careful about that. We're only trying to facilitate the commercialization of the product by easing the interchangeability"

Greg Galluccio

**LED professional: Is there also an electrical specification?**

**Mr. Galluccio:** We do specify the dimensions for internal and external drivers but we don't specify, for example, the LED driver currents.

**LED professional: Are these seven books the final specification or are there thoughts on expanding?**

**Mr. Galluccio:** Right now, there is nothing new on the table. The process that we use is that the member companies come to us and propose a different enough application which the consortium will then review. The other thing that is necessary in order to work on a book is that enough companies



are willing to actually participate and create a product according to the new applications.

There is one more book that is being written about dimming characteristics. We are trying to specify dimming curves and the ability of the dimmer-interface within a certain number of parameters with the Zhaga modules.

**LED professional:** Can you tell us more about dimming? You mentioned dimming curves. Are you talking about different curves for different applications?

**Mr. Galluccio:** Yes, there are different dimming curves proposed for different applications and there are ranges within those curves within which the dimmers should operate. We do specify a line with a tolerance as dimming curves. The curves are also specific to the different types of dimming such as 1-10V, DALI or TRIAC dimming.

**LED professional:** It seems that some of the books are related to existing products from well-known manufacturers. Are these manufacturers very influential?

**Mr. Galluccio:** Yes. However, we do have many small companies, especially from Asia, participating. Each company only has one vote. So the process is also very attractive to the smaller companies.

**LED professional:** But the larger companies also reveal knowledge about their modules. How does that work?

**Mr. Galluccio:** Part of the Zhaga agreement, when you join, is that any form factor technology you introduce to the group is free and clear of royalties. As soon as you bring a design into the group there is no protection any more. Access to the standard is limited to the participants at the beginning because they are spending a lot of money and resources to help develop the standard. It is only fair that they should have first access. However, over time, these standards will be available generally.



**Figure 1:** It can be easily recognized that some Zhaga specifications, especially Books 2 & 3, are derived from modules which were designed and introduced by well known suppliers a while ago

**LED professional:** What is the market feedback about Zhaga? Have you seen any results yet?

**Mr. Galluccio:** The market is only just seeing this now but I think the reaction will be very positive for a number of reasons: First, the luminary manufacturers can now design their products based on certain dimensions. Second, people can plan and roll-out lighting schemes based on Zhaga modules knowing that they will get corresponding parts in years to come.

**LED professional:** How do you get a certified Zhaga module?

**Mr. Galluccio:** Certification is one of the topics Zhaga is working on right now. The Zhaga logo on a product signifies that it has been tested and certified by a third party in a

certification organization. We created a process by which lighting laboratories can apply for and become recognized laboratories. Unfortunately, right now there are only three: UL, DECRA and VDE. In the meantime, we're trying to expand this certification network.

**LED professional:** As far as we have heard, these laboratories don't have the resources to cover all the enquiries. Is this true?

**Mr. Galluccio:** What has happened here is that there is a bottleneck. We only just finished our accreditation of these laboratories 3 months ago and as soon as they were authorized to do the testing, everybody submitted their Zhaga modules. Once the bottleneck clears, though, we'll see more and more products getting certified.



## Greg Galluccio

Greg Galluccio is Director of LED product development and lampholder product management for the Leviton Manufacturing Company. His experience spans 32 years in the electrical products industry with expertise in product safety and standardization, engineering management, new product development, marketing and business development. Mr. Galluccio is currently serving as Leviton Manufacturing Company's lead liaison to the Zhaga Consortium.



**Figure 2: The shown module from b,a,g, electronics is one of the first samples for the latest Zhaga specification, officially announced on April 6<sup>th</sup>, 2012. Book 7**

**LED professional: What will be tested during the certification process?**

**Mr. Galluccio:** There are gauges to check what fits and doesn't fit the product. The form factor and the screw placement will be checked but the arrays of the LEDs and the type of light output given will not be tested. The spacing of actual LED chips must be tight enough so that you don't end up with rings and patterns on the reflector, and we do test for that. So, the actual density that must be met is tested for but not color temperature or CRI or output power – or anything like that.

**LED professional: What about thermal resistance. Will that be tested as well?**

**Mr. Galluccio:** Thermal resistance is actually tested and noted. What we have is a module where you should be able to read what the thermal characteristic of the module is and you can match the module to a specific

heat-sink by seeing these two specification numbers. So in general, the overall test covers some mechanics, some optics and some thermal characteristics. Security testing according to IEC has to be made with or without Zhaga – These tests are mandatory for all products in general.

**LED professional: Will the Zhaga specification be applied as an international standard?**

**Mr. Galluccio:** When the industry group got together and said that we have to do this and we have to do it very quickly - the first thought was "why don't we go to the IEC?" However, the process through IEC takes very long and in order to get seven books accomplished through them it would probably have taken a decade. The Zhaga consortium has been meeting 6-8 times a year and each meeting is hosted by a different member. Once these books are finished and tested and are in maintenance mode I think we will try to get the IEC to take them over and maintain them as a standard.

**LED professional: Will we see new connectors for retrofit lamps?**

**Mr. Galluccio:** Eventually Zhaga will migrate into the residential/retail market. Right now the market is not very sophisticated and people are not looking for alternatives to the retrofit lamps. We believe that it will happen sometime in the future, though.

**LED professional: Thank you very much for this interview.**

**Mr. Galluccio:** Thank you. ■



## Dimmable M-SPOT Series LED Spotlight

### Features:

- Can directly replace conventional spotlight
- Super Energy-saving, 6.5W = 50/60W Incandescent lamp
- Low heat, No UV & IR
- Long lifespan: over 40000 hours
- CE / GS / Rohs compliant
- GU10 / E26 / E27 / GU5.3 base are available

For further information please contact SignComplex at

[www.signcomplex.com](http://www.signcomplex.com)



[www.signcomplex.com](http://www.signcomplex.com)

# High Efficiency High Voltage High CRI



## Welcome!

2012 LIGHTFAIR INTERNATIONAL, USA  
Date: May 09, 2012 - May 11, 2012  
Booth : 5711

2012 guangzhou international  
lighting exhibition, China  
Date: Jun. 9, 2012 - Jun. 12, 2012  
Booth : Hall 4.1 No.A02

2012 LED Lighting Taiwan  
Date: Jun. 19, 2012 - Jun. 21, 2012  
Booth : M806



### EdiPower® II HR 9W/ 13W/ 24W/ 35W

- Cool White 36V 2600lm 85CRI
- Neutral White 35V 2600lm 85CRI
- Warm White 34V 2600lm 85CRI

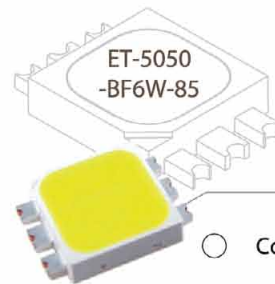

### PLCC 5050 HR 1W

- Cool White 18.3V 115lm 85CRI
- Neutral White 18.3V 115lm 85CRI
- Warm White 17.5V 120lm 85CRI

1. LED is a dynamic, creative and evolving technology. Please refer to the datasheets for final specifications. 2. Other colors is available upon request.



4F, No.800, Chung-Cheng Rd., Chung-Ho Dist., New Taipei City, Taiwan 23586  
T+ 886 2 82276996 F+ 886 2 82276997 service@edison-opto.com.tw www.edison-opto.com



www.edison-opto.com

# LED Module Selection Considerations – The Datasheet and Beyond

The module market has grown dramatically over the past few years. In order to be able to make the right choice, an evaluation of all the modules considered is vital. John Yriberri, Director of Global Application Engineering at Xicato, Inc. discusses considerations for module selection in order to guide luminaire manufacturers through the decision making process.

In the middle of the last decade, high brightness LEDs were beginning to get powerful enough to be considered for general lighting and by 2007, luminaires entered the market that could start functionally replacing low wattage incumbent lamp types. Around this time, a few companies started to introduce this new concept of an “LED Module” which housed LEDs in a form factor that was predictable and that could easily be integrated by luminaire manufacturers. The number of companies offering module solutions has grown, especially in the last 18 to 24 months where there has been an inrush of modules to hit the market. Everyone from the large existing players who dominated traditional lamp manufacturing to startups out of Silicon Valley now have a module solution. The module market, has literally, exploded.

For a successful luminaire design it is substantial that manufacturers conduct a complete evaluation in order to get the performance, flexibility and longevity they expect in a future-proof module platform. The tricky part in all of this is that some of these items that will be discussed are apparent and obvious

on a datasheet whereas other items are less apparent, hidden or often not considered. For this reason, this article is divided into “Typical Considerations” and “Non-Typical Considerations” that come up most frequently in discussions with luminaire manufacturers.

## Typical Considerations

Aside from early adopters who often jump on a new “cool” technology as soon as it is released, the “early” and “late majority”[1] of the market are first looking for stability of a product in the market. For this particular market, stability is defined in terms of form factor and product offering. The feedback from the market is that a stable module platform should be around for at least 2 to 3 years without changing form factor or mechanical interfaces. Changes to form factor and mechanical interface impact luminaire manufacturers. These changes often require re-tooling and additional engineering and ultimately cause supply chain inefficiencies and added cost. Those that have been burned on this in the past know the negative impact this can have and the frustrations associated with change. In terms of product offering, luminaire manufacturers benefit the most when a single platform supports a wide range of applications. Different

applications often require different flux (lumen) packages, various color temperatures from cool white to warm white, both standard (80+) CRI (color rendering index) as well as high CRI (95+) products, and the option of tight part-to-part color consistency.

For flux packages, luminaire manufacturers should focus on modules that have output values that are not just the average (or best) of what is currently being produced within the factory, but are intentionally planned and align with existing technologies. A good example of module manufacturers not thinking this through is when a datasheet reports a product to be “713 lm”. Clearly 713 lm is not strategically selected, but rather the average, typical or maximum value of what is being produced. One can’t help but wonder what the output will be 3 months from now, as efficacy increases, will the new datasheet read “713 lm” or will it move to a new average? Constantly changing the lumen values is a nightmare for luminaire manufacturers because it makes it difficult to keep marketing material and LM-79 testing current and accurate, but also may cause problems in the field when replaceability is considered - will it look the same? The future-proof approach is to target packages with lumen

**Figure 1:**  
Visual comparison  
of 80 CRI vs. 95  
CRI

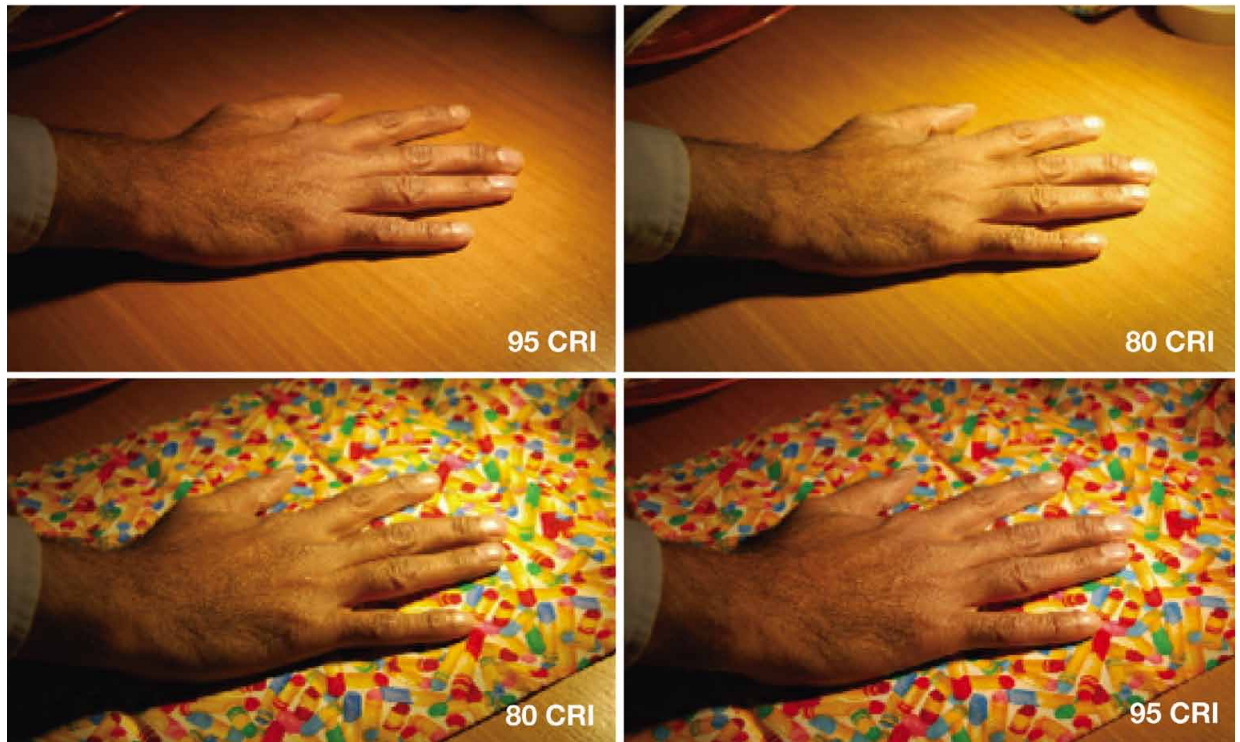

specifications at application temperature (say 70°C) and that align with existing lamps (e.g. 700 lm for 35 W Halogen IR MR-16, 1000 lm for 50 W version). Although this seems simple, it is often overlooked. The burden should be on the module manufacturer to deal with the difficulty in making sure they ship products that meet specification.

Selection of correlated color temperature (CCT) is usually application and regionally dependent as some cultures prefer cooler or warmer CCTs than others. Modules should be offered in several CCT options: 2700 K (warm incandescent), 3000 K (halogen), 3500 K (fluorescent used extensively in North America) and 4000 K (neutral white). CCTs above 4000 K / 4100 K are used less frequently, especially for general lighting applications.

Color rendering (CRI) is also application dependent, so within the same platform and at all CCTs, CRI options of 80+ and 95+ should be offered. For general ambient lighting, or less critical accent lighting, most find that 80 CRI is sufficient to fit the design. More demanding installations, such as art galleries, high-value displays in department stores, and dining areas of nicer restaurants should have the option of designs that

provide incandescent like rendering capability. To get true incandescent equivalent color rendering, a minimum CRI value of 95 (average of indices R1-R8) as well as values greater than 85 for the saturated colors (indices R9-R15), are required. Products with 90 CRI have improved rendering capabilities over 80 CRI, but it is still a compromise when compared to halogen or incandescent. Figure 1 shows a visual comparison of 80 CRI vs. 95 CRI. Offering only one CRI package limits design opportunities and usually limits the luminaire manufacturer's portfolio or requires them to pursue a different solution which adds to the design time, creates inconsistency in the product line, and adds cost.

Part-to-part color consistency is also application dependent but required for certain installations. A 4-step MacAdam ellipse (4 SDCM) may be suitable for some general lighting applications but some instances require a tighter part-to-part consistency. A study conducted by Rensselaer Polytechnic Institute's Lighting Research Center (LRC) concluded that a "2-step MacAdam ellipse [is required] for applications where the white LEDs (or white LED fixtures) are placed side-by-side and are directly visible, or when these

fixtures are used to illuminate an achromatic (white) scene. Accent lighting a white wall and lighting a white cove are some examples." In 2008, an internal study that focused on determining the bounds for color consistency was conducted at Xicato. In this case lighting designers helped determine what was acceptable and what was not. What we found was that even a 2-step MacAdam ellipse had too much variation for some instances. We found that the human eye is more sensitive to variation when moving off the black body locus ( $\Delta uv$ ) than along it (CCT). Figure 2 shows the CIE 1931 diagram and the black body locus along with common CCTs. Change following along the curve represent change in CCT, while change in  $\Delta uv$  is represented as the lines that cross the

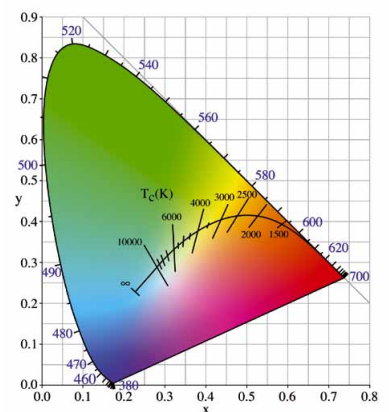

**Figure 2:** CIE 1931 diagram

**Figure 3:**  
1 x 2-step  
MacAdam ellipse  
specification for  
different CCTs  
as well as other  
comparisons

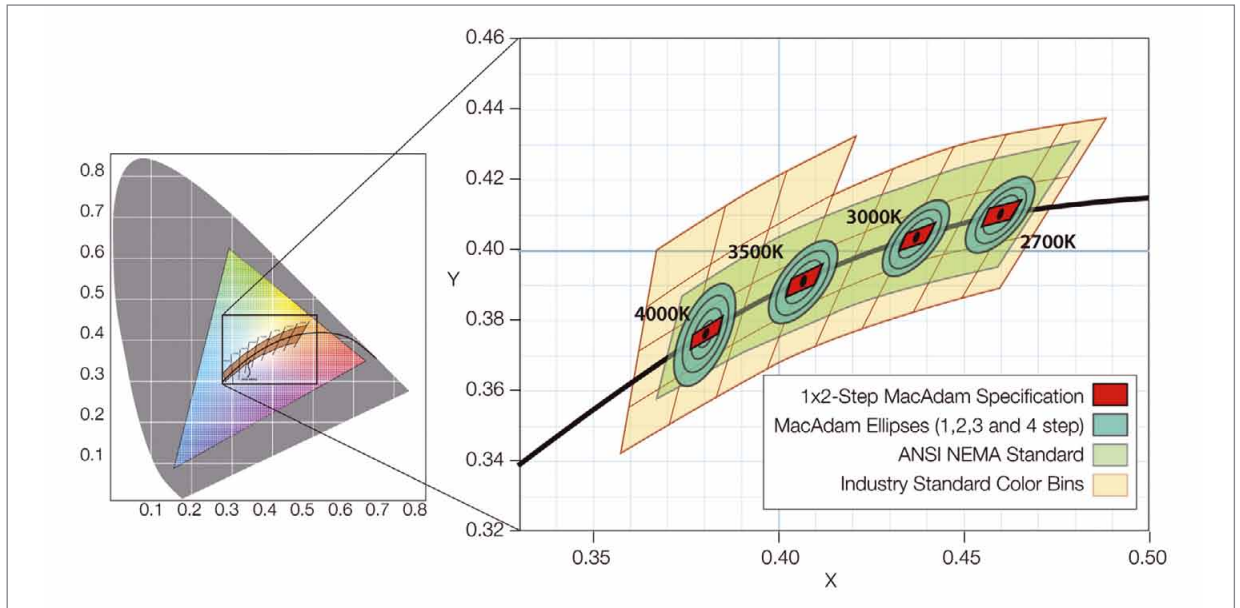

curve. A negative value for  $\Delta uv$  falls below the black body locus, while a positive value falls above. The specification that ensued was a 1-step MacAdam ellipse off the black body locus, and 2-step in the direction of CCT. Figure 3 shows the 1 x 2-step MacAdam ellipse specification for different CCTs as well as other comparisons. Because lighting fixture manufacturers don't always know where their product will be used in application, a 2 step MacAdam ellipse product should be default over a 3 or 4-step MacAdam ellipse product to ensure the application is always lit appropriately. Selecting a module for integration that has less than 2-step MacAdam ellipse consistency will ensure that the lighting fixture can be used universally without concern. It is important to note that there should be no penalty (price, performance, etc.)

for selecting a tighter consistency than required. An example of perfect color consistency is shown in Figure 4.

Before moving on to non-typical considerations, I'd like to briefly touch on module efficacy. Environmental impact (reducing energy consumption) is linked to a technology's uptake, so for LED lighting to make a global impact on energy consumption, it must begin to universally replace existing technologies like halogen and incandescent. One of the challenges in LED for lighting is the link between light quality and efficacy: the higher the light quality, the lower the efficacy. Trading light quality to maximize efficacy can result in a lower uptake and thus a lower environmental impact. A good example of this is the CFL bulb. Many people haven't made the switch from incandescent to CFL because there

are too many shortcomings, with poor light quality being one of the biggest. By now, most LED module manufacturers have products with efficacies greater than 55 lm/W, with some being over 70 lm/W. Although module efficacy is obviously important, as long as the products support an efficacy that enables meeting energy codes (e.g. Part L, Title 24, etc.), the advantage of an extra 10-20 lm/W is less important, especially when efficacy is at the cost of light quality.

### Non-Typical Considerations

Now comes the fun part of the discussion. Many of lighting specialists are well versed in the above topics, or have at least read an article or heard a talk from one of my peers in the industry. As mentioned above, the next section addresses considerations that are less obvious, hidden or not openly discussed.

**Figure 4;**  
Example of  
perfect color  
consistency



### Optical Aperture (source size)

At first glance, optical aperture or source size may not seem that important, but a thorough investigation will reveal it is more important than one might think. First, the size of the aperture (often the diameter) is critical for photometric considerations. Smaller diameters where the light is being generated allow for smaller optics to control or shape the light. In accent lighting, narrow beams are sometimes required and the size of the

International Expo & Conference gathering 500\* exhibitors from around the world

Held inside **LIGHTING JAPAN 2013**

# 5th LED/OLED Lighting Technology Expo

**Light-Tech**



*Lighting Devices*

*Components*

*Equipment*

*Materials*

**Exhibit here and conduct business with 32,000\* quality visitors.**

(\*expected, figure of LIGHTING JAPAN)



*For exhibiting information >>> [www.lightingjapan.jp/en/](http://www.lightingjapan.jp/en/)*

**Concurrent Shows inside LIGHTING JAPAN**

3rd **LED/OLED Light Expo**  
Light-Expo

**DESIGN LIGHTING TOKYO 2013**  
1st TOKYO DESIGN LIGHTING EXPO & CONFERENCE

**January 16 [Wed] – 18 [Fri], 2013**  
**Tokyo Big Sight, Japan**

Organised by: **Reed Exhibitions Japan Ltd.**

Organised by  
 **Reed Exhibitions**

optic can get big depending on how tight of a beam is needed. For example, a 22 mm diameter optical aperture requires roughly a 90 mm diameter optic to achieve a 15 degree full-width-half-maximum (FWHM) beam. The size of the required optic scales with the size of the aperture, so if the source diameter was instead 70mm, the diameter of the optic to achieve the same 15° beam would be over 400 mm. In general, the smaller the source size, the smaller the optic required to achieve a narrow beam. It is important to note that high lumen packages within small optical sizes are very difficult to create without impacting quality of light metrics and reliability, so there's real value in a module that can deliver this. The bottom line is that if smaller optics and tighter beams are of interest, consider a smaller source size.

### Specification consistency

Consistency both in terms of source size and photometric distribution is the next not-so-obvious element to consider, but can be costly if overlooked. In some cases, each lumen package in a manufacturer's range can have a different source size. This potentially means unique optics for each lumen package! Imagine a different 15°, 25°, 36° and 50° optic for each lumen package-that all could be used in the same luminaire! This can be a show stopper for a luminaire manufacturer, not only in terms of design resources but in terms of inventory and sourcing. Look for a module range that has a consistent optical aperture or source size across a wide range of lumen packages (low flux to 3000 lm+). Also check that the photometric distribution is the same for each and that there is a forward looking plan to maintain photometric distribution even if the number of LEDs used is changed to boost efficacy or lower cost in the future. The future proof approach is to ensure that the source size and the photometric distribution is fixed and consistent across all lumen packages. This will ensure that the reflectors or optics used will perform exactly the same across lumen packages, now and in the future.

### Thermal power and Test Point Temperature (Tc)

Thermal power (load) and test point temperature (Tc) are two independent characteristics that come together during integration to determine the amount of heatsinking or cooling that is required. In general, the higher Tc limit (while staying within recommendations for lumen maintenance and warranty) above worst case ambient temperature (Ta), the more flexibility the luminaire manufacturer will have in designing or selecting a cooling solution. Given that the worst case ambient temperature is usually 40°C or higher, a module with a low Tc rating of 65°C for example, doesn't have much headroom above the already hot ambient temperature. Trying to keep a module at 65°C in a 40°C ambient, while dissipating 40 W thermal power is very difficult to do with a passive heatsink, and often requires the use of a fan or other active heatsink. On the other hand, a module with a Tc rating of 90°C or higher (while still meeting lumen maintenance and warranty specifications) has at least 50°C head room over the ambient temperature and should be able to make use of a reasonably sized passive heatsink. It really boils down to flexibility and cost. If a module is chosen with a high Tc rating, there will be more options for design and cost savings than a module with a low Tc rating, assuming the same power dissipation.

Thermal power has always been a difficult number to deal with. Luminaire manufacturers have a hard time differentiating between electrical power and thermal power. Furthermore, LED module manufacturers don't always provide details for how to calculate thermal power because this value can change depending on lumen package, CRI, CCT, etc. Cooling solutions are often rated for performance in terms of "°C/W", which requires knowledge of thermal power. About a year ago, one of our customers suggested we move to a "class system" where instead of a number for thermal power, each module variation is rated to a "thermal class". We liked this idea and adopted it, and hope that others follow suit. The benefit is that the datasheet lists the

appropriate class (A, B, C, etc.) for each module, and cooling solutions are rated similarly. For example, a 1300 lm module might have a thermal class rating of "G", and looking at a heatsink options matrix, a 70 mm diameter heatsink that is 70 mm tall can cool a class "G" (in a 40°C ambient temperature). Instantly, it is recognized that these two are compatible. Note that validation testing is still required for each luminaire during the design phase, as variations in trims, optics, and mechanical structures can change performance. Continuing on with the example above, if the manufacturer designs the luminaire around this class "G" heatsink, then 9 months later a new higher flux module is released to a class "G", there is an opportunity for the same luminaire to now support 2000 lm instead of just 1300 lm. This can be achieved without any additional thermal testing (once the original luminaire design has been validated). Although not critical, it supports good design practice and it is a nice future proof approach to thermal design and integration.

### Electrical, Drivers and Control

This is a challenging subject, for an entire article can be written just around this subject, but there are also some highlights to focus on. Some modules are sold as a "system" (module + driver), while others are more of an open architecture than support many different drivers. There are advantages to each; system warranty being the main selling point for the system approach, and flexibility (design/application/compatibility) for the open architecture approach. For the open architecture approach, close attention to module drive current and voltage range is critical because odd voltages or currents can dramatically cut down on the number of compatible drivers. Most common drive currents are 350mA, 700mA, 1050mA (1000mA), and 1400mA. Drive current requirements other than those listed may pose a challenge to find a suitable driver. Look for modules with drive requirements listed above and drivers that have a wide voltage range, as they tend to be more future proof than narrow voltage range drivers.



**Figure 5:**  
Lumen and color maintenance data

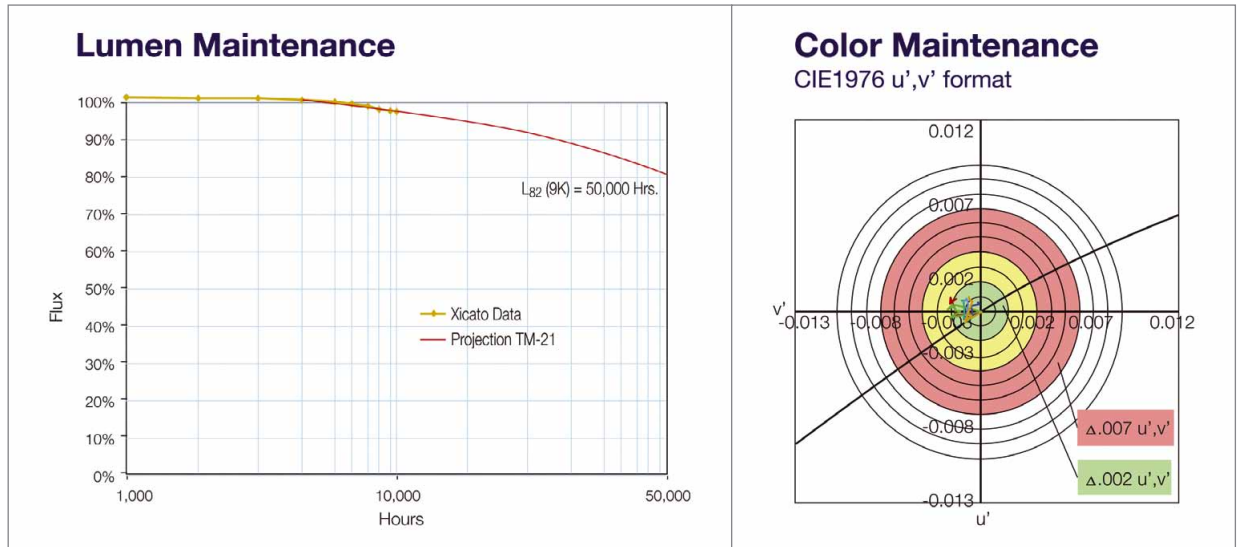

A few disadvantages to consider with the “system” approach, is limited compatibility with control systems (e.g. leading edge [Triac], trailing edge, DALI, 0-10V, DMX, push, etc.). Some systems may only support one or two different control types and may be limited, even within a certain dimming type. For example, a system may state compatibility with “leading edge” dimmers but after testing or field installations find out that it’s only compatible with a very select group of leading edge dimmers. With the open architecture approach, there are so many different drivers out on the market that most control types and applications are covered. Look for a module manufacturer to provide a compatibility matrix for driver solutions that can be sorted by different criteria (dimming type, input voltage, size, etc). Drivers that are part of a “system” usually only come in one size, so if a skinny longer driver is needed vs. a short wide driver, there isn’t much of an option. The last disadvantage that comes to mind is that the “system” approach is usually one module to one driver. So, what happens if a multiple head fixture is required? Usually, 4 drivers would be needed as well. In many retail applications one will find multi-head recessed luminaires, and requiring 4 drivers can increase the cost of the fixture as well as the space required to house the drivers. With the open architecture approach there are a number of multi-channel drivers that can be used to drive multiple light points. Many customers gravitate toward these solutions because of the

flexibility they provide. If warranty is a concern, it is now very common for module and driver manufacturers to each offer independent warranties that are equivalent to the system approach.

### Robustness, Reliability and Warranty

Although robustness, reliability and warranty are separate animals, I’ve lumped them in the same section for this discussion. Let’s tackle robustness first.

Robustness can mean different things to different people, but the list that usually comes up in discussion is handling, Electrostatic Discharge (ESD) and soldering requirements, cleanability, ingress protection (IP rating) and mounting/thermal interface. With the exception of a few, most luminaire manufacturers don’t have clean room type facilities. Nor do they have ESD benches or soldering stations. Sensitive parts and/or plastic housings that require special considerations for handling may require new manufacturing equipment and processes in order to avoid damaging the parts or causing low yields. Cleanability, on the other hand, may not be as much of a manufacturing issue as it is a field issue but it requires consideration by the luminaire manufacturer. End users often ask “can this be cleaned?” or “what happens if I clean this luminaire like I clean the fluorescent fixtures?” If the module can’t be cleaned, is the maintenance crew going to remember

that the new LED fixture can’t be cleaned because of exposed LEDs or phosphors? Similarly, does the module have an IP rating (i.e. IP66) to protect it from dust or moisture. If not, what must be done to make it IP rated? Obviously, starting with an IP rated product certainly makes integration into a dusty or humid environment easier. Lastly, in terms of mounting and thermal interface, how is the module attached and does it get shipped pre-assembled with a thermal interface material? Although some modules have a tool-less interface, most modules now are secured to a mounting surface with screws. So the real question is: 2 screws or 3? Two screws may be sufficient, but the idea of warping and, as a result, loss of thermal interface, always sits in the back of my mind. My background in mechanical engineering dictates a strong preference for the 3 screw approach (error on the side of robustness). This ensures adequate contact pressure as well as avoiding any kind of warping. For thermal interface, look for modules with a pre-applied high performance thermal interface pad. Thermal grease is messy, degrades over time and creates room for inconsistency as a result of applying too much or too little which can have an impact on operating temperature.

In terms of reliability, the proof is in the data. If there is no test in accordance with IESNA LM-80, it is important to ask around or do some research. Essentially, LM-80 is a test procedure

**Figure 6:**  
Output of a typical  
CFD analysis

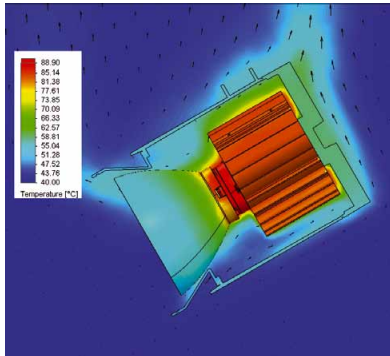

for measuring LED light source performance at application temperatures over time. If a module manufacturer tests in accordance with LM-80, they have the ability to report results. Results that would be most critical are lumen and color maintenance, both, not just one. Figure 5 shows example lumen maintenance and color maintenance data. Lumen maintenance claims should align with the EPA Energy Star's requirements found in "ENERGY STAR® Program Requirements for Integral LED Lamps" document which requires a minimum of 6,000 hours of testing. To make a claim of 50,000 hours the minimum lumen maintenance after 6,000 hours of test is 95.8%, but the test must be carried out to 12,500 hours with a minimum maintenance of 91.8% . Color maintenance is equally important especially for accent applications. If less than 2-step MacAdam ellipse color consistency is required initially, it shouldn't shift to 7-step MacAdam ellipse after 6,000 hours of testing. Results are reported in  $\Delta u'v'$  and, although not exact, 0.001  $\Delta u'v'$  is roughly equivalent to a 1-step MacAdam ellipse. If 0.005 is reported, one knows that the part has shifted roughly 5-step Macadam ellipse from initial color point. This can ruin a beautiful installation after only a short while, so make sure the shift coincides with the application. Bottom line is to ask for the LM-80 test report data and study it carefully.

I won't go too deeply into warranty, but read the fine print. What is exactly being warranted? Ask for the warranty document up front and find out if the warranty is performance-based, supporting both lumen and color maintenance claims, or if it just covers

defects and workmanship. If the warranty is performance based, ask if all the modules are serialized and initial data is stored for each individual module. This is important because traceability would be required to determine how much performance has changed over time.

### Accessory Products

Almost as important as having a good range of modules is having a broad network of partners or suppliers that offer products like reflectors, optics, drivers and heat sinks that have been pretested and screened and support plug and play integration while enabling speed to market and differentiation. Ideally, this would be a wide range of products (good, better, best) for a variety of applications (decorative to outdoor) in an easy to sort format to simplify comparison or selection. These solutions may not be for everyone but certainly for a majority of the market this is a great way to find and select optimized solutions. Module manufacturers should make this all available to their customers via websites and downloads along with supporting data like contact details, CAD models and photometric files.

### Design-in Support

Some module manufacturers offer direct, one-on-one design support. To best suit luminaire manufacturers' needs, design-in should enable speed to market, differentiation, and robustness. There are three areas add value to customers. First, and sometimes taken for granted, is having an Application Engineer from the module manufacturer readily available to respond immediately to questions or requests from customers. Responding can be in the form of an email, a phone call or a direct visit. Many issues can be resolved the same day of contact. Look for a cohesive Application Support team that is eager and willing to help with design-in questions.

The second area that adds value is a module manufacturer that has the ability to perform thermal simulations for customers using Computational Fluid Dynamics (CFD) solvers on a

computer or workstation. Many luminaire manufacturers don't have CFD programs . Nor do they have the personnel to run them. The power of a software-based CFD tool is the ability to determine if thermal objectives are being met by keeping the module below its maximum Tc rating without having to prototype. Multiple iterations can be run in a matter of hours to refine a design without ever having to build a prototype. This speeds up the design process by weeks, if not months, and almost always results in an optimized design that meets design criteria. Not all module manufacturers offer this service, but some do, but some may charge for this service.

The third value added area of design-in support is luminaire validation. Lighting designers and end users want to know that integration has been performed properly and that luminaire manufacturers have worked closely with module manufacturers to integrate a solution that meets life and performance specifications. "Validating" a luminaire is in essence testing the luminaire under worst case conditions, generating a report and validating that it meets design (mainly thermal) requirements. This is a rather new program for most module manufacturers like Xicato. This builds confidence in the market and is great for the lighting industry. ■

### References:

- [1] Moore, Geoffrey. Crossing the chasm: marketing and selling high-tech products to mainstream customers. New York: Harper Collins Publishers Inc.  
LRC Article: <http://www.lrc.rpi.edu/programs/solidstate/assist/pdf/ColorDiscriminationStudy.pdf>  
Energy Star Document: [http://www.energystar.gov/ia/partners/product\\_specs/program\\_reqs/Integral\\_LED\\_Lamps\\_Program\\_Requirements.pdf](http://www.energystar.gov/ia/partners/product_specs/program_reqs/Integral_LED_Lamps_Program_Requirements.pdf)

# Bodo's Power Systems®

Your best choice to communicate!

Free subscription on [www.bodospower.com](http://www.bodospower.com)

One World  
One Magazine  
On Time, Always



Partner with these events:



# Driverless LED Light Engines

Bob Kottritsch, Vice President, and Mike Miskin, CEO of Lynk Labs Inc. ask the question of why a simple light bulb had to become so complicated, especially since LED based lighting is about to dominate the lighting market. They will discuss the “driver free” approach to LED lighting.

When Edison first invented the electric light bulb, he had a delightfully simple concept; to “burn” electricity just like the gas lamp before it had burnt hydrocarbons - to produce heat and almost incidentally light.

Mankind has come a long way in converting electricity to light since then. The latest innovation, the LED, owes its genesis to the high tech semiconductor industry. Perhaps that is a misfortune, since it has inevitably led the industry along a very electronics rich path to high efficiency lighting. As the market for LED based lighting is about to dominate the lighting industry, perhaps this is a good time to question why a simple light bulb should have become so complicated.

An LED looks very much like a simple resistive solid state filament – with a voltage offset. Why then is it so difficult to make a simple LED bulb without the complex and high tech drive schemes which prevail today?

This article will look at the alternative “driver free” approach to LED lighting and examine some of the advantages and a few of the challenges to dispensing with electronics in the humble light bulb.

## Lighting Infrastructure

LEDs are seen as one of the most promising energy saving light sources of the 21st Century. Like predecessor technologies such as CFL, the LED light source is interfaced to the power infrastructure by a driver or ballast. LED Drivers condition the AC power infrastructure to provide an appropriate (DC) (low voltage) regulated power source for the LED light engine.

The problem with Drivers is that they reduce the reliability of and add cost and complexity to what is essentially a very simple and elegant solid state light source. If only the power infrastructure for lighting was low voltage DC ...

That, in fact, is not a good answer. Even in a low voltage DC environment, LEDs need to be conditioned – and with a wide range of forward voltage, current and control requirements, not to mention the inefficiency of low voltage DC transmission of power, the DC lighting infrastructure is a dream unlikely to find a significant place in the real world.

So, AC line voltage infrastructure is here to stay in lighting for a long time. Not only that, the internal wiring of houses and commercial buildings, the switches, dimmers and sockets are also a substantial (looked at globally – an enormous) infrastructure investment in themselves. The inertia of this massive infrastructure means just about all domestic LED lighting has to operate from line voltage, through the installed base of phase cut dimmers into the wide variety of standard lighting sockets around the world. In commercial applications, the scene is similar but the potential for replacement of the fitting rather than of the lamp is more realistic.

If LEDs are going to replace the roughly 20 billion electric lights in the world today, their cost has to fall substantially and the Driver represents a very significant part of that cost. Driverless AC LED light engines connecting directly to the AC power infrastructure could provide a path to reduced cost dimmable LED lighting, accelerating adoption and bringing the LED lamp much closer to the extremely simple ideal represented by the incandescent lamp.

**Figure 1:**  
Typical electronics that is used to drive DC LEDs, in this case from an MR16 lamp

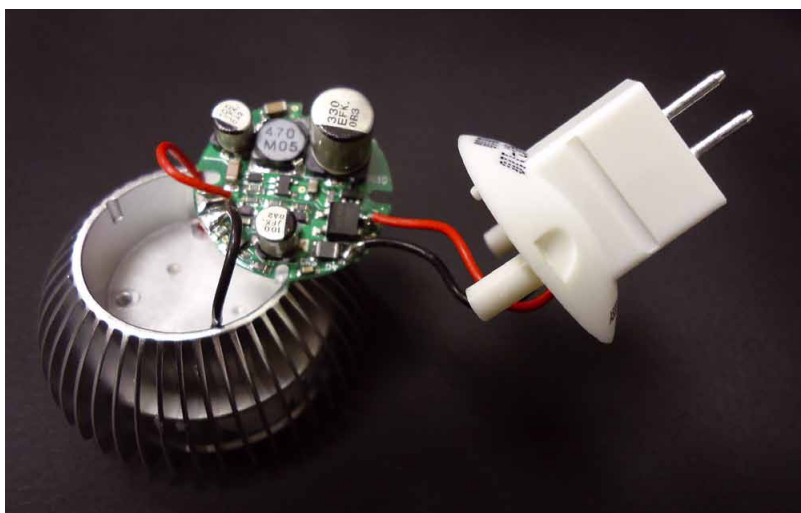

## AC LED – the Driverless LED Light Engine

The first thing to understand about AC LEDs – is that they don't exist. The laws of physics still apply and diodes only conduct in one direction (DC). However, AC LED technology is a real option for many lighting applications. So what is an AC LED light engine – how does it work?

To be able to connect a system of LEDs across an AC line voltage, several conditions have to be met: the total forward voltage of the LEDs has to be comparable to the line voltage; the AC has to be rectified so that individual LEDs are not subjected to excessive reverse voltages and the peak current in any LED has to be managed so that it is not damaged or forced into a regime where it becomes overdriven and inefficient (current droop).

The first condition can be achieved by several alternate topologies:

- Self-rectifying LED circuits
  - Simple anti-parallel
  - Hybrid bridge structures
- Externally (bridge ) rectified - hvf LED circuits

controlled driver, as here the drive conditions are held static and the LED is operated at a predefined point in its voltage – current characteristic. Such drivers employ complex electronics and also storage devices (particularly electrolytic capacitors) to smooth the pulsed input voltage and deliver a smoothed output Direct Current.

In an AC LED light engine, the pulsed voltage is presented to the LEDs with no electronic storage elements and control is achieved through the careful use of simple (largely non active) components.

The principle control schemes are:

- Ballast Resistor
- Current control components
- Load shaping time domain control chip

The LED topology and the control scheme are very much determined by the AC line voltage. Two types of AC infrastructure are common in various parts of the world:

Line voltage AC – 120V , 230 V being the most common, but with many country and specialized industrial variants.

Line voltage AC LED technology can be either self-rectifying or bridge rectified, but for the reasons discussed below it is generally more effective (higher efficiency) to use a bridge rectified topology where the LEDs are driven in a pulsed DC mode every half cycle. The silicon diode bridge, which occupies about 1.6 V, has hardly any impact on the drive voltage of 120/240 V RMS.

Low voltage AC LEDs are typically self-rectifying because the overhead of a silicon diode bridge rectifier, about 1.6 V, is 15% of the total efficiency of the 12 V system and significantly greater than the efficacy overhead of the self-rectifying topology. Self-rectifying systems are generally less efficient than pulsed DC because the rectifying LEDs are only pulsed every other half cycle and so have to be driven twice as hard to deliver the same power. Hybrid bridge structures are more efficient than simple anti parallel ones because some of the inner dies are driven in the more efficient pulsed DC mode.

There is a class of AC LED “driver” which shapes the current wave form of a bridge rectified line source by switching in banks of LEDs to approximately match the forward voltage to the instantaneous voltage of the AC line. This produces a current wave form more closely matching the voltage source and so improves the power factor (typically from .89 to better than .95) and reduces THD to some extent. The tradeoff for this improvement in performance is a substantial increase in complexity, rendering this approach anything but driver free.

**Figure 2:**  
Basic topologies for driverless LED systems

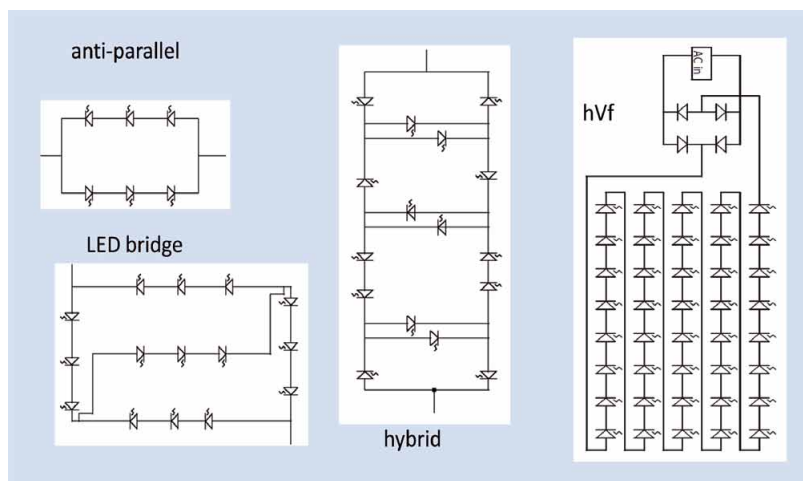

In addition to the LED topology, there is the question of how the current through the system is to be managed. Without some form of control, the nonlinear nature of the LED chain will potentially allow very high currents to flow at the peak of the voltage curve. This is unlike the case of a DC LED (chain) driven by a current or voltage

Low voltage AC – typically 12V or 24V AC from a magnetic or electronic transformer. This is found in external (garden lighting), cove lighting and in linear retail lighting – where the low voltage provides a safe environment around people.

## AC LED Driver-Free Benefits

Removing the DC driver from an LED light engine provides several very significant advantages – apart from the obvious one of eliminating one of the major cost elements in any lamp. A driver free light engine, with substantially fewer components, is smaller, more reliable and dims naturally with the ubiquitous phase cut dimmer.

**Figure 3:**  
Examples par excellence for driverless lamps are festoons or bi-pin capsules, due to a limited space for the electronics



In very small lamps, such as the festoon or the bi-pin capsule, there is no space for electronics if the form and fit of the existing lamp is to be preserved. The low voltage AC festoon replacement is an excellent example of the beneficial tradeoff between self-rectifying LEDs and the inefficient, electronics heavy driver based alternative. At line voltage, the AC LED bi-pin really is the only feasible alternative to the tiny halogen capsule. More generally, however, the real estate released by abandoning a driver, becomes available to increase the convective surface area and so improve the thermal performance of lamps such as the MR16. Even in large lighting fittings such as metal halide replacement spotlights, the removal of

a 40 W DC power supply makes a significant difference size and style of the luminaire.

Driver electronics presents a reliability issue – particularly in the constrained space of small form factor lamps. To compress the electronics into a small space requires compromise on the size and capability of components as well as the sophistication of the design. That coupled with the significant and sustained temperature at which the driver has to operate ( $>80^{\circ}\text{C}$ ) means that reliability and performance can be severely impacted. In larger lamps and fittings, improved reliability is bought at the cost of increased electronics complexity – and \$.

Dimming in the phase cut infrastructure has always presented a challenge to DC drivers, as it works directly against their electronic “smoothing” designed to remove the 50/60 Hz AC waveform from the output. Thanks to some clever and complex drive logic chips, phase cut dimming compatibility is becoming more common in line driven lamps, but not yet in low voltage (halogen) replacement lamps – and certainly not in very small form factor low or line voltage festoons and capsules.

Self-rectifying and external bridge AC LEDs are very well behaved with phase cut dimming. An LED is quite like a resistor (just offset from the voltage zero crossing) and so turns off and on in response to the phase cut dimming voltage waveform. The relationship between the dimmer logic and the LED’s behavior can be a little complex, but the net result is that in the vast majority of conditions, Driverless AC LED light engines dim linearly with leading and trailing edge dimmers provided the minimum load conditions of the dimmer are maintained.

One of the more interesting recent developments from Lynk Labs has been to adapt to operation of AC LEDs in a phase cut dimming environment so that it is possible to design a light engine which shows decreasing color temperature as the phase cut angle increases – this is one refers to as “warm on dim”. Once again the effect – which mimics this often desirable feature of halogen lighting – can be achieved with no electronics, exploiting only the properties of the AC LED structure and the phase cut waveform. AC LED technology attempts to substitute simplicity for complexity in LED lighting.

**Figure 4:**  
Typical dimming curve of AC LEDs on both leading edge or trailing edge phase cut dimmers: Phase cut dimming removes part of the AC waveform by switching on and/or off during each repetition of the 50 or 60 Hz current cycle. If the cycle is held off until switched on, this is leading edge phase cut. If the cycle is switched off part way through, this is trailing edge phase cut

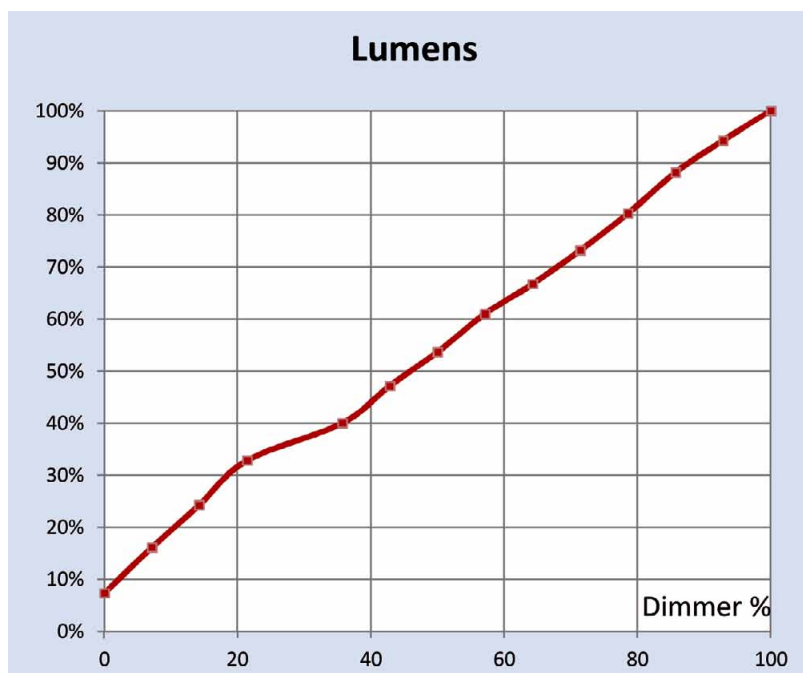

### Efficacy

Efficacy is the measure of efficiency relating to the visible light produced by the electrical power put in. For a DC driven LED, the input power is applied to an electronic AC to DC converter (driver or power supply). This driver has an efficiency loss – typically from 10 to 25% depending on its sophistication (and cost).

In an AC LED, the input power is applied directly to the LED die (possibly via an external rectifier and simple current control component). To measure comparable efficacy, the AC LED must be compared to the complete driver – DC LED system. This is the “plug top” efficacy.

In general a DC LED with a good driver can achieve a plug top efficacy of over 90 lumens/watt, but the typical values in the lamps available today is closer to 65 lm/w leading to lamp efficacies (including optics losses) of 55 lm/w.

For AC LED light engines, a good efficacy today is between 65 and 85 lm/W the lower range being for self-rectifying low voltage and the higher for line driven high voltage LEDs. In many cases the overall efficacy of AC LED based lamps can rival or exceed DC LED lamps.

Additionally, the power factor or the driver (the proportion of the energy input which is applied to real work i.e. generating light or heat) can greatly affect the overall performance of the lamp. The power factor of a small MR16 driver can be as poor as 0.5. An incandescent lamp has a power factor of 1. AC LEDs have a natural power factor close to 0.9 – which is a great deal better than many of the small lamp DC drivers in use today.

Why should AC LEDs have lower efficacy than equivalent DC LEDs? The main reason relates to the period in the AC waveform when there is insufficient voltage to switch the LEDs on. During this part of the cycle the LEDs are producing no light. To compensate they are driven harder than the DC LED during the peak part of the waveform. Getting the balance right is part of the art of designing good AC LED light engines.

However during the peak pulse, the LEDs are moved into a zone of lower efficiency (called current droop) and the overall effect – part off, part on and part on but less efficient – leads to an aggregate efficiency a bit less than the same type of LED driven with constant current to consume the same power. The efficiency deficit between an AC

LED package and a DC LED is typically between 15% and 25%. AC LEDs trade this direct efficiency deficit for the conversion efficiency loss of the power supply or driver.

To close this gap – without resorting to electronic drive technology – two approaches are effective: the simplest is to use more GaN (die). Under driving the AC LED means that the LEDs are not pushed so far into the current droop zone and this brings the effective lm/W much closer to DC LEDs. Since the cost of GaN (i.e. of LEDs) is still falling quickly (Mores Law), this trade off becomes increasingly attractive compared to the (relatively) static cost of the electronics required to drive DC LEDs.

A second and very effective approach is to employ a (passive) current limiting component to cut the peak of the current pulse and hold the LED in a more efficient zone.

With correct current conditioning and a degree of under driving, AC LEDs can perform with almost equivalent efficiency to DC LEDs plus driver electronics and at a lower cost.

### Optical Modulation Effects

An effect of pulse driving AC LEDs (at 2 x the line frequency) is to create optical modulation, which if poorly managed, can become what is popularly known as “flicker”. Can you see an AC LED “flicker”? – Almost certainly not (even in Europe where the fundamental frequency is 100 Hz). What can be perceived is a degree of strobing or “stop motion” when an object is moved quickly in front of an AC LED light source.

There is considerable debate at present whether this is undesirable or largely irrelevant – and a lot depends on the circumstances. For example an indirect AC LED source contributing to a multi light source environment will be completely undetectable, whereas a rotating machine lit by an uncorrected AC LED source could present a hazard to the user if the rotation is frozen.

Optical modulation affects “DC” LEDs since many driver sources also pass through a significant line frequency component. Phase cut dimming also creates a line frequency optical modulation.

To mitigate the effects of modulation, several approaches are possible which do not rely on electronic driver technology. An important concept is the effective modulation frequency – which is proportional to the inverse of the “dark” pulse width. So a 4 ms dark period repeated at 100 Hz is much more visible than a 1 ms dark period at the same frequency. To all intent, as the pulse width of the dark period is reduced, its effect is equivalent to increasing the modulation frequency. With a frequency over 250 Hz, most modulation effects are completely undetectable. This means one can remove most of the effects of line frequency modulation by reducing the dark pulse period to less than 2 ms.

To reduce the effects of optical modulation one looks to decrease the time width of the period when the LEDs are in their off state by filling the optical gap with stored energy – either from photonic stored light energy – long latency phosphor for example; or electrically stored energy – using a capacitor or a resonant circuit. These photonic and electronic solutions are still largely in development but they will supply good solutions to the modulation challenge in the very near future.

### Cost

One of the critical arguments in favor of AC LED technology is the removal of the cost of an electronic driver. AC technology is naturally dimmable and has a power factor of about 0.9.

To achieve similar efficacy and lumens with an AC LED light engine, additional die will be needed and this offsets to some extent the savings from the removal of electronics. Additionally there is a minimal set of control components required for properly conditioned AC drive. The overall the tradeoff comes out in favor of AC LEDs – particularly for smaller lamps and for low voltage systems. The offsetting

cost of additional die and control components is about 30% of the electronics at high volume – so for many applications there are very useful cost improvements to be made with AC LEDs.

There is of course, a lot more than the raw Silicon and GaN cost to compare. The future cost trends favor substituting Silicon electronics with additional GaN die which are still reducing more rapidly in cost. AC LED light engines require little (or in the case of some Chip-on-Board packages – no) additional electronics assembly during lamp manufacture and this simplification results in a lower cost of production.

### The AC LED Patent Landscape

The IP surrounding AC LED technology can be compared to the phosphor patents or RGB control patents for LEDs. Both, phosphors and RGB control methods were leveraged by key players into the market as patented enabling technologies for LEDs as LEDs started to increase market penetration in the world of lighting. AC LEDs seem to fall within a similar category of enabling technology as they provide a more simplified method of interfacing LEDs to the existing AC voltage global infrastructure and with less complexity than DC LED solutions.

Many people misunderstand AC LED technology and view it as a driver based technology but this is far from accurate. There are patented drive methods and solutions behind AC LED technology but it is the AC LEDs circuits, chips and packages that are at the root value.

One fundamental difference between AC LED and DC LED technology in relation to IP is that AC LED circuits sit under core IP owned by several key players whereas DC LED circuits are an open architecture. Making series, parallel or series parallel DC LED circuit can be done without violating any circuit level IP and is basically an open architecture. Most of the IP here sits at the materials, chips, packages, drivers and systems.

For AC LEDs however, the IP falls in these same areas but also includes fundamental enabling AC LED circuits thereby taking the IP landscape to a whole new level of complexity. This is because AC LEDs are more like integrated circuits that are designed to match existing lighting infrastructure AC voltage sources in one form or another. As a result, various forms of low voltage and high voltage AC LED circuits sit under key enabling patents owned by only a few players.

The pioneers of today's rapidly growing AC LED industry are Lynk Labs and Seoul Semiconductor who hold a reasonable amount of the core IP in the AC LED space. Both of these companies basically launched the AC LED industry.

Later Epistar joined in through collaboration with ITRI and Lynk Labs and developed various single chip AC LED products. More recently, Philips Lumileds entered the High Vf part of the market and Samsung is now promoting a line drive component for high voltage AC LED applications. Cree and several others have also recently introduced high Vf products, some of which do and don't fall under the simple high Vf rectified segment of AC LED technology.

This new and accelerated participation of more manufacturers entering the market demonstrates that AC LEDs are here to stay and heading towards becoming a serious contender to their DC counterparts. AC LED technology enables integrating LEDs into the existing general lighting infrastructure in a whole new way; it is likely that the IP position for AC LEDs from circuit to end system level will play a key role as the market starts to evolve.

### Conclusions

Driverless AC LED technology can deliver savings and benefits in the design of lamps for both low and line voltage applications. The emergence of this simple approach to applying LEDs for mainstream lighting will change the dynamics of the industry by placing less emphasis on electronics in everyday lighting products. As GaN becomes cheaper, the cost advantage will help accelerate the adoption of AC LED lighting in the very high volumes cost sensitive markets. Simplified manufacturing and assembly will contribute to that momentum.

The challenges of efficacy and optical modulation effects are real but diminishing: as GaN reduces in cost, \$ per kilo lumen falls and the cost of enhancing package efficacy through the use of additional die diminishes further. Optical modulation, which in many instances presents no issue for lighting applications, is being addressed on several technical fronts.

The reliability, dimming and space saving benefits of Driverless AC technology add significant value to the use of AC LEDs in the emerging volume lighting markets, ensuring AC LEDs will have an important role to play in the growth of energy efficient affordable lamps and fixtures. ■



# guangzhou international lighting exhibition

# 17<sup>th</sup>

9 – 12 June 2012

China Import and Export Fair Complex  
Guangzhou, China

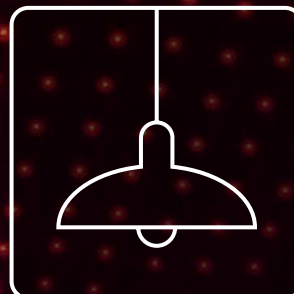
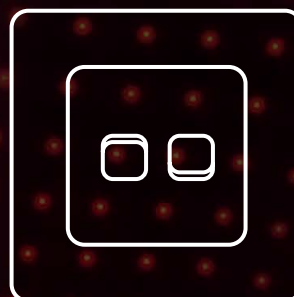

#### Show highlights:

- The most influential and comprehensive lighting and LED industry event
- 6 theme zones covering full spectrum of lighting products and LED technologies
- Over 200,000 sqm spanning 21 halls, featuring more than 2,700 exhibitors in 2012
- 2011 show attracted 100,465 visitors from 116 countries and regions

For more information, please contact  
Tel: (852) 2802 7728 Fax: (852) 2598 8771  
Email: LBguangzhou@hongkong.messefrankfurt.com  
www.light.messefrankfurt.com.cn



messe frankfurt

# Thermal Considerations for Driving LED Strings with CCRs

Constant Current Regulators (CCRs) controlling current in solid-state lighting applications must be considered within the overall system thermal design to ensure reliability and consistent performance. Steve Sheard, Strategic Programs Manager for Standard Products at ON Semiconductor discusses in detail why this is so important.

Low-cost and simplified control techniques are needed to encourage adoption of LED technology in applications such as domestic replacement bulbs or automotive interior and exterior lamps. Supplying the LED – or series-connected string in a multiple-LED system - with a constant forward current is the preferred means of ensuring consistent luminosity and preventing damage to the LEDs caused by over driving.

A resistor in series with the LED string is the simplest means of regulating the current, but there are a number of shortcomings. The resistor has relatively high power dissipation, which reduces overall efficiency and generates significant heat. In addition, the resistor provides no protection against voltage variations, which can affect the light generated. Very high voltage transients are capable of damaging the LEDs.

A Constant-Current Regulator (CCR) based on a self-biasing transistor can provide a cost-effective and straightforward means of supplying a regulated current to the LED string, avoiding many of the drawbacks of a pure series resistor. The CCR also has a negative current-versus-temperature characteristic as ambient temperature increases, which provides protection against thermal runaway. It is a popular solution in applications where the applied voltage can vary over a wide range, such as domestic lamps and automotive lighting.

A number of CCR variants are available, such as two-terminal devices that regulate the LED current to a preset value or three-terminal devices that allow the current to be programmed using one external resistor. Built-in surge suppression provides inherent over-voltage protection for the LEDs.

In addition to its simplicity, the CCR is also a versatile solution since it can be used as a high-side or low-side regulator; automotive applications often require a high-side device as the LED low-side connection is typically grounded directly to the vehicle body. Figure 1 illustrates a generic CCR-controlled LED lighting circuit.

## Thermal Management in LED-lighting Design

For good CCR implementations, close attention to the thermal management is essential throughout the design. The

designer must consider thermal effects not only on the LEDs and associated passive components such as electrolytic capacitors but also on the CCR itself since the regulator conducts the full LED driving current; the power dissipated within the device cannot be ignored.

Although high-power LEDs operate significantly more efficiently as light sources than incandescent lamps, a significant proportion of energy supplied is converted into heat. Inadequate thermal design will allow this heat to produce a temperature rise in the LED, which can have a number of unwanted effects. The luminosity of an LED emitter decreases as the semiconductor junction temperature increases. The LED can be destroyed if the junction temperature exceeds the manufacturer's stated maximum; usually 150°C.

Changes in temperature can also alter the wavelength of light emitted by coloured LEDs, or the Corrected Colour Temperature (CCT) of white LEDs, producing noticeable changes in lighting. Moreover, as with any other semiconductor device, reliability is impaired by prolonged operation at elevated temperatures. In LEDs, this can be measured as a reduction in light output over time.

The change in light output with time, in relation to initially measured output, is quantified in terms of lumen maintenance. This is used to define the useful lifetime of an LED lamp, and

**Figure 1:**  
Generic CCR-controlled LED lighting circuit

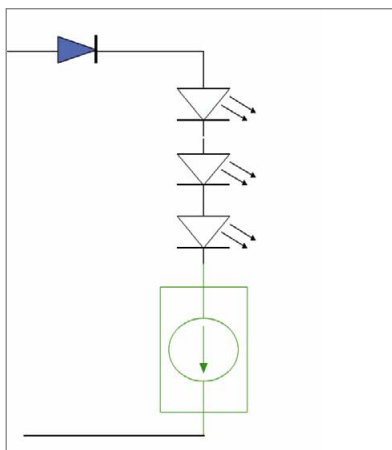

compares with the time to failure of a conventional incandescent lamp which tends to dim gradually before failing completely. Since LEDs generally do not fail catastrophically, end of life can be determined as the point at which luminosity has fallen below an acceptable level. For most applications this is accepted to be around 70% of the initial light output, or 80% in applications where a small reduction may be highly noticeable.

LED manufacturers may publish graphs relating lumen output, temperature and drive current for a given emitter type, enabling designers to predict the lifetime after which the light output will have fallen below 70% of its initial value (L70) or below 80% (L80). These graphs enable lighting designers to determine the optimum current and operating temperature to guarantee the required light output up to the target lifetime. This information can then be used to determine the

drive characteristic, total number of LEDs required and thermal design to meet system-level requirements including size and cost.

Designers must consider all of these effects when determining the number and type of LEDs to be used, the drive conditions and the heat sinking provided. Some LED manufacturers publish design guides that include recommendations such as PCB substrate type or metallisation beneath and around the device. The thermal design of the PCB has an important role in helping to extract heat from the LED junction, through the package and into the ambient, to maintain a stable operating temperature under given driving conditions.

The heat generated by the LED array is a major factor determining the temperature of the lamp assembly as a whole, and can strongly influence the surrounding ambient temperature if the

lamp is to be used in a confined space. Hence, in addition to calculating the lifetime of the LEDs, designers must also ensure the surrounding electronic components are capable of operating for the intended lifetime of the lamp. Factors to consider include thermal effects on electrolytic capacitors in the rectifying or voltage regulation circuitry. Operation at high temperatures results in drying of liquid electrolyte, producing a loss of capacitance. Hence capacitors may need to be derated according to the datasheet, to guarantee the minimum required capacitance over temperature and time.

### Thermal Management of CCR Controller

In a CCR-controlled system the full LED drive current flowing in the regulator can produce significant self heating. Hence the thermal performance of the system around the regulator requires careful consideration. A key parameter is the quantity of heatsinking provided, such as the area and thickness of copper on the PCB, or whether to specify a thermally enhanced substrate. The graphs shown in figure 2 demonstrate how power dissipation falls as the ambient temperature increases. The traces show performance with a variety of substrate characteristics. These graphs are published in CCR datasheets, and can be used to guide device selection and PCB design.

For a series circuit, the maximum power dissipated by the CCR is determined by:

$$P_D = (V_{source} - (V_{LEDS} + V_{RPD})) \times I_{reg}$$

where  $V_{RPD}$  is the voltage across the reverse-battery protection diode, where included.

Worst-case values should be used when calculating  $P_D$  for thermal design purposes. That is, the highest  $V_{source}$ , lowest LED  $V_f$ , and highest target  $I_{reg}$ . Note that the power dissipation can be reduced for a pulse-width modulation controlled circuit.

**Figure 2:** Power dissipation versus ambient temperature for CCR in SOD123 package, for a variety of copper heat-spreader specifications

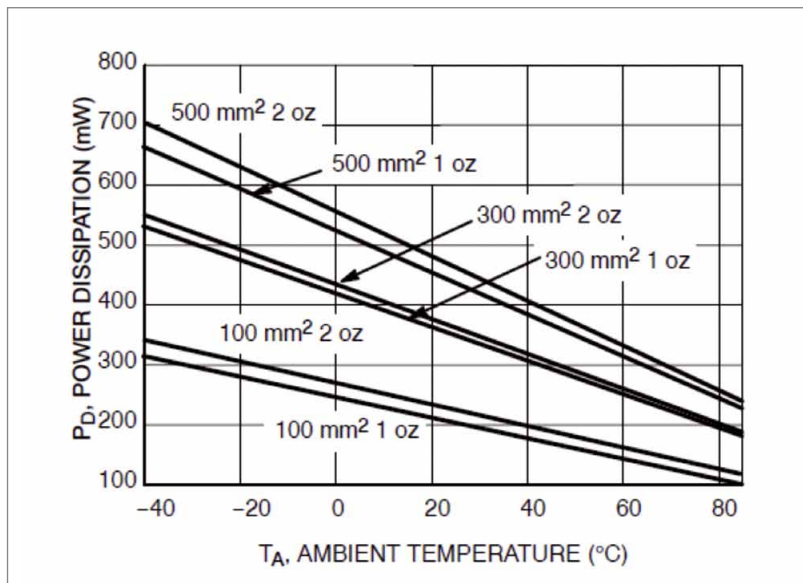

**Figure 3:** CCR in high-side circuit of automotive LED-lighting unit

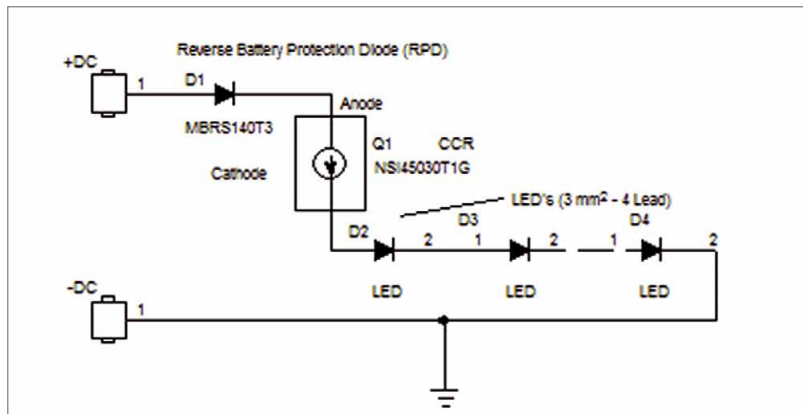

**Figure 4:**  
Power dissipation versus ambient temperature for CCR in SOT-223 package

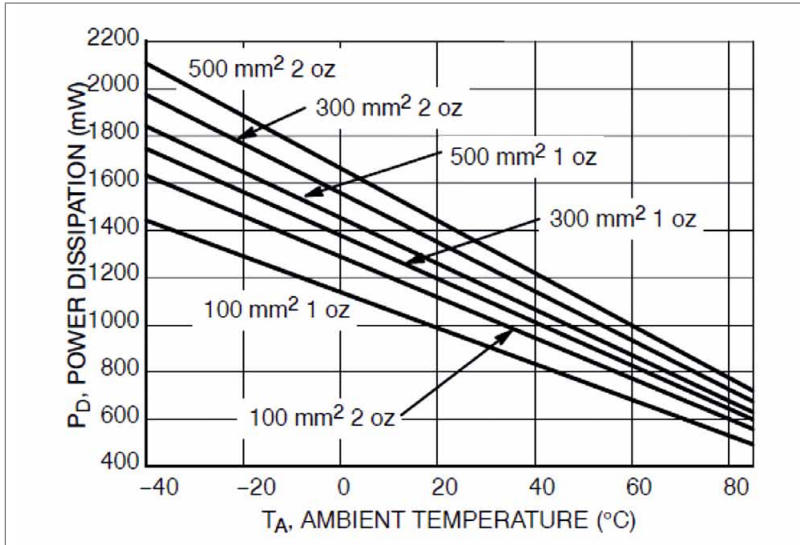

Consider the example of an automotive light unit comprising three red LEDs in series, as shown in figure 3. Assuming a maximum supply voltage of 16 V from the vehicle regulator, and worst-case forward voltage  $V_F$  of  $2.0 V_{dc}$  for each LED,  $0.2 V_{dc}$  forward voltage of the Schottky diode, the maximum power dissipated in the CCR can be calculated:

$$P_D = (16 V_{dc} - (3 \times 2.0 V_{dc}) + 0.2 V_{dc}) \times 30 \text{ mA} = 294 \text{ mW}$$

If designing for an ambient temperature of  $85^\circ\text{C}$ , figure 2 shows that the CCR in a SOD-123 package requires the substrate to have more than  $500 \text{ mm}^2$  of copper. In contrast,

figure 4 indicates that the required PD can be met using  $100 \text{ mm}^2$  of 1oz copper using an equivalent CCR in a SOT-223 package. The SOT-223 has lower thermal resistance ( $R_{\theta ja}$ ) than the SOD-123. In practice, the size constraints of the application may in fact allow for a larger surface area. Figure 3 shows that a SOT-223 CCR mounted on  $300 \text{ mm}^2$  of 1oz copper is capable of dissipating 598 mW, thereby satisfying the worst-case requirement and providing some safety margin.

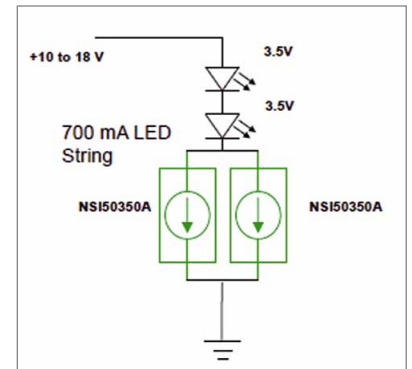

**Figure 5:** Two CCRs can be connected in parallel for higher current applications

# euroLED™ 2012

SHOWCASING CUTTING EDGE LED AND SOLID STATE LIGHTING

TAKING PLACE ON 13th & 14th JUNE 2012

AT THE NEC, BIRMINGHAM, UK



## EXPERIENCE THE WORLD OF LEDs:

- Network with global decision makers from the LED industry
- Discover the whole LED supply chain on the exhibition floor
- Gain insight from international market leaders including Nichia, Philips, Osram, GE Lighting at the technical conference

Register Now



## Contact Us:

www.euroLED.org.uk  
 Twitter: @euroLED  
 LinkedIn: euroLED2012  
 T: +44 (0) 121 250 3515  
 E: info@euroLED.org.uk

For applications requiring extremely high brightness, such as automotive exterior lighting or commercial signage, devices such as the NSI50350A in the DPAK power package are able to carry load current of up to 350 mA. In addition, two CCRs can be connected in parallel to allow further increases in current-handling capability. By splitting the total power between two CCRs, the thermal effect can be spread over a larger area and less concentrated.

The circuit of figure 5 shows two NSI50350A CCRs connected in parallel to maintain constant drive current of up to 700 mA through two high-power white LEDs. In this example, the CCRs are connected to the low side of the LED string. The power dissipated by each CCR is determined by:  $(V_{source} - V_{LEDS}) \times I_{REG}$ .

Using the worst case scenario combining the highest  $V_{source}$ , lowest LED  $V_F$  and highest target  $I_{REG}$ , an 18 V source driving two white LEDs with a  $V_F$  of 3.5 V and 350 mA  $I_{REG}$  would require maximum dissipation of:

$$P_D = (18 V - (2 \times 3.5 V)) \times 0.350 A = 11V \times 0.35 A = 3.85 W \text{ for each CCR}$$

If the ambient temperature is to be 85°C, the required dissipation cannot be achieved with standard FR4 PCB. The graph of figure 6 shows how the DPAK devices performs with a thermally enhanced substrate. By combining each DPAK with 900 mm<sup>2</sup> of 2oz copper metal-clad PCB (MCPCB) the requirement to operate up to 3.85 W at an ambient temperature of 85°C will be satisfied.

**Conclusion**

Constant Current Regulators provide accurate regulation and reduced design complexity in high-power LED applications ranging from signage to automotive lighting. Although they are a popular solution, capable of ensuring consistent luminosity under varying voltage conditions, the power dissipated in the CCR itself is an important factor in the thermal design of the system. In the same way that designers should ensure adequate PCB thermal performance around the power LEDs, as recommended by the LED manufacturer, they must also calculate the optimum combination of CCR package and substrate metallisation to prevent the CCR from overheating. ■

**Figure 6:** Power dissipation versus ambient temperature for DPAK CCR on thermally enhanced PCB

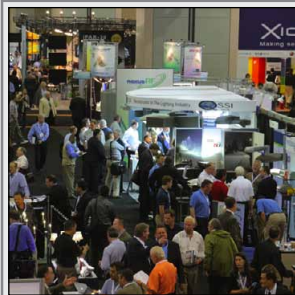
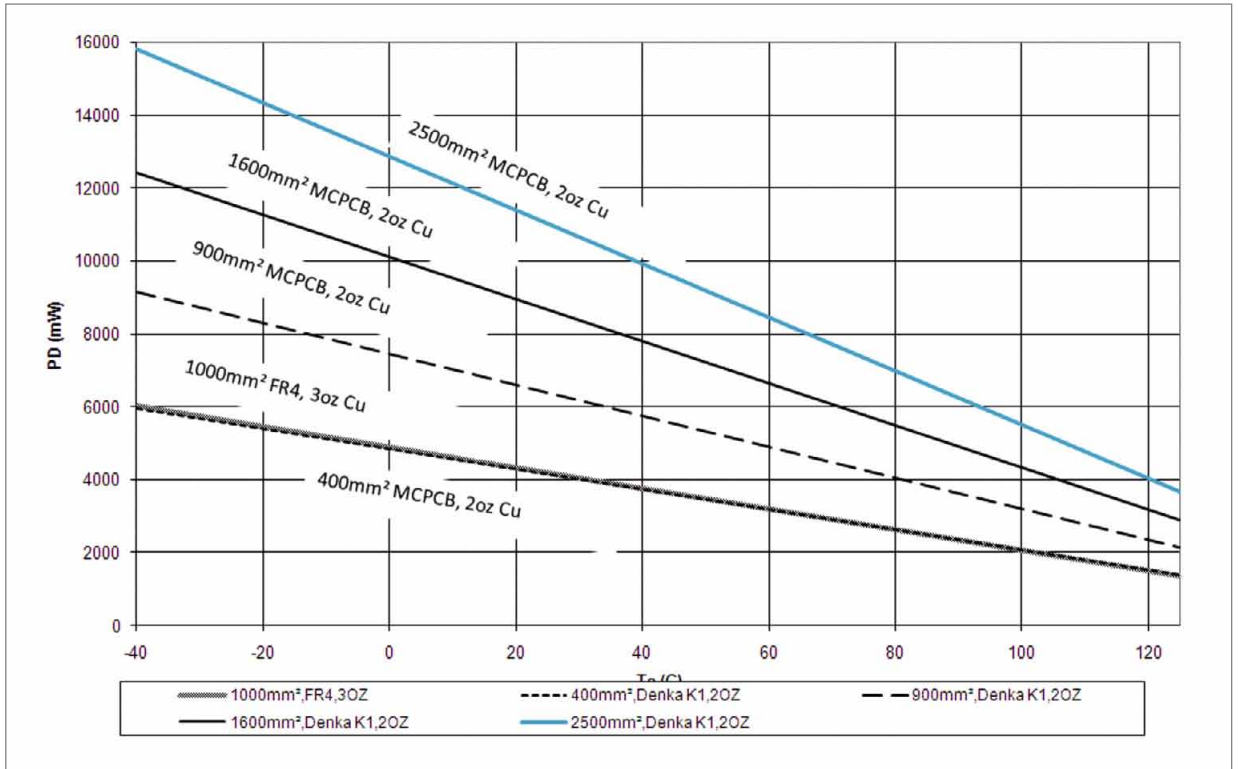

**LIGHTFAIR INTERNATIONAL**

LIGHTFAIR® International (LFI) is the world's largest annual architectural and commercial lighting trade show and conference. LFI is the premier event for lighting, energy, design and architecture professionals from around the world, connecting innovative design, cutting-edge technology and continuing education courses.

The LIGHTFAIR Daylighting Institute® and the LIGHTFAIR Institute® took place as part of the Pre-Conference program on Monday, May 7 – Tuesday, May 8, 2012 and the LFI Trade Show and Conference was run Wednesday, May 9 – Friday, May 11, 2012.

# Imprint

LED professional Review (LpR), ISSN 1993-890X

## Publisher

Luger Research e.U.

Institute for Innovation & Technology  
LED professional Dept.  
Moosmahdstrasse 30  
A 6850 Dornbirn, Austria / Europe

phone +43 5572 394 489  
fax +43 5572 394 489 90  
editors@led-professional.com  
www.led-professional.com

## Publisher

Siegfried Luger

phone +43 5572 394 489  
s.luger@led-professional.com

## Editor-in-Chief

Arno Grabher-Meyer

phone +43 5572 394 489-18  
a.g-m@led-professional.com

## Int. Account Manager

Theresa Koenig

phone +43 5572 394 489-20  
theresa.koenig@led-professional.com

## Promotion & Sales Mgr.

Gerlinde Graf

phone +43 5572 394 489-43  
gerlinde.graf@led-professional.com

## Cover-page

Image: Arno Grabher-Meyer, LED professional; Verbatim Color Tunable OLEDs  
Artwork: Thomas Klobassa, ©LED professional 2012

## Copyrights – Luger Research e.U.

The editors make every reasonable effort to verify the information published, but Luger Research e.U. assumes no responsibility for the validity of any manufacturers, non profit organisations or individuals claims or statements. Luger Research e.U. does not assume and hereby disclaims any liability to any person for any loss or damage caused by errors or omissions in the material contained herein, regardless of whether such errors result from negligence, accident or any other cause whatsoever. You may not copy, reproduce, republish, download, post, broadcast, transmit, make available to the public, or otherwise use LED professional Review (LpR) content without prior written consent from Luger Research e.U. – Institute for Innovation & Technology, Austria. ■



## LED professional Review (LpR) - Annual Subscriptions

### LpR Digital Magazine

- 6 issues
- pdf download
- high resolution pictures and graphs
- printable
- commercial use
- access to all previous issues
- Euro 78.80

<http://www.led-professional.com/subscription>

### LpR Printed Magazine

- 6 issues
- Euro 158.40

Next LpR Issue - July/Aug 2012

Methods, Processes & Devices

**LED** SYMPOSIUM  
professional +EXPO  
LpS 2012

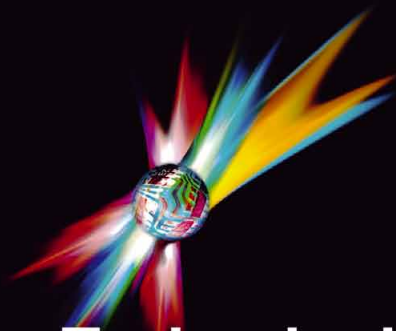

**LED Lighting Technologies**  
International Winning Approaches

**25-27 SEPTEMBER 2012  
BREGENZ | AUSTRIA**

PROGRAM AVAILABLE  
EARLY BIRD  
REGISTRATION  
OPEN NOW!  
[www.lps2012.com](http://www.lps2012.com)

#### CONTACT:

LUGER RESEARCH | Moosmahdstrasse 30 | 6850 Dornbirn  
T +43 5572 39 44 89 | F +43 5572 39 44 89 90  
[info@lps2012.com](mailto:info@lps2012.com) | [www.lps2012.com](http://www.lps2012.com)

**e:lumix**  
Technologie AG

**OSRAM**  
Opto Semiconductors

**TRIDONIC**  
enriching your ideas



# WE ARE LIGHT

## EBV ELEKTRONIK AND OSRAM OPTO SEMICONDUCTORS

OSRAM Opto Semiconductors appointed Avnet EM as 'Preferred Global Partner'.  
EBV Elektronik is representing this 'Preferred Global Partnership' in EMEA.

To get the best from LED technology, you need the right partners with the appropriate expertise and the ideal product range.  
This is where our customers benefit from the partnership of the EBV LightSpeed team and OSRAM Opto Semiconductors.  
With more than 30% market share according to DMASS, EBV is the leading specialist for optoelectronics  
technology in EMEA semiconductor distribution.

Together with OSRAM Opto Semiconductors innovative, trend-setting technologies for illumination, visualisation and sensing we  
will offer you full support in turning your lighting ideas into reality.

With the EBV LightLab, EBV is the first company in EMEA semiconductor distribution, to offer customers all over EMEA to perform  
photometric measurements and analyse their lighting projects. The complete spectrum of products from individual LEDs right up to  
the complete luminaires are covered in the EBV LightLab. More info under [ebv.com/lightlab](http://ebv.com/lightlab).

For all services around LED technology from OSRAM contact your local partner of the EBV LightSpeed team.



# Fortimo LED Systems for today, for tomorrow

Let's talk about LED Systems outperforming T5  
With energy efficiency levels up to 135 lm/W. What about quality of  
light and design? Join the discussion at our LinkedIn group, LED Tech Talk.



Fortimo LED Line System

**PHILIPS**  
sense and simplicity